



LINGO SHELVING SYSTEM

EUR PRICE LIST
01.01.2024



LINGO SHELVING

You will find exceptional versatility with the functional and flexible Lingo Shelving System.

It encapsulates the true meaning of flexibility. Its modular construction provides the highest degree of functionality and versatility and its style and quality makes it suitable for both contemporary and classic library environments.

The Lingo shelving system offers endless possibilities of function and design. The construction of the shelving system, with 25 mm increments, allows for easy assembly and adjustment without the use of specific tools.

Lingo is available as a single- or double-sided shelving, with or without castors, and as a straight, curved or combined solution. It can be fitted with steel or wooden shelves, as well as a wide variety of other functional components. The result – a customisable shelving systems that fits the requirements of your specific library.

You will find all the standard products in this overview. For additional inspiration we invite you to visit our website where you can find project inspiration from our latest projects around the world. Our professional sales team is ready to help you with any questions you may have.



The price list is valid from 01.01.2024 until 31.12.2024.

Conditions of sale and terms of delivery

All prices are excluding VAT and delivery. Please see our conditions of sale and terms of delivery on our website.

Updating the price list

The price list will continually be updated and can be downloaded on our website. Please contact our sales office, who will forward a log-in and password via e-mail. We reserve the right to make product and price alterations without prior notice and accept no liability for printing errors.



INDEX

FSC ®	4
DESIGN OPTIONS	6
TECHNICAL SPECIFICATIONS	10
DIMENSIONS	20
BAY CONSTRUCTION	24
STRAIGHT AND ROUND COMBINATIONS	28

STRAIGHT CONFIGURATIONS

BBN001 - WITH ADJUSTABLE FEET, FOR TOP SHELF

Single-sided configurations with back frame	30
Double-sided configurations with back frame.....	32
Single-sided configurations with high wooden back panel....	38
Double-sided configurations with high wooden back panel ..	40
Single-sided configurations with low wooden back panel.....	44
Double-sided configurations with low wooden back panel....	46
Single-sided configurations with cross brace.....	50
Double-sided configurations with cross brace.....	52

BBN002 - WITH ADJUSTABLE FEET & TOP PLATE

Single-sided configurations with back frame	56
Double-sided configurations with back frame.....	62
Single-sided configurations with wooden back panel.....	70
Double-sided configurations with wooden back panel.....	76
Single-sided configurations with cross brace.....	84
Double-sided configurations with cross brace.....	90

BBN011 - WITH CASTOR PLATE, FOR TOP SHELF

Double-sided configurations with back frame.....	98
Double-sided configurations with wooden high back panel	104
Double-sided configurations with wooden low back panel..	110
Double-sided configurations with cross brace.....	116

BBN012 - WITH CASTOR PLATE & TOP PLATE

Double-sided configurations with back frame.....	122
Double-sided configurations with wooden back panel.....	128
Double-sided configurations with cross brace.....	134

LINGO SQUARE

With plint.....	138
With castors	140

COMPONENTS FOR STRAIGHT SHELVING

CHECK LIST

SHELVES

S1, S2, S3, S4 - steel shelves.....	144
ST1, ST2, ST3 - steel top shelves	156
W1, W2, W3, W4 - wooden shelves	166
WT1, WT3 - wooden top shelves.....	174
WO1 - wooden overlaying top plates.....	179
Display and storage	186

ACCESSORIES

Steel browsers	188
Wooden browsers.....	194
Display and storage	195
Book supports.....	200
Signage for front of shelf.....	202
Signage for end panel.....	204

CASTORS & PLINTHS

Visible castors.....	207
Hidden castors.....	207
Castor plates	208
Plinths.....	209

PANELS

With adjustable feet/for castor frame:

Single-sided wooden panels - for top shelf.....	210
Double-sided wooden panels - for top shelf	212
Double-sided slat wooden panels - for top shelf.....	213
Single-sided wooden panels - for overlaying top plate	214
Double-sided wooden panels - for overlaying top plate	216
Double-sided slat wooden panels - for overlaying top plate ..	217

For castor plate:

Double-sided wooden panels - for top shelf	218
Double-sided slat wooden panels - for top shelf.....	219
Double-sided wooden panels - for overlaying top plate	220
Double-sided slat wooden panels - for overlaying top plate ..	221

End panel bay

End panel bay	222
Components for end panel bay.....	223

CONNECTION ELEMENTS

Wooden back panels	224
Steel frame.....	226
Cross frame.....	227

LIGHTING

Book Big lighting.....	228
------------------------	-----

ROUND CONFIGURATIONS

BBN201 - 26° WITH ADJUSTABLE FEET, FOR TOP SHELF	
26° - back frame	232
26° - high steel back panel	236
26° - low steel back panel	240
BBN202 - 26° WITH ADJUSTABLE FEET & TOP PLATE	
26° - back frame - freestanding section	244
26° - back frame - left starter section.....	245
26° - back frame - right starter section	246
26° - back frame - intermediate section	247
26° - back frame - left end section	248
26° - back frame - right end section.....	249
26° - steel back panel - freestanding section	252
26° - steel back panel - left starter section.....	253
26° - steel back panel - right starter section	254
26° - steel back panel - intermediate section	255
26° - steel back panel - left end section	256
26° - steel back panel - right end section.....	257
BBN211 - 26° WITH CASTOR PLATE, FOR TOP SHELF	
26° - back frame - freestanding section	260
26° - high steel back panel - freestanding section	264
26° - low steel back panel - freestanding section	268
BBN212 - 26° WITH CASTOR PLATE & TOP PLATE	
26° - back frame - freestanding section	272
26° - steel back panel - freestanding section	276
BBN221 - 18° WITH ADJUSTABLE FEET, FOR TOP SHELF	
18° - back frame	280
18° - high steel back panel	284
18° - low steel back panel	290
BBN222 - 18° WITH ADJUSTABLE FEET & TOP PLATE	
18° - back frame - freestanding section	292
18° - back frame - left starter section.....	293
18° - back frame - right starter section	294
18° - back frame - intermediate section	295
18° - back frame - left end section	296
18° - back frame - right end section.....	297
18° - steel back panel - freestanding section	300
18° - steel back panel - left starter section.....	301
18° - steel back panel - right starter section	302
18° - steel back panel - intermediate section	303
18° - steel back panel - left end section	304
18° - steel back panel - right end section.....	305
BBN231 - 18° WITH CASTOR PLATE, FOR TOP SHELF	
18° - back frame - freestanding section	308
18° - high steel back panel - freestanding section	312
18° - low steel back panel - freestanding section	316
BBN232 - 18° WITH CASTOR PLATE & TOP PLATE	
18° - back frame - freestanding section	320
18° - steel back panel - freestanding section	324

COMPONENTS FOR ROUND SHELVING

CHECK LIST	327
SHELVES	
S5, S6 - steel shelves	328
W5, W6, W7, W8 - wooden shelves	334
WT5, WT7 - wooden top shelves	340
WO5 - wooden overlaying top plates.....	344
CASTORS & PLINTHS	
Visible castors.....	347
Hidden castors.....	347
Castor plates	348
Plinths.....	349
PANELS	
With adjustable feet/for castor frame:	
Double-sided wooden panels - for top shelf	350
Double-sided wooden panels - for overlaying top plate	352
For castor plate:	
Double-sided wooden panels - for top shelf	354
Double-sided wooden panels - for overlaying top plate	360
End panel bay	
End panel bay	358
Components for end panel bay.....	359
CONNECTION ELEMENTS	
Steel back panels.....	360
Steel frames.....	362



WOOD FROM SUSTAINABLE MANAGED FORESTRY

We are committed to increasing the share of sustainable raw wooden material in our products and thereby support responsibly managed forests – for a better world.

Governments and local authorities are specifying the supply of legal and responsibly sourced wood in their procurement policies.

We have invested in a Chain-of-Custody Multi-site certificate (FSC-C144988), issued by FSC, which documents, that we can offer wood from responsibly managed forests. FSC® (Forest Stewardship Council) is an international labeling scheme, that documents that FSC labelled products originate from sustainable forestry.

Working with certified suppliers, we can now offer all painted and veneered components as fully FSC Mix certified (noted in this document at the top of each page showing wooden components).



What is sustainable managed forestry?

According to the FSC, forests, managed according to their principles and criteria, mean fair conditions for workers, respect for indigenous communities and local populations as well as strict environmental controls.

The FSC label guarantees that the trees that are harvested are replaced or allowed to regenerate naturally.

The FSC label also guarantees that all the wood is tracked from the forest to the store. Every link between the forest and the consumer is certified to make it clearly identifiable which wood is from sustainable forestry and which is not.

Source: Forest Stewardship Council
<http://www.fsc-uk.org/en-uk>

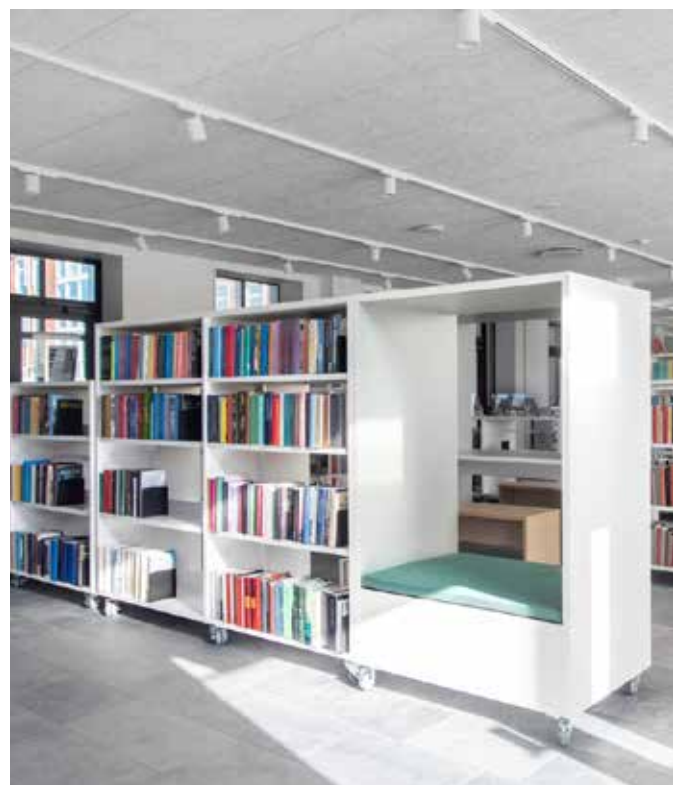

DESIGN OPTIONS

STEEL COMPONENTS - PAINTED

A PRICE GROUP - BASIS PRICE (smooth finish)



A03
Traffic white
RAL 9016
Gloss 75-90



A02
Oyster white
RAL 1013
Gloss 40-50

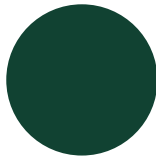

A22
Moss green
RAL 6005
Gloss 71-85



A26
Fir green
RAL 6009
Gloss 71-85

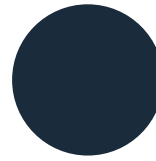

A12
Steel blue
RAL 5011
Gloss 71-85

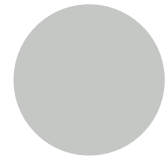

A13
Light grey
RAL 7035
Gloss 71-85

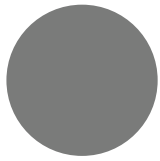

A15
Dusty grey
RAL 7037
Gloss 71-85

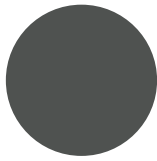

A16
Traffic grey
RAL 7043
Gloss 71-85

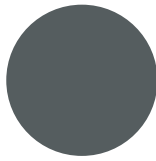

A17
Basalt grey
RAL 7012
Gloss 71-85

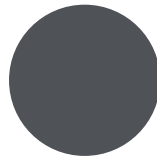

A18
Slate grey
RAL 7015
Gloss 71-85

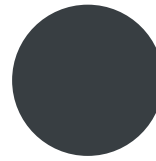

A19
Anthracite grey
RAL 7016
Gloss 71-85

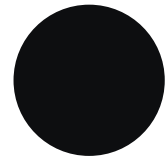

A25
Jet black
RAL 9005
Gloss 71-85

B PRICE GROUP - BASIS PRICE WITH 7% SURCHARGE (smooth finish)



A01
Pure white
RAL 9010
Gloss 71-85

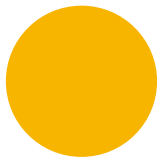

A04
Traffic yellow
RAL 1023
Gloss 71-85

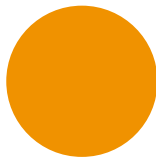

A05
Sun yellow
RAL 1037
Gloss 71-85

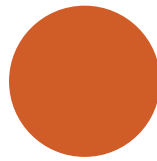

A06
Signal orange
RAL 2010
Gloss 71-85

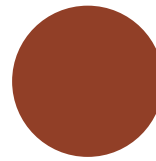

A07
Pearl orange
RAL 2013
Gloss 65-85

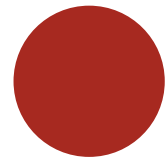

A08
Flame red
RAL 3000
Gloss 71-85

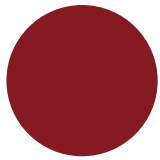

A09
Ruby red
RAL 3003
Gloss 71-85



A21
Reseda green
RAL 6011
Gloss 71-85

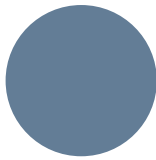

A10
Pigeon blue
RAL 5014
Gloss 71-85

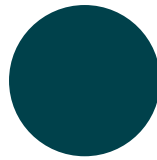

A11
Ocean blue
RAL 5020
Gloss 71-85

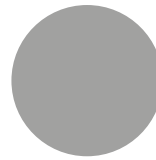

A14
White aluminium
RAL 9006
Gloss 50-70

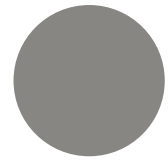

A31
Grey aluminium
RAL 9007
Gloss 50-70

B PRICE GROUP - BASIS PRICE WITH 7% SURCHARGE (textured finish)



A27
Pure white
RAL 9010

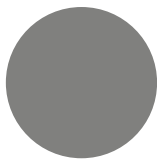

A29
Concertina grey

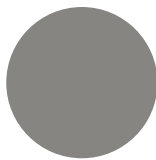

A28
Grey aluminium
RAL 9007

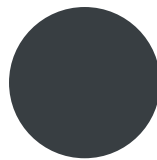

A23
Anthracite grey
RAL 7016

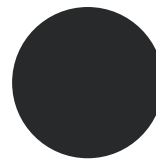

A24
Graphite black
RAL 9011

Note:

- Other RAL/NCS colours have a starter fee of GBP 215 / EUR 250 and a surcharge of 15%. A higher surcharge for colours with "metallic" look or different surface textures must be expected.
- See specific colour for steel gloss specification. Special requests outside specified gloss range are not covered by the above surcharges.
- Chrome, electro galvanised and aluminium parts are not available in other colours.
- Products such as e.g. castors and accurides cannot be produced in other colours than described in the price list.

DESIGN OPTIONS

WOODEN COMPONENTS - MELAMINE/LAMINAT

A PRICE GROUP - BASIS PRICE

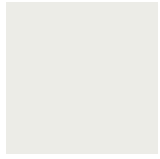

D61/L61
Signal white
RAL 9003

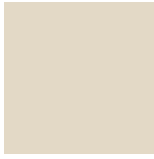

D72/L72
Oyster white
Similar to RAL 1013

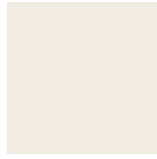

D62/L62
Pure white
Similar to RAL 9010



D63/L63
Steel blue
RAL 5011



D71/L71
Dusty grey
Similar to RAL 7037



D16/L16
Basalt grey
Similar to RAL 7012



D19/L19
Slate grey
Similar to RAL 7015 and
RAL 7016



D04/L04
Beech decor



D05/L05
Maple decor



D06/L06
Cherry decor



D07/L07
Oak decor



D08/L08
Olive decor

C PRICE GROUP - BASIS PRICE WITH 10% SURCHARGE



D64/L64
Signal yellow
RAL 1003



D65/L65
Yellow orange
RAL 2000



D66/L66
Pure orange
RAL 2004



D67/L67
Traffic red
RAL 3020



E02/L02
Ruby red
Similar to RAL 3003



D13/L13
Lime green
Similar to NCS S1060-G40Y



D68/L68
Reseda green
Similar to RAL 6011

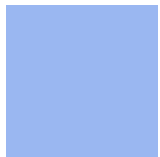

D14/L14
Crystal blue
Similar to NCS S1020-R90B



D73/L73
Pigeon blue
RAL 5014



D74/L74
Ocean blue
Similar to RAL 5020

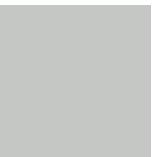

D69/L69
Light grey
Similar to RAL 7035



D70/L70
White aluminium
Similar to RAL 9006



D75/L75
Jet black
Similar to RAL 9005

Note:

- The above selection of colours are shown in both melamine (D/Exx) and laminate (Lxx).
- W3/W4 shelves in L1000 mm will be delivered in laminat.

DESIGN OPTIONS

WOODEN COMPONENTS - PAINTED

A PRICE GROUP - BASIS PRICE

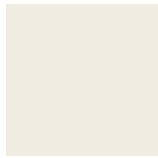

A01
Pure white
RAL 9010
Gloss 20-30



A02
Oyster white
RAL 1013
Gloss 20-30

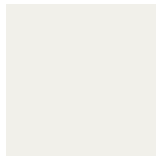

A03
Traffic white
RAL 9016
Gloss 20-30



A04
Traffic yellow
RAL 1023
Gloss 20-30



A05
Sun yellow
RAL 1037
Gloss 20-30



A06
Signal orange
RAL 2010
Gloss 20-30



A07
Pearl orange
RAL 2013
Gloss 20-30



A08
Flame red
RAL 3000
Gloss 20-30



A09
Ruby red
RAL 3003
Gloss 20-30



A21
Reseda green
RAL 6011
Gloss 20-30



A22
Moss green
RAL 6005
Gloss 20-30



A26
Fir green
RAL 6009
Gloss 20-30



A10
Pigeon blue
RAL 5014
Gloss 20-30



A11
Ocean blue
RAL 5020
Gloss 20-30



A12
Steel blue
RAL 5011
Gloss 20-30



A13
Light grey
RAL 7035
Gloss 20-30



A14
White aluminium
RAL 9006
Gloss 20-30



A31
Grey aluminium
RAL 9007
Gloss 20-30



A15
Dusty grey
RAL 7037
Gloss 20-30



A16
Traffic grey
RAL 7043
Gloss 20-30



A17
Basalt grey
RAL 7012
Gloss 20-30



A18
Slate grey
RAL 7015
Gloss 20-30



A19
Anthracite grey
RAL 7016
Gloss 20-30



A25
Jet black
RAL 9005
Gloss 20-30

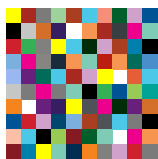

Any RAL/NCS colour
Gloss 20-30

Note:

- The above selection of colours match our steel colours. Note that you can order any RAL/NCS colour without surcharge.
- A surcharge for colours with "metallic" look or different surface textures must be expected, please contact Customer Service.

DESIGN OPTIONS

WOODEN COMPONENTS - VENEER

A PRICE GROUP - BASIS PRICE



55
Light steamed
beech



66
Oak



67
Maple



68
Ash



69
Birch

Note:

- The wooden veneers can also be stained for a surcharge, please contact Customer Service. Samples will be forwarded for approval.

TECHNICAL SPECIFICATIONS

GENERAL SPECIFICATIONS

DIMENSIONS

Dimensions of complete bays in available modules and heights can be found in each catalogue section which include complete configurations. Dimensions of each component can be found under the individual products. All cited measurements are nominal sizes.

MAXIMUM LOAD

The shelving is only intended for use on a flat, even floor without gradient. Before loading the shelving, make sure that the floor is suitable for the weight of the shelving and the stored goods.

The maximum values specified below must be observed.

Maximum area load for Lingo single-sided bay: 480 kg

Maximum area load for Lingo double-sided bay: 960 kg

Maximum area load for Lingo double-sided bay on castor frame with visible/hidden castors: 400 kg

Maximum area load for Lingo double-sided bay on castor plate: 200 kg

Maximum area load for Lingo Square: 600 kg

S1 - Steel shelf with H47 mm steel backedge: 80 kg

S2 - Steel shelf with H17 mm acrylic backedge: 80 kg

S3 - Steel shelf with H25 mm steel backedge: 80 kg

S4 - Steel shelf: 80 kg

S5 - Inner round steel shelf with H47 mm steel backedge: 80 kg

S5 - Outer round steel shelf with H47 mm steel backedge: 80 kg

S6 - Inner round steel shelf: 80 kg

S6 - Outer round steel shelf: 80 kg

ST1 - Steel top shelf: 25 kg

ST2 - Steel top shelf: 80 kg

ST3 - Steel top shelf: 80 kg

S4 - Steel shelf: 80 kg

ST5 - Inner single-sided round steel top shelf H25/47 mm front edge: 25 kg

ST5 - Outer single-sided round steel top shelf H25/47 mm front edge: 25 kg

W1 - Wooden shelf with H47 mm steel backedge: 80 kg

W2 - Wooden shelf: 80 kg

W3 - Wooden shelf with H47 mm steel backedge: 60 kg

W4 - Wooden shelf: 60 kg

W5 - Inner round wooden shelf with H47 mm steel backedge: 80 kg

W5 - Outer round wooden shelf with H47 mm steel backedge: 80 kg

W6 - Inner round wooden shelf: 80 kg

W6 - Outer round wooden shelf: 80 kg

W7 - Inner round wooden shelf with H47 mm steel backedge: 60 kg

W7 - Outer round wooden shelf with H47 mm steel backedge: 60 kg

W8 - Inner round wooden shelf: 60 kg

W8 - Outer round wooden shelf: 60 kg

WT1 - Wooden top shelf: 25 kg

WT3 - Wooden top shelf: 25 kg

WT5 - Inner round wooden top shelf: 25 kg

WT5 - Outer round wooden top shelf: 25 kg

WT7 - Inner round wooden top shelf: 25 kg

WT7 - Outer round wooden top shelf: 25 kg

WO1 - Wooden overlaying top plate: 25 kg

WO5 - Round wooden overlaying top plate: 25 kg

Steel browser with pull-out frame: 40 kg

TECHNICAL SPECIFICATIONS

GENERAL SPECIFICATIONS

BAYS WITH ADJUSTABLE FEET AND TOP SHELVES

They are available as freestanding and intermediate bays.

BAYS WITH ADJUSTABLE FEET AND OVERLAYING TOP PLATES

They are available as starter, intermediate and end sections. You can combine 18°, 26° and straight bays to create the desired complete shelving. For maximum number of combined straight and curved bays that can be constructed in a continuous shelving system, see page xx. The adjustable feet can be adjusted even when the bays are loaded.

BAYS WITH CASTORS

Castors may only be fitted with double-sided bays which do not exceed a maximum height of 1520 mm and a maximum of 3 adjoining bays. Bays on castors are not to be used for transportation. The castors are only fitted in order to move the shelving system around, see instruction below. Crossing doorsteps can be dangerous. After moving the shelving you must lock the brakes. Shelving systems generally have to be moved and placed on a flat, level and horizontal floor.

There is a risk of getting hurt if the shelving system is moved incorrectly. Therefore, the following rules of conduct must be followed:

- It must be ensured that no items can fall off the shelves while moving. If in doubt, then remove items before moving.
- Use a maximum of two people to move the shelving system.
- Make sure to move the shelving system in a smooth movement, avoid jerky movements.
- Only move the shelving system at the ends, do not stand at the long sides of the shelving system during the move.
- To avoid injuries, you must ensure that you always have enough space to the surrounding walls and other furniture.
- If more than one person is involved, be sure to coordinate direction and intention, before actually moving the shelving system.
- Ensure that you only move the shelving system on a flat, level floor with no incline. The floor must be free of any items. Even small parts may cause a sudden blockage of a castor. In this case, the shelving system could tip or damage the floor.
- Before moving, unlock the wheel brakes.
- After moving, lock the wheel brakes.

WEIGHT ON BAYS WITH CASTORS

Visible castors on castor frame are available with and without brakes. We recommend installing at least 2 castors with brakes for one or more adjoining bays. Max. load of 100 kg per visible castor/400 kg per bay.

Hidden castors on castor frame are delivered without brakes, so when shelving is positioned in place, you must adjust the adjustable feet. Max. load of 100 kg per hidden castor/400 kg per bay.

Bays with castor plates are mounted with either 4, 6 or 8 castors, 2 of which are with brakes. Max. load of 200 kg per bay.

BAYS WITH SHELVES

Bays with back panel/back frame: Each bay must have at least 2 shelves (4 shelves for double-sided bays) - top and bottom - screwed into the panels for stability. The remaining shelves can be inserted without screws.

Bays with cross brace: Each bay above H1220 mm must have at least 3 shelves (6 shelves for double-sided bays) - top, middle and bottom - screwed into the panels for stability.

STABILITY

End panels are provided with adjustable feet, except for panels intended for use with castor plates. Single-sided panels are supplied with wall securement and must be fixed to the wall.

ROUNDED EDGES

All storage units and brackets have rounded edges.

TECHNICAL SPECIFICATIONS

GENERAL SPECIFICATIONS

DENSITY

Particle board has a density of 600-700 kg/m³

Block board has a density of 602 kg/m³ (+/- 2 %)

MDF has a density of 700 kg/m³ (+/- 5-7 %)

BROWSERS

Shelvings can be fitted with browsers. Pulling out one or more browsers could cause the shelving to tip. Ensure that the shelving cannot tip by securing shelving. If in doubt, you must fix the shelving to the floor, wall or ceiling.

For safety reasons:

- It is not allowed to load browsers with more than 45 kg.
- Do not use the browsers as a step. The lowest browser must be installed at least 50 cm above the ground. This should ensure that the browser is not used as a step.
- Single-sided bays must be fixed to the wall. A maximum of 3 drawers per bay is allowed.
- Only 1 browser per side and bay is allowed on double-sided bays.
- Do not install pull-out browsers on shelving with castors.

ASSEMBLY

All wooden shelving units come knocked-down. Assembly guidelines can be found on our website.

TECHNICAL SPECIFICATIONS

GENERAL SPECIFICATIONS

BACK FRAME

Straight configurations with steel back frame include the necessary frames depending on height and number of bays. This is to ensure stability. When you order the products as components please note the following:

Single-sided bays

All heights: order one back frame per bay

Double-sided bays

H720/920/1220/H1520: order one back frame per bay

H1820/2120 mm: order based on overview below

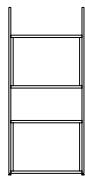

1 double-sided bay
=
2 back frames

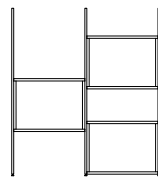

2 double-sided bays
=
3 back frames

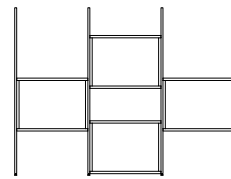

3 double-sided bays
=
4 back frames

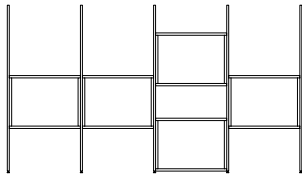

4 double-sided bays
=
5 back frames

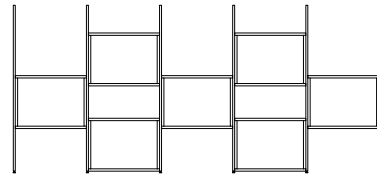

5 double-sided bays
=
7 back frames

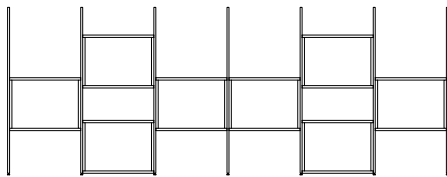

6 double-sided bays
=
8 back frames

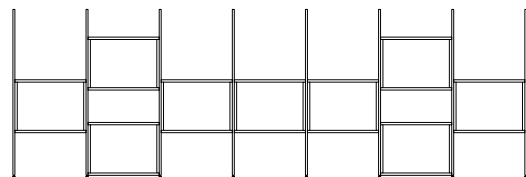

7 double-sided bays
=
9 back frames

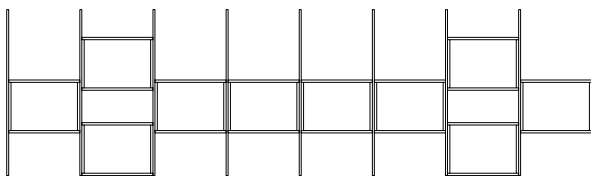

8 double-sided bays
=
10 back frames

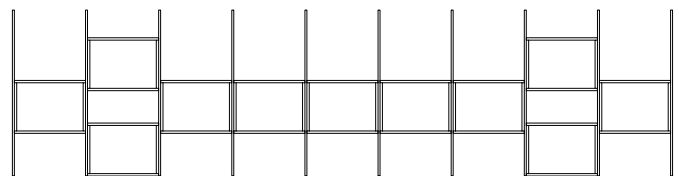

9 double-sided bays
=
11 back frames

TECHNICAL SPECIFICATIONS

STEEL COMPONENTS

STEEL COMPONENTS

are powder coated with standard polyester based powders that secures high UV resistance. Powders comply with EN 45545 (fire protection - similar to DIN 4201). Thickness of the coating is 60-80 μ m.

The powder used includes:

- no azo dyes that can release a leaving carcinogenic amine component
- no triglycidylisocyanurate (TGIC)
- no heavy steel-containing pigments such as lead and cadmium
- no volatiles

Antibacterial equipping of surfaces upon request.

BACK FRAMES

are made of 30 x 20 x 1.5 mm steel tubes. The back frame is easy to assemble between the panels.

CROSS BRACES

are made of galvanized steel \varnothing 4 mm.

BACK PANELS

are made of 0,9 mm steel.

SHELVES AND BROWSERS

are made of 0.9 mm sheet steel. The steel shelves have a H25 mm frontedge, the steel top shelves have a H25/47 mm frontedge.

BRACKETS

are made of 1.4 mm sheet steel.

FRAMES FOR CASTORS

are made of:

visible castors: 40 x 30 x 2 steel tubes. The end plates are made of 2 mm sheet steel.

hidden castors: 30 x 30 x 2. steel tubes. The end plates are made of 2 mm sheet steel, the plinth is made of 0,9 mm sheet steel.

STRAIGHT PLINTHS

are made of 1,4 mm steel.

ROUND PLINTHS

are made of 0,9 mm steel.

TECHNICAL SPECIFICATIONS

WOODEN MELAMINE COMPONENTS

WOODEN MELAMINE COMPONENTS

are made of particle board/block board.

PANELS

are made of 25 mm particle board with a 2 mm ABS border. The panels have two holes in the bottom for adjustable feet except from double-sided intermediate panels above 1220 mm, they have 4 holes for adjustable feet.

END PANELS FOR LINGO SQUARE

are made of 25 mm particle board 2 mm ABS border.

BACK PANELS

are made of 19 mm particle board with a 2 mm ABS border on the horizontal edges.

SHELVES

W3 and W4 (modules 500/750/900) are made of 25 mm particle board with a 2 mm ABS border.

W3 and W4 (module 1000) are made of 25 mm block board and has a laminate finish, except for colour D62, which has a melamin finish.

W7 and W8 are made of 25 mm particle board.

WT3 and WT7 are made of 25 mm particle board with a 2 mm ABS border.

WO1 and WO5 are made of 25 mm particle board with a 2 mm ABS border.

CASTOR PLATES

are made of 25 mm particle board with a 2 mm ABS border.

PLINTHS

are made of 25 mm particle board with a 2 mm ABS border on the horizontal edges.

TECHNICAL SPECIFICATIONS

WOODEN PAINTED COMPONENTS

WOODEN PAINTED COMPONENTS

are made of either particle board (with a paintable foil)/MDF/MDF blockboard, which are painted with acid lacquer. Standard components have gloss 20 - 30. See Design Options for colour specifications.

PANELS

are made of 25 mm particle board or MDF, with a 2 mm paintable ABS border. The panels have two holes in the bottom for adjustable feet, double-sided intermediate panels above 1220 mm have 4 holes for adjustable feet.

DISPLAY END PANELS

are made of 25 mm MDF with a 2 mm paintable ABS border. The panels have two holes in the bottom for adjustable feet.

END PANELS FOR LINGO SQUARE

are made of 25 mm MDF.

BACK PANELS

are made of 19 mm MDF and are painted on all sides and edges.

SHELVES

W1 and W2 are made of 25 mm MDF block board.

W5 and W6 are made of 25 mm MDF block board.

WT1 and WT5 are made of 25 mm particle board or MDF, with a 2 mm paintable ABS border.

WO1 and WO5 are made of 25 mm particle board or MDF, with a 2 mm paintable ABS border.

CASTOR PLATES

are made of 25 mm particle board or MDF with a 2 mm paintable ABS border.

PLINTHS

are made of 25 mm particle board or MDF with a 2 mm paintable ABS border on the horizontal edges.

TECHNICAL SPECIFICATIONS

WOODEN VENEERED COMPONENTS

WOODEN VENEERED COMPONENTS

are mainly lacquered with a environmental-friendly UV transparent lacquered veneer finish.

PANELS

are made of 25 mm particle board and are veneered with 0.6 mm veneer. All edges on the panels have a 2 mm veneer edge. The panels have two holes in the bottom for adjustable feet except from double-sided intermediate panels above 1220 mm, they have 4 holes for adjustable feet.

DISPLAY END PANELS

are made of 25 mm MDF and are veneered with 0.6 mm veneer. All edges have a 2 mm veneer edge. The panels have two holes in the bottom for adjustable feet.

END PANELS FOR LINGO SQUARE

are made of 25 mm particle board and are veneered with 0.6 mm veneer. All edges have a 2 mm veneer edge.

BACK PANELS

are made of 19 mm particle board and are veneered with 0.6 mm veneer. The horizontal edges have a 2 mm veneer edge. The vertical edges are not banded, as they are not exposed after assembly of the back panel.

SHELVES

W1 and W2 are made of 25 mm block board and are veneered with 0.6 mm veneer. The front and back edges have a 2 mm veneer edge.

W5 and W6 are made of 25 mm block board and are veneered with 0.6 mm veneer. The front and back edges have a 2 mm veneer edge.

WT1 and WT5 are made of 25 mm particle board and are veneered with 0.6 mm veneer. The front and back edges have a 2 mm veneer edge.

WO1 and WO5 are made of 25 mm particle board and are veneered with 0.6 mm veneer. All edges on the panels have a 2 mm veneer edge.

CASTOR PLATES

are made of 25 mm particle board and are veneered with 0.6 mm veneer. All edges on the castor plate have a 2 mm veneer edge.

PLINTHS

are made of 25 mm particleboard and are veneered with 0.6 mm veneer on the front. The top and bottom edge have a 2 mm veneer edge.

DIMENSIONS

LINGO SHELVING



The distance between the front edge of the end panel and the front edge of the shelf is 7 mm. The shelves are adjustable in 25 mm increments.

Lingo shelving configurations are delivered as standard based on price group A (melamine coated/painted/veneer), see p. 6-9 for Design Options.

HEIGHTS

Lingo shelving is available in 6 heights; 720, 920, 1220, 1520, 1820 and 2120 mm. Heights shown below are for shelving with adjustable feet/castor frame/castor plate.

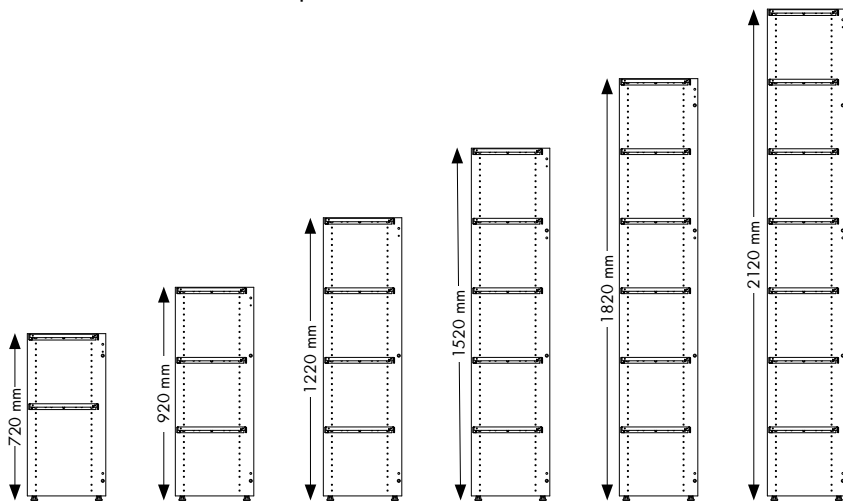

WIDTHS

Lingo shelving is available in 4 widths: 500, 750, 900 and 1000 mm.

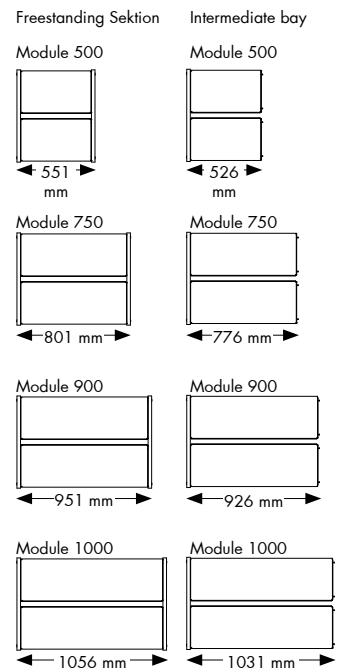

DEPTHS

Lingo shelving is available in 2 x 3 depths: 250, 300 and 400 mm. 2 x 250, 2 x 300 and 2 x 400 mm

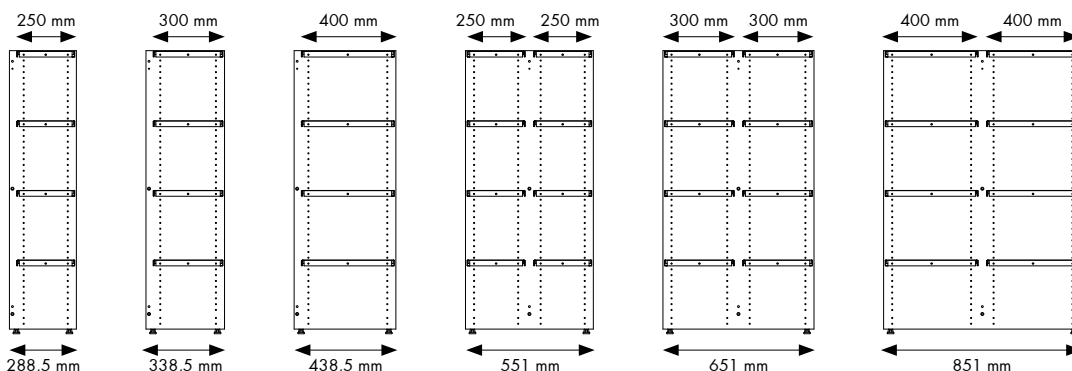

DIMENSIONS

LINGO SQUARE



The distance between the front edge of the end panel and the front edge of the shelf is 7 mm. The shelves are adjustable in 25 mm increments.

Lingo Square configurations are delivered as standard based on price group A (melamine coated/painted/veneer), see p. 6-9 for Design Options.

HEIGHTS

Lingo Square is available in 4 heights: 920, 1220, 1520 and 1820 mm.

Heights shown below are for shelving with adjustable feet/castors.

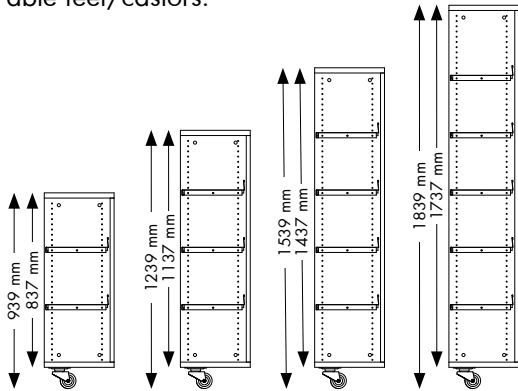

WIDTHS

Lingo Square is available in 3 widths: 500, 750 and 900 mm.

Module 500

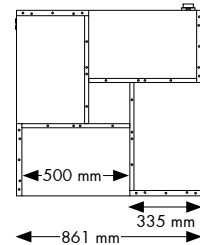
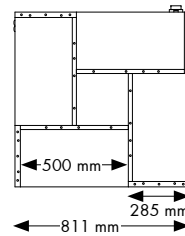

Module 750

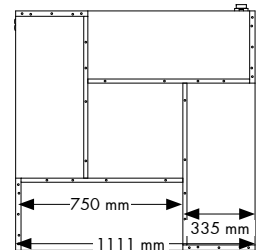
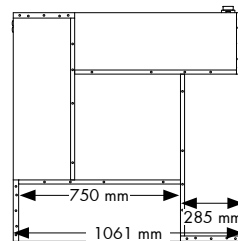

Module 900

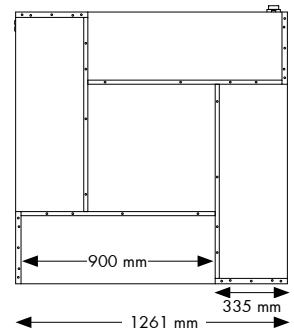
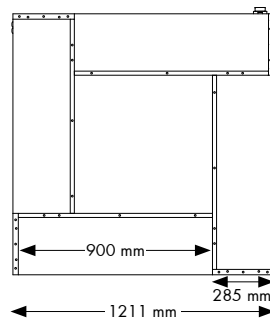

DEPTHS

Lingo Square is available in 2 depths; 250 and 300 mm

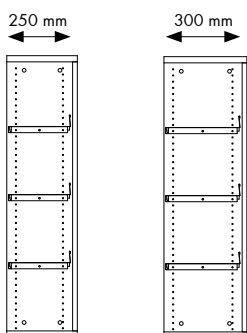

DIMENSIONS

LINGO ROUND SHELVING

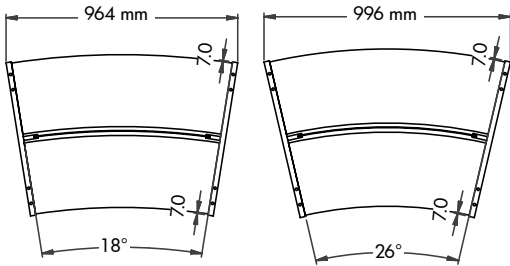

The distance between the front edge of the end panel and the front edge of the shelf is 7 mm. The shelves are adjustable in 25 mm increments.

Lingo Round configurations are delivered as standard based on price group A (melamine coated/painted/veneer), see p. 6-9 for Design Options.

HEIGHTS

Lingo Round shelving is available in 6 heights; 720, 920, 1220, 1520, 1820 and 2120 mm. Heights shown below are for shelving with adjustable feet/castor frame/castor plate.

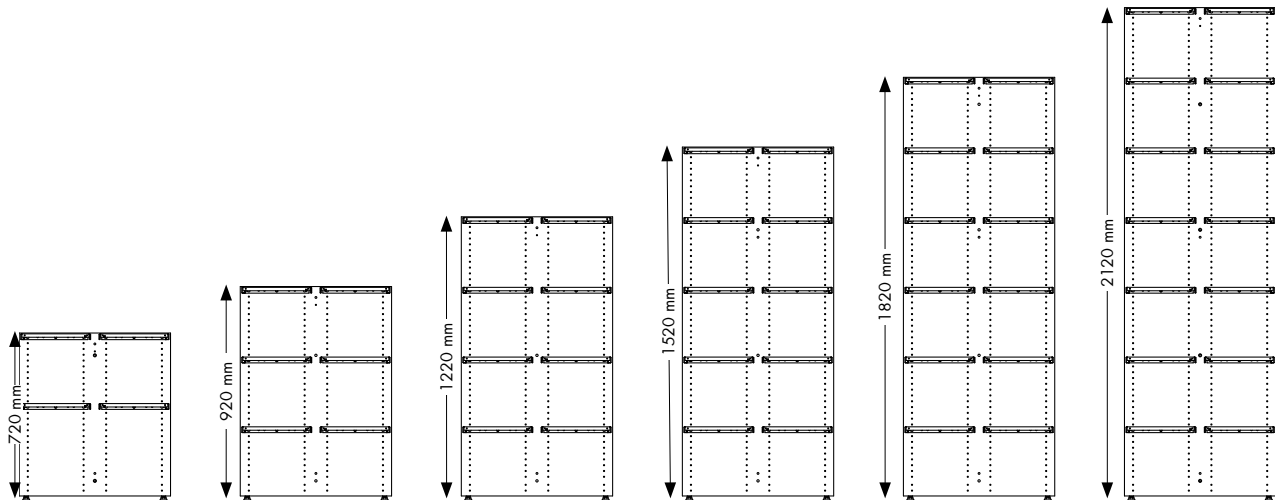

DEPTHS

Lingo Round shelving is available in 1 depth: 2 x 300 mm. 651 mm.

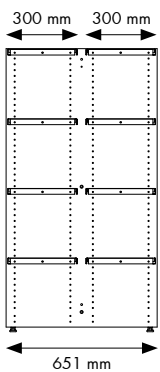

DIMENSIONS

LINGO ROUND SHELVING

LINGO ROUND 26°

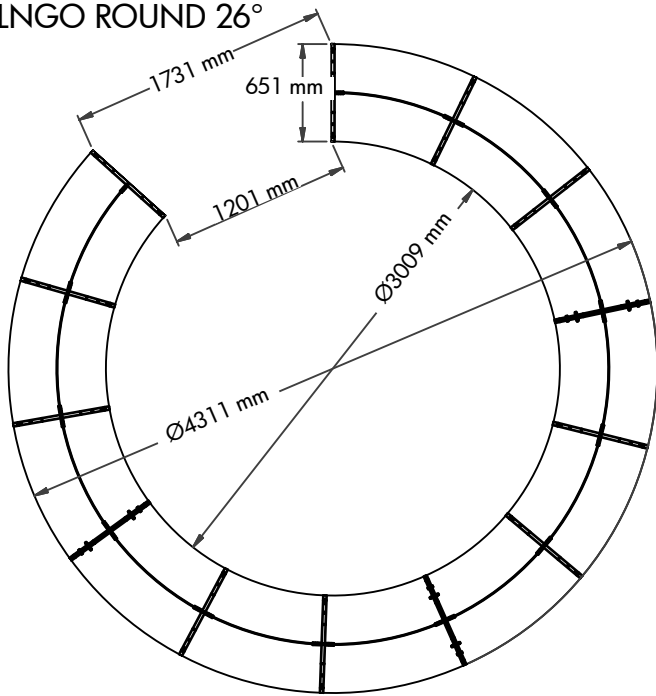

LINGO ROUND 18°

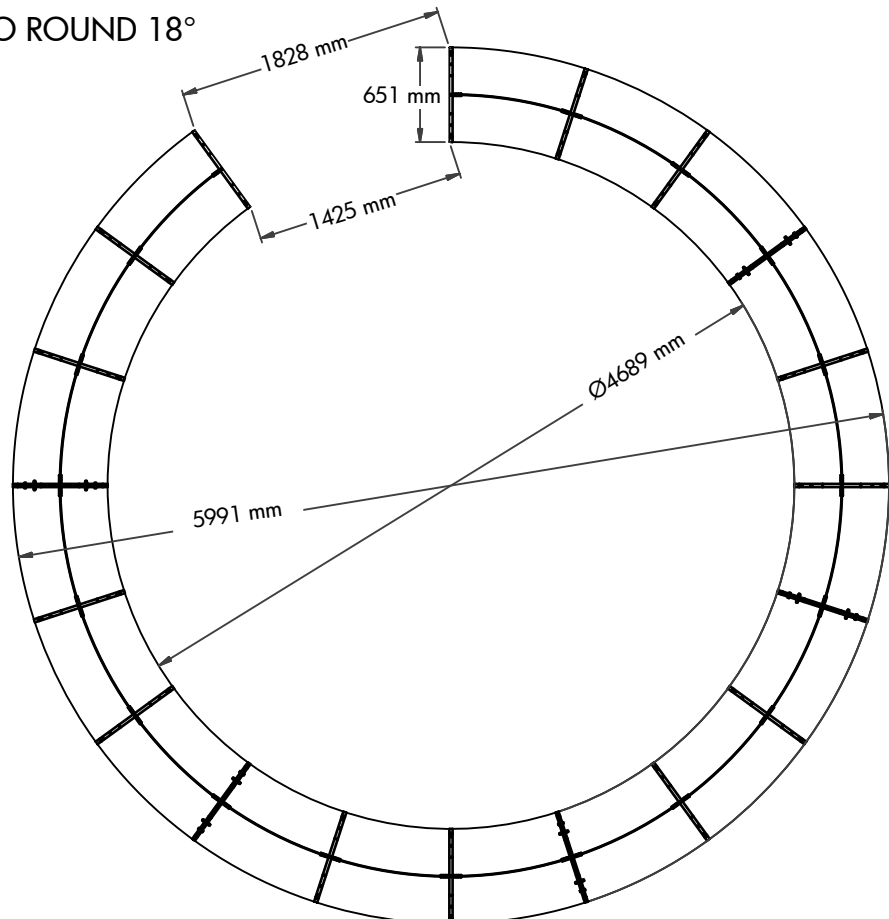

BAY CONSTRUCTION

FREESTANDING AND INTERMEDIATE BAYS BBN001/BBN201/BBN221

A freestanding bay includes one right and one left end panel with holes on the inside of the panel. To add another bay, you must take off the right end panel, insert the intermediate bay (panel with holes on both sides) and fix the right end panel from the freestanding bay to the intermediate bay. See example below and configuration no. 5 on page 29.

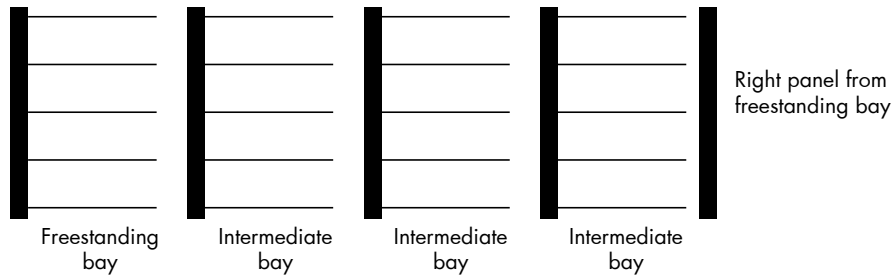

OVERLAYING TOP PLATES FOR STRAIGHT BAYS WITH ADJUSTABLE FEET

A straight overlaying top plate has a maximum length of 2750 mm.

If you build a shelving system with 1, 2 or 3 bays, then you can use just one freestanding top plate (depending on module size).

If you build a shelving system with more than 3 bays, then the overlaying top plates will be a combination of outer and intermediate overlaying top plates.

Freestanding wooden top plate

Is always used for 1 bay and can be used for 1, 2 or 3 bays. The top plate covers the end panels in both ends.

Total width mm				
Module	500	750	900	1000
1 bay	551	801	951	1056
2 bays	1078	1578	1878	2088
3 bays	1604	2354	-	-

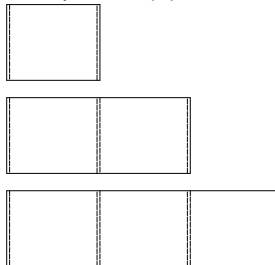

Outer wooden top plate

Can be used for 1, 2 or 3 bays in combination with either outer or intermediate top plates. The top plate covers one end panel.

Total width mm				
Module	500	750	900	1000
1 bay	539	789	939	1044
2 bays	1065	1565	1865	2075
3 bays	1592	2342	-	-

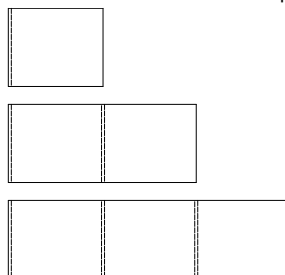

Intermediate wooden top plate

Can be used for 1, 2 or 3 bays in combination with either outer or intermediate top plates. The top plate only covers the intermediate panel.

Total width mm				
Module	500	750	900	1000
1 bay	526	776	926	1031
2 bays	1053	1553	1853	2063
3 bays	1829	2329	-	-

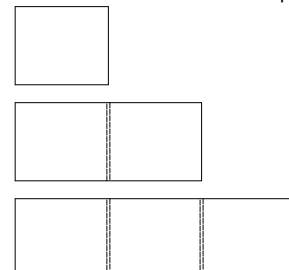

BAY CONSTRUCTION

OVERLAYING TOP PLATES FOR ROUND BAYS WITH ADJUSTABLE FEET

If you build a shelving system with 1, 2 or 3 bays, then you can use just one freestanding top plate.

If you build a shelving system with more than 3 bays, then the overlaying top plates will be a combination of outer and intermediate overlaying top plates.

Freestanding wooden top plate

Is always used for 1 bay and can be used for 1, 2 or 3 bays. The top plate covers the end panels in both ends.

Dimensions mm				
Bay	26°x	26°y	18°x	18°y
1 bay	994	692	962	682
2 bays	1912	809	1875	770
3 bays	2732	994	2742	912

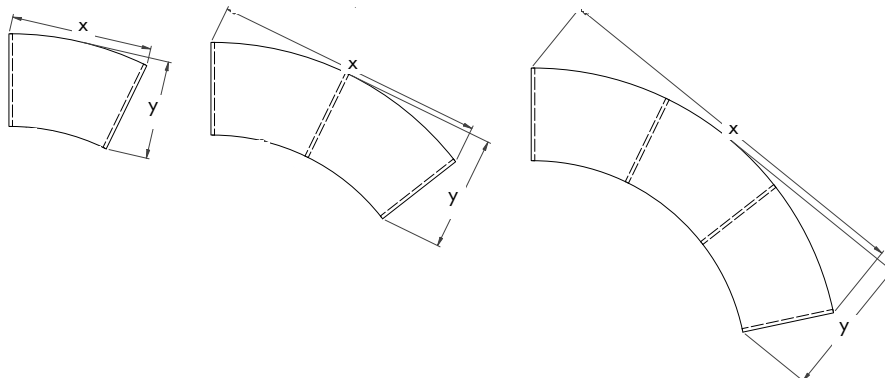

Left/right starter/end wooden top plate

Can be used for 1, 2 or 3 bays in combination with either outer or intermediate top plates. The top plate covers one end panel.

Dimensions mm				
Bay	26°x	26°y	18°x	18°y
1 bay	982	691	951	682
2 bays	1901	806	1861	770
3 bays	2723	990	2731	912

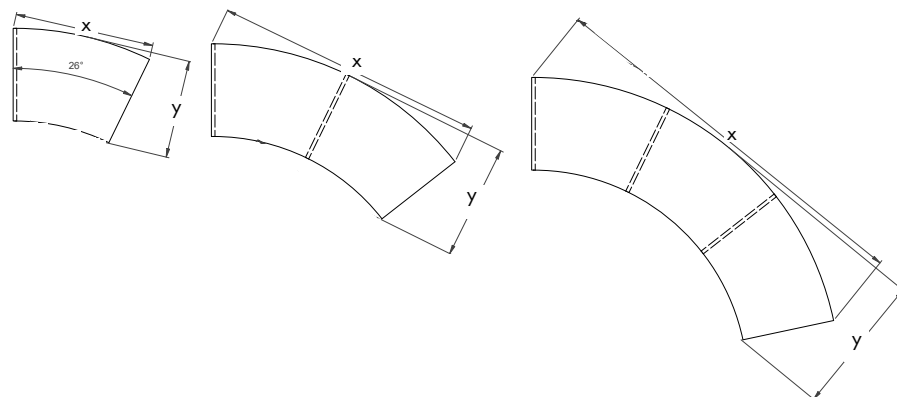

Intermediate wooden top plate

Can be used for 1, 2 or 3 bays in combination with either outer or intermediate top plates. The top plate only covers the intermediate panel.

Dimensions mm				
Bay	26°x	26°y	18°x	18°y
1 bay	982	691	940	677
2 bays	1901	806	1853	765
3 bays	2723	990	2720	907

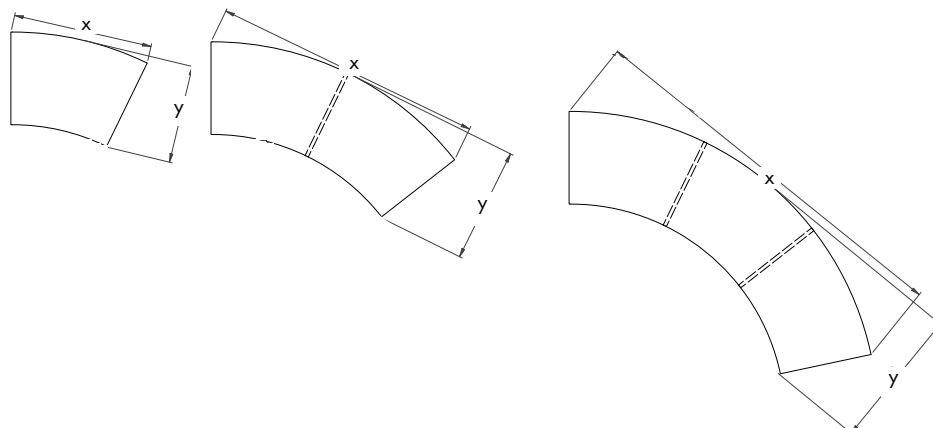

BAY CONSTRUCTION

LEFT/RIGHT STARTER/END ROUND SECTIONS

When constructing a round Lingo shelving system with adjustable feet and top plate (BBN202/BBN222), you must look at the shelving from the inside of the curve to determine which section is needed in the complete shelving system. This means that you will have to change position to find the correct sections to design your final shelving system.

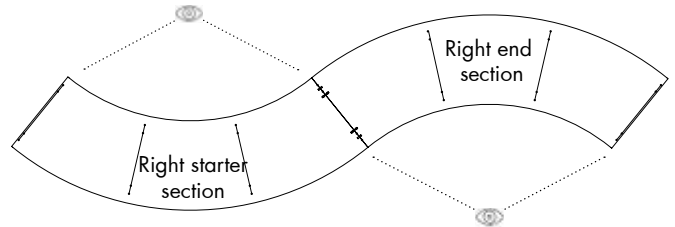
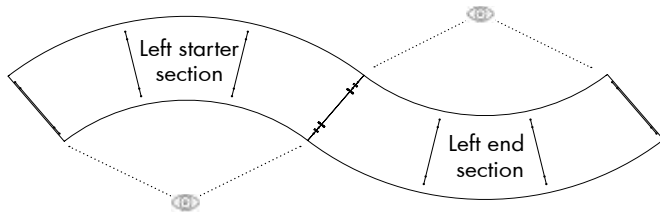

LEFT STARTER SECTION

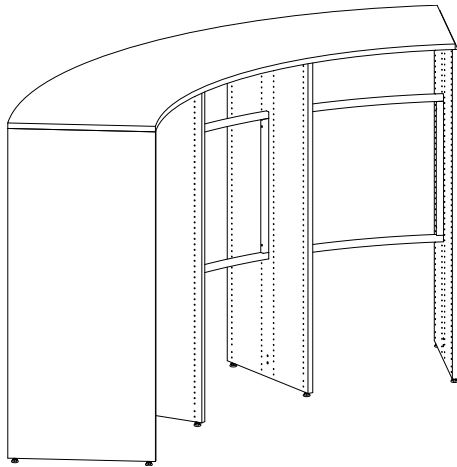

The left starter section starts with a left end panel and ends with an intermediate panel.

RIGHT STARTER SECTION

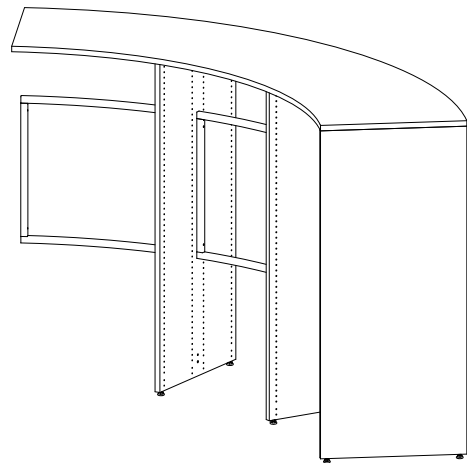

The right starter section starts with a right end panel and ends with an intermediate panel.

LEFT END SECTION

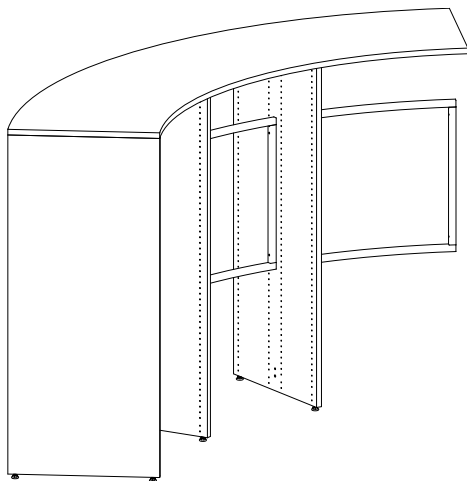

The left end section starts without an intermediate panel and ends with a left end panel.

RIGHT END SECTION

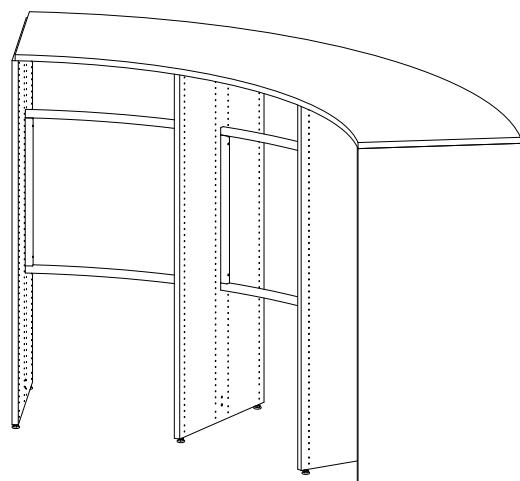

The right end section starts without an intermediate panel and ends with a right end panel.

BAY CONSTRUCTION

INTERMEDIATE SECTIONS

When constructing a round Lingo shelving system with adjustable feet and top plate (BBN202/BBN222) over more than 3 bays, it will be necessary to have an intermediate section in between the starter and end sections.

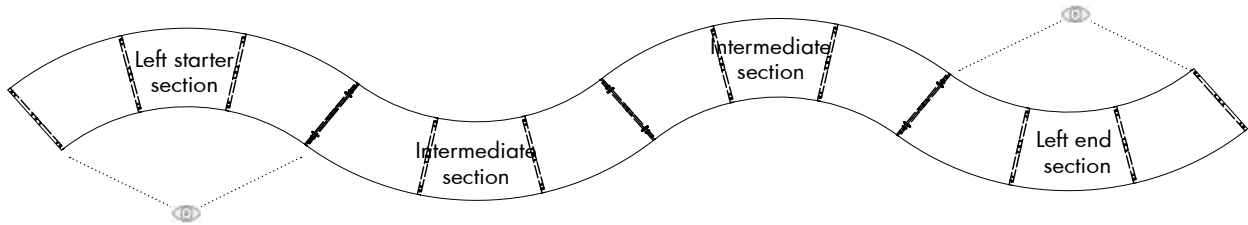

INTERMEDIATE SECTION

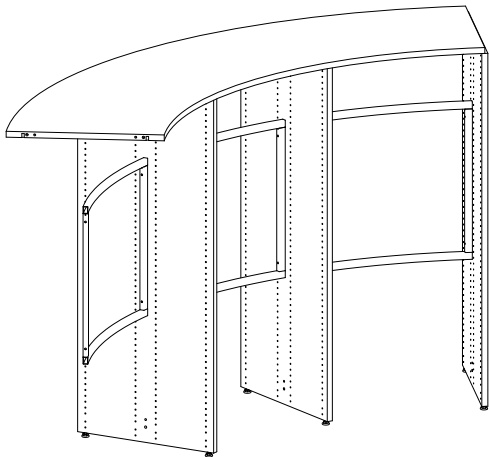

An intermediate section starts without an intermediate panel and ends with an intermediate panel.

STRAIGHT AND ROUND COMBINATIONS

COMBINING STRAIGHT AND ROUND SHELVING

It is possible to combine round and straight shelving to create unique shelving - all depending on space available on location, shelving space required and design.

BAYS ON ADJUSTABLE FEET

There are restrictions to be considered when constructing round shelving, due to the angle of the complete number of bays. The overview shows the maximum number of bays that can be constructed in a continuous shelving system, before you must change the angle/direction of the shelving.

	Number of adjoining bays possible in freestanding section	Number of adjoining bays possible in left/right starter section	Number of adjoining bays possible in intermediate section	Number of adjoining bays possible in left/right end section
26°	Up to 12 bays	Total of 9 bays	7 bays	Total of 9 bays
18°	Up to 18 bays	Total of 13 bays	10 bays	Total of 13 bays
Straight	Up to 9 bays	Total of 9 bays	9 bays	Total of 9 bays

BAYS ON CASTOR PLATE

The overview above also applies to bays on castor plates, however castor plates are constructed in a maximum of 3 bays and not in a continuous shelving system.

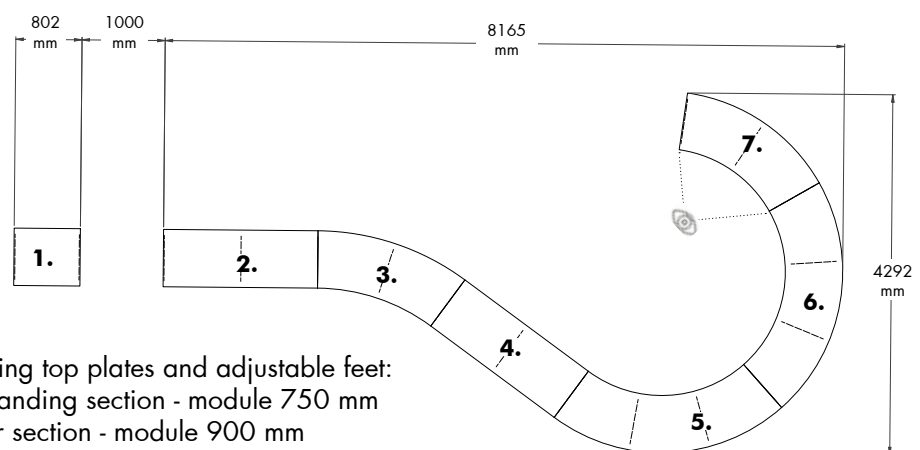

CONFIGURATION NO. 1

Consists of 15 bays with 7 overlaying top plates and adjustable feet:

- 1: BBN002 - 1 bay - straight freestanding section - module 750 mm
- 2: BBN002 - 2 bays - straight outer section - module 900 mm
- 3: BBN222 - 2 bays - 18° intermediate section
- 4: BBN002 - 2 bays - straight intermediate section - module 900 mm
- 5: BBN202 - 3 bays - 26° intermediate section
- 6: BBN202 - 3 bays - 26° intermediate section
- 7: BBN202 - 2 bays - 26° left end section

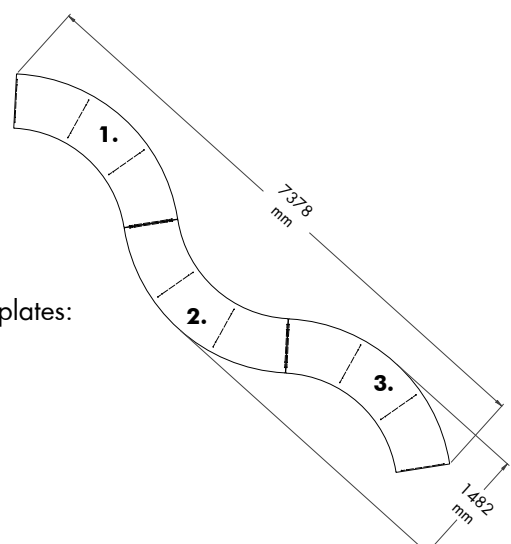

CONFIGURATION NO. 2

Consists of 9 bays with 3 overlaying top plates and 3 castor plates:

- 1: BBN212 - 3 bays - 26° freestanding section
- 2: BBN212 - 3 bays - 26° freestanding section
- 3: BBN212 - 3 bays - 26° freestanding section

STRAIGHT AND ROUND COMBINATIONS

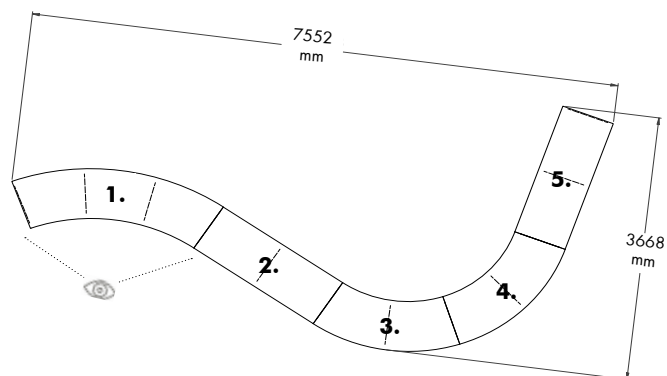

CONFIGURATION NO. 3

Consists of 11 bays with 5 overlaying top plates and adjustable feet:

- 1: BBN222 - 3 bays - 18° left starter section
- 2: BBN002 - 2 bays - straight intermediate section - module 900 mm
- 3: BBN202 - 2 bays - 26° intermediate section
- 4: BBN202 - 2 bays - 26° intermediate section
- 5: BBN002 - 2 bays - straight outer section - module 900 mm

CONFIGURATION NO. 4

Consists of 15 bays with 5 overlaying top plates and 5 castor plates:

- 1: BBN232 - 3 bays - 18° freestanding section
- 2: BBN232 - 3 bays - 18° freestanding section
- 3: BBN232 - 3 bays - 18° freestanding section
- 4: BBN232 - 3 bays - 18° freestanding section
- 5: BBN232 - 3 bays - 18° freestanding section

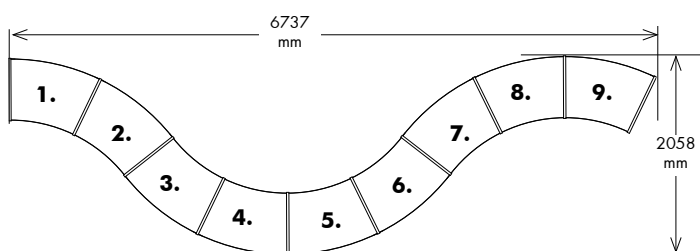
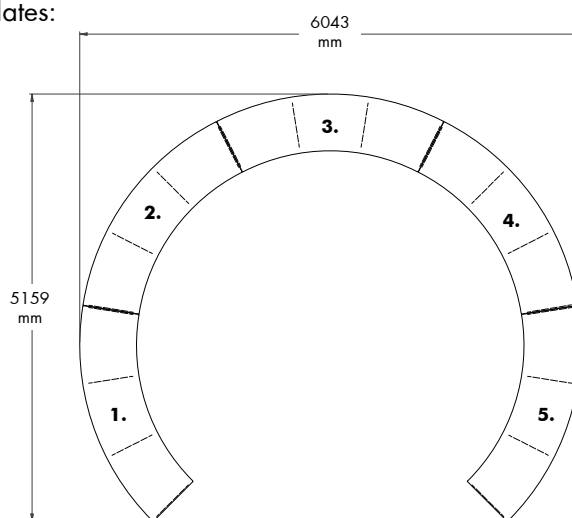

CONFIGURATION NO. 5

Consists of 9 bays with wooden top shelves and adjustable feet:

- 1: BBN201 - 1 bay - 26° freestanding
- 2-9: BBN201 - 8 bays - 26° intermediate

LINGO SHELVING SYSTEM

BBN001 - STEEL BACK FRAME - ADJUSTABLE FEET - FOR TOP SHELF



LINGO SHELVING SYSTEM

BBN001 - STEEL BACK FRAME - ADJUSTABLE FEET - FOR TOP SHELF

Shelving system with wooden panels and steel back frame. To be used with top shelf.
Freestanding bay includes 2 outer panels and 1 or 2 steel back frame depending on height.
Intermediate bay includes 1 intermediate panel and 1 steel back frame.

- Prices based on steel price group 1 and wooden price group A (see Design Options pages 6-9).
- For top shelves, see pages 156 & 174
- For shelves see page 144 & 166.
- For accessories see page 186.

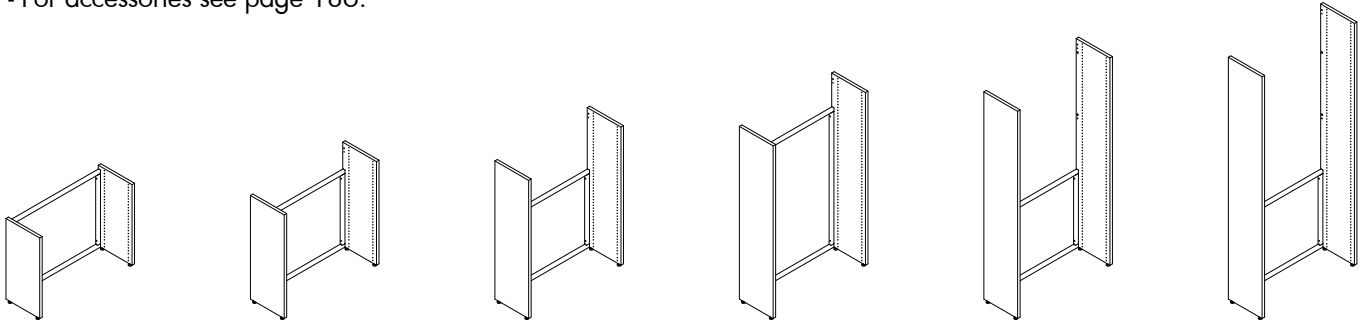

Single-sided freestanding bay - H720/920/1220/1520/1820/2120 mm

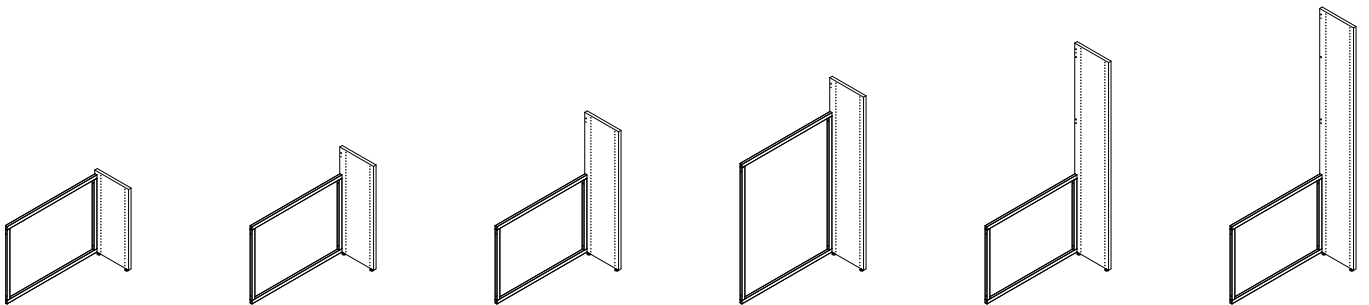

Single-sided intermediate bay - H720/920/1220/1520/1820/2120 mm

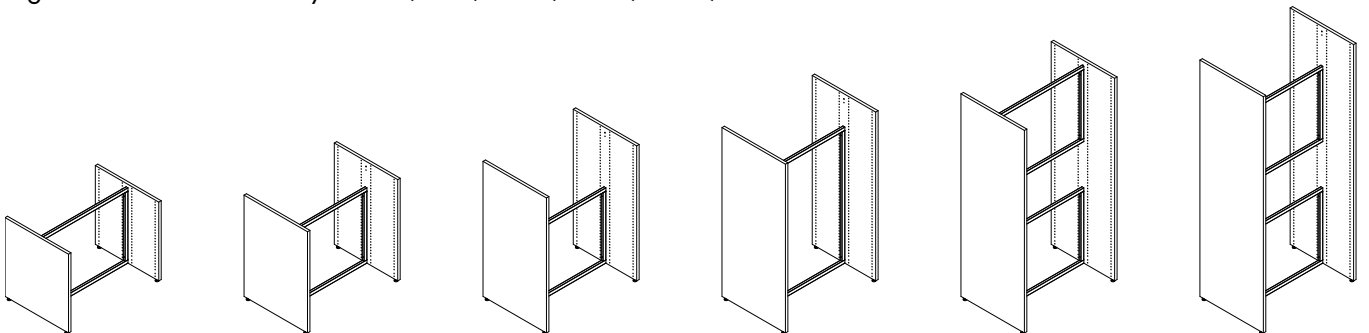

Double-sided freestanding bay - H720/920/1220/1520/1820/2120 mm

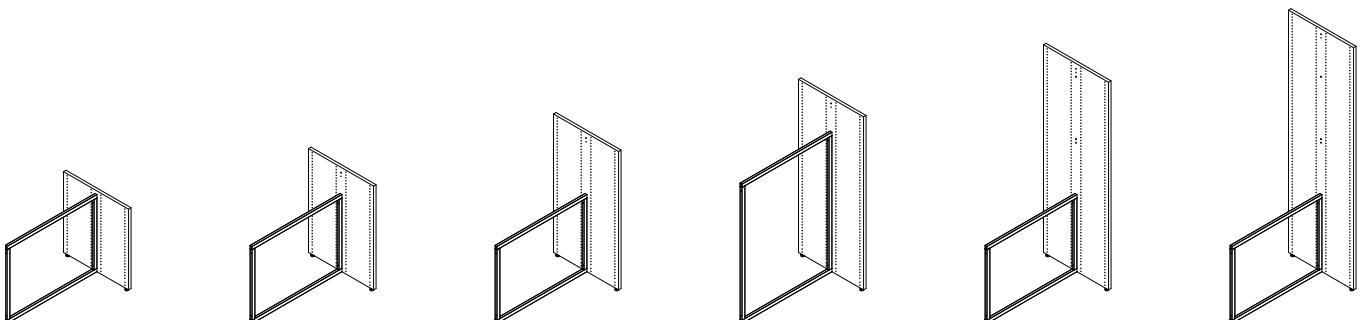

Double-sided intermediate bay - H720/920/1220/1520/1820/2120 mm

LINGO SHELVING SYSTEM

SINGLE-SIDED - STEEL BACK FRAME - ADJUSTABLE FEET - FOR TOP SHELF

Painted and veneered Lingo Shelving Systems are FSC-certified.

H720 mm

Module mm	Shelf depth mm	Item no. Freestanding bay	Melamine EUR	Painted EUR	Veneer EUR	Item no. Intermediate bay	Melamine EUR	Painted EUR	Veneer EUR
500	250	BBN001235510160000.	245,39	274,91	353,11	BBN001235320160000.	162,66	177,42	216,52
500	300	BBN001255510160000.	269,59	302,83	392,49	BBN001255320160000.	174,76	191,38	236,21
500	400	BBN001275510160000.	336,89	382,37	503,41	BBN001275320160000.	208,41	231,15	291,67
750	250	BBN001237510160000.	245,39	274,91	353,11	BBN001237320160000.	162,66	177,42	216,52
750	300	BBN001257510160000.	269,59	302,83	392,49	BBN001257320160000.	174,76	191,38	236,21
750	400	BBN001277510160000.	336,89	382,37	503,41	BBN001277320160000.	208,41	231,15	291,67
900	250	BBN001239510160000.	245,39	274,91	353,11	BBN001239320160000.	162,66	177,42	216,52
900	300	BBN001259510160000.	269,59	302,83	392,49	BBN001259320160000.	174,76	191,38	236,21
900	400	BBN001279510160000.	336,89	382,37	503,41	BBN001279320160000.	208,41	231,15	291,67
1000	250	BBN001231510160000.	256,03	285,55	363,75	BBN001231320160000.	173,30	188,06	227,16
1000	300	BBN001251510160000.	280,23	313,47	403,13	BBN001251320160000.	185,40	202,02	246,85
1000	400	BBN001271510160000.	347,53	393,01	514,05	BBN001271320160000.	219,05	241,79	302,31

H920 mm

Module mm	Shelf depth mm	Item no. Freestanding bay	Melamine EUR	Painted EUR	Veneer EUR	Item no. Intermediate bay	Melamine EUR	Painted EUR	Veneer EUR
500	250	BBN001335510160000.	291,93	329,43	428,65	BBN001335320160000.	185,93	204,68	254,29
500	300	BBN001355510160000.	322,53	365,09	479,73	BBN001355320160000.	201,23	222,51	279,83
500	400	BBN001375510160000.	408,45	466,17	620,97	BBN001375320160000.	244,19	273,05	350,45
750	250	BBN001337510160000.	291,93	329,43	428,65	BBN001337320160000.	185,93	204,68	254,29
750	300	BBN001357510160000.	322,53	365,09	479,73	BBN001357320160000.	201,23	222,51	279,83
750	400	BBN001377510160000.	408,45	466,17	620,97	BBN001377320160000.	244,19	273,05	350,45
900	250	BBN001339510160000.	291,93	329,43	428,65	BBN001339320160000.	185,93	204,68	254,29
900	300	BBN001359510160000.	322,53	365,09	479,73	BBN001359320160000.	201,23	222,51	279,83
900	400	BBN001379510160000.	408,45	466,17	620,97	BBN001379320160000.	244,19	273,05	350,45
1000	250	BBN001331510160000.	302,57	340,07	439,29	BBN001331320160000.	196,57	215,32	264,93
1000	300	BBN001351510160000.	333,17	375,73	490,37	BBN001351320160000.	211,87	233,15	290,47
1000	400	BBN001371510160000.	419,09	476,81	631,61	BBN001371320160000.	254,83	283,69	361,09

H1220 mm

Module mm	Shelf depth mm	Item no. Freestanding bay	Melamine EUR	Painted EUR	Veneer EUR	Item no. Intermediate bay	Melamine EUR	Painted EUR	Veneer EUR
500	250	BBN001435510160000.	360,57	409,77	542,23	BBN001435320160000.	220,25	244,85	311,08
500	300	BBN001455510160000.	372,79	424,41	561,93	BBN001455320160000.	226,36	252,17	320,93
500	400	BBN001475510160000.	504,73	579,75	779,51	BBN001475320160000.	292,33	329,84	429,72
750	250	BBN001437510160000.	360,57	409,77	542,23	BBN001437320160000.	220,25	244,85	311,08
750	300	BBN001457510160000.	372,79	424,41	561,93	BBN001457320160000.	226,36	252,17	320,93
750	400	BBN001477510160000.	504,73	579,75	779,51	BBN001477320160000.	292,33	329,84	429,72
900	250	BBN001439510160000.	360,57	409,77	542,23	BBN001439320160000.	220,25	244,85	311,08
900	300	BBN001459510160000.	372,79	424,41	561,93	BBN001459320160000.	226,36	252,17	320,93
900	400	BBN001479510160000.	504,73	579,75	779,51	BBN001479320160000.	292,33	329,84	429,72
1000	250	BBN001431510160000.	371,21	420,41	552,87	BBN001431320160000.	230,89	255,49	321,72
1000	300	BBN001451510160000.	383,43	435,05	572,57	BBN001451320160000.	237,00	262,81	331,57
1000	400	BBN001471510160000.	515,37	590,39	790,15	BBN001471320160000.	302,97	340,48	440,36

LINGO SHELVING SYSTEM

SINGLE-SIDED - STEEL BACK FRAME - ADJUSTABLE FEET - FOR TOP SHELF

Painted and veneered Lingo Shelving Systems are FSC-certified.

H1520 mm

Module mm	Shelf depth mm	Item no. Freestanding bay	Melamine EUR	Painted EUR	Veneer EUR	Item no. Intermediate bay	Melamine EUR	Painted EUR	Veneer EUR
500	250	BBN001535510160000.	422,81	479,19	629,23	BBN001535320160000.	263,34	291,53	366,55
500	300	BBN001555510160000.	434,77	493,57	648,63	BBN001555320160000.	269,32	298,72	376,25
500	400	BBN001575510160000.	593,57	680,03	909,85	BBN001575320160000.	348,72	391,95	506,86
750	250	BBN001537510160000.	422,81	479,19	629,23	BBN001537320160000.	263,34	291,53	366,55
750	300	BBN001557510160000.	434,77	493,57	648,63	BBN001557320160000.	269,32	298,72	376,25
750	400	BBN001577510160000.	593,57	680,03	909,85	BBN001577320160000.	348,72	391,95	506,86
900	250	BBN001539510160000.	422,81	479,19	629,23	BBN001539320160000.	263,34	291,53	366,55
900	300	BBN001559510160000.	434,77	493,57	648,63	BBN001559320160000.	269,32	298,72	376,25
900	400	BBN001579510160000.	593,57	680,03	909,85	BBN001579320160000.	348,72	391,95	506,86
1000	250	BBN001531510160000.	436,38	492,76	642,80	BBN001531320160000.	276,91	305,10	380,12
1000	300	BBN001551510160000.	448,34	507,14	662,20	BBN001551320160000.	282,89	312,29	389,82
1000	400	BBN001571510160000.	607,14	693,60	923,42	BBN001571320160000.	362,29	405,52	520,43

H1820 mm

Module mm	Shelf depth mm	Item no. Freestanding bay	Melamine EUR	Painted EUR	Veneer EUR	Item no. Intermediate bay	Melamine EUR	Painted EUR	Veneer EUR
500	250	BBN001635510160000.	453,93	519,89	695,99	BBN001635320160000.	266,93	299,91	387,96
500	300	BBN001655510160000.	462,71	530,27	709,81	BBN001655320160000.	271,32	305,10	394,87
500	400	BBN001675510160000.	640,13	739,07	1.003,21	BBN001675320160000.	360,03	409,50	541,57
750	250	BBN001637510160000.	453,93	519,89	695,99	BBN001637320160000.	266,93	299,91	387,96
750	300	BBN001657510160000.	462,71	530,27	709,81	BBN001657320160000.	271,32	305,10	394,87
750	400	BBN001677510160000.	640,13	739,07	1.003,21	BBN001677320160000.	360,03	409,50	541,57
900	250	BBN001639510160000.	453,93	519,89	695,99	BBN001639320160000.	266,93	299,91	387,96
900	300	BBN001659510160000.	462,71	530,27	709,81	BBN001659320160000.	271,32	305,10	394,87
900	400	BBN001679510160000.	640,13	739,07	1.003,21	BBN001679320160000.	360,03	409,50	541,57
1000	250	BBN001631510160000.	464,57	530,53	706,63	BBN001631320160000.	277,57	310,55	398,60
1000	300	BBN001651510160000.	473,35	540,91	720,45	BBN001651320160000.	281,96	315,74	405,51
1000	400	BBN001671510160000.	650,77	749,71	1.013,85	BBN001671320160000.	370,67	420,14	552,21

H2120 mm

Module mm	Shelf depth mm	Item no. Freestanding bay	Melamine EUR	Painted EUR	Veneer EUR	Item no. Intermediate bay	Melamine EUR	Painted EUR	Veneer EUR
500	250	BBN001735510160000.	496,75	570,43	766,75	BBN001735320160000.	288,34	325,18	423,34
500	300	BBN001755510160000.	504,73	579,75	779,51	BBN001755320160000.	292,33	329,84	429,72
500	400	BBN001775510160000.	694,65	803,19	1.092,07	BBN001775320160000.	387,29	441,56	586,00
750	250	BBN001737510160000.	496,75	570,43	766,75	BBN001737320160000.	288,34	325,18	423,34
750	300	BBN001757510160000.	504,73	579,75	779,51	BBN001757320160000.	292,33	329,84	429,72
750	400	BBN001777510160000.	694,65	803,19	1.092,07	BBN001777320160000.	387,29	441,56	586,00
900	250	BBN001739510160000.	496,75	570,43	766,75	BBN001739320160000.	288,34	325,18	423,34
900	300	BBN001759510160000.	504,73	579,75	779,51	BBN001759320160000.	292,33	329,84	429,72
900	400	BBN001779510160000.	694,65	803,19	1.092,07	BBN001779320160000.	387,29	441,56	586,00
1000	250	BBN001731510160000.	507,39	581,07	777,39	BBN001731320160000.	298,98	335,82	433,98
1000	300	BBN001751510160000.	515,37	590,39	790,15	BBN001751320160000.	302,97	340,48	440,36
1000	400	BBN001771510160000.	705,29	813,83	1.102,71	BBN001771320160000.	397,93	452,20	596,64

LINGO SHELVING SYSTEM

DOUBLE-SIDED - STEEL BACK FRAME - ADJUSTABLE FEET - FOR TOP SHELF

Painted and veneered Lingo Shelving Systems are FSC-certified.

H720 mm

Module mm	Shelf depth mm	Item no. Freestanding bay	Melamine EUR	Painted EUR	Veneer EUR	Item no. Intermediate bay	Melamine EUR	Painted EUR	Veneer EUR
500	250	BBN001245510160000.	321,99	364,55	478,39	BBN001245320160000.	200,96	222,24	279,16
500	300	BBN001265510160000.	397,53	453,39	627,09	BBN001265320160000.	238,73	266,66	341,54
500	400	BBN001285510160000.	541,45	622,83	840,15	BBN001285320160000.	310,69	351,38	460,04
750	250	BBN001247510160000.	321,99	364,55	478,39	BBN001247320160000.	200,96	222,24	279,16
750	300	BBN001267510160000.	397,53	453,39	627,09	BBN001267320160000.	238,73	266,66	341,54
750	400	BBN001287510160000.	541,45	622,83	840,15	BBN001287320160000.	310,69	351,38	460,04
900	250	BBN001249510160000.	321,99	364,55	478,39	BBN001249320160000.	200,96	222,24	279,16
900	300	BBN001269510160000.	397,53	453,39	627,09	BBN001269320160000.	238,73	266,66	341,54
900	400	BBN001289510160000.	541,45	622,83	840,15	BBN001289320160000.	310,69	351,38	460,04
1000	250	BBN001241510160000.	332,63	375,19	489,03	BBN001241320160000.	211,60	232,88	289,80
1000	300	BBN001261510160000.	408,17	464,03	637,73	BBN001261320160000.	249,37	277,30	352,18
1000	400	BBN001281510160000.	552,09	633,47	850,79	BBN001281320160000.	321,33	362,02	470,68

H920 mm

Module mm	Shelf depth mm	Item no. Freestanding bay	Melamine EUR	Painted EUR	Veneer EUR	Item no. Intermediate bay	Melamine EUR	Painted EUR	Veneer EUR
500	250	BBN001345510160000.	389,03	443,55	589,05	BBN001345320160000.	234,48	261,74	334,49
500	300	BBN001365510160000.	485,85	557,67	748,93	BBN001365320160000.	282,89	318,80	414,43
500	400	BBN001385510160000.	669,65	773,39	1.050,83	BBN001385320160000.	374,79	426,66	565,38
750	250	BBN001347510160000.	389,03	443,55	589,05	BBN001347320160000.	234,48	261,74	334,49
750	300	BBN001367510160000.	485,85	557,67	748,93	BBN001367320160000.	282,89	318,80	414,43
750	400	BBN001387510160000.	669,65	773,39	1.050,83	BBN001387320160000.	374,79	426,66	565,38
900	250	BBN001349510160000.	389,03	443,55	589,05	BBN001349320160000.	234,48	261,74	334,49
900	300	BBN001369510160000.	485,85	557,67	748,93	BBN001369320160000.	282,89	318,80	414,43
900	400	BBN001389510160000.	669,65	773,39	1.050,83	BBN001389320160000.	374,79	426,66	565,38
1000	250	BBN001341510160000.	399,67	454,19	599,69	BBN001341320160000.	245,12	272,38	345,13
1000	300	BBN001361510160000.	496,49	568,31	759,57	BBN001361320160000.	293,53	329,44	425,07
1000	400	BBN001381510160000.	680,29	784,03	1.061,47	BBN001381320160000.	385,43	437,30	576,02

H1220 mm

Module mm	Shelf depth mm	Item no. Freestanding bay	Melamine EUR	Painted EUR	Veneer EUR	Item no. Intermediate bay	Melamine EUR	Painted EUR	Veneer EUR
500	250	BBN001445510160000.	487,71	559,79	752,11	BBN001445320160000.	283,82	319,86	416,02
500	300	BBN001465510160000.	607,41	700,51	949,21	BBN001465320160000.	343,67	390,22	514,57
500	400	BBN001485510160000.	846,55	981,93	1.343,17	BBN001485320160000.	463,24	530,93	711,55
750	250	BBN001447510160000.	487,71	559,79	752,11	BBN001447320160000.	283,82	319,86	416,02
750	300	BBN001467510160000.	607,41	700,51	949,21	BBN001467320160000.	343,67	390,22	514,57
750	400	BBN001487510160000.	846,55	981,93	1.343,17	BBN001487320160000.	463,24	530,93	711,55
900	250	BBN001449510160000.	487,71	559,79	752,11	BBN001449320160000.	283,82	319,86	416,02
900	300	BBN001469510160000.	607,41	700,51	949,21	BBN001469320160000.	343,67	390,22	514,57
900	400	BBN001489510160000.	846,55	981,93	1.343,17	BBN001489320160000.	463,24	530,93	711,55
1000	250	BBN001441510160000.	498,35	570,43	762,75	BBN001441320160000.	294,46	330,50	426,66
1000	300	BBN001461510160000.	618,05	711,15	959,85	BBN001461320160000.	354,31	400,86	525,21
1000	400	BBN001481510160000.	857,19	992,57	1.353,81	BBN001481320160000.	473,88	541,57	722,19

LINGO SHELVING SYSTEM

DOUBLE-SIDED - STEEL BACK FRAME - ADJUSTABLE FEET - FOR TOP SHELF

Painted and veneered Lingo Shelving Systems are FSC-certified.

H1520 mm

Module mm	Shelf depth mm	Item no. Freestanding bay	Melamine EUR	Painted EUR	Veneer EUR	Item no. Intermediate bay	Melamine EUR	Painted EUR	Veneer EUR
500	250	BBN001545510160000.	559,27	639,59	853,45	BBN001545320160000.	331,57	371,73	478,66
500	300	BBN001565510160000.	659,55	757,69	1.019,71	BBN001565320160000.	381,71	430,78	561,79
500	400	BBN001585510160000.	910,91	1.053,49	1.433,33	BBN001585320160000.	507,39	578,68	768,60
750	250	BBN001547510160000.	559,27	639,59	853,45	BBN001547320160000.	331,57	371,73	478,66
750	300	BBN001567510160000.	659,55	757,69	1.019,71	BBN001567320160000.	381,71	430,78	561,79
750	400	BBN001587510160000.	910,91	1.053,49	1.433,33	BBN001587320160000.	507,39	578,68	768,60
900	250	BBN001549510160000.	559,27	639,59	853,45	BBN001549320160000.	331,57	371,73	478,66
900	300	BBN001569510160000.	659,55	757,69	1.019,71	BBN001569320160000.	381,71	430,78	561,79
900	400	BBN001589510160000.	910,91	1.053,49	1.433,33	BBN001589320160000.	507,39	578,68	768,60
1000	250	BBN001541510160000.	572,84	653,16	867,02	BBN001541320160000.	345,14	385,30	492,23
1000	300	BBN001561510160000.	673,12	771,26	1.033,28	BBN001561320160000.	395,28	444,35	575,36
1000	400	BBN001581510160000.	924,48	1.067,06	1.446,90	BBN001581320160000.	520,96	592,25	782,17

H1820 mm

Module mm	Shelf depth mm	Item no. Freestanding bay	Melamine EUR	Painted EUR	Veneer EUR	Item no. Intermediate bay	Melamine EUR	Painted EUR	Veneer EUR
500	250	BBN001645510160000.	696,92	791,88	1.045,38	BBN001645320160000.	268,53	397,00	523,75
500	300	BBN001665510160000.	816,34	932,60	1.241,42	BBN001665320160000.	409,23	467,36	621,77
500	400	BBN001685510160000.	1.114,80	1.283,44	1.733,52	BBN001685320160000.	558,46	642,78	867,82
750	250	BBN001647510160000.	696,92	791,88	1.045,38	BBN001647320160000.	349,52	397,00	523,75
750	300	BBN001667510160000.	816,34	932,60	1.241,42	BBN001667320160000.	409,23	467,36	621,77
750	400	BBN001687510160000.	1.114,80	1.283,44	1.733,52	BBN001687320160000.	558,46	642,78	867,82
900	250	BBN001649510160000.	696,92	791,88	1.045,38	BBN001649320160000.	349,52	397,00	523,75
900	300	BBN001669510160000.	816,34	932,60	1.241,42	BBN001669320160000.	409,23	467,36	621,77
900	400	BBN001689510160000.	1.114,80	1.283,44	1.733,52	BBN001689320160000.	558,46	642,78	867,82
1000	250	BBN001641510160000.	718,20	813,16	1.066,66	BBN001641320160000.	360,16	407,64	534,39
1000	300	BBN001661510160000.	837,62	953,88	1.262,70	BBN001661320160000.	419,87	478,00	632,41
1000	400	BBN001681510160000.	1.136,08	1.304,72	1.754,80	BBN001681320160000.	569,10	653,42	878,46

H2120 mm

Module mm	Shelf depth mm	Item no. Freestanding bay	Melamine EUR	Painted EUR	Veneer EUR	Item no. Intermediate bay	Melamine EUR	Painted EUR	Veneer EUR
500	250	BBN001745510160000.	766,60	873,54	1.159,48	BBN001745320160000.	384,36	437,83	580,80
500	300	BBN001765510160000.	913,70	1.046,98	1.401,82	BBN001765320160000.	457,91	524,55	701,97
500	400	BBN001785510160000.	1.257,12	1.450,22	1.966,80	BBN001785320160000.	629,62	726,17	984,46
750	250	BBN001747510160000.	766,60	873,54	1.159,48	BBN001747320160000.	384,36	437,83	580,80
750	300	BBN001767510160000.	913,70	1.046,98	1.401,82	BBN001767320160000.	457,91	524,55	701,97
750	400	BBN001787510160000.	1.257,12	1.450,22	1.966,80	BBN001787320160000.	629,62	726,17	984,46
900	250	BBN001749510160000.	766,60	873,54	1.159,48	BBN001749320160000.	384,36	437,83	580,80
900	300	BBN001769510160000.	913,70	1.046,98	1.401,82	BBN001769320160000.	457,91	524,55	701,97
900	400	BBN001789510160000.	1.257,12	1.450,22	1.966,80	BBN001789320160000.	629,62	726,17	984,46
1000	250	BBN001741510160000.	787,88	894,82	1.180,76	BBN001741320160000.	395,00	448,47	591,44
1000	300	BBN001761510160000.	934,98	1.068,26	1.423,10	BBN001761320160000.	468,55	535,19	712,61
1000	400	BBN001781510160000.	1.278,40	1.471,50	1.988,08	BBN001781320160000.	640,26	736,81	995,10

LINGO SHELVING SYSTEM

BBN001 - HIGH WOODEN BACK PANEL - ADJUSTABLE FEET - FOR TOP SHELF



LINGO SHELVING SYSTEM

BBN001 - HIGH WOODEN BACK PANEL - ADJUSTABLE FEET - FOR TOP SHELF

Shelving system with wooden panels, high wooden back panel and castor plate. To be used with ST1 standard depth, ST1 double-sided, ST2, ST3 and WT1 standard depth top shelf.

Freestanding bay includes 2 outer panels and 1 wooden back panel.

Intermediate bay includes 1 intermediate panel and 1 wooden back panel.

- Prices based on steel price group 1 and wooden price group A (see Design Options pages 6-9).

- For top shelves, see pages 156 & 174

- For shelves see page 144 & 166.

- For accessories see page 186.

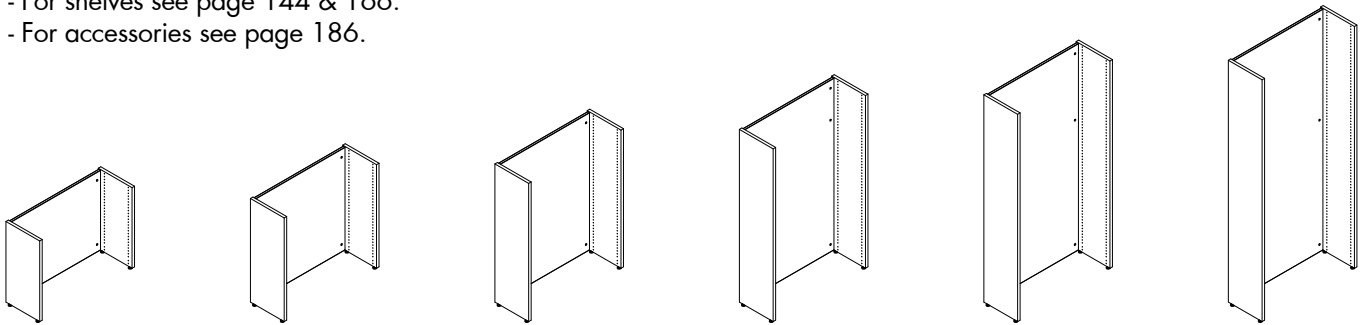

Single-sided freestanding bay - H720/920/1220/1520/1820/2120 mm

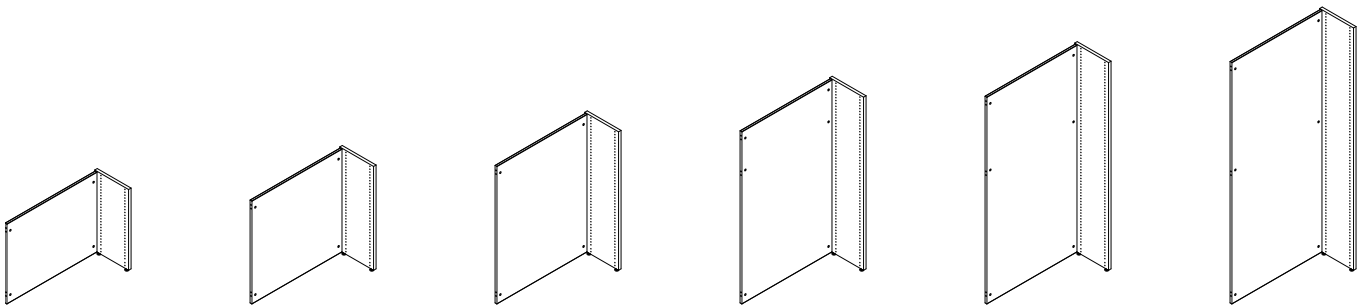

Single-sided intermediate bay - H720/920/1220/1520/1820/2120 mm

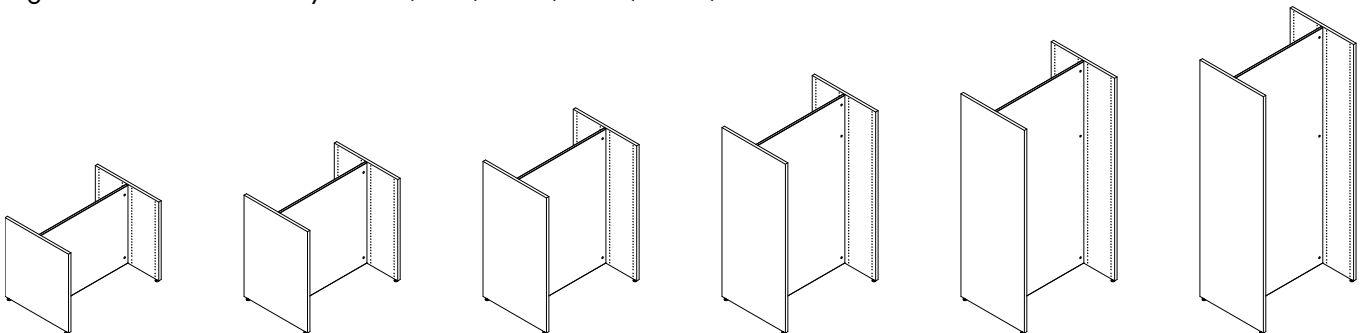

Double-sided freestanding bay - H720/920/1220/1520/1820/2120 mm

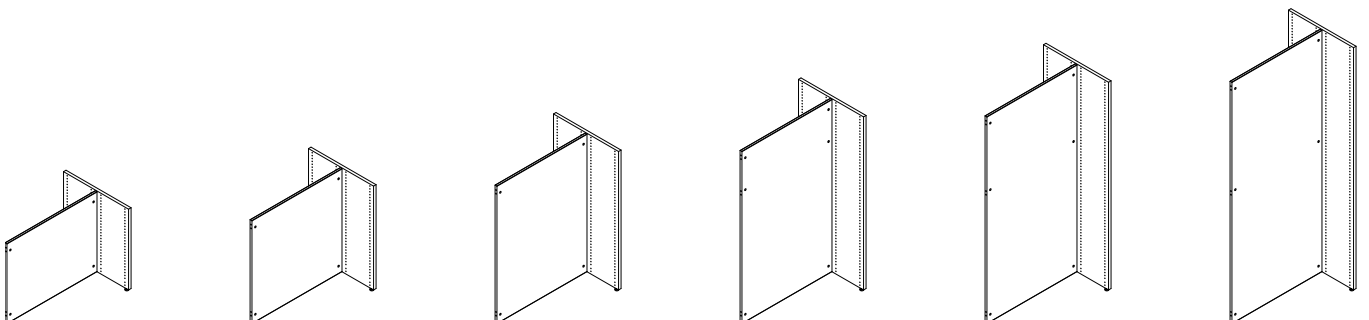

Double-sided intermediate bay - H720/920/1220/1520/1820/2120 mm

LINGO SHELVING SYSTEM

SINGLE-SIDED - HIGH WOODEN BACK PANEL - ADJUSTABLE FEET - FOR TOP SHELF

Painted and veneered Lingo Shelving Systems are FSC-certified.

H720 mm

Module mm	Shelf depth mm	Item no. Freestanding bay	Melamine EUR	Painted EUR	Veneer EUR	Item no. Intermediate bay	Melamine EUR	Painted EUR	Veneer EUR
500	250	BBN001235510120000.	234,89	276,51	387,56	BBN001235320120000.	152,16	179,02	250,97
500	300	BBN001255510120000.	259,09	304,43	426,94	BBN001255320120000.	164,26	192,98	270,66
500	400	BBN001275510120000.	326,39	383,97	537,86	BBN001275320120000.	197,91	232,75	326,12
750	250	BBN001237510120000.	269,47	317,47	445,02	BBN001237320120000.	186,74	219,98	308,43
750	300	BBN001257510120000.	293,67	345,39	484,40	BBN001257320120000.	198,84	233,94	328,12
750	400	BBN001277510120000.	360,97	424,93	595,32	BBN001277320120000.	232,49	273,71	383,58
900	250	BBN001239510120000.	295,53	347,93	487,44	BBN001239320120000.	212,80	250,44	350,85
900	300	BBN001259510120000.	319,73	375,85	526,82	BBN001259320120000.	224,90	264,40	370,54
900	400	BBN001279510120000.	387,03	455,39	637,74	BBN001279320120000.	258,55	304,17	426,00
1000	250	BBN001231510120000.	304,18	358,30	501,67	BBN001231320120000.	221,45	260,81	365,08
1000	300	BBN001251510120000.	328,38	386,22	541,05	BBN001251320120000.	233,55	274,77	384,77
1000	400	BBN001271510120000.	395,68	465,76	651,97	BBN001271320120000.	267,20	314,54	440,23

H920 mm

Module mm	Shelf depth mm	Item no. Freestanding bay	Melamine EUR	Painted EUR	Veneer EUR	Item no. Intermediate bay	Melamine EUR	Painted EUR	Veneer EUR
500	250	BBN001335510120000.	300,71	353,91	495,15	BBN001335320120000.	194,71	229,16	320,79
500	300	BBN001355510120000.	331,31	389,57	546,23	BBN001355320120000.	210,01	246,99	346,33
500	400	BBN001375510120000.	417,23	490,65	687,47	BBN001375320120000.	252,97	297,53	416,95
750	250	BBN001337510120000.	345,13	406,04	568,04	BBN001337320120000.	239,13	281,29	393,68
750	300	BBN001357510120000.	375,73	441,70	619,12	BBN001357320120000.	254,43	299,12	419,22
750	400	BBN001377510120000.	461,65	542,78	760,36	BBN001377320120000.	297,39	349,66	489,84
900	250	BBN001339510120000.	378,38	445,28	622,83	BBN001339320120000.	272,38	320,53	448,47
900	300	BBN001359510120000.	408,98	480,94	673,91	BBN001359320120000.	287,68	338,36	474,01
900	400	BBN001379510120000.	494,90	582,02	815,15	BBN001379320120000.	330,64	388,90	544,63
1000	250	BBN001331510120000.	389,42	458,18	640,52	BBN001331320120000.	283,42	333,43	466,16
1000	300	BBN001351510120000.	420,02	493,84	691,60	BBN001351320120000.	298,72	351,26	491,70
1000	400	BBN001371510120000.	505,94	594,92	832,84	BBN001371320120000.	341,68	401,80	562,32

H1220 mm

Module mm	Shelf depth mm	Item no. Freestanding bay	Melamine EUR	Painted EUR	Veneer EUR	Item no. Intermediate bay	Melamine EUR	Painted EUR	Veneer EUR
500	250	BBN001435510120000.	399,01	469,22	657,54	BBN001435320120000.	258,69	304,30	426,39
500	300	BBN001455510120000.	411,23	483,86	677,24	BBN001455320120000.	264,80	311,62	436,24
500	400	BBN001475510120000.	543,17	639,20	894,82	BBN001475320120000.	330,77	389,29	545,03
750	250	BBN001437510120000.	458,59	539,05	755,03	BBN001437320120000.	318,27	374,13	523,88
750	300	BBN001457510120000.	470,81	553,69	774,73	BBN001457320120000.	324,38	381,45	533,73
750	400	BBN001477510120000.	602,75	709,03	992,31	BBN001477320120000.	390,35	459,12	642,52
900	250	BBN001439510120000.	495,17	582,27	815,95	BBN001439320120000.	354,85	417,35	584,80
900	300	BBN001459510120000.	507,39	596,91	835,65	BBN001459320120000.	360,96	424,67	594,65
900	400	BBN001479510120000.	639,33	752,25	1.053,23	BBN001479320120000.	426,93	502,34	703,44
1000	250	BBN001431510120000.	517,38	608,34	851,99	BBN001431320120000.	377,06	443,42	620,84
1000	300	BBN001451510120000.	529,60	622,98	871,69	BBN001451320120000.	383,17	450,74	630,69
1000	400	BBN001471510120000.	661,54	778,32	1.089,27	BBN001471320120000.	449,14	528,41	739,48

LINGO SHELVING SYSTEM

SINGLE-SIDED - HIGH WOODEN BACK PANEL - ADJUSTABLE FEET - FOR TOP SHELF

Painted and veneered Lingo Shelving Systems are FSC-certified.

H1520 mm

Module mm	Shelf depth mm	Item no. Freestanding bay	Melamine EUR	Painted EUR	Veneer EUR	Item no. Intermediate bay	Melamine EUR	Painted EUR	Veneer EUR
500	250	BBN001535510120000.	463,91	545,83	764,23	BBN001535320120000.	304,44	358,17	501,55
500	300	BBN001555510120000.	475,87	560,21	783,63	BBN001555320120000.	310,42	365,36	511,25
500	400	BBN001575510120000.	634,67	746,67	1.044,85	BBN001575320120000.	389,82	458,59	641,86
750	250	BBN001537510120000.	536,40	631,21	883,53	BBN001537320120000.	376,93	443,55	620,85
750	300	BBN001557510120000.	548,36	645,59	902,93	BBN001557320120000.	382,91	450,74	630,55
750	400	BBN001577510120000.	707,16	832,05	1.164,15	BBN001577320120000.	462,31	543,97	761,16
900	250	BBN001539510120000.	584,81	688,14	963,60	BBN001539320120000.	425,34	500,48	700,92
900	300	BBN001559510120000.	596,77	702,52	983,00	BBN001559320120000.	431,32	507,67	710,62
900	400	BBN001579510120000.	755,57	888,98	1.244,22	BBN001579320120000.	510,72	600,90	841,23
1000	250	BBN001531510120000.	609,28	717,00	1.003,23	BBN001531320120000.	449,81	529,34	740,55
1000	300	BBN001551510120000.	621,24	731,38	1.022,63	BBN001551320120000.	455,79	536,53	750,25
1000	400	BBN001571510120000.	780,04	917,84	1.283,85	BBN001571320120000.	535,19	629,76	880,86

H1820 mm

Module mm	Shelf depth mm	Item no. Freestanding bay	Melamine EUR	Painted EUR	Veneer EUR	Item no. Intermediate bay	Melamine EUR	Painted EUR	Veneer EUR
500	250	BBN001635510120000.	542,25	637,86	892,83	BBN001635320120000.	355,25	417,88	584,80
500	300	BBN001655510120000.	551,03	648,24	906,65	BBN001655320120000.	359,64	423,07	591,71
500	400	BBN001675510120000.	728,45	857,04	1.200,05	BBN001675320120000.	448,35	527,47	738,41
750	250	BBN001637510120000.	626,17	736,55	1.031,42	BBN001637320120000.	439,17	516,57	723,39
750	300	BBN001657510120000.	634,95	746,93	1.045,24	BBN001657320120000.	443,56	521,76	730,30
750	400	BBN001677510120000.	812,37	955,73	1.338,64	BBN001677320120000.	532,27	626,16	877,00
900	250	BBN001639510120000.	687,22	808,64	1.131,83	BBN001639320120000.	500,22	588,66	823,80
900	300	BBN001659510120000.	696,00	819,02	1.145,65	BBN001659320120000.	504,61	593,85	830,71
900	400	BBN001679510120000.	873,42	1.027,82	1.439,05	BBN001679320120000.	593,32	698,25	977,41
1000	250	BBN001631510120000.	710,09	835,37	1.169,61	BBN001631320120000.	523,09	615,39	861,58
1000	300	BBN001651510120000.	718,87	845,75	1.183,43	BBN001651320120000.	527,48	620,58	868,49
1000	400	BBN001671510120000.	896,29	1.054,55	1.476,83	BBN001671320120000.	616,19	724,98	1.015,19

H2120 mm

Module mm	Shelf depth mm	Item no. Freestanding bay	Melamine EUR	Painted EUR	Veneer EUR	Item no. Intermediate bay	Melamine EUR	Painted EUR	Veneer EUR
500	250	BBN001735510120000.	611,27	718,99	1.006,95	BBN001735320120000.	402,86	473,74	663,54
500	300	BBN001755510120000.	619,25	728,31	1.019,71	BBN001755320120000.	406,85	478,40	669,92
500	400	BBN001775510120000.	809,17	951,75	1.332,27	BBN001775320120000.	501,81	590,12	826,20
750	250	BBN001737510120000.	708,09	833,37	1.166,42	BBN001737320120000.	499,68	588,12	823,01
750	300	BBN001757510120000.	716,07	842,69	1.179,18	BBN001757320120000.	503,67	592,78	829,39
750	400	BBN001777510120000.	905,99	1.066,13	1.491,74	BBN001777320120000.	598,63	704,50	985,67
900	250	BBN001739510120000.	778,31	915,83	1.282,53	BBN001739320120000.	569,90	670,58	939,12
900	300	BBN001759510120000.	786,29	925,15	1.295,29	BBN001759320120000.	573,89	675,24	945,50
900	400	BBN001779510120000.	976,21	1.148,59	1.607,85	BBN001779320120000.	668,85	786,96	1.101,78
1000	250	BBN001731510120000.	805,05	947,36	1.326,42	BBN001731320120000.	596,64	702,11	983,01
1000	300	BBN001751510120000.	813,03	956,68	1.339,18	BBN001751320120000.	600,63	706,77	989,39
1000	400	BBN001771510120000.	1.002,95	1.180,12	1.651,74	BBN001771320120000.	695,59	818,49	1.145,67

LINGO SHELVING SYSTEM

DOUBLE-SIDED - HIGH WOODEN BACK PANEL - ADJUSTABLE FEET - FOR TOP SHELF

Painted and veneered Lingo Shelving Systems are FSC-certified.

H720 mm

Module mm	Shelf depth mm	Item no. Freestanding bay	Melamine EUR	Painted EUR	Veneer EUR	Item no. Intermediate bay	Melamine EUR	Painted EUR	Veneer EUR
500	250	BBN001245510120000.	311,49	366,15	512,84	BBN001245320120000.	190,46	223,84	313,61
500	300	BBN001265510120000.	387,03	454,99	661,54	BBN001265320120000.	228,23	268,26	375,99
500	400	BBN001285510120000.	530,95	624,43	874,60	BBN001285320120000.	300,19	352,98	494,49
750	250	BBN001247510120000.	346,07	407,11	570,30	BBN001247320120000.	225,04	264,80	371,07
750	300	BBN001267510120000.	421,61	495,95	719,00	BBN001267320120000.	262,81	309,22	433,45
750	400	BBN001287510120000.	565,53	665,39	932,06	BBN001287320120000.	334,77	393,94	551,95
900	250	BBN001249510120000.	372,13	437,57	612,72	BBN001249320120000.	251,10	295,26	413,49
900	300	BBN001269510120000.	447,67	526,41	761,42	BBN001269320120000.	288,87	339,68	475,87
900	400	BBN001289510120000.	591,59	695,85	974,48	BBN001289320120000.	360,83	424,40	594,37
1000	250	BBN001241510120000.	380,78	447,94	626,95	BBN001241320120000.	259,75	305,63	427,72
1000	300	BBN001261510120000.	456,32	536,78	775,65	BBN001261320120000.	297,52	350,05	490,10
1000	400	BBN001281510120000.	600,24	706,22	988,71	BBN001281320120000.	369,48	434,77	608,60

H920 mm

Module mm	Shelf depth mm	Item no. Freestanding bay	Melamine EUR	Painted EUR	Veneer EUR	Item no. Intermediate bay	Melamine EUR	Painted EUR	Veneer EUR
500	250	BBN001345510120000.	397,81	468,03	655,55	BBN001345320120000.	243,26	286,22	400,99
500	300	BBN001365510120000.	494,63	582,15	815,43	BBN001365320120000.	291,67	343,28	480,93
500	400	BBN001385510120000.	678,43	797,87	1.117,33	BBN001385320120000.	383,57	451,14	631,88
750	250	BBN001347510120000.	442,23	520,16	728,44	BBN001347320120000.	287,68	338,35	473,88
750	300	BBN001367510120000.	539,05	634,28	888,32	BBN001367320120000.	336,09	395,41	553,82
750	400	BBN001387510120000.	722,85	850,00	1.190,22	BBN001387320120000.	427,99	503,27	704,77
900	250	BBN001349510120000.	475,48	559,40	783,23	BBN001349320120000.	320,93	377,59	528,67
900	300	BBN001369510120000.	572,30	673,52	943,11	BBN001369320120000.	369,34	434,65	608,61
900	400	BBN001389510120000.	756,10	889,24	1.245,01	BBN001389320120000.	461,24	542,51	759,56
1000	250	BBN001341510120000.	486,52	572,30	800,92	BBN001341320120000.	331,97	390,49	546,36
1000	300	BBN001361510120000.	583,34	686,42	960,80	BBN001361320120000.	380,38	447,55	626,30
1000	400	BBN001381510120000.	767,14	902,14	1.262,70	BBN001381320120000.	472,28	555,41	777,25

H1220 mm

Module mm	Shelf depth mm	Item no. Freestanding bay	Melamine EUR	Painted EUR	Veneer EUR	Item no. Intermediate bay	Melamine EUR	Painted EUR	Veneer EUR
500	250	BBN001445510120000.	526,15	619,24	867,42	BBN001445320120000.	322,26	379,31	531,33
500	300	BBN001465510120000.	645,85	759,96	1.064,52	BBN001465320120000.	382,11	449,67	629,88
500	400	BBN001485510120000.	884,99	1.041,38	1.458,48	BBN001485320120000.	501,68	590,38	826,86
750	250	BBN001447510120000.	585,73	689,07	964,91	BBN001447320120000.	381,84	449,14	628,82
750	300	BBN001467510120000.	705,43	829,79	1.162,01	BBN001467320120000.	441,69	519,50	727,37
750	400	BBN001487510120000.	944,57	1.111,21	1.555,97	BBN001487320120000.	561,26	660,21	924,35
900	250	BBN001449510120000.	622,31	732,29	1.025,83	BBN001449320120000.	418,42	492,36	689,74
900	300	BBN001469510120000.	742,01	873,01	1.222,93	BBN001469320120000.	478,27	562,72	788,29
900	400	BBN001489510120000.	981,15	1.154,43	1.616,89	BBN001489320120000.	597,84	703,43	985,27
1000	250	BBN001441510120000.	644,52	758,36	1.061,87	BBN001441320120000.	440,63	518,43	725,78
1000	300	BBN001461510120000.	764,22	899,08	1.258,97	BBN001461320120000.	500,48	588,79	824,33
1000	400	BBN001481510120000.	1.003,36	1.180,50	1.652,93	BBN001481320120000.	620,05	729,50	1.021,31

LINGO SHELVING SYSTEM

DOUBLE-SIDED - HIGH WOODEN BACK PANEL - ADJUSTABLE FEET - FOR TOP SHELF

Painted and veneered Lingo Shelving Systems are FSC-certified.

H1520 mm

Module mm	Shelf depth mm	Item no. Freestanding bay	Melamine EUR	Painted EUR	Veneer EUR	Item no. Intermediate bay	Melamine EUR	Painted EUR	Veneer EUR
500	250	BBN001545510120000.	600,37	706,23	988,45	BBN001545320120000.	372,67	438,37	613,66
500	300	BBN001565510120000.	700,65	824,33	1.154,71	BBN001565320120000.	422,81	497,42	696,79
500	400	BBN001585510120000.	952,01	1.120,13	1.568,33	BBN001585320120000.	548,49	645,32	903,60
750	250	BBN001547510120000.	672,86	791,61	1.107,75	BBN001547320120000.	445,16	523,75	732,96
750	300	BBN001567510120000.	773,14	909,71	1.274,01	BBN001567320120000.	495,30	582,80	816,09
750	400	BBN001587510120000.	1.024,50	1.205,51	1.687,63	BBN001587320120000.	620,98	730,70	1.022,90
900	250	BBN001549510120000.	721,27	848,54	1.187,82	BBN001549320120000.	493,57	580,68	813,03
900	300	BBN001569510120000.	821,55	966,64	1.354,08	BBN001569320120000.	543,71	639,73	896,16
900	400	BBN001589510120000.	1.072,91	1.262,44	1.767,70	BBN001589320120000.	669,39	787,63	1.102,97
1000	250	BBN001541510120000.	745,74	877,40	1.227,45	BBN001541320120000.	518,04	609,54	852,66
1000	300	BBN001561510120000.	846,02	995,50	1.393,71	BBN001561320120000.	568,18	668,59	935,79
1000	400	BBN001581510120000.	1.097,38	1.291,30	1.807,33	BBN001581320120000.	693,86	816,49	1.142,60

H1820 mm

Module mm	Shelf depth mm	Item no. Freestanding bay	Melamine EUR	Painted EUR	Veneer EUR	Item no. Intermediate bay	Melamine EUR	Painted EUR	Veneer EUR
500	250	BBN001645510120000.	705,31	829,92	1.162,29	BBN001645320120000.	436,78	513,91	719,53
500	300	BBN001665510120000.	824,73	970,64	1.358,33	BBN001665320120000.	496,49	584,27	817,55
500	400	BBN001685510120000.	1.123,19	1.321,48	1.850,43	BBN001685320120000.	645,72	759,69	1.063,60
750	250	BBN001647510120000.	789,23	928,61	1.300,88	BBN001647320120000.	520,70	612,60	858,12
750	300	BBN001667510120000.	908,65	1.069,33	1.496,92	BBN001667320120000.	580,41	682,96	956,14
750	400	BBN001687510120000.	1.207,11	1.420,17	1.989,02	BBN001687320120000.	729,64	858,38	1.202,19
900	250	BBN001649510120000.	850,28	1.000,70	1.401,29	BBN001649320120000.	581,75	684,69	958,53
900	300	BBN001669510120000.	969,70	1.141,42	1.597,33	BBN001669320120000.	641,46	755,05	1.056,55
900	400	BBN001689510120000.	1.268,16	1.492,26	2.089,43	BBN001689320120000.	790,69	930,47	1.302,60
1000	250	BBN001641510120000.	873,15	1.027,43	1.439,07	BBN001641320120000.	604,62	711,42	996,31
1000	300	BBN001661510120000.	992,57	1.168,15	1.635,11	BBN001661320120000.	664,33	781,78	1.094,33
1000	400	BBN001681510120000.	1.291,03	1.518,99	2.127,21	BBN001681320120000.	813,56	957,20	1.340,38

H2120 mm

Module mm	Shelf depth mm	Item no. Freestanding bay	Melamine EUR	Painted EUR	Veneer EUR	Item no. Intermediate bay	Melamine EUR	Painted EUR	Veneer EUR
500	250	BBN001745510120000.	801,19	942,17	1.319,75	BBN001745320120000.	497,82	585,33	819,94
500	300	BBN001765510120000.	948,29	1.115,61	1.562,09	BBN001765320120000.	571,37	672,05	941,11
500	400	BBN001785510120000.	1.291,71	1.518,85	2.127,07	BBN001785320120000.	743,08	873,67	1.223,60
750	250	BBN001747510120000.	898,01	1.056,55	1.479,22	BBN001747320120000.	594,64	699,71	979,41
750	300	BBN001767510120000.	1.045,11	1.229,99	1.721,56	BBN001767320120000.	668,19	786,43	1.100,58
750	400	BBN001787510120000.	1.388,53	1.633,23	2.286,54	BBN001787320120000.	839,90	988,05	1.383,07
900	250	BBN001749510120000.	968,23	1.139,01	1.595,33	BBN001749320120000.	664,86	782,17	1.095,52
900	300	BBN001769510120000.	1.115,33	1.312,45	1.837,67	BBN001769320120000.	738,41	868,89	1.216,69
900	400	BBN001789510120000.	1.458,75	1.715,69	2.402,65	BBN001789320120000.	910,12	1.070,51	1.499,18
1000	250	BBN001741510120000.	994,97	1.170,54	1.639,22	BBN001741320120000.	691,60	813,70	1.139,41
1000	300	BBN001761510120000.	1.142,07	1.343,98	1.881,56	BBN001761320120000.	765,15	900,42	1.260,58
1000	400	BBN001781510120000.	1.485,49	1.747,22	2.446,54	BBN001781320120000.	936,86	1.102,04	1.543,07

LINGO SHELVING SYSTEM

BBN001 - LOW WOODEN BACK PANEL - ADJUSTABLE FEET - FOR TOP SHELF



LINGO SHELVING SYSTEM

BBN001 - LOW WOODEN BACK PANEL - ADJUSTABLE FEET - FOR TOP SHELF

Shelving system with wooden panels and low wooden back panel.
To be used with ST1 full depth, WT1 full depth and WT1 double-sided top shelf.
Freestanding bay includes 2 outer panels and 1 wooden back panel.
Intermediate bay includes 1 intermediate panel and 1 wooden back panel.

- Prices based on steel price group 1 and wooden price group A (see Design Options pages 6-9).
- For top shelves, see pages 156 & 174
- For shelves see page 144 & 166.
- For accessories see page 186.

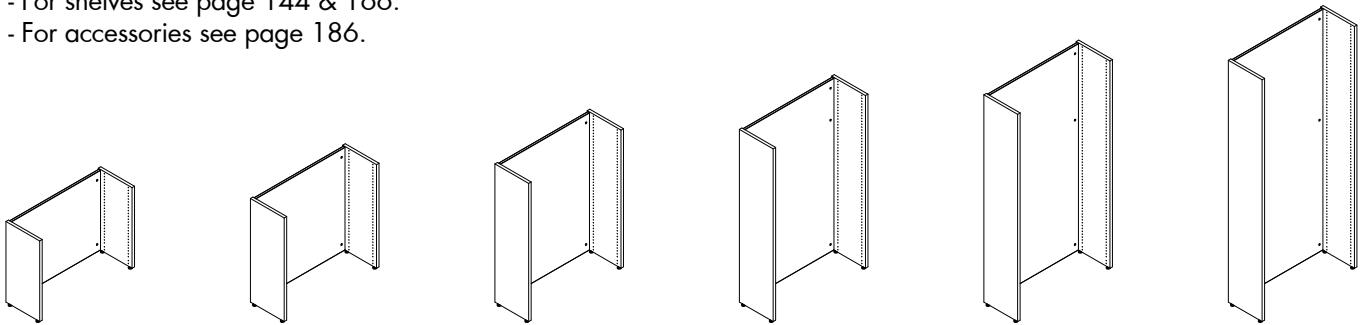

Single-sided freestanding bay - H720/920/1220/1520/1820/2120 mm

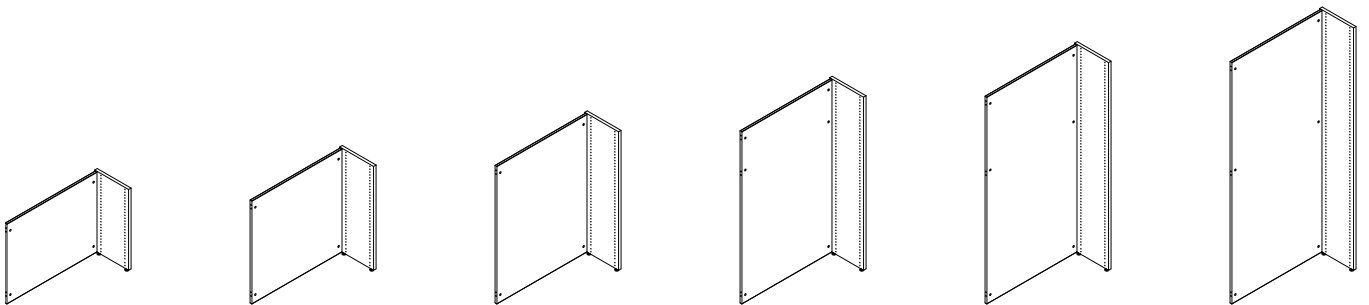

Single-sided intermediate bay - H720/920/1220/1520/1820/2120 mm

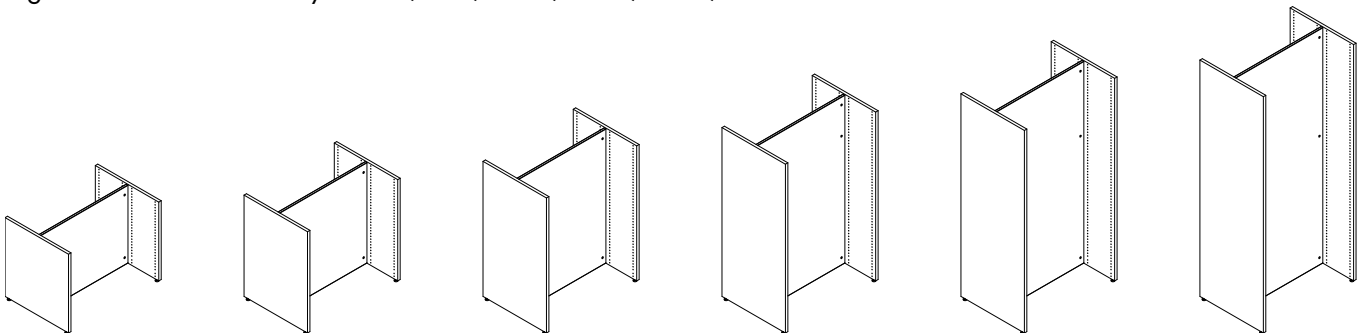

Double-sided freestanding bay - H720/920/1220/1520/1820/2120 mm

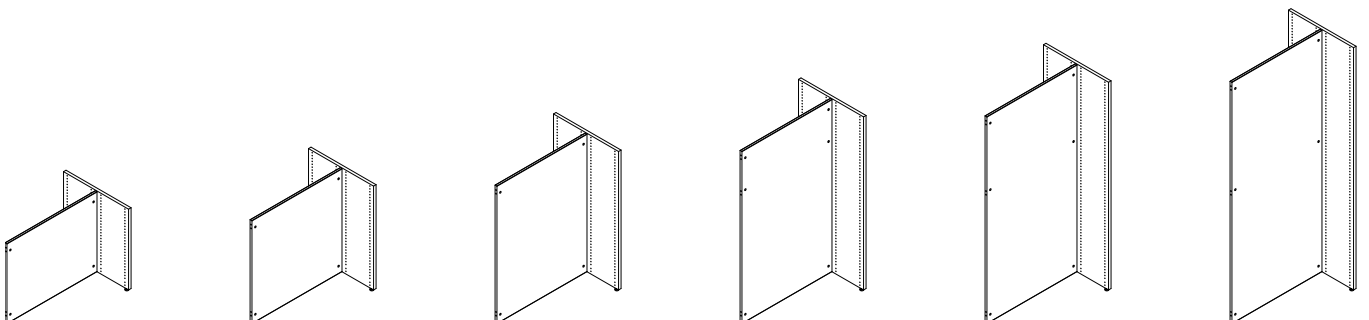

Double-sided intermediate bay - H720/920/1220/1520/1820/2120 mm

LINGO SHELVING SYSTEM

SINGLE-SIDED - LOW WOODEN BACK PANEL - ADJUSTABLE FEET - FOR TOP SHELF

Painted and veneered Lingo Shelving Systems are FSC-certified.

H720 mm

Module mm	Shelf depth mm	Item no. Freestanding bay	Melamine EUR	Painted EUR	Veneer EUR	Item no. Intermediate bay	Melamine EUR	Painted EUR	Veneer EUR
500	250	BBN001235510110000.	234,89	276,51	387,56	BBN001235320110000.	152,16	179,02	250,97
500	300	BBN001255510110000.	259,09	304,43	426,94	BBN001255320110000.	164,26	192,98	270,66
500	400	BBN001275510110000.	326,39	383,97	537,86	BBN001275320110000.	197,91	232,75	326,12
750	250	BBN001237510110000.	269,47	317,47	445,02	BBN001237320110000.	186,74	219,98	308,43
750	300	BBN001257510110000.	293,67	345,39	484,40	BBN001257320110000.	198,84	233,94	328,12
750	400	BBN001277510110000.	360,97	424,93	595,32	BBN001277320110000.	232,49	273,71	383,58
900	250	BBN001239510110000.	295,53	347,93	487,44	BBN001239320110000.	212,80	250,44	350,85
900	300	BBN001259510110000.	319,73	375,85	526,82	BBN001259320110000.	224,90	264,40	370,54
900	400	BBN001279510110000.	387,03	455,39	637,74	BBN001279320110000.	258,55	304,17	426,00
1000	250	BBN001231510110000.	304,18	358,30	501,67	BBN001231320110000.	221,45	260,81	365,08
1000	300	BBN001251510110000.	328,38	386,22	541,05	BBN001251320110000.	233,55	274,77	384,77
1000	400	BBN001271510110000.	395,68	465,76	651,97	BBN001271320110000.	267,20	314,54	440,23

H920 mm

Module mm	Shelf depth mm	Item no. Freestanding bay	Melamine EUR	Painted EUR	Veneer EUR	Item no. Intermediate bay	Melamine EUR	Painted EUR	Veneer EUR
500	250	BBN001335510110000.	300,71	353,91	495,15	BBN001335320110000.	194,71	229,16	320,79
500	300	BBN001355510110000.	331,31	389,57	546,23	BBN001355320110000.	210,01	246,99	346,33
500	400	BBN001375510110000.	417,23	490,65	687,47	BBN001375320110000.	252,97	297,53	416,95
750	250	BBN001337510110000.	345,13	406,04	568,04	BBN001337320110000.	239,13	281,29	393,68
750	300	BBN001357510110000.	375,73	441,70	619,12	BBN001357320110000.	254,43	299,12	419,22
750	400	BBN001377510110000.	461,65	542,78	760,36	BBN001377320110000.	297,39	349,66	489,84
900	250	BBN001339510110000.	378,38	445,28	622,83	BBN001339320110000.	272,38	320,53	448,47
900	300	BBN001359510110000.	408,98	480,94	673,91	BBN001359320110000.	287,68	338,36	474,01
900	400	BBN001379510110000.	494,90	582,02	815,15	BBN001379320110000.	330,64	388,90	544,63
1000	250	BBN001331510110000.	389,42	458,18	640,52	BBN001331320110000.	283,42	333,43	466,16
1000	300	BBN001351510110000.	420,02	493,84	691,60	BBN001351320110000.	298,72	351,26	491,70
1000	400	BBN001371510110000.	505,94	594,92	832,84	BBN001371320110000.	341,68	401,80	562,32

H1220 mm

Module mm	Shelf depth mm	Item no. Freestanding bay	Melamine EUR	Painted EUR	Veneer EUR	Item no. Intermediate bay	Melamine EUR	Painted EUR	Veneer EUR
500	250	BBN001435510110000.	399,01	469,22	657,54	BBN001435320110000.	258,69	304,30	426,39
500	300	BBN001455510110000.	411,23	483,86	677,24	BBN001455320110000.	264,80	311,62	436,24
500	400	BBN001475510110000.	543,17	639,20	894,82	BBN001475320110000.	330,77	389,29	545,03
750	250	BBN001437510110000.	458,59	539,05	755,03	BBN001437320110000.	318,27	374,13	523,88
750	300	BBN001457510110000.	470,81	553,69	774,73	BBN001457320110000.	324,38	381,45	533,73
750	400	BBN001477510110000.	602,75	709,03	992,31	BBN001477320110000.	390,35	459,12	642,52
900	250	BBN001439510110000.	495,17	582,27	815,95	BBN001439320110000.	354,85	417,35	584,80
900	300	BBN001459510110000.	507,39	596,91	835,65	BBN001459320110000.	360,96	424,67	594,65
900	400	BBN001479510110000.	639,33	752,25	1.053,23	BBN001479320110000.	426,93	502,34	703,44
1000	250	BBN001431510110000.	517,38	608,34	851,99	BBN001431320110000.	377,06	443,42	620,84
1000	300	BBN001451510110000.	529,60	622,98	871,69	BBN001451320110000.	383,17	450,74	630,69
1000	400	BBN001471510110000.	661,54	778,32	1.089,27	BBN001471320110000.	449,14	528,41	739,48

LINGO SHELVING SYSTEM

SINGLE-SIDED - LOW WOODEN BACK PANEL - ADJUSTABLE FEET - FOR TOP SHELF

Painted and veneered Lingo Shelving Systems are FSC-certified.

H1520 mm

Module mm	Shelf depth mm	Item no. Freestanding bay	Melamine EUR	Painted EUR	Veneer EUR	Item no. Intermediate bay	Melamine EUR	Painted EUR	Veneer EUR
500	250	BBN001535510110000.	463,91	545,83	764,23	BBN001535320110000.	304,44	358,17	501,55
500	300	BBN001555510110000.	475,87	560,21	783,63	BBN001555320110000.	310,42	365,36	511,25
500	400	BBN001575510110000.	634,67	746,67	1.044,85	BBN001575320110000.	389,82	458,59	641,86
750	250	BBN001537510110000.	536,40	631,21	883,53	BBN001537320110000.	376,93	443,55	620,85
750	300	BBN001557510110000.	548,36	645,59	902,93	BBN001557320110000.	382,91	450,74	630,55
750	400	BBN001577510110000.	707,16	832,05	1.164,15	BBN001577320110000.	462,31	543,97	761,16
900	250	BBN001539510110000.	584,81	688,14	963,60	BBN001539320110000.	425,34	500,48	700,92
900	300	BBN001559510110000.	596,77	702,52	983,00	BBN001559320110000.	431,32	507,67	710,62
900	400	BBN001579510110000.	755,57	888,98	1.244,22	BBN001579320110000.	510,72	600,90	841,23
1000	250	BBN001531510110000.	609,28	717,00	1.003,23	BBN001531320110000.	449,81	529,34	740,55
1000	300	BBN001551510110000.	621,24	731,38	1.022,63	BBN001551320110000.	455,79	536,53	750,25
1000	400	BBN001571510110000.	780,04	917,84	1.283,85	BBN001571320110000.	535,19	629,76	880,86

H1820 mm

Module mm	Shelf depth mm	Item no. Freestanding bay	Melamine EUR	Painted EUR	Veneer EUR	Item no. Intermediate bay	Melamine EUR	Painted EUR	Veneer EUR
500	250	BBN001635510110000.	542,25	637,86	892,83	BBN001635320110000.	355,25	417,88	584,80
500	300	BBN001655510110000.	551,03	648,24	906,65	BBN001655320110000.	359,64	423,07	591,71
500	400	BBN001675510110000.	728,45	857,04	1.200,05	BBN001675320110000.	448,35	527,47	738,41
750	250	BBN001637510110000.	626,17	736,55	1.031,42	BBN001637320110000.	439,17	516,57	723,39
750	300	BBN001657510110000.	634,95	746,93	1.045,24	BBN001657320110000.	443,56	521,76	730,30
750	400	BBN001677510110000.	812,37	955,73	1.338,64	BBN001677320110000.	532,27	626,16	877,00
900	250	BBN001639510110000.	687,22	808,64	1.131,83	BBN001639320110000.	500,22	588,66	823,80
900	300	BBN001659510110000.	696,00	819,02	1.145,65	BBN001659320110000.	504,61	593,85	830,71
900	400	BBN001679510110000.	873,42	1.027,82	1.439,05	BBN001679320110000.	593,32	698,25	977,41
1000	250	BBN001631510110000.	710,09	835,37	1.169,61	BBN001631320110000.	523,09	615,39	861,58
1000	300	BBN001651510110000.	718,87	845,75	1.183,43	BBN001651320110000.	527,48	620,58	868,49
1000	400	BBN001671510110000.	896,29	1.054,55	1.476,83	BBN001671320110000.	616,19	724,98	1.015,19

H2120 mm

Module mm	Shelf depth mm	Item no. Freestanding bay	Melamine EUR	Painted EUR	Veneer EUR	Item no. Intermediate bay	Melamine EUR	Painted EUR	Veneer EUR
500	250	BBN001735510110000.	611,27	718,99	1.006,95	BBN001735320110000.	402,86	473,74	663,54
500	300	BBN001755510110000.	619,25	728,31	1.019,71	BBN001755320110000.	406,85	478,40	669,92
500	400	BBN001775510110000.	809,17	951,75	1.332,27	BBN001775320110000.	501,81	590,12	826,20
750	250	BBN001737510110000.	708,09	833,37	1.166,42	BBN001737320110000.	499,68	588,12	823,01
750	300	BBN001757510110000.	716,07	842,69	1.179,18	BBN001757320110000.	503,67	592,78	829,39
750	400	BBN001777510110000.	905,99	1.066,13	1.491,74	BBN001777320110000.	598,63	704,50	985,67
900	250	BBN001739510110000.	778,31	915,83	1.282,53	BBN001739320110000.	569,90	670,58	939,12
900	300	BBN001759510110000.	786,29	925,15	1.295,29	BBN001759320110000.	573,89	675,24	945,50
900	400	BBN001779510110000.	976,21	1.148,59	1.607,85	BBN001779320110000.	668,85	786,96	1.101,78
1000	250	BBN001731510110000.	805,05	947,36	1.326,42	BBN001731320110000.	596,64	702,11	983,01
1000	300	BBN001751510110000.	813,03	956,68	1.339,18	BBN001751320110000.	600,63	706,77	989,39
1000	400	BBN001771510110000.	1.002,95	1.180,12	1.651,74	BBN001771320110000.	695,59	818,49	1.145,67

LINGO SHELVING SYSTEM

DOUBLE-SIDED - LOW WOODEN BACK PANEL - ADJUSTABLE FEET - FOR TOP SHELF

Painted and veneered Lingo Shelving Systems are FSC-certified.

H720 mm

Module mm	Shelf depth mm	Item no. Freestanding bay	Melamine EUR	Painted EUR	Veneer EUR	Item no. Intermediate bay	Melamine EUR	Painted EUR	Veneer EUR
500	250	BBN001245510110000.	311,49	366,15	512,84	BBN001245320110000.	190,46	223,84	313,61
500	300	BBN001265510110000.	387,03	454,99	661,54	BBN001265320110000.	228,23	268,26	375,99
500	400	BBN001285510110000.	530,95	624,43	874,60	BBN001285320110000.	300,19	352,98	494,49
750	250	BBN001247510110000.	346,07	407,11	570,30	BBN001247320110000.	225,04	264,80	371,07
750	300	BBN001267510110000.	421,61	495,95	719,00	BBN001267320110000.	262,81	309,22	433,45
750	400	BBN001287510110000.	565,53	665,39	932,06	BBN001287320110000.	334,77	393,94	551,95
900	250	BBN001249510110000.	372,13	437,57	612,72	BBN001249320110000.	251,10	295,26	413,49
900	300	BBN001269510110000.	447,67	526,41	761,42	BBN001269320110000.	288,87	339,68	475,87
900	400	BBN001289510110000.	591,59	695,85	974,48	BBN001289320110000.	360,83	424,40	594,37
1000	250	BBN001241510110000.	380,78	447,94	626,95	BBN001241320110000.	259,75	305,63	427,72
1000	300	BBN001261510110000.	456,32	536,78	775,65	BBN001261320110000.	297,52	350,05	490,10
1000	400	BBN001281510110000.	600,24	706,22	988,71	BBN001281320110000.	369,48	434,77	608,60

H920 mm

Module mm	Shelf depth mm	Item no. Freestanding bay	Melamine EUR	Painted EUR	Veneer EUR	Item no. Intermediate bay	Melamine EUR	Painted EUR	Veneer EUR
500	250	BBN001345510110000.	397,81	468,03	655,55	BBN001345320110000.	243,26	286,22	400,99
500	300	BBN001365510110000.	494,63	582,15	815,43	BBN001365320110000.	291,67	343,28	480,93
500	400	BBN001385510110000.	678,43	797,87	1.117,33	BBN001385320110000.	383,57	451,14	631,88
750	250	BBN001347510110000.	442,23	520,16	728,44	BBN001347320110000.	287,68	338,35	473,88
750	300	BBN001367510110000.	539,05	634,28	888,32	BBN001367320110000.	336,09	395,41	553,82
750	400	BBN001387510110000.	722,85	850,00	1.190,22	BBN001387320110000.	427,99	503,27	704,77
900	250	BBN001349510110000.	475,48	559,40	783,23	BBN001349320110000.	320,93	377,59	528,67
900	300	BBN001369510110000.	572,30	673,52	943,11	BBN001369320110000.	369,34	434,65	608,61
900	400	BBN001389510110000.	756,10	889,24	1.245,01	BBN001389320110000.	461,24	542,51	759,56
1000	250	BBN001341510110000.	486,52	572,30	800,92	BBN001341320110000.	331,97	390,49	546,36
1000	300	BBN001361510110000.	583,34	686,42	960,80	BBN001361320110000.	380,38	447,55	626,30
1000	400	BBN001381510110000.	767,14	902,14	1.262,70	BBN001381320110000.	472,28	555,41	777,25

H1220 mm

Module mm	Shelf depth mm	Item no. Freestanding bay	Melamine EUR	Painted EUR	Veneer EUR	Item no. Intermediate bay	Melamine EUR	Painted EUR	Veneer EUR
500	250	BBN001445510110000.	526,15	619,24	867,42	BBN001445320110000.	322,26	379,31	531,33
500	300	BBN001465510110000.	645,85	759,96	1.064,52	BBN001465320110000.	382,11	449,67	629,88
500	400	BBN001485510110000.	884,99	1.041,38	1.458,48	BBN001485320110000.	501,68	590,38	826,86
750	250	BBN001447510110000.	585,73	689,07	964,91	BBN001447320110000.	381,84	449,14	628,82
750	300	BBN001467510110000.	705,43	829,79	1.162,01	BBN001467320110000.	441,69	519,50	727,37
750	400	BBN001487510110000.	944,57	1.111,21	1.555,97	BBN001487320110000.	561,26	660,21	924,35
900	250	BBN001449510110000.	622,31	732,29	1.025,83	BBN001449320110000.	418,42	492,36	689,74
900	300	BBN001469510110000.	742,01	873,01	1.222,93	BBN001469320110000.	478,27	562,72	788,29
900	400	BBN001489510110000.	981,15	1.154,43	1.616,89	BBN001489320110000.	597,84	703,43	985,27
1000	250	BBN001441510110000.	644,52	758,36	1.061,87	BBN001441320110000.	440,63	518,43	725,78
1000	300	BBN001461510110000.	764,22	899,08	1.258,97	BBN001461320110000.	500,48	588,79	824,33
1000	400	BBN001481510110000.	1.003,36	1.180,50	1.652,93	BBN001481320110000.	620,05	729,50	1.021,31

LINGO SHELVING SYSTEM

DOUBLE-SIDED - LOW WOODEN BACK PANEL - ADJUSTABLE FEET - FOR TOP SHELF

Painted and veneered Lingo Shelving Systems are FSC-certified.

H1520 mm

Module mm	Shelf depth mm	Item no. Freestanding bay	Melamine EUR	Painted EUR	Veneer EUR	Item no. Intermediate bay	Melamine EUR	Painted EUR	Veneer EUR
500	250	BBN001545510110000.	600,37	706,23	988,45	BBN001545320110000.	372,67	438,37	613,66
500	300	BBN001565510110000.	700,65	824,33	1.154,71	BBN001565320110000.	422,81	497,42	696,79
500	400	BBN001585510110000.	952,01	1.120,13	1.568,33	BBN001585320110000.	548,49	645,32	903,60
750	250	BBN001547510110000.	672,86	791,61	1.107,75	BBN001547320110000.	445,16	523,75	732,96
750	300	BBN001567510110000.	773,14	909,71	1.274,01	BBN001567320110000.	495,30	582,80	816,09
750	400	BBN001587510110000.	1.024,50	1.205,51	1.687,63	BBN001587320110000.	620,98	730,70	1.022,90
900	250	BBN001549510110000.	721,27	848,54	1.187,82	BBN001549320110000.	493,57	580,68	813,03
900	300	BBN001569510110000.	821,55	966,64	1.354,08	BBN001569320110000.	543,71	639,73	896,16
900	400	BBN001589510110000.	1.072,91	1.262,44	1.767,70	BBN001589320110000.	669,39	787,63	1.102,97
1000	250	BBN001541510110000.	745,74	877,40	1.227,45	BBN001541320110000.	518,04	609,54	852,66
1000	300	BBN001561510110000.	846,02	995,50	1.393,71	BBN001561320110000.	568,18	668,59	935,79
1000	400	BBN001581510110000.	1.097,38	1.291,30	1.807,33	BBN001581320110000.	693,86	816,49	1.142,60

H1820 mm

Module mm	Shelf depth mm	Item no. Freestanding bay	Melamine EUR	Painted EUR	Veneer EUR	Item no. Intermediate bay	Melamine EUR	Painted EUR	Veneer EUR
500	250	BBN001645510110000.	705,31	829,92	1.162,29	BBN001645320110000.	268,53	513,91	719,53
500	300	BBN001665510110000.	824,73	970,64	1.358,33	BBN001665320110000.	496,49	584,27	817,55
500	400	BBN001685510110000.	1.123,19	1.321,48	1.850,43	BBN001685320110000.	645,72	759,69	1.063,60
750	250	BBN001647510110000.	789,23	928,61	1.300,88	BBN001647320110000.	520,70	612,60	858,12
750	300	BBN001667510110000.	908,65	1.069,33	1.496,92	BBN001667320110000.	580,41	682,96	956,14
750	400	BBN001687510110000.	1.207,11	1.420,17	1.989,02	BBN001687320110000.	729,64	858,38	1.202,19
900	250	BBN001649510110000.	850,28	1.000,70	1.401,29	BBN001649320110000.	581,75	684,69	958,53
900	300	BBN001669510110000.	969,70	1.141,42	1.597,33	BBN001669320110000.	641,46	755,05	1.056,55
900	400	BBN001689510110000.	1.268,16	1.492,26	2.089,43	BBN001689320110000.	790,69	930,47	1.302,60
1000	250	BBN001641510110000.	537,06	1.027,43	885,52	BBN001641320110000.	604,62	711,42	996,31
1000	300	BBN001661510110000.	992,57	1.168,15	1.635,11	BBN001661320110000.	664,33	781,78	1.094,33
1000	400	BBN001681510110000.	1.291,03	1.518,99	2.127,21	BBN001681320110000.	813,56	957,20	1.340,38

H2120 mm

Module mm	Shelf depth mm	Item no. Freestanding bay	Melamine EUR	Painted EUR	Veneer EUR	Item no. Intermediate bay	Melamine EUR	Painted EUR	Veneer EUR
500	250	BBN001745510110000.	801,19	942,17	1.319,75	BBN001745320110000.	497,82	585,33	819,94
500	300	BBN001765510110000.	948,29	1.115,61	1.562,09	BBN001765320110000.	571,37	672,05	941,11
500	400	BBN001785510110000.	1.291,71	1.518,85	2.127,07	BBN001785320110000.	743,08	873,67	1.223,60
750	250	BBN001747510110000.	898,01	1.056,55	1.479,22	BBN001747320110000.	594,64	699,71	979,41
750	300	BBN001767510110000.	1.045,11	1.229,99	1.721,56	BBN001767320110000.	668,19	786,43	1.100,58
750	400	BBN001787510110000.	1.388,53	1.633,23	2.286,54	BBN001787320110000.	839,90	988,05	1.383,07
900	250	BBN001749510110000.	968,23	1.139,01	1.595,33	BBN001749320110000.	664,86	782,17	1.095,52
900	300	BBN001769510110000.	1.115,33	1.312,45	1.837,67	BBN001769320110000.	738,41	868,89	1.216,69
900	400	BBN001789510110000.	1.458,75	1.715,69	2.402,65	BBN001789320110000.	910,12	1.070,51	1.499,18
1000	250	BBN001741510110000.	994,97	1.170,54	1.639,22	BBN001741320110000.	691,60	813,70	1.139,41
1000	300	BBN001761510110000.	1.142,07	1.343,98	1.881,56	BBN001761320110000.	765,15	900,42	1.260,58
1000	400	BBN001781510110000.	1.485,49	1.747,22	2.446,54	BBN001781320110000.	936,86	1.102,04	1.543,07

LINGO SHELVING SYSTEM

BBN001 - CROSS BRACE - ADJUSTABLE FEET - FOR TOP SHELF



LINGO SHELVING SYSTEM

BBN001 - CROSS BRACE - ADJUSTABLE FEET - FOR TOP SHELF

Shelving system with wooden panels and cross brace. To be used with top shelf.

Freestanding bay includes 2 outer panels and 1 cross brace.

Intermediate bay includes 1 intermediate panel and 1 cross brace.

Middle shelf must be screwed into panels for bays above H1220 mm.

- Prices based on steel price group 1 and wooden price group A (see Design Options pages 6-9).

- For top shelves, see pages 156 & 174

- For shelves see page 144 & 166.

- For accessories see page 186.

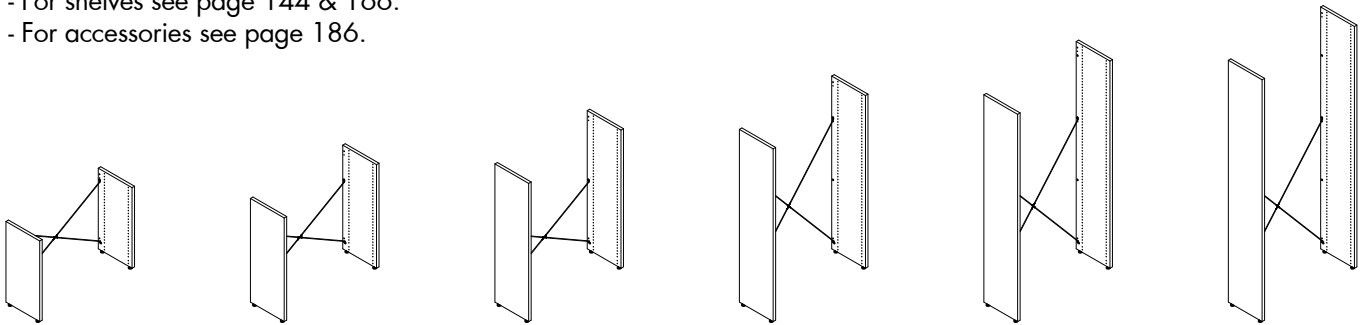

Single-sided freestanding bay - H720/920/1220/1520/1820/2120 mm

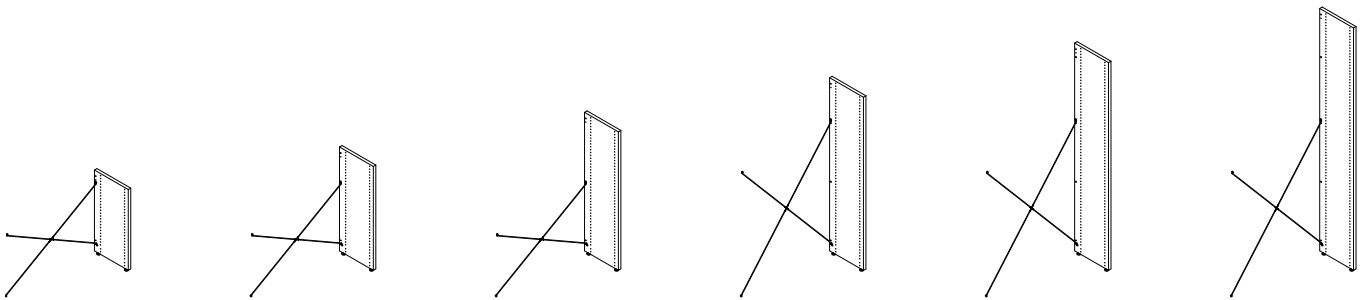

Single-sided intermediate bay - H720/920/1220/1520/1820/2120 mm

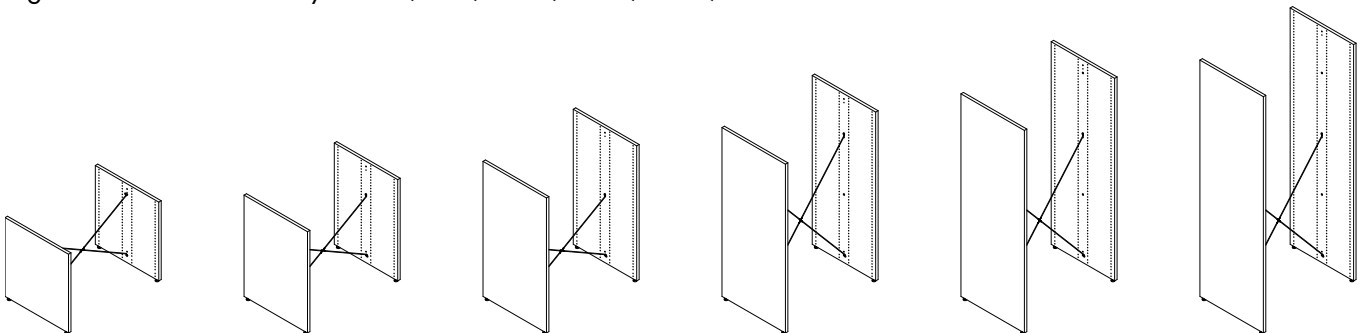

Double-sided freestanding bay - H720/920/1220/1520/1820/2120 mm

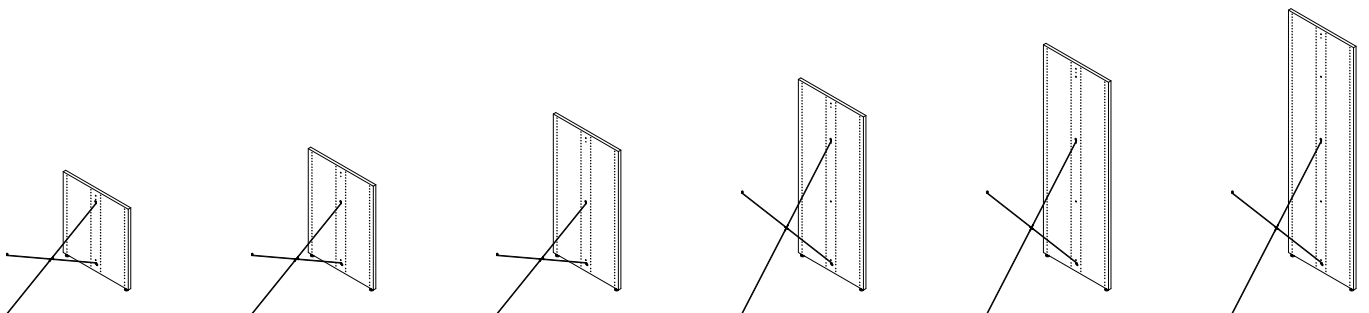

Double-sided intermediate bay - H720/920/1220/1520/1820/2120 mm

LINGO SHELVING SYSTEM

SINGLE-SIDED - CROSS BRACE - ADJUSTABLE FEET - FOR TOP SHELF

Painted and veneered Lingo Shelving Systems are FSC-certified.

H720 mm

Module mm	Shelf depth mm	Item no. Freestanding bay	Melamine EUR	Painted EUR	Veneer EUR	Item no. Intermediate bay	Melamine EUR	Painted EUR	Veneer EUR
500	250	BBN001235510190000.	187,67	217,19	295,39	BBN001235320190000.	104,94	119,70	158,80
500	300	BBN001255510190000.	211,87	245,11	334,77	BBN001255320190000.	117,04	133,66	178,49
500	400	BBN001275510190000.	279,17	324,65	445,69	BBN001275320190000.	150,69	173,43	233,95
750	250	BBN001237510190000.	187,67	217,19	295,39	BBN001237320190000.	104,94	119,70	158,80
750	300	BBN001257510190000.	211,87	245,11	334,77	BBN001257320190000.	117,04	133,66	178,49
750	400	BBN001277510190000.	279,17	324,65	445,69	BBN001277320190000.	150,69	173,43	233,95
900	250	BBN001239510190000.	187,67	217,19	295,39	BBN001239320190000.	104,94	119,70	158,80
900	300	BBN001259510190000.	211,87	245,11	334,77	BBN001259320190000.	117,04	133,66	178,49
900	400	BBN001279510190000.	279,17	324,65	445,69	BBN001279320190000.	150,69	173,43	233,95
1000	250	BBN001231510190000.	187,67	217,19	295,39	BBN001231320190000.	104,94	119,70	158,80
1000	300	BBN001251510190000.	211,87	245,11	334,77	BBN001251320190000.	117,04	133,66	178,49
1000	400	BBN001271510190000.	279,17	324,65	445,69	BBN001271320190000.	150,69	173,43	233,95

H920 mm

Module mm	Shelf depth mm	Item no. Freestanding bay	Melamine EUR	Painted EUR	Veneer EUR	Item no. Intermediate bay	Melamine EUR	Painted EUR	Veneer EUR
500	250	BBN001335510190000.	234,21	271,71	370,93	BBN001335320190000.	128,21	146,96	196,57
500	300	BBN001355510190000.	264,81	307,37	422,01	BBN001355320190000.	143,51	164,79	222,11
500	400	BBN001375510190000.	350,73	408,45	563,25	BBN001375320190000.	186,47	215,33	292,73
750	250	BBN001337510190000.	234,21	271,71	370,93	BBN001337320190000.	128,21	146,96	196,57
750	300	BBN001357510190000.	264,81	307,37	422,01	BBN001357320190000.	143,51	164,79	222,11
750	400	BBN001377510190000.	350,73	408,45	563,25	BBN001377320190000.	186,47	215,33	292,73
900	250	BBN001339510190000.	234,21	271,71	370,93	BBN001339320190000.	128,21	146,96	196,57
900	300	BBN001359510190000.	264,81	307,37	422,01	BBN001359320190000.	143,51	164,79	222,11
900	400	BBN001379510190000.	350,73	408,45	563,25	BBN001379320190000.	186,47	215,33	292,73
1000	250	BBN001331510190000.	234,21	271,71	370,93	BBN001331320190000.	128,21	146,96	196,57
1000	300	BBN001351510190000.	264,81	307,37	422,01	BBN001351320190000.	143,51	164,79	222,11
1000	400	BBN001371510190000.	350,73	408,45	563,25	BBN001371320190000.	186,47	215,33	292,73

H1220 mm

Module mm	Shelf depth mm	Item no. Freestanding bay	Melamine EUR	Painted EUR	Veneer EUR	Item no. Intermediate bay	Melamine EUR	Painted EUR	Veneer EUR
500	250	BBN001435510190000.	302,85	352,05	484,51	BBN001435320190000.	162,53	187,13	253,36
500	300	BBN001455510190000.	315,07	366,69	504,21	BBN001455320190000.	168,64	194,45	263,21
500	400	BBN001475510190000.	447,01	522,03	721,79	BBN001475320190000.	234,61	272,12	372,00
750	250	BBN001437510190000.	302,85	352,05	484,51	BBN001437320190000.	162,53	187,13	253,36
750	300	BBN001457510190000.	315,07	366,69	504,21	BBN001457320190000.	168,64	194,45	263,21
750	400	BBN001477510190000.	447,01	522,03	721,79	BBN001477320190000.	234,61	272,12	372,00
900	250	BBN001439510190000.	302,85	352,05	484,51	BBN001439320190000.	162,53	187,13	253,36
900	300	BBN001459510190000.	315,07	366,69	504,21	BBN001459320190000.	168,64	194,45	263,21
900	400	BBN001479510190000.	447,01	522,03	721,79	BBN001479320190000.	234,61	272,12	372,00
1000	250	BBN001431510190000.	302,85	352,05	484,51	BBN001431320190000.	162,53	187,13	253,36
1000	300	BBN001451510190000.	315,07	366,69	504,21	BBN001451320190000.	168,64	194,45	263,21
1000	400	BBN001471510190000.	447,01	522,03	721,79	BBN001471320190000.	234,61	272,12	372,00

LINGO SHELVING SYSTEM

SINGLE-SIDED - CROSS BRACE - ADJUSTABLE FEET - FOR TOP SHELF

Painted and veneered Lingo Shelving Systems are FSC-certified.

H1520 mm

Module mm	Shelf depth mm	Item no. Freestanding bay	Melamine EUR	Painted EUR	Veneer EUR	Item no. Intermediate bay	Melamine EUR	Painted EUR	Veneer EUR
500	250	BBN001535510190000.	341,15	397,53	547,57	BBN001535320190000.	181,68	209,87	284,89
500	300	BBN001555510190000.	353,11	411,91	566,97	BBN001555320190000.	187,66	217,06	294,59
500	400	BBN001575510190000.	511,91	598,37	828,19	BBN001575320190000.	267,06	310,29	425,20
750	250	BBN001537510190000.	341,15	397,53	547,57	BBN001537320190000.	181,68	209,87	284,89
750	300	BBN001557510190000.	353,11	411,91	566,97	BBN001557320190000.	187,66	217,06	294,59
750	400	BBN001577510190000.	511,91	598,37	828,19	BBN001577320190000.	267,06	310,29	425,20
900	250	BBN001539510190000.	341,15	397,53	547,57	BBN001539320190000.	181,68	209,87	284,89
900	300	BBN001559510190000.	353,11	411,91	566,97	BBN001559320190000.	187,66	217,06	294,59
900	400	BBN001579510190000.	511,91	598,37	828,19	BBN001579320190000.	267,06	310,29	425,20
1000	250	BBN001531510190000.	341,15	397,53	547,57	BBN001531320190000.	181,68	209,87	284,89
1000	300	BBN001551510190000.	353,11	411,91	566,97	BBN001551320190000.	187,66	217,06	294,59
1000	400	BBN001571510190000.	511,91	598,37	828,19	BBN001571320190000.	267,06	310,29	425,20

H1820 mm

Module mm	Shelf depth mm	Item no. Freestanding bay	Melamine EUR	Painted EUR	Veneer EUR	Item no. Intermediate bay	Melamine EUR	Painted EUR	Veneer EUR
500	250	BBN001635510190000.	396,21	462,17	638,27	BBN001635320190000.	209,21	242,19	330,24
500	300	BBN001655510190000.	404,99	472,55	652,09	BBN001655320190000.	213,60	247,38	337,15
500	400	BBN001675510190000.	582,41	681,35	945,49	BBN001675320190000.	302,31	351,78	483,85
750	250	BBN001637510190000.	396,21	462,17	638,27	BBN001637320190000.	209,21	242,19	330,24
750	300	BBN001657510190000.	404,99	472,55	652,09	BBN001657320190000.	213,60	247,38	337,15
750	400	BBN001677510190000.	582,41	681,35	945,49	BBN001677320190000.	302,31	351,78	483,85
900	250	BBN001639510190000.	396,21	462,17	638,27	BBN001639320190000.	209,21	242,19	330,24
900	300	BBN001659510190000.	404,99	472,55	652,09	BBN001659320190000.	213,60	247,38	337,15
900	400	BBN001679510190000.	582,41	681,35	945,49	BBN001679320190000.	302,31	351,78	483,85
1000	250	BBN001631510190000.	396,21	462,17	638,27	BBN001631320190000.	209,21	242,19	330,24
1000	300	BBN001651510190000.	404,99	472,55	652,09	BBN001651320190000.	213,60	247,38	337,15
1000	400	BBN001671510190000.	582,41	681,35	945,49	BBN001671320190000.	302,31	351,78	483,85

H2120 mm

Module mm	Shelf depth mm	Item no. Freestanding bay	Melamine EUR	Painted EUR	Veneer EUR	Item no. Intermediate bay	Melamine EUR	Painted EUR	Veneer EUR
500	250	BBN001735510190000.	439,03	512,71	709,03	BBN001735320190000.	230,62	267,46	365,62
500	300	BBN001755510190000.	447,01	522,03	721,79	BBN001755320190000.	234,61	272,12	372,00
500	400	BBN001775510190000.	636,93	745,47	1.034,35	BBN001775320190000.	329,57	383,84	528,28
750	250	BBN001737510190000.	439,03	512,71	709,03	BBN001737320190000.	230,62	267,46	365,62
750	300	BBN001757510190000.	447,01	522,03	721,79	BBN001757320190000.	234,61	272,12	372,00
750	400	BBN001777510190000.	636,93	745,47	1.034,35	BBN001777320190000.	329,57	383,84	528,28
900	250	BBN001739510190000.	439,03	512,71	709,03	BBN001739320190000.	230,62	267,46	365,62
900	300	BBN001759510190000.	447,01	522,03	721,79	BBN001759320190000.	234,61	272,12	372,00
900	400	BBN001779510190000.	636,93	745,47	1.034,35	BBN001779320190000.	329,57	383,84	528,28
1000	250	BBN001731510190000.	439,03	512,71	709,03	BBN001731320190000.	230,62	267,46	365,62
1000	300	BBN001751510190000.	447,01	522,03	721,79	BBN001751320190000.	234,61	272,12	372,00
1000	400	BBN001771510190000.	636,93	745,47	1.034,35	BBN001771320190000.	329,57	383,84	528,28

LINGO SHELVING SYSTEM

DOUBLE-SIDED - CROSS BRACE - ADJUSTABLE FEET - FOR TOP SHELF

Painted and veneered Lingo Shelving Systems are FSC-certified.

H720 mm

Module mm	Shelf depth mm	Item no. Freestanding bay	Melamine EUR	Painted EUR	Veneer EUR	Item no. Intermediate bay	Melamine EUR	Painted EUR	Veneer EUR
500	250	BBN001245510190000.	264,27	306,83	420,67	BBN001245320190000.	143,24	164,52	221,44
500	300	BBN001265510190000.	339,81	395,67	569,37	BBN001265320190000.	181,01	208,94	283,82
500	400	BBN001285510190000.	483,73	565,11	782,43	BBN001285320190000.	252,97	293,66	402,32
750	250	BBN001247510190000.	264,27	306,83	420,67	BBN001247320190000.	143,24	164,52	221,44
750	300	BBN001267510190000.	339,81	395,67	569,37	BBN001267320190000.	181,01	208,94	283,82
750	400	BBN001287510190000.	483,73	565,11	782,43	BBN001287320190000.	252,97	293,66	402,32
900	250	BBN001249510190000.	264,27	306,83	420,67	BBN001249320190000.	143,24	164,52	221,44
900	300	BBN001269510190000.	339,81	395,67	569,37	BBN001269320190000.	181,01	208,94	283,82
900	400	BBN001289510190000.	483,73	565,11	782,43	BBN001289320190000.	252,97	293,66	402,32
1000	250	BBN001241510190000.	264,27	306,83	420,67	BBN001241320190000.	143,24	164,52	221,44
1000	300	BBN001261510190000.	339,81	395,67	569,37	BBN001261320190000.	181,01	208,94	283,82
1000	400	BBN001281510190000.	483,73	565,11	782,43	BBN001281320190000.	252,97	293,66	402,32

H920 mm

Module mm	Shelf depth mm	Item no. Freestanding bay	Melamine EUR	Painted EUR	Veneer EUR	Item no. Intermediate bay	Melamine EUR	Painted EUR	Veneer EUR
500	250	BBN001345510190000.	331,31	385,83	531,33	BBN001345320190000.	176,76	204,02	276,77
500	300	BBN001365510190000.	428,13	499,95	691,21	BBN001365320190000.	225,17	261,08	356,71
500	400	BBN001385510190000.	611,93	715,67	993,11	BBN001385320190000.	317,07	368,94	507,66
750	250	BBN001347510190000.	331,31	385,83	531,33	BBN001347320190000.	176,76	204,02	276,77
750	300	BBN001367510190000.	428,13	499,95	691,21	BBN001367320190000.	225,17	261,08	356,71
750	400	BBN001387510190000.	611,93	715,67	993,11	BBN001387320190000.	317,07	368,94	507,66
900	250	BBN001349510190000.	331,31	385,83	531,33	BBN001349320190000.	176,76	204,02	276,77
900	300	BBN001369510190000.	428,13	499,95	691,21	BBN001369320190000.	225,17	261,08	356,71
900	400	BBN001389510190000.	611,93	715,67	993,11	BBN001389320190000.	317,07	368,94	507,66
1000	250	BBN001341510190000.	331,31	385,83	531,33	BBN001341320190000.	176,76	204,02	276,77
1000	300	BBN001361510190000.	428,13	499,95	691,21	BBN001361320190000.	225,17	261,08	356,71
1000	400	BBN001381510190000.	611,93	715,67	993,11	BBN001381320190000.	317,07	368,94	507,66

H1220 mm

Module mm	Shelf depth mm	Item no. Freestanding bay	Melamine EUR	Painted EUR	Veneer EUR	Item no. Intermediate bay	Melamine EUR	Painted EUR	Veneer EUR
500	250	BBN001445510190000.	429,99	502,07	694,39	BBN001445320190000.	226,10	262,14	358,30
500	300	BBN001465510190000.	549,69	642,79	891,49	BBN001465320190000.	285,95	332,50	456,85
500	400	BBN001485510190000.	788,83	924,21	1.285,45	BBN001485320190000.	405,52	473,21	653,83
750	250	BBN001447510190000.	429,99	502,07	694,39	BBN001447320190000.	226,10	262,14	358,30
750	300	BBN001467510190000.	549,69	642,79	891,49	BBN001467320190000.	285,95	332,50	456,85
750	400	BBN001487510190000.	788,83	924,21	1.285,45	BBN001487320190000.	405,52	473,21	653,83
900	250	BBN001449510190000.	429,99	502,07	694,39	BBN001449320190000.	226,10	262,14	358,30
900	300	BBN001469510190000.	549,69	642,79	891,49	BBN001469320190000.	285,95	332,50	456,85
900	400	BBN001489510190000.	788,83	924,21	1.285,45	BBN001489320190000.	405,52	473,21	653,83
1000	250	BBN001441510190000.	429,99	502,07	694,39	BBN001441320190000.	226,10	262,14	358,30
1000	300	BBN001461510190000.	549,69	642,79	891,49	BBN001461320190000.	285,95	332,50	456,85
1000	400	BBN001481510190000.	788,83	924,21	1.285,45	BBN001481320190000.	405,52	473,21	653,83

LINGO SHELVING SYSTEM

DOUBLE-SIDED - CROSS BRACE - ADJUSTABLE FEET - FOR TOP SHELF

Painted and veneered Lingo Shelving Systems are FSC-certified.

H1520 mm

Module mm	Shelf depth mm	Item no. Freestanding bay	Melamine EUR	Painted EUR	Veneer EUR	Item no. Intermediate bay	Melamine EUR	Painted EUR	Veneer EUR
500	250	BBN001545510190000.	477,61	557,93	771,79	BBN001545320190000.	249,91	290,07	397,00
500	300	BBN001565510190000.	577,89	676,03	938,05	BBN001565320190000.	300,05	349,12	480,13
500	400	BBN001585510190000.	829,25	971,83	1.351,67	BBN001585320190000.	425,73	497,02	686,94
750	250	BBN001547510190000.	477,61	557,93	771,79	BBN001547320190000.	249,91	290,07	397,00
750	300	BBN001567510190000.	577,89	676,03	938,05	BBN001567320190000.	300,05	349,12	480,13
750	400	BBN001587510190000.	829,25	971,83	1.351,67	BBN001587320190000.	425,73	497,02	686,94
900	250	BBN001549510190000.	477,61	557,93	771,79	BBN001549320190000.	249,91	290,07	397,00
900	300	BBN001569510190000.	577,89	676,03	938,05	BBN001569320190000.	300,05	349,12	480,13
900	400	BBN001589510190000.	829,25	971,83	1.351,67	BBN001589320190000.	425,73	497,02	686,94
1000	250	BBN001541510190000.	477,61	557,93	771,79	BBN001541320190000.	249,91	290,07	397,00
1000	300	BBN001561510190000.	577,89	676,03	938,05	BBN001561320190000.	300,05	349,12	480,13
1000	400	BBN001581510190000.	829,25	971,83	1.351,67	BBN001581320190000.	425,73	497,02	686,94

H1820 mm

Module mm	Shelf depth mm	Item no. Freestanding bay	Melamine EUR	Painted EUR	Veneer EUR	Item no. Intermediate bay	Melamine EUR	Painted EUR	Veneer EUR
500	250	BBN001645510190000.	559,27	654,23	907,73	BBN001645320190000.	290,74	338,22	464,97
500	300	BBN001665510190000.	678,69	794,95	1.103,77	BBN001665320190000.	350,45	408,58	562,99
500	400	BBN001685510190000.	977,15	1.145,79	1.595,87	BBN001685320190000.	499,68	584,00	809,04
750	250	BBN001647510190000.	559,27	654,23	907,73	BBN001647320190000.	290,74	338,22	464,97
750	300	BBN001667510190000.	678,69	794,95	1.103,77	BBN001667320190000.	350,45	408,58	562,99
750	400	BBN001687510190000.	977,15	1.145,79	1.595,87	BBN001687320190000.	499,68	584,00	809,04
900	250	BBN001649510190000.	559,27	654,23	907,73	BBN001649320190000.	290,74	338,22	464,97
900	300	BBN001669510190000.	678,69	794,95	1.103,77	BBN001669320190000.	350,45	408,58	562,99
900	400	BBN001689510190000.	977,15	1.145,79	1.595,87	BBN001689320190000.	499,68	584,00	809,04
1000	250	BBN001641510190000.	559,27	654,23	907,73	BBN001641320190000.	290,74	338,22	464,97
1000	300	BBN001661510190000.	678,69	794,95	1.103,77	BBN001661320190000.	350,45	408,58	562,99
1000	400	BBN001681510190000.	977,15	1.145,79	1.595,87	BBN001681320190000.	499,68	584,00	809,04

H2120 mm

Module mm	Shelf depth mm	Item no. Freestanding bay	Melamine EUR	Painted EUR	Veneer EUR	Item no. Intermediate bay	Melamine EUR	Painted EUR	Veneer EUR
500	250	BBN001745510190000.	628,95	735,89	1.021,83	BBN001745320190000.	325,58	379,05	522,02
500	300	BBN001765510190000.	776,05	909,33	1.264,17	BBN001765320190000.	399,13	465,77	643,19
500	400	BBN001785510190000.	1.119,47	1.312,57	1.829,15	BBN001785320190000.	570,84	667,39	925,68
750	250	BBN001747510190000.	628,95	735,89	1.021,83	BBN001747320190000.	325,58	379,05	522,02
750	300	BBN001767510190000.	776,05	909,33	1.264,17	BBN001767320190000.	399,13	465,77	643,19
750	400	BBN001787510190000.	1.119,47	1.312,57	1.829,15	BBN001787320190000.	570,84	667,39	925,68
900	250	BBN001749510190000.	628,95	735,89	1.021,83	BBN001749320190000.	325,58	379,05	522,02
900	300	BBN001769510190000.	776,05	909,33	1.264,17	BBN001769320190000.	399,13	465,77	643,19
900	400	BBN001789510190000.	1.119,47	1.312,57	1.829,15	BBN001789320190000.	570,84	667,39	925,68
1000	250	BBN001741510190000.	628,95	735,89	1.021,83	BBN001741320190000.	325,58	379,05	522,02
1000	300	BBN001761510190000.	776,05	909,33	1.264,17	BBN001761320190000.	399,13	465,77	643,19
1000	400	BBN001781510190000.	1.119,47	1.312,57	1.829,15	BBN001781320190000.	570,84	667,39	925,68

LINGO SHELVING SYSTEM

BBN002 - STEEL BACK FRAME - ADJUSTABLE FEET - WITH OVERLAYING WOODEN TOP PLATE



LINGO SHELVING SYSTEM

BBN002 - STEEL BACK FRAME - ADJUSTABLE FEET - WITH OVERLAYING WOODEN TOP PLATE

Shelving system with wooden panels, steel back frame and overlaying top plate.
For configurations with more than 3 bays, please contact Customer Service.

- Prices based on steel price group 1 and wooden price group A (see Design Options pages 6-9).
- For shelves see page 144 & 166.
- For accessories see page 186.

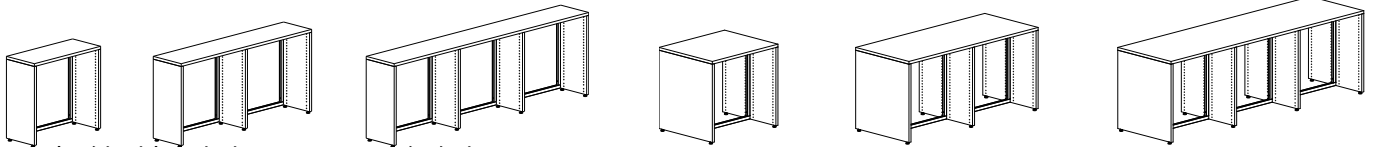

Single-/double-sided H720 mm - 1/2/3 bays

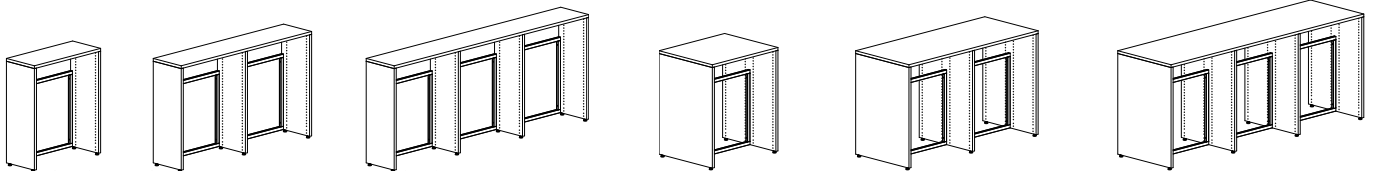

Single-/double-sided H920 mm - 1/2/3 bays

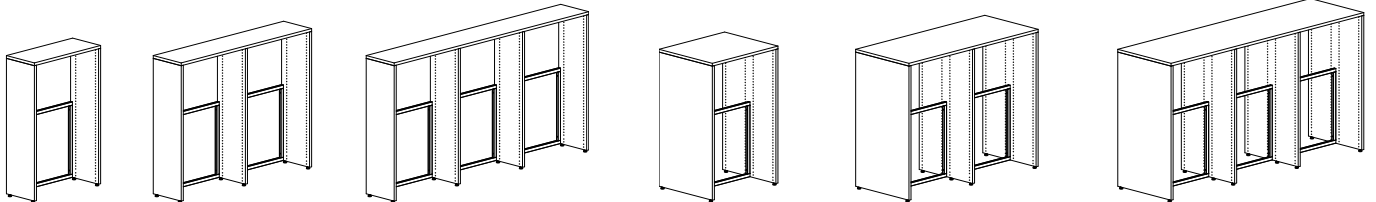

Single-/double-sided H1220 mm - 1/2/3 bays

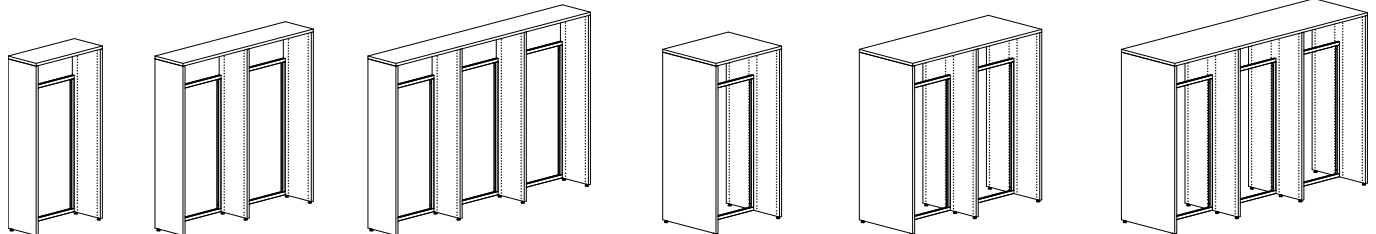

Single-/double-sided H1520 mm - 1/2/3 bays

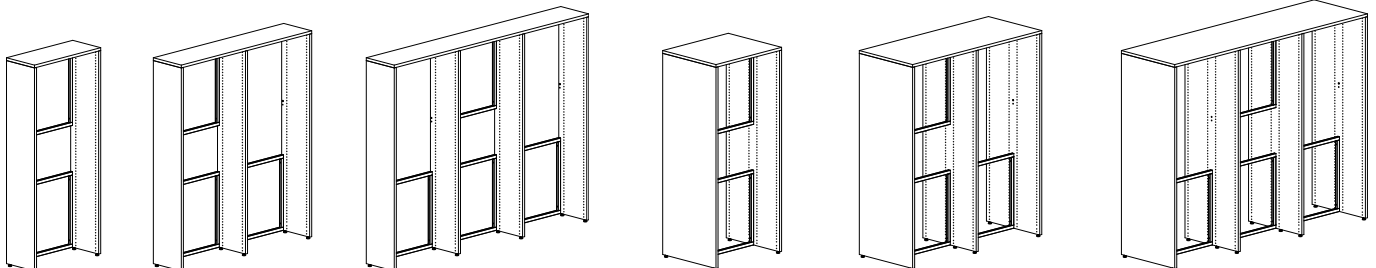

Single-/double-sided H1820 mm - 1/2/3 bays

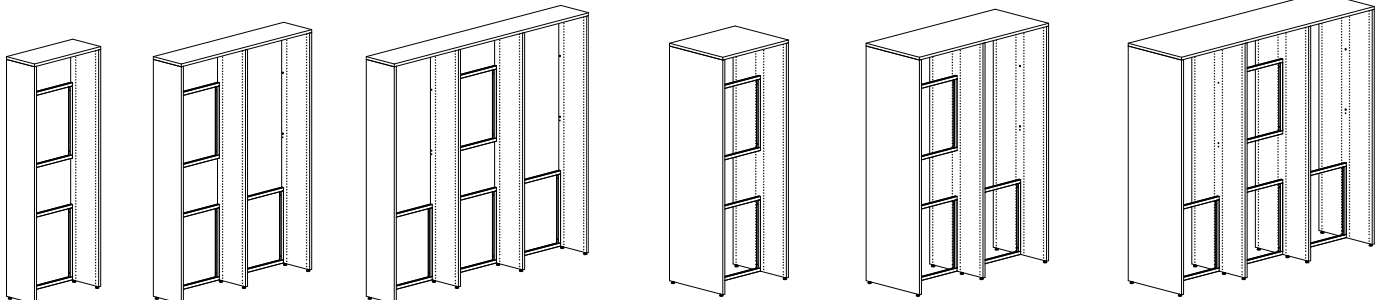

Single-/double-sided H2120 mm - 1/2/3 bays

LINGO SHELVING SYSTEM

SINGLE-SIDED - STEEL BACK FRAME - ADJUSTABLE FEET - WITH OVERLAYING WOODEN TOP PLATE

Painted and veneered Lingo Shelving Systems are FSC-certified. Configurations with more than 2/3 bays are available.

H720 mm

Module mm	Shelf depth mm	Bays	Item no.	Melamine EUR	Painted EUR	Veneer EUR
500	250	1	BBN00223551016000.	315	356,31	467,22
500	250	2	BBN00223551026000.	533	599,03	775,12
500	250	3	BBN00223551036000.	758	849,73	1.094,18
500	300	1	BBN00225551016000.	346	393,27	519,11
500	300	2	BBN00225551026000.	583	657,27	856,53
500	300	3	BBN00225551036000.	827	930,04	1.206,85
500	400	1	BBN00227551016000.	422	481,85	642,93
500	400	2	BBN00227551026000.	698	792,54	1.045,65
500	400	3	BBN00227551036000.	982	1.113,33	1.462,87
750	250	1	BBN00223751016000.	349	397,14	524,15
750	250	2	BBN00223751026000.	595	672,18	877,26
750	250	3	BBN00223751036000.	851	959,46	1.247,79
750	300	1	BBN00225751016000.	385	438,76	582,68
750	300	2	BBN00225751026000.	652	738,40	970,64
750	300	3	BBN00225751036000.	931	1.052,01	1.378,02
750	400	1	BBN00227751016000.	464	531,73	712,49
750	400	2	BBN00227751026000.	774	882,18	1.171,07
750	400	3	BBN00227751036000.	1.096	1.247,79	1.651,20
900	250	1	BBN00223951016000.	349	397,14	524,15
900	250	2	BBN00223951026000.	595	672,18	877,26
900	300	1	BBN00225951016000.	385	438,76	582,68
900	300	2	BBN00225951026000.	652	738,40	970,64
900	400	1	BBN00227951016000.	464	531,73	712,49
900	400	2	BBN00227951026000.	774	882,18	1.171,07
1000	250	1	BBN00223151016000.	371	421,48	553,94
1000	250	2	BBN00223151026000.	637	717,80	932,85
1000	300	1	BBN00225151016000.	409	464,43	614,33
1000	300	2	BBN00225151026000.	696	786,94	1.030,09
1000	400	1	BBN00227151016000.	489	558,86	746,53
1000	400	2	BBN00227151026000.	820	933,52	1.234,11

LINGO SHELVING SYSTEM

SINGLE-SIDED - STEEL BACK FRAME - ADJUSTABLE FEET - WITH OVERLAYING WOODEN TOP PLATE

Painted and veneered Lingo Shelving Systems are FSC-certified. Configurations with more than 2/3 bays are available.

H920 mm

Module mm	Shelf depth mm	Bays	Item no.	Melamine EUR	Painted EUR	Veneer EUR
500	250	1	BBN00233551016000.	361	410,83	542,76
500	250	2	BBN00233551026000.	602	680,81	888,43
500	250	3	BBN00233551036000.	851	958,77	1.245,26
500	300	1	BBN00235551016000.	399	455,53	606,35
500	300	2	BBN00235551026000.	662	750,66	987,39
500	300	3	BBN00235551036000.	933	1.054,56	1.381,33
500	400	1	BBN00237551016000.	493	565,65	760,49
500	400	2	BBN00237551026000.	805	918,24	1.221,99
500	400	3	BBN00237551036000.	1.125	1.280,93	1.697,99
750	250	1	BBN00233751016000.	396	451,66	599,69
750	250	2	BBN00233751026000.	665	753,96	990,57
750	250	3	BBN00233751036000.	944	1.068,50	1.398,87
750	300	1	BBN00235751016000.	438	501,02	669,92
750	300	2	BBN00235751026000.	731	831,79	1.101,50
750	300	3	BBN00235751036000.	1.036	1.176,53	1.552,50
750	400	1	BBN00237751016000.	535	615,53	830,05
750	400	2	BBN00237751026000.	881	1.007,88	1.347,41
750	400	3	BBN00237751036000.	1.239	1.415,39	1.886,32
900	250	1	BBN00233951016000.	396	451,66	599,69
900	250	2	BBN00233951026000.	665	753,96	990,57
900	300	1	BBN00235951016000.	438	501,02	669,92
900	300	2	BBN00235951026000.	731	831,79	1.101,50
900	400	1	BBN00237951016000.	535	615,53	830,05
900	400	2	BBN00237951026000.	881	1.007,88	1.347,41
1000	250	1	BBN00233151016000.	418	476,00	629,48
1000	250	2	BBN00233151026000.	707	799,58	1.046,16
1000	300	1	BBN00235151016000.	462	526,69	701,57
1000	300	2	BBN00235151026000.	776	880,33	1.160,95
1000	400	1	BBN00237151016000.	560	642,66	864,09
1000	400	2	BBN00237151026000.	928	1.059,22	1.410,45

LINGO SHELVING SYSTEM

SINGLE-SIDED - STEEL BACK FRAME - ADJUSTABLE FEET - WITH OVERLAYING WOODEN TOP PLATE

Painted and veneered Lingo Shelving Systems are FSC-certified. Configurations with more than 2/3 bays are available.

H1220 mm

Module mm	Shelf depth mm	No. of bays	Item no.	Melamine EUR	Painted EUR	Veneer EUR
500	250	1	BBN00243551016000.	430	491,17	656,34
500	250	2	BBN00243551026000.	705	801,32	1.058,80
500	250	3	BBN00243551036000.	988	1.119,45	1.472,42
500	300	1	BBN00245551016000.	450	514,85	688,55
500	300	2	BBN00245551026000.	738	839,64	1.110,69
500	300	3	BBN00245551036000.	1.033	1.173,20	1.545,73
500	400	1	BBN00247551016000.	590	679,23	919,03
500	400	2	BBN00247551026000.	949	1.088,61	1.459,80
500	400	3	BBN00247551036000.	1.318	1.508,09	2.015,07
750	250	1	BBN00243751016000.	464	532,00	713,27
750	250	2	BBN00243751026000.	768	874,47	1.160,94
750	250	3	BBN00243751036000.	1.081	1.229,18	1.626,03
750	300	1	BBN00245751016000.	488	560,34	752,12
750	300	2	BBN00245751026000.	807	920,77	1.224,80
750	300	3	BBN00245751036000.	1.137	1.295,17	1.716,90
750	400	1	BBN00247751016000.	632	729,11	988,59
750	400	2	BBN00247751026000.	1.025	1.178,25	1.585,22
750	400	3	BBN00247751036000.	1.432	1.642,55	2.203,40
900	250	1	BBN00243951016000.	464	532,00	713,27
900	250	2	BBN00243951026000.	768	874,47	1.160,94
900	300	1	BBN00245951016000.	488	560,34	752,12
900	300	2	BBN00245951026000.	807	920,77	1.224,80
900	400	1	BBN00247951016000.	632	729,11	988,59
900	400	2	BBN00247951026000.	1.025	1.178,25	1.585,22
1000	250	1	BBN00243151016000.	487	556,34	743,06
1000	250	2	BBN00243151026000.	810	920,09	1.216,53
1000	300	1	BBN00245151016000.	512	586,01	783,77
1000	300	2	BBN00245151026000.	851	969,31	1.284,25
1000	400	1	BBN00247151016000.	656	756,24	1.022,63
1000	400	2	BBN00247151026000.	1.072	1.229,59	1.648,26

LINGO SHELVING SYSTEM

SINGLE-SIDED - STEEL BACK FRAME - ADJUSTABLE FEET - WITH OVERLAYING WOODEN TOP PLATE

Painted and veneered Lingo Shelving Systems are FSC-certified. Configurations with more than 2/3 bays are available.

H1520 mm

Module mm	Shelf depth mm	No. of bays	Item no.	Melamine EUR	Painted EUR	Veneer EUR
500	250	1	BBN00253551016000.	492	560,59	743,34
500	250	2	BBN00253551026000.	811	917,42	1.201,27
500	250	3	BBN00253551036000.	1.136	1.282,23	1.670,36
500	300	1	BBN00255551016000.	512	584,01	775,25
500	300	2	BBN00255551026000.	843	955,35	1.252,71
500	300	3	BBN00255551036000.	1.181	1.335,46	1.743,07
500	400	1	BBN00257551016000.	678	779,51	1.049,37
500	400	2	BBN00257551026000.	1.095	1.251,00	1.667,28
500	400	3	BBN00257551036000.	1.519	1.732,59	2.299,69
750	250	1	BBN00253751016000.	527	601,42	800,27
750	250	2	BBN00253751026000.	873	990,57	1.303,41
750	250	3	BBN00253751036000.	1.230	1.391,96	1.823,97
750	300	1	BBN00255751016000.	550	629,50	838,82
750	300	2	BBN00255751026000.	912	1.036,48	1.366,82
750	300	3	BBN00255751036000.	1.285	1.457,43	1.914,24
750	400	1	BBN00257751016000.	721	829,39	1.118,93
750	400	2	BBN00257751026000.	1.171	1.340,64	1.792,70
750	400	3	BBN00257751036000.	1.633	1.867,05	2.488,02
900	250	1	BBN00253951016000.	527	601,42	800,27
900	250	2	BBN00253951026000.	873	990,57	1.303,41
900	300	1	BBN00255951016000.	550	629,50	838,82
900	300	2	BBN00255951026000.	912	1.036,48	1.366,82
900	400	1	BBN00257951016000.	721	829,39	1.118,93
900	400	2	BBN00257951026000.	1.171	1.340,64	1.792,70
1000	250	1	BBN00253151016000.	552	628,69	832,99
1000	250	2	BBN00253151026000.	921	1.042,05	1.364,86
1000	300	1	BBN00255151016000.	577	658,10	873,40
1000	300	2	BBN00255151026000.	962	1.090,88	1.432,13
1000	400	1	BBN00257151016000.	748	859,45	1.155,90
1000	400	2	BBN00257151026000.	1.223	1.397,84	1.861,60

LINGO SHELVING SYSTEM

SINGLE-SIDED - STEEL BACK FRAME - ADJUSTABLE FEET - WITH OVERLAYING WOODEN TOP PLATE

Painted and veneered Lingo Shelving Systems are FSC-certified. Configurations with more than 2/3 bays are available.

H1820 mm

Module mm	Shelf depth mm	Bays	Item no.	Melamine EUR	Painted EUR	Veneer EUR
500	250	1	BBN00263551016000.	523	601,29	810,10
500	250	2	BBN00263551026000.	845	966,50	1.289,44
500	250	3	BBN00263551036000.	1.175	1.339,69	1.779,94
500	300	1	BBN00265551016000.	539	620,71	836,43
500	300	2	BBN00265551026000.	872	998,43	1.332,51
500	300	3	BBN00265551036000.	1.213	1.384,92	1.841,49
500	400	1	BBN00267551016000.	725	838,55	1.142,73
500	400	2	BBN00267551026000.	1.152	1.327,59	1.795,35
500	400	3	BBN00267551036000.	1.589	1.826,73	2.462,47
750	250	1	BBN00263751016000.	558	642,12	867,03
750	250	2	BBN00263751026000.	908	1.039,65	1.391,58
750	250	3	BBN00263751036000.	1.268	1.449,42	1.933,55
750	300	1	BBN00265751016000.	578	666,20	900,00
750	300	2	BBN00265751026000.	942	1.079,56	1.446,62
750	300	3	BBN00265751036000.	1.317	1.506,89	2.012,66
750	400	1	BBN00267751016000.	767	888,43	1.212,29
750	400	2	BBN00267751026000.	1.229	1.417,23	1.920,77
750	400	3	BBN00267751036000.	1.703	1.961,19	2.650,80
900	250	1	BBN00263951016000.	558	642,12	867,03
900	250	2	BBN00263951026000.	908	1.039,65	1.391,58
900	300	1	BBN00265951016000.	578	666,20	900,00
900	300	2	BBN00265951026000.	942	1.079,56	1.446,62
900	400	1	BBN00267951016000.	767	888,43	1.212,29
900	400	2	BBN00267951026000.	1.229	1.417,23	1.920,77
1000	250	1	BBN00263151016000.	580	666,46	896,82
1000	250	2	BBN00263151026000.	950	1.085,27	1.447,17
1000	300	1	BBN00265151016000.	602	691,87	931,65
1000	300	2	BBN00265151026000.	986	1.128,10	1.506,07
1000	400	1	BBN00267151016000.	792	915,56	1.246,33
1000	400	2	BBN00267151026000.	1.275	1.468,57	1.983,81

LINGO SHELVING SYSTEM

SINGLE-SIDED - STEEL BACK FRAME - ADJUSTABLE FEET - WITH OVERLAYING WOODEN TOP PLATE

Painted and veneered Lingo Shelving Systems are FSC-certified. Configurations with more than 2/3 bays are available.

H2120 mm

Module mm	Shelf depth mm	Bays	Item no.	Melamine EUR	Painted EUR	Veneer EUR
500	250	1	BBN00273551016000.	566	651,83	880,86
500	250	2	BBN00273551026000.	910	1.042,31	1.395,58
500	250	3	BBN00273551036000.	1.260	1.440,77	1.921,46
500	300	1	BBN00275551016000.	581	670,19	906,13
500	300	2	BBN00275551026000.	936	1.072,65	1.437,06
500	300	3	BBN00275551036000.	1.297	1.483,88	1.980,89
500	400	1	BBN00277551016000.	780	902,67	1.231,59
500	400	2	BBN00277551026000.	1.234	1.423,77	1.928,64
500	400	3	BBN00277551036000.	1.698	1.954,97	2.640,19
750	250	1	BBN00273751016000.	601	692,66	937,79
750	250	2	BBN00273751026000.	972	1.115,46	1.497,72
750	250	3	BBN00273751036000.	1.354	1.550,50	2.075,07
750	300	1	BBN00275751016000.	620	715,68	969,70
750	300	2	BBN00275751026000.	1.005	1.153,78	1.551,17
750	300	3	BBN00275751036000.	1.401	1.605,85	2.152,06
750	400	1	BBN00277751016000.	822	952,55	1.301,15
750	400	2	BBN00277751026000.	1.310	1.513,41	2.054,06
750	400	3	BBN00277751036000.	1.812	2.089,43	2.828,52
900	250	1	BBN00273951016000.	601	692,66	937,79
900	250	2	BBN00273951026000.	972	1.115,46	1.497,72
900	300	1	BBN00275951016000.	620	715,68	969,70
900	300	2	BBN00275951026000.	1.005	1.153,78	1.551,17
900	400	1	BBN00277951016000.	822	952,55	1.301,15
900	400	2	BBN00277951026000.	1.310	1.513,41	2.054,06
1000	250	1	BBN00273151016000.	623	717,00	967,58
1000	250	2	BBN00273151026000.	1.014	1.161,08	1.553,31
1000	300	1	BBN00275151016000.	644	741,35	1.001,35
1000	300	2	BBN00275151026000.	1.049	1.202,32	1.610,62
1000	400	1	BBN00277151016000.	846	979,68	1.335,19
1000	400	2	BBN00277151026000.	1.357	1.564,75	2.117,10

LINGO SHELVING SYSTEM

DOUBLE-SIDED - STEEL BACK FRAME - ADJUSTABLE FEET - WITH OVERLAYING WOODEN TOP PLATE

Painted and veneered Lingo Shelving Systems are FSC-certified. Configurations with more than 2/3 bays are available.

H720 mm

Module mm	Shelf depth mm	No. of bays	Item no.	Melamine EUR	Painted EUR	Veneer EUR
500	250	1	BBN00224551016000.	429	489,97	653,68
500	250	2	BBN00224551026000.	715	812,23	1.073,03
500	250	3	BBN00224551036000.	1.012	1.147,38	1.510,59
500	300	1	BBN00226551016000.	516	592,64	798,00
500	300	2	BBN00226551026000.	849	970,49	1.295,28
500	300	3	BBN00226551036000.	1.194	1.362,57	1.812,51
500	400	1	BBN00228551016000.	672	775,91	1.054,55
500	400	2	BBN00228551026000.	1.086	1.249,79	1.685,76
500	400	3	BBN00228551036000.	1.514	1.739,09	2.339,05
750	250	1	BBN00224751016000.	482	552,88	741,60
750	250	2	BBN00224751026000.	811	925,14	1.231,16
750	250	3	BBN00224751036000.	1.155	1.316,43	1.747,20
750	300	1	BBN00226751016000.	575	662,33	895,62
750	300	2	BBN00226751026000.	956	1.095,78	1.470,71
750	300	3	BBN00226751036000.	1.354	1.550,63	2.075,85
750	400	1	BBN00228751016000.	737	852,65	1.161,88
750	400	2	BBN00228751026000.	1.203	1.387,57	1.878,87
750	400	3	BBN00228751036000.	1.690	1.946,04	2.628,45
900	250	1	BBN00224951016000.	482	552,88	741,60
900	250	2	BBN00224951026000.	811	925,14	1.231,16
900	300	1	BBN00226951016000.	575	662,33	895,62
900	300	2	BBN00226951026000.	956	1.095,78	1.470,71
900	400	1	BBN00228951016000.	737	852,65	1.161,88
900	400	2	BBN00228951026000.	1.203	1.387,57	1.878,87
1000	250	1	BBN00224151016000.	510	584,13	781,50
1000	250	2	BBN00224151026000.	864	983,80	1.304,85
1000	300	1	BBN00226151016000.	606	696,25	938,58
1000	300	2	BBN00226151026000.	1.012	1.158,82	1.550,37
1000	400	1	BBN00228151016000.	769	888,70	1.208,03
1000	400	2	BBN00228151026000.	1.264	1.454,61	1.964,53

LINGO SHELVING SYSTEM

DOUBLE-SIDED - STEEL BACK FRAME - ADJUSTABLE FEET - WITH OVERLAYING WOODEN TOP PLATE

Painted and veneered Lingo Shelving Systems are FSC-certified. Configurations with more than 2/3 bays are available.

H920 mm

Module mm	Shelf depth mm	No. of bays	Item no.	Melamine EUR	Painted EUR	Veneer EUR
500	250	1	BBN00234551016000.	496	568,97	764,34
500	250	2	BBN00234551026000.	815	930,73	1.239,02
500	250	3	BBN00234551036000.	1.146	1.305,38	1.731,91
500	300	1	BBN00236551016000.	604	696,92	943,78
500	300	2	BBN00236551026000.	982	1.126,91	1.513,95
500	300	3	BBN00236551036000.	1.371	1.571,13	2.104,07
500	400	1	BBN00238551016000.	800	926,47	1.265,23
500	400	2	BBN00238551026000.	1.279	1.475,63	2.001,78
500	400	3	BBN00238551036000.	1.771	2.040,21	2.760,41
750	250	1	BBN00234751016000.	549	631,88	852,26
750	250	2	BBN00234751026000.	911	1.043,64	1.397,15
750	250	3	BBN00234751036000.	1.289	1.474,43	1.968,52
750	300	1	BBN00236751016000.	664	766,61	1.041,40
750	300	2	BBN00236751026000.	1.088	1.252,20	1.689,38
750	300	3	BBN00236751036000.	1.531	1.759,19	2.367,41
750	400	1	BBN00238751016000.	865	1.003,21	1.372,56
750	400	2	BBN00238751026000.	1.396	1.613,41	2.194,89
750	400	3	BBN00238751036000.	1.947	2.247,16	3.049,81
900	250	1	BBN00234951016000.	549	631,88	852,26
900	250	2	BBN00234951026000.	911	1.043,64	1.397,15
900	300	1	BBN00236951016000.	664	766,61	1.041,40
900	300	2	BBN00236951026000.	1.088	1.252,20	1.689,38
900	400	1	BBN00238951016000.	865	1.003,21	1.372,56
900	400	2	BBN00238951026000.	1.396	1.613,41	2.194,89
1000	250	1	BBN00234151016000.	577	663,13	892,16
1000	250	2	BBN00234151026000.	964	1.102,30	1.470,84
1000	300	1	BBN00236151016000.	694	800,53	1.084,36
1000	300	2	BBN00236151026000.	1.145	1.315,24	1.769,04
1000	400	1	BBN00238151016000.	897	1.039,26	1.418,71
1000	400	2	BBN00238151026000.	1.456	1.680,45	2.280,55

LINGO SHELVING SYSTEM

DOUBLE-SIDED - STEEL BACK FRAME - ADJUSTABLE FEET - WITH OVERLAYING WOODEN TOP PLATE

Painted and veneered Lingo Shelving Systems are FSC-certified. Configurations with more than 2/3 bays are available.

H1220 mm

Module mm	Shelf depth mm	No. of bays	Item no.	Melamine EUR	Painted EUR	Veneer EUR
500	250	1	BBN00244551016000.	594	685,21	927,40
500	250	2	BBN00244551026000.	963	1.105,09	1.483,61
500	250	3	BBN00244551036000.	1.343	1.537,86	2.058,03
500	300	1	BBN00246551016000.	726	839,76	1.144,06
500	300	2	BBN00246551026000.	1.164	1.341,17	1.814,37
500	300	3	BBN00246551036000.	1.614	1.856,81	2.504,63
500	400	1	BBN00248551016000.	977	1.135,01	1.557,57
500	400	2	BBN00248551026000.	1.544	1.788,44	2.440,29
500	400	3	BBN00248551036000.	2.124	2.457,29	3.345,09
750	250	1	BBN00244751016000.	648	748,12	1.015,32
750	250	2	BBN00244751026000.	1.059	1.218,00	1.641,74
750	250	3	BBN00244751036000.	1.487	1.706,91	2.294,64
750	300	1	BBN00246751016000.	785	909,45	1.241,68
750	300	2	BBN00246751026000.	1.270	1.466,46	1.989,80
750	300	3	BBN00246751036000.	1.774	2.044,87	2.767,97
750	400	1	BBN00248751016000.	1.042	1.211,75	1.664,90
750	400	2	BBN00248751026000.	1.661	1.926,22	2.633,40
750	400	3	BBN00248751036000.	2.300	2.664,24	3.634,49
900	250	1	BBN00244951016000.	648	748,12	1.015,32
900	250	2	BBN00244951026000.	1.059	1.218,00	1.641,74
900	300	1	BBN00246951016000.	785	909,45	1.241,68
900	300	2	BBN00246951026000.	1.270	1.466,46	1.989,80
900	400	1	BBN00248951016000.	1.042	1.211,75	1.664,90
900	400	2	BBN00248951026000.	1.661	1.926,22	2.633,40
1000	250	1	BBN00244151016000.	676	779,37	1.055,22
1000	250	2	BBN00244151026000.	1.112	1.276,66	1.715,43
1000	300	1	BBN00246151016000.	815	943,37	1.284,64
1000	300	2	BBN00246151026000.	1.327	1.529,50	2.069,46
1000	400	1	BBN00248151016000.	1.074	1.247,80	1.711,05
1000	400	2	BBN00248151026000.	1.721	1.993,26	2.719,06

LINGO SHELVING SYSTEM

DOUBLE-SIDED - STEEL BACK FRAME - ADJUSTABLE FEET - WITH OVERLAYING WOODEN TOP PLATE

Painted and veneered Lingo Shelving Systems are FSC-certified. Configurations with more than 2/3 bays are available.

H1520 mm

Module mm	Shelf depth mm	No. of bays	Item no.	Melamine EUR	Painted EUR	Veneer EUR
500	250	1	BBN00254551016000.	666	765,01	1.028,74
500	250	2	BBN00254551026000.	1.082	1.236,76	1.647,59
500	250	3	BBN00254551036000.	1.510	1.721,40	2.284,65
500	300	1	BBN00256551016000.	778	896,94	1.214,56
500	300	2	BBN00256551026000.	1.254	1.438,91	1.932,09
500	300	3	BBN00256551036000.	1.742	1.995,11	2.669,57
500	400	1	BBN00258551016000.	1.041	1.206,57	1.647,73
500	400	2	BBN00258551026000.	1.652	1.907,75	2.587,50
500	400	3	BBN00258551036000.	2.277	2.624,35	3.549,35
750	250	1	BBN00254751016000.	719	827,92	1.116,66
750	250	2	BBN00254751026000.	1.179	1.349,67	1.805,72
750	250	3	BBN00254751036000.	1.654	1.890,45	2.521,26
750	300	1	BBN00256751016000.	837	966,63	1.312,18
750	300	2	BBN00256751026000.	1.361	1.564,20	2.107,52
750	300	3	BBN00256751036000.	1.902	2.183,17	2.932,91
750	400	1	BBN00258751016000.	1.106	1.283,31	1.755,06
750	400	2	BBN00258751026000.	1.770	2.045,53	2.780,61
750	400	3	BBN00258751036000.	2.453	2.831,30	3.838,75
900	250	1	BBN00254951016000.	719	827,92	1.116,66
900	250	2	BBN00254951026000.	1.179	1.349,67	1.805,72
900	300	1	BBN00256951016000.	837	966,63	1.312,18
900	300	2	BBN00256951026000.	1.361	1.564,20	2.107,52
900	400	1	BBN00258951016000.	1.106	1.283,31	1.755,06
900	400	2	BBN00258951026000.	1.770	2.045,53	2.780,61
1000	250	1	BBN00254151016000.	751	862,10	1.159,49
1000	250	2	BBN00254151026000.	1.237	1.414,19	1.885,27
1000	300	1	BBN00256151016000.	870	1.003,48	1.358,07
1000	300	2	BBN00256151026000.	1.423	1.633,10	2.193,04
1000	400	1	BBN00258151016000.	1.141	1.322,29	1.804,14
1000	400	2	BBN00258151026000.	1.836	2.118,43	2.872,13

LINGO SHELVING SYSTEM

DOUBLE-SIDED - STEEL BACK FRAME - ADJUSTABLE FEET - WITH OVERLAYING WOODEN TOP PLATE

Painted and veneered Lingo Shelving Systems are FSC-certified. Configurations with more than 2/3 bays are available.

H1820 mm

Module mm	Shelf depth mm	No. of bays	Item no.	Melamine EUR	Painted EUR	Veneer EUR
500	250	1	BBN00264551016000.	804	917,30	1.220,67
500	250	2	BBN00264551026000.	1.238	1.414,32	1.884,61
500	250	3	BBN00264551036000.	1.684	1.924,23	2.566,76
500	300	1	BBN00266551016000.	935	1.071,85	1.436,27
500	300	2	BBN00266551026000.	1.438	1.650,40	2.213,78
500	300	3	BBN00266551036000.	1.954	2.243,18	3.011,24
500	400	1	BBN00268551016000.	1.245	1.436,52	1.947,92
500	400	2	BBN00268551026000.	1.907	2.201,80	2.986,91
500	400	3	BBN00268551036000.	2.583	2.982,50	4.047,98
750	250	1	BBN00264751016000.	857	980,21	1.308,59
750	250	2	BBN00264751026000.	1.334	1.527,23	2.042,74
750	250	3	BBN00264751036000.	1.827	2.093,28	2.803,37
750	300	1	BBN00266751016000.	994	1.141,54	1.533,89
750	300	2	BBN00266751026000.	1.545	1.775,69	2.389,21
750	300	3	BBN00266751036000.	2.114	2.431,24	3.274,58
750	400	1	BBN00268751016000.	1.310	1.513,26	2.055,25
750	400	2	BBN00268751026000.	2.025	2.339,58	3.180,02
750	400	3	BBN00268751036000.	2.759	3.189,45	4.337,38
900	250	1	BBN00264951016000.	857	980,21	1.308,59
900	250	2	BBN00264951026000.	1.334	1.527,23	2.042,74
900	300	1	BBN00266951016000.	994	1.141,54	1.533,89
900	300	2	BBN00266951026000.	1.545	1.775,69	2.389,21
900	400	1	BBN00268951016000.	1.310	1.513,26	2.055,25
900	400	2	BBN00268951026000.	2.025	2.339,58	3.180,02
1000	250	1	BBN00264151016000.	896	1.022,10	1.359,13
1000	250	2	BBN00264151026000.	1.398	1.596,53	2.127,07
1000	300	1	BBN00266151016000.	1.035	1.186,10	1.587,49
1000	300	2	BBN00266151026000.	1.612	1.849,37	2.479,51
1000	400	1	BBN00268151016000.	1.353	1.559,95	2.112,04
1000	400	2	BBN00268151026000.	2.095	2.417,26	3.276,32

LINGO SHELVING SYSTEM

DOUBLE-SIDED - STEEL BACK FRAME - ADJUSTABLE FEET - WITH OVERLAYING WOODEN TOP PLATE

Painted and veneered Lingo Shelving Systems are FSC-certified. Configurations with more than 2/3 bays are available.

H2120 mm

Module mm	Shelf depth mm	No. of bays	Item no.	Melamine EUR	Painted EUR	Veneer EUR
500	250	1	BBN00274551016000.	873	998,96	1.334,77
500	250	2	BBN00274551026000.	1.343	1.536,81	2.055,76
500	250	3	BBN00274551036000.	1.823	2.087,55	2.794,96
500	300	1	BBN00276551016000.	1.032	1.186,23	1.596,67
500	300	2	BBN00276551026000.	1.584	1.821,97	2.454,38
500	300	3	BBN00276551036000.	2.149	2.471,94	3.332,04
500	400	1	BBN00278551016000.	1.387	1.603,30	2.181,20
500	400	2	BBN00278551026000.	2.121	2.451,97	3.336,83
500	400	3	BBN00278551036000.	2.868	3.316,06	4.514,54
750	250	1	BBN00274751016000.	926	1.061,87	1.422,69
750	250	2	BBN00274751026000.	1.439	1.649,72	2.213,89
750	250	3	BBN00274751036000.	1.967	2.256,60	3.031,57
750	300	1	BBN00276751016000.	1.092	1.255,92	1.694,29
750	300	2	BBN00276751026000.	1.691	1.947,26	2.629,81
750	300	3	BBN00276751036000.	2.309	2.660,00	3.595,38
750	400	1	BBN00278751016000.	1.453	1.680,04	2.288,53
750	400	2	BBN00278751026000.	2.238	2.589,75	3.529,94
750	400	3	BBN00278751036000.	3.044	3.523,01	4.803,94
900	250	1	BBN00274951016000.	926	1.061,87	1.422,69
900	250	2	BBN00274951026000.	1.439	1.649,72	2.213,89
900	300	1	BBN00276951016000.	1.092	1.255,92	1.694,29
900	300	2	BBN00276951026000.	1.691	1.947,26	2.629,81
900	400	1	BBN00278951016000.	1.453	1.680,04	2.288,53
900	400	2	BBN00278951026000.	2.238	2.589,75	3.529,94
1000	250	1	BBN00274151016000.	966	1.103,76	1.473,23
1000	250	2	BBN00274151026000.	1.502	1.719,02	2.298,22
1000	300	1	BBN00276151016000.	1.132	1.300,48	1.747,89
1000	300	2	BBN00276151026000.	1.758	2.020,94	2.720,11
1000	400	1	BBN00278151016000.	1.495	1.726,73	2.345,32
1000	400	2	BBN00278151026000.	2.309	2.667,43	3.626,24

LINGO SHELVING SYSTEM

BBN002 - WOODEN BACK PANEL - ADJUSTABLE FEET - WITH OVERLAYING WOODEN TOP PLATE



LINGO SHELVING SYSTEM

BBN002 - WOODEN BACK PANEL - ADJUSTABLE FEET - WITH OVERLAYING WOODEN TOP PLATE

Shelving system with wooden panels, wooden back panel and overlaying top plate.
For configurations with more than 3 bays, please contact Customer Service.

- Prices based on steel price group 1 and wooden price group A (see Design Options pages 6-9).
- For shelves see page 144 & 166.
- For accessories see page 186.

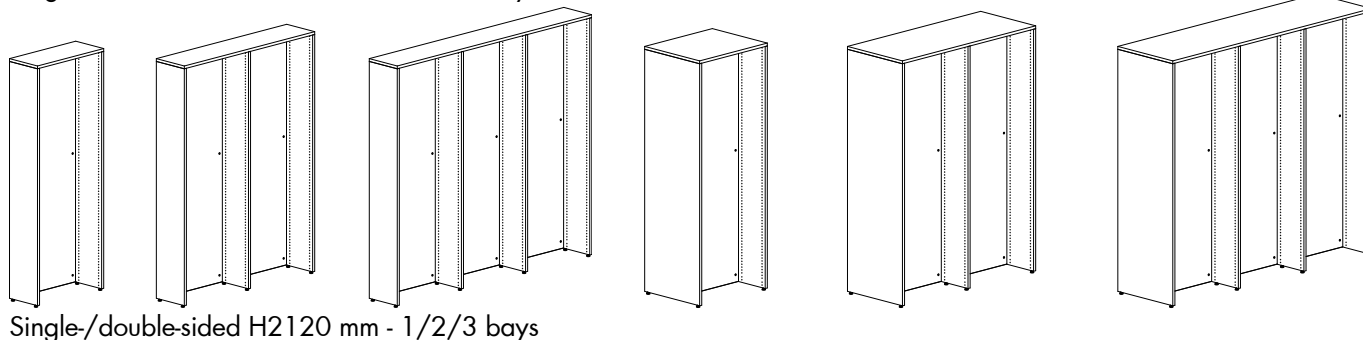
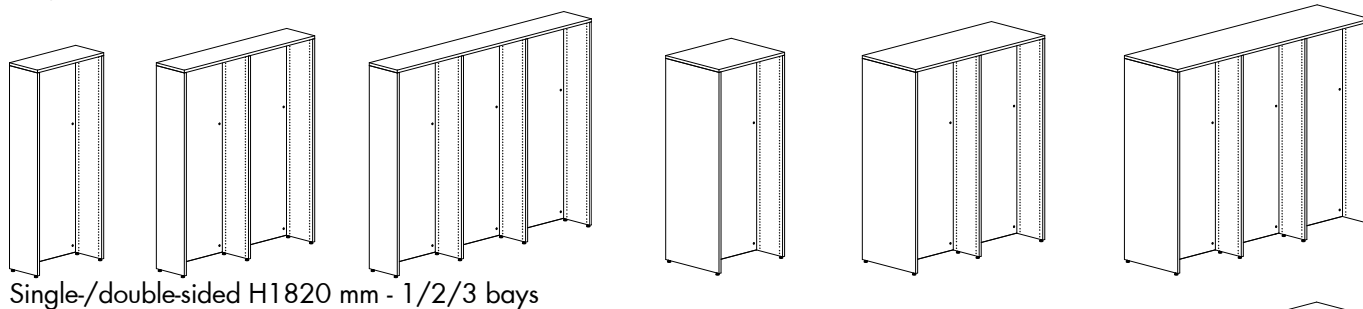
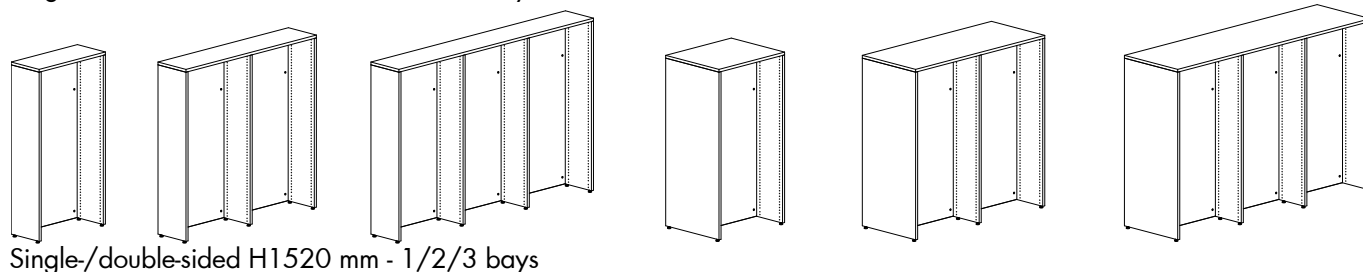
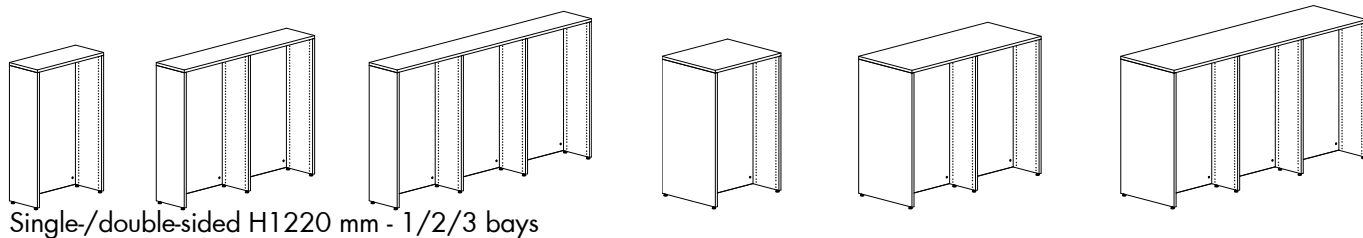
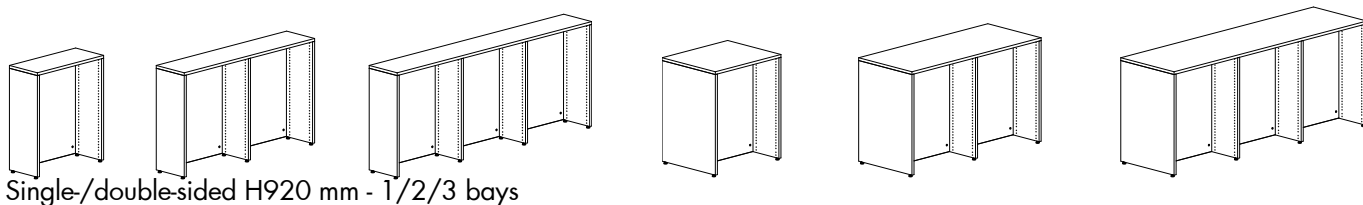
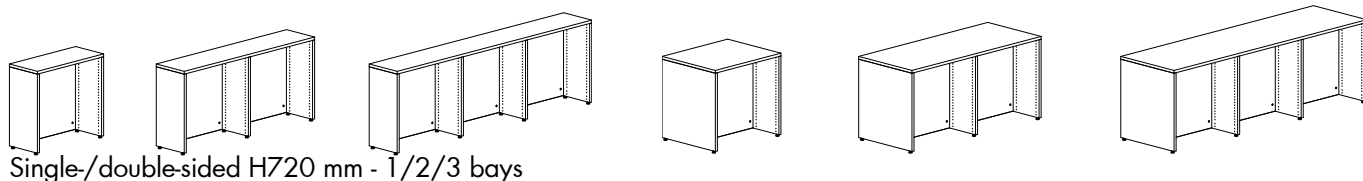

LINGO SHELVING SYSTEM

SINGLE-SIDED - WOODEN BACK PANEL - ADJUSTABLE FEET - WITH OVERLAYING WOODEN TOP PLATE

Painted and veneered Lingo Shelving Systems are FSC-certified. Configurations with more than 2/3 bays are available.

H720 mm

Module mm	Shelf depth mm	No. of bays	Item no.	Melamine EUR	Painted EUR	Veneer EUR
500	250	1	BBN00223551013000.	304	357,91	501,67
500	250	2	BBN00223551023000.	512	602,23	844,02
500	250	3	BBN00223551033000.	726	854,53	1.197,53
500	300	1	BBN00225551013000.	336	394,87	553,56
500	300	2	BBN00225551023000.	562	660,47	925,43
500	300	3	BBN00225551033000.	795	934,84	1.310,20
500	400	1	BBN00227551013000.	411	483,45	677,38
500	400	2	BBN00227551023000.	677	795,74	1.114,55
500	400	3	BBN00227551033000.	951	1.118,13	1.566,22
750	250	1	BBN00223751013000.	373	439,70	616,06
750	250	2	BBN00223751023000.	643	757,30	1.061,08
750	250	3	BBN00223751033000.	923	1.087,14	1.523,52
750	300	1	BBN00225751013000.	409	481,32	674,59
750	300	2	BBN00225751023000.	700	823,52	1.154,46
750	300	3	BBN00225751033000.	1.003	1.179,69	1.653,75
750	400	1	BBN00227751013000.	488	574,29	804,40
750	400	2	BBN00227751023000.	822	967,30	1.354,89
750	400	3	BBN00227751033000.	1.168	1.375,47	1.926,93
900	250	1	BBN00223951013000.	399	470,16	658,48
900	250	2	BBN00223951023000.	695	818,22	1.145,92
900	300	1	BBN00225951013000.	435	511,78	717,01
900	300	2	BBN00225951023000.	752	884,44	1.239,30
900	400	1	BBN00227951013000.	514	604,75	846,82
900	400	2	BBN00227951023000.	874	1.028,22	1.439,73
1000	250	1	BBN00223151013000.	420	494,23	691,86
1000	250	2	BBN00223151023000.	733	863,30	1.208,69
1000	300	1	BBN00225151013000.	457	537,18	752,25
1000	300	2	BBN00225151023000.	793	932,44	1.305,93
1000	400	1	BBN00227151013000.	537	631,61	884,45
1000	400	2	BBN00227151023000.	917	1.079,02	1.509,95

LINGO SHELVING SYSTEM

SINGLE-SIDED - WOODEN BACK PANEL - ADJUSTABLE FEET - WITH OVERLAYING WOODEN TOP PLATE

Painted and veneered Lingo Shelving Systems are FSC-certified. Configurations with more than 2/3 bays are available.

H920 mm

Module mm	Shelf depth mm	No. of bays	Item no.	Melamine EUR	Painted EUR	Veneer EUR
500	250	1	BBN00233551013000.	370	435,31	609,26
500	250	2	BBN00233551023000.	620	729,77	1.021,43
500	250	3	BBN00233551033000.	877	1.032,21	1.444,76
500	300	1	BBN00235551013000.	408	480,01	672,85
500	300	2	BBN00235551023000.	680	799,62	1.120,39
500	300	3	BBN00235551033000.	959	1.128,00	1.580,83
500	400	1	BBN00237551013000.	502	590,13	826,99
500	400	2	BBN00237551023000.	822	967,20	1.354,99
500	400	3	BBN00237551033000.	1.152	1.354,37	1.897,49
750	250	1	BBN00233751013000.	449	528,27	739,08
750	250	2	BBN00233751023000.	771	907,18	1.269,35
750	250	3	BBN00233751033000.	1.104	1.298,33	1.817,04
750	300	1	BBN00235751013000.	491	577,63	809,31
750	300	2	BBN00235751023000.	838	985,01	1.380,28
750	300	3	BBN00235751033000.	1.196	1.406,36	1.970,67
750	400	1	BBN00237751013000.	589	692,14	969,44
750	400	2	BBN00237751023000.	987	1.161,10	1.626,19
750	400	3	BBN00237751033000.	1.399	1.645,22	2.304,49
900	250	1	BBN00233951013000.	482	567,51	793,87
900	250	2	BBN00233951023000.	838	985,66	1.378,93
900	300	1	BBN00235951013000.	524	616,87	864,10
900	300	2	BBN00235951023000.	904	1.063,49	1.489,86
900	400	1	BBN00237951013000.	622	731,38	1.024,23
900	400	2	BBN00237951023000.	1.054	1.239,58	1.735,77
1000	250	1	BBN00233151013000.	505	594,11	830,71
1000	250	2	BBN00233151023000.	880	1.035,80	1.448,62
1000	300	1	BBN00235151013000.	548	644,80	902,80
1000	300	2	BBN00235151023000.	950	1.116,55	1.563,41
1000	400	1	BBN00237151013000.	647	760,77	1.065,32
1000	400	2	BBN00237151023000.	1.102	1.295,44	1.812,91

LINGO SHELVING SYSTEM

SINGLE-SIDED - WOODEN BACK PANEL - ADJUSTABLE FEET - WITH OVERLAYING WOODEN TOP PLATE

Painted and veneered Lingo Shelving Systems are FSC-certified. Configurations with more than 2/3 bays are available.

H1220 mm

Module mm	Shelf depth mm	No. of bays	Item no.	Melamine EUR	Painted EUR	Veneer EUR
500	250	1	BBN00243551013000.	468	550,62	771,65
500	250	2	BBN00243551023000.	782	920,22	1.289,42
500	250	3	BBN00243551033000.	1.103	1.297,80	1.818,35
500	300	1	BBN00245551013000.	488	574,30	803,86
500	300	2	BBN00245551023000.	814	958,54	1.341,31
500	300	3	BBN00245551033000.	1.149	1.351,55	1.891,66
500	400	1	BBN00247551013000.	628	738,68	1.034,34
500	400	2	BBN00247551023000.	1.026	1.207,51	1.690,42
500	400	3	BBN00247551033000.	1.433	1.686,44	2.361,00
750	250	1	BBN00243751013000.	562	661,28	926,07
750	250	2	BBN00243751023000.	964	1.133,03	1.586,54
750	250	3	BBN00243751033000.	1.375	1.617,02	2.264,43
750	300	1	BBN00245751013000.	586	689,62	964,92
750	300	2	BBN00245751023000.	1.003	1.179,33	1.650,40
750	300	3	BBN00245751033000.	1.431	1.683,01	2.355,30
750	400	1	BBN00247751013000.	730	858,39	1.201,39
750	400	2	BBN00247751023000.	1.221	1.436,81	2.010,82
750	400	3	BBN00247751033000.	1.726	2.030,39	2.841,80
900	250	1	BBN00243951013000.	599	704,50	986,99
900	250	2	BBN00243951023000.	1.037	1.219,47	1.708,38
900	300	1	BBN00245951013000.	623	732,84	1.025,84
900	300	2	BBN00245951023000.	1.076	1.265,77	1.772,24
900	400	1	BBN00247951013000.	766	901,61	1.262,31
900	400	2	BBN00247951023000.	1.295	1.523,25	2.132,66
1000	250	1	BBN00243151013000.	633	744,27	1.042,18
1000	250	2	BBN00243151023000.	1.102	1.295,95	1.814,77
1000	300	1	BBN00245151013000.	658	773,94	1.082,89
1000	300	2	BBN00245151023000.	1.144	1.345,17	1.882,49
1000	400	1	BBN00247151013000.	803	944,17	1.321,75
1000	400	2	BBN00247151023000.	1.365	1.605,45	2.246,50

LINGO SHELVING SYSTEM

SINGLE-SIDED - WOODEN BACK PANEL - ADJUSTABLE FEET - WITH OVERLAYING WOODEN TOP PLATE

Painted and veneered Lingo Shelving Systems are FSC-certified. Configurations with more than 2/3 bays are available.

H1520 mm

Module mm	Shelf depth mm	No. of bays	Item no.	Melamine EUR	Painted EUR	Veneer EUR
500	250	1	BBN00253551013000.	533	627,23	878,34
500	250	2	BBN00253551023000.	893	1.050,70	1.471,27
500	250	3	BBN00253551033000.	1.260	1.482,15	2.075,36
500	300	1	BBN00255551013000.	553	650,65	910,25
500	300	2	BBN00255551023000.	925	1.088,63	1.522,71
500	300	3	BBN00255551033000.	1.304	1.535,38	2.148,07
500	400	1	BBN00257551013000.	720	846,15	1.184,37
500	400	2	BBN00257551023000.	1.177	1.384,28	1.937,28
500	400	3	BBN00257551033000.	1.643	1.932,51	2.704,69
750	250	1	BBN00253751013000.	640	753,44	1.054,57
750	250	2	BBN00253751023000.	1.100	1.294,61	1.812,01
750	250	3	BBN00253751033000.	1.570	1.848,02	2.586,87
750	300	1	BBN00255751013000.	664	781,52	1.093,12
750	300	2	BBN00255751023000.	1.139	1.340,52	1.875,42
750	300	3	BBN00255751033000.	1.626	1.913,49	2.677,14
750	400	1	BBN00257751013000.	834	981,41	1.373,23
750	400	2	BBN00257751023000.	1.398	1.644,68	2.301,30
750	400	3	BBN00257751033000.	1.974	2.323,11	3.250,92
900	250	1	BBN00253951013000.	689	810,37	1.134,64
900	250	2	BBN00253951023000.	1.197	1.408,47	1.972,15
900	300	1	BBN00255951013000.	712	838,45	1.173,19
900	300	2	BBN00255951023000.	1.236	1.454,38	2.035,56
900	400	1	BBN00257951013000.	883	1.038,34	1.453,30
900	400	2	BBN00257951023000.	1.495	1.758,54	2.461,44
1000	250	1	BBN00253151013000.	725	852,93	1.193,42
1000	250	2	BBN00253151023000.	1.267	1.490,53	2.085,72
1000	300	1	BBN00255151013000.	750	882,34	1.233,83
1000	300	2	BBN00255151023000.	1.308	1.539,36	2.152,99
1000	400	1	BBN00257151013000.	921	1.083,69	1.516,33
1000	400	2	BBN00257151023000.	1.569	1.846,32	2.582,46

LINGO SHELVING SYSTEM

SINGLE-SIDED - WOODEN BACK PANEL - ADJUSTABLE FEET - WITH OVERLAYING WOODEN TOP PLATE

Painted and veneered Lingo Shelving Systems are FSC-certified. Configurations with more than 2/3 bays are available.

H1820 mm

Module mm	Shelf depth mm	No. of bays	Item no.	Melamine EUR	Painted EUR	Veneer EUR
500	250	1	BBN00263551013000.	612	719,26	1.006,94
500	250	2	BBN00263551023000.	1.022	1.202,44	1.683,12
500	250	3	BBN00263551033000.	1.440	1.693,60	2.370,46
500	300	1	BBN00265551013000.	628	738,68	1.033,27
500	300	2	BBN00265551023000.	1.049	1.234,37	1.726,19
500	300	3	BBN00265551033000.	1.478	1.738,83	2.432,01
500	400	1	BBN00267551013000.	813	956,52	1.339,57
500	400	2	BBN00267551023000.	1.329	1.563,53	2.189,03
500	400	3	BBN00267551033000.	1.854	2.180,64	3.052,99
750	250	1	BBN00263751013000.	730	858,78	1.202,46
750	250	2	BBN00263751023000.	1.252	1.472,97	2.062,44
750	250	3	BBN00263751033000.	1.785	2.099,40	2.939,84
750	300	1	BBN00265751013000.	750	882,86	1.235,43
750	300	2	BBN00265751023000.	1.286	1.512,88	2.117,48
750	300	3	BBN00265751033000.	1.834	2.156,87	3.018,95
750	400	1	BBN00267751013000.	939	1.105,09	1.547,72
750	400	2	BBN00267751023000.	1.573	1.850,55	2.591,63
750	400	3	BBN00267751033000.	2.219	2.611,17	3.657,09
900	250	1	BBN00263951013000.	791	930,87	1.302,87
900	250	2	BBN00263951023000.	1.374	1.617,15	2.263,26
900	300	1	BBN00265951013000.	811	954,95	1.335,84
900	300	2	BBN00265951023000.	1.408	1.657,06	2.318,30
900	400	1	BBN00267951013000.	1.000	1.177,18	1.648,13
900	400	2	BBN00267951023000.	1.695	1.994,73	2.792,45
1000	250	1	BBN00263151013000.	826	971,30	1.359,80
1000	250	2	BBN00263151023000.	1.441	1.694,95	2.373,13
1000	300	1	BBN00265151013000.	847	996,71	1.394,63
1000	300	2	BBN00265151023000.	1.477	1.737,78	2.432,03
1000	400	1	BBN00267151013000.	1.037	1.220,40	1.709,31
1000	400	2	BBN00267151023000.	1.766	2.078,25	2.909,77

LINGO SHELVING SYSTEM

SINGLE-SIDED - WOODEN BACK PANEL - ADJUSTABLE FEET - WITH OVERLAYING WOODEN TOP PLATE

Painted and veneered Lingo Shelving Systems are FSC-certified. Configurations with more than 2/3 bays are available.

H2120 mm

Module mm	Shelf depth mm	No. of bays	Item no.	Melamine EUR	Painted EUR	Veneer EUR
500	250	1	BBN00273551013000.	681	800,39	1.121,06
500	250	2	BBN00273551023000.	1.139	1.339,43	1.875,98
500	250	3	BBN00273551033000.	1.604	1.886,45	2.642,06
500	300	1	BBN00275551013000.	696	818,75	1.146,33
500	300	2	BBN00275551023000.	1.165	1.369,77	1.917,46
500	300	3	BBN00275551033000.	1.641	1.929,56	2.701,49
500	400	1	BBN00277551013000.	894	1.051,23	1.471,79
500	400	2	BBN00277551023000.	1.463	1.720,89	2.409,04
500	400	3	BBN00277551033000.	2.041	2.400,65	3.360,79
750	250	1	BBN00273751013000.	812	955,60	1.337,46
750	250	2	BBN00273751023000.	1.395	1.641,34	2.297,06
750	250	3	BBN00273751033000.	1.988	2.339,32	3.274,08
750	300	1	BBN00275751013000.	832	978,62	1.369,37
750	300	2	BBN00275751023000.	1.427	1.679,66	2.350,51
750	300	3	BBN00275751033000.	2.035	2.394,67	3.351,07
750	400	1	BBN00277751013000.	1.033	1.215,49	1.700,82
750	400	2	BBN00277751023000.	1.733	2.039,29	2.853,40
750	400	3	BBN00277751033000.	2.446	2.878,25	4.027,53
900	250	1	BBN00273951013000.	882	1.038,06	1.453,57
900	250	2	BBN00273951023000.	1.535	1.806,26	2.529,28
900	300	1	BBN00275951013000.	902	1.061,08	1.485,48
900	300	2	BBN00275951023000.	1.568	1.844,58	2.582,73
900	400	1	BBN00277951013000.	1.103	1.297,95	1.816,93
900	400	2	BBN00277951023000.	1.873	2.204,21	3.085,62
1000	250	1	BBN00273151013000.	920	1.083,29	1.516,61
1000	250	2	BBN00273151023000.	1.609	1.893,66	2.651,37
1000	300	1	BBN00275151013000.	941	1.107,64	1.550,38
1000	300	2	BBN00275151023000.	1.644	1.934,90	2.708,68
1000	400	1	BBN00277151013000.	1.144	1.345,97	1.884,22
1000	400	2	BBN00277151023000.	1.952	2.297,33	3.215,16

LINGO SHELVING SYSTEM

DOUBLE-SIDED - WOODEN BACK PANEL - ADJUSTABLE FEET - WITH OVERLAYING WOODEN TOP PLATE

Painted and veneered Lingo Shelving Systems are FSC-certified. Configurations with more than 2/3 bays are available.

H720 mm

Module mm	Shelf depth mm	No. of bays	Item no.	Melamine EUR	Painted EUR	Veneer EUR
500	250	1	BBN00224551013000.	418	491,57	688,13
500	250	2	BBN00224551023000.	694	815,43	1.141,93
500	250	3	BBN00224551033000.	980	1.152,18	1.613,94
500	300	1	BBN00226551013000.	505	594,24	832,45
500	300	2	BBN00226551023000.	828	973,69	1.364,18
500	300	3	BBN00226551033000.	1.163	1.367,37	1.915,86
500	400	1	BBN00228551013000.	661	777,51	1.089,00
500	400	2	BBN00228551023000.	1.065	1.252,99	1.754,66
500	400	3	BBN00228551033000.	1.483	1.743,89	2.442,40
750	250	1	BBN00224751013000.	506	595,44	833,51
750	250	2	BBN00224751023000.	859	1.010,26	1.414,98
750	250	3	BBN00224751033000.	1.227	1.444,11	2.022,93
750	300	1	BBN00226751013000.	599	704,89	987,53
750	300	2	BBN00226751023000.	1.004	1.180,90	1.654,53
750	300	3	BBN00226751033000.	1.427	1.678,31	2.351,58
750	400	1	BBN00228751013000.	761	895,21	1.253,79
750	400	2	BBN00228751023000.	1.252	1.472,69	2.062,69
750	400	3	BBN00228751033000.	1.762	2.073,72	2.904,18
900	250	1	BBN00224951013000.	532	625,90	875,93
900	250	2	BBN00224951023000.	911	1.071,18	1.499,82
900	300	1	BBN00226951013000.	625	735,35	1.029,95
900	300	2	BBN00226951023000.	1.056	1.241,82	1.739,37
900	400	1	BBN00228951013000.	787	925,67	1.296,21
900	400	2	BBN00228951023000.	1.304	1.533,61	2.147,53
1000	250	1	BBN00224151013000.	559	656,88	919,42
1000	250	2	BBN00224151023000.	960	1.129,30	1.580,69
1000	300	1	BBN00226151013000.	654	769,00	1.076,50
1000	300	2	BBN00226151023000.	1.109	1.304,32	1.826,21
1000	400	1	BBN00228151013000.	817	961,45	1.345,95
1000	400	2	BBN00228151023000.	1.360	1.600,11	2.240,37

LINGO SHELVING SYSTEM

DOUBLE-SIDED - WOODEN BACK PANEL - ADJUSTABLE FEET - WITH OVERLAYING WOODEN TOP PLATE

Painted and veneered Lingo Shelving Systems are FSC-certified. Configurations with more than 2/3 bays are available.

H920 mm

Module mm	Shelf depth mm	No. of bays	Item no.	Melamine EUR	Painted EUR	Veneer EUR
500	250	1	BBN00234551013000.	504	593,45	830,84
500	250	2	BBN00234551023000.	833	979,69	1.372,02
500	250	3	BBN00234551033000.	1.172	1.378,82	1.931,41
500	300	1	BBN00236551013000.	613	721,40	1.010,28
500	300	2	BBN00236551023000.	999	1.175,87	1.646,95
500	300	3	BBN00236551033000.	1.397	1.644,57	2.303,57
500	400	1	BBN00238551013000.	809	950,95	1.331,73
500	400	2	BBN00238551023000.	1.296	1.524,59	2.134,78
500	400	3	BBN00238551033000.	1.797	2.113,65	2.959,91
750	250	1	BBN00234751013000.	602	708,49	991,65
750	250	2	BBN00234751023000.	1.018	1.196,86	1.675,93
750	250	3	BBN00234751033000.	1.449	1.704,26	2.386,69
750	300	1	BBN00236751013000.	717	843,22	1.180,79
750	300	2	BBN00236751023000.	1.194	1.405,42	1.968,16
750	300	3	BBN00236751033000.	1.691	1.989,02	2.785,58
750	400	1	BBN00238751013000.	918	1.079,82	1.511,95
750	400	2	BBN00238751023000.	1.502	1.766,63	2.473,67
750	400	3	BBN00238751033000.	2.106	2.476,99	3.467,98
900	250	1	BBN00234951013000.	635	747,73	1.046,44
900	250	2	BBN00234951023000.	1.084	1.275,34	1.785,51
900	300	1	BBN00236951013000.	750	882,46	1.235,58
900	300	2	BBN00236951023000.	1.261	1.483,90	2.077,74
900	400	1	BBN00238951013000.	951	1.119,06	1.566,74
900	400	2	BBN00238951023000.	1.569	1.845,11	2.583,25
1000	250	1	BBN00234151013000.	664	781,24	1.093,39
1000	250	2	BBN00234151023000.	1.138	1.338,52	1.873,30
1000	300	1	BBN00236151013000.	781	918,64	1.285,59
1000	300	2	BBN00236151023000.	1.319	1.551,46	2.171,50
1000	400	1	BBN00238151013000.	984	1.157,37	1.619,94
1000	400	2	BBN00238151023000.	1.630	1.916,67	2.683,01

LINGO SHELVING SYSTEM

DOUBLE-SIDED - WOODEN BACK PANEL - ADJUSTABLE FEET - WITH OVERLAYING WOODEN TOP PLATE

Painted and veneered Lingo Shelving Systems are FSC-certified. Configurations with more than 2/3 bays are available.

H1220 mm

Module mm	Shelf depth mm	No. of bays	Item no.	Melamine EUR	Painted EUR	Veneer EUR
500	250	1	BBN00244551013000.	633	744,66	1.042,71
500	250	2	BBN00244551023000.	1.040	1.223,99	1.714,23
500	250	3	BBN00244551033000.	1.458	1.716,21	2.403,96
500	300	1	BBN00246551013000.	764	899,21	1.259,37
500	300	2	BBN00246551023000.	1.241	1.460,07	2.044,99
500	300	3	BBN00246551033000.	1.730	2.035,16	2.850,56
500	400	1	BBN00248551013000.	1.015	1.194,46	1.672,88
500	400	2	BBN00248551023000.	1.621	1.907,34	2.670,91
500	400	3	BBN00248551033000.	2.240	2.635,64	3.691,02
750	250	1	BBN00244751013000.	746	877,40	1.228,12
750	250	2	BBN00244751023000.	1.255	1.476,56	2.067,34
750	250	3	BBN00244751033000.	1.781	2.094,75	2.933,04
750	300	1	BBN00246751013000.	883	1.038,73	1.454,48
750	300	2	BBN00246751023000.	1.466	1.725,02	2.415,40
750	300	3	BBN00246751033000.	2.068	2.432,71	3.406,37
750	400	1	BBN00248751013000.	1.140	1.341,03	1.877,70
750	400	2	BBN00248751023000.	1.857	2.184,78	3.059,00
750	400	3	BBN00248751033000.	2.594	3.052,08	4.272,89
900	250	1	BBN00244951013000.	782	920,62	1.289,04
900	250	2	BBN00244951023000.	1.328	1.563,00	2.189,18
900	300	1	BBN00246951013000.	920	1.081,95	1.515,40
900	300	2	BBN00246951023000.	1.540	1.811,46	2.537,24
900	400	1	BBN00248951013000.	1.177	1.384,25	1.938,62
900	400	2	BBN00248951023000.	1.930	2.271,22	3.180,84
1000	250	1	BBN00244151013000.	822	967,30	1.354,34
1000	250	2	BBN00244151023000.	1.404	1.652,52	2.313,67
1000	300	1	BBN00246151013000.	962	1.131,30	1.583,76
1000	300	2	BBN00246151023000.	1.620	1.905,36	2.667,70
1000	400	1	BBN00248151013000.	1.220	1.435,73	2.010,17
1000	400	2	BBN00248151023000.	2.014	2.369,12	3.317,30

LINGO SHELVING SYSTEM

DOUBLE-SIDED - WOODEN BACK PANEL - ADJUSTABLE FEET - WITH OVERLAYING WOODEN TOP PLATE

Painted and veneered Lingo Shelving Systems are FSC-certified. Configurations with more than 2/3 bays are available.

H1520 mm

Module mm	Shelf depth mm	No. of bays	Item no.	Melamine EUR	Painted EUR	Veneer EUR
500	250	1	BBN00254551013000.	707	831,65	1.163,74
500	250	2	BBN00254551023000.	1.165	1.370,04	1.917,59
500	250	3	BBN00254551033000.	1.633	1.921,32	2.689,65
500	300	1	BBN00256551013000.	819	963,58	1.349,56
500	300	2	BBN00256551023000.	1.336	1.572,19	2.202,09
500	300	3	BBN00256551033000.	1.866	2.195,03	3.074,57
500	400	1	BBN00258551013000.	1.082	1.273,21	1.782,73
500	400	2	BBN00258551023000.	1.735	2.041,03	2.857,50
500	400	3	BBN00258551033000.	2.400	2.824,27	3.954,35
750	250	1	BBN00254751013000.	833	979,94	1.370,96
750	250	2	BBN00254751023000.	1.406	1.653,71	2.314,32
750	250	3	BBN00254751033000.	1.995	2.346,51	3.284,16
750	300	1	BBN00256751013000.	951	1.118,65	1.566,48
750	300	2	BBN00256751023000.	1.588	1.868,24	2.616,12
750	300	3	BBN00256751033000.	2.243	2.639,23	3.695,81
750	400	1	BBN00258751013000.	1.220	1.435,33	2.009,36
750	400	2	BBN00258751023000.	1.997	2.349,57	3.289,21
750	400	3	BBN00258751033000.	2.794	3.287,36	4.601,65
900	250	1	BBN00254951013000.	881	1.036,87	1.451,03
900	250	2	BBN00254951023000.	1.503	1.767,57	2.474,46
900	300	1	BBN00256951013000.	999	1.175,58	1.646,55
900	300	2	BBN00256951023000.	1.685	1.982,10	2.776,26
900	400	1	BBN00258951013000.	1.268	1.492,26	2.089,43
900	400	2	BBN00258951023000.	2.094	2.463,43	3.449,35
1000	250	1	BBN00254151013000.	924	1.086,34	1.519,92
1000	250	2	BBN00254151023000.	1.583	1.862,67	2.606,13
1000	300	1	BBN00256151013000.	1.043	1.227,72	1.718,50
1000	300	2	BBN00256151023000.	1.769	2.081,58	2.913,90
1000	400	1	BBN00258151013000.	1.314	1.546,53	2.164,57
1000	400	2	BBN00258151023000.	2.181	2.566,91	3.592,99

LINGO SHELVING SYSTEM

DOUBLE-SIDED - WOODEN BACK PANEL - ADJUSTABLE FEET - WITH OVERLAYING WOODEN TOP PLATE

Painted and veneered Lingo Shelving Systems are FSC-certified. Configurations with more than 2/3 bays are available.

H1820 mm

Module mm	Shelf depth mm	No. of bays	Item no.	Melamine EUR	Painted EUR	Veneer EUR
500	250	1	BBN00264551013000.	812	955,34	1.337,58
500	250	2	BBN00264551023000.	1.334	1.569,27	2.197,30
500	250	3	BBN00264551033000.	1.867	2.196,09	3.075,23
500	300	1	BBN00266551013000.	943	1.109,89	1.553,18
500	300	2	BBN00266551023000.	1.534	1.805,35	2.526,47
500	300	3	BBN00266551033000.	2.137	2.515,04	3.519,71
500	400	1	BBN00268551013000.	1.253	1.474,56	2.064,83
500	400	2	BBN00268551023000.	2.003	2.356,75	3.299,60
500	400	3	BBN00268551033000.	2.766	3.254,36	4.556,45
750	250	1	BBN00264751013000.	949	1.116,94	1.564,09
750	250	2	BBN00264751023000.	1.598	1.879,56	2.632,61
750	250	3	BBN00264751033000.	2.262	2.661,21	3.727,61
750	300	1	BBN00266751013000.	1.086	1.278,27	1.789,39
750	300	2	BBN00266751023000.	1.808	2.128,02	2.979,08
750	300	3	BBN00266751033000.	2.549	2.999,17	4.198,82
750	400	1	BBN00268751013000.	1.402	1.649,99	2.310,75
750	400	2	BBN00268751023000.	2.288	2.691,91	3.769,89
750	400	3	BBN00268751033000.	3.194	3.757,38	5.261,62
900	250	1	BBN00264951013000.	1.010	1.189,03	1.664,50
900	250	2	BBN00264951023000.	1.720	2.023,74	2.833,43
900	300	1	BBN00266951013000.	1.148	1.350,36	1.889,80
900	300	2	BBN00266951023000.	1.930	2.272,20	3.179,90
900	400	1	BBN00268951013000.	1.464	1.722,08	2.411,16
900	400	2	BBN00268951023000.	2.410	2.836,09	3.970,71
1000	250	1	BBN00264151013000.	1.051	1.236,37	1.731,54
1000	250	2	BBN00264151023000.	1.797	2.114,58	2.961,40
1000	300	1	BBN00266151013000.	1.190	1.400,37	1.959,90
1000	300	2	BBN00266151023000.	2.012	2.367,42	3.313,84
1000	400	1	BBN00268151013000.	1.508	1.774,22	2.484,45
1000	400	2	BBN00268151023000.	2.495	2.935,31	4.110,65

LINGO SHELVING SYSTEM

DOUBLE-SIDED - WOODEN BACK PANEL - ADJUSTABLE FEET - WITH OVERLAYING WOODEN TOP PLATE

Painted and veneered Lingo Shelving Systems are FSC-certified. Configurations with more than 2/3 bays are available.

H2120 mm

Module mm	Shelf depth mm	No. of bays	Item no.	Melamine EUR	Painted EUR	Veneer EUR
500	250	1	BBN00274551013000.	908	1.067,59	1.495,04
500	250	2	BBN00274551023000.	1.491	1.752,94	2.455,17
500	250	3	BBN00274551033000.	2.085	2.451,18	3.433,51
500	300	1	BBN00276551013000.	1.067	1.254,86	1.756,94
500	300	2	BBN00276551023000.	1.732	2.038,10	2.853,79
500	300	3	BBN00276551033000.	2.411	2.835,57	3.970,59
500	400	1	BBN00278551013000.	1.422	1.671,93	2.341,47
500	400	2	BBN00278551023000.	2.269	2.668,10	3.736,24
500	400	3	BBN00278551033000.	3.129	3.679,69	5.153,09
750	250	1	BBN00274751013000.	1.058	1.244,88	1.742,43
750	250	2	BBN00274751023000.	1.780	2.094,61	2.932,24
750	250	3	BBN00274751033000.	2.519	2.963,37	4.148,53
750	300	1	BBN00276751013000.	1.223	1.438,93	2.014,03
750	300	2	BBN00276751023000.	2.033	2.392,15	3.348,16
750	300	3	BBN00276751033000.	2.861	3.366,77	4.712,34
750	400	1	BBN00278751013000.	1.584	1.863,05	2.608,27
750	400	2	BBN00278751023000.	2.580	3.034,64	4.248,29
750	400	3	BBN00278751033000.	3.596	4.229,78	5.920,90
900	250	1	BBN00274951013000.	1.128	1.327,34	1.858,54
900	250	2	BBN00274951023000.	1.921	2.259,53	3.164,46
900	300	1	BBN00276951013000.	1.293	1.521,39	2.130,14
900	300	2	BBN00276951023000.	2.173	2.557,07	3.580,38
900	400	1	BBN00278951013000.	1.654	1.945,51	2.724,38
900	400	2	BBN00278951023000.	2.720	3.199,56	4.480,51
1000	250	1	BBN00274151013000.	1.173	1.379,48	1.931,69
1000	250	2	BBN00274151023000.	2.006	2.359,97	3.304,65
1000	300	1	BBN00276151013000.	1.339	1.576,20	2.206,35
1000	300	2	BBN00276151023000.	2.262	2.661,89	3.726,54
1000	400	1	BBN00278151013000.	1.702	2.002,45	2.803,78
1000	400	2	BBN00278151023000.	2.813	3.308,38	4.632,67

LINGO SHELVING SYSTEM

BBN002 - CROSS BRACE - ADJUSTABLE FEET - WITH OVERLAYING WOODEN TOP PLATE



LINGO SHELVING SYSTEM

BBN002 - CROSS BRACE - ADJUSTABLE FEET - WITH OVERLAYING WOODEN TOP PLATE

Shelving system with wooden panels, cross brace and overlaying top plate.
 Middle shelf must be screwed into panels for bays above H1220 mm.
 For configurations with more than 3 bays, please contact Customer Service.

- Prices based on steel price group 1 and wooden price group A (see Design Options pages 6-9).
- For shelves see page 144 & 166.
- For accessories see page 186.

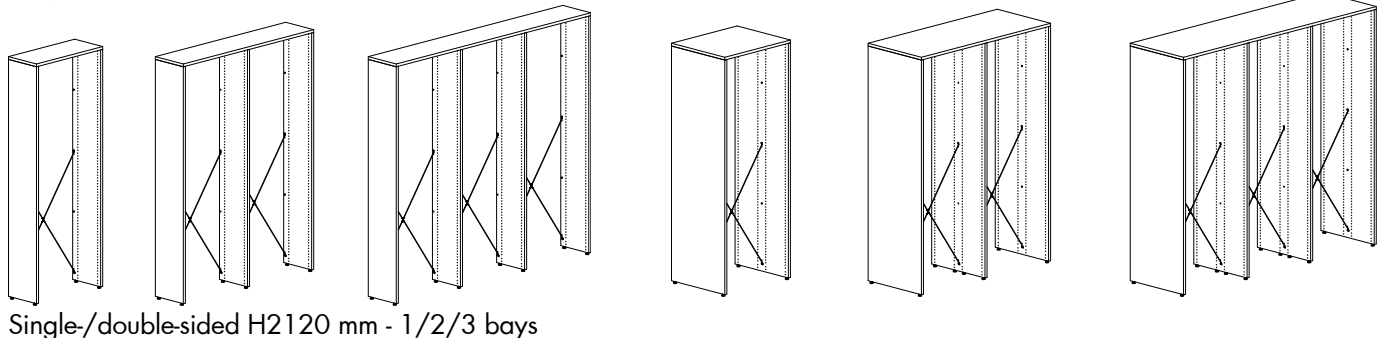
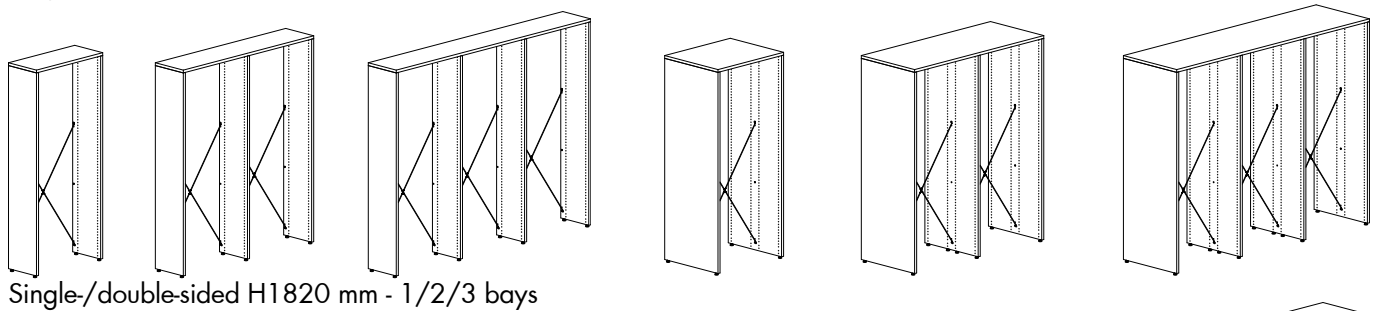
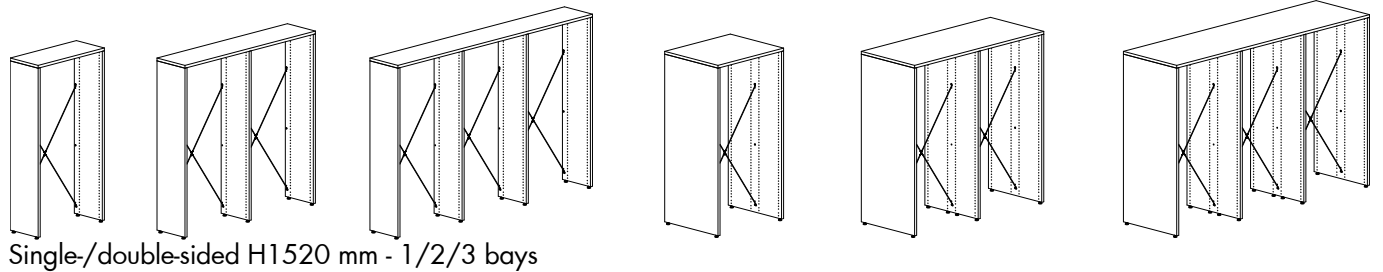
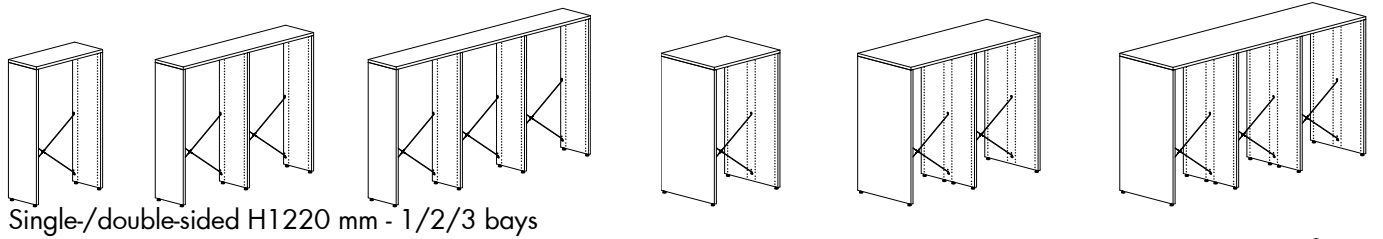
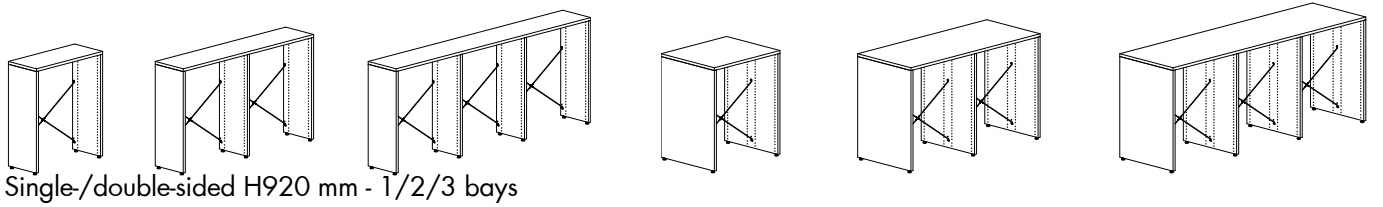
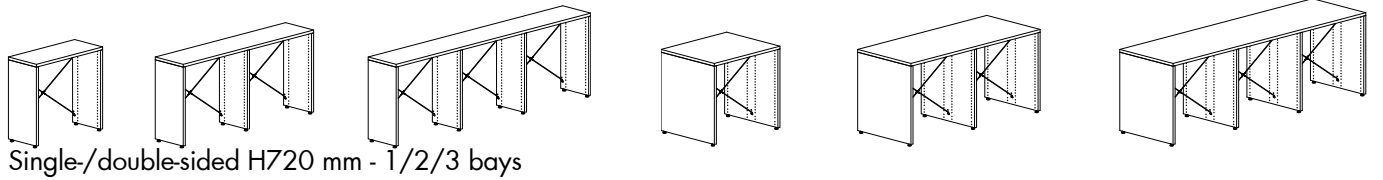

LINGO SHELVING SYSTEM

SINGLE-SIDED - CROSS BRACE - ADJUSTABLE FEET - WITH OVERLAYING WOODEN TOP PLATE

Painted and veneered Lingo Shelving Systems are FSC-certified. Configurations with more than 2/3 bays are available.

H720 mm

Module mm	Shelf depth mm	No. of bays	Item no.	Melamine EUR	Painted EUR	Veneer EUR
500	250	1	BBN00223551019000.	257	298,59	409,50
500	250	2	BBN00223551029000.	417	483,59	659,68
500	250	3	BBN00223551039000.	585	676,57	921,02
500	300	1	BBN00225551019000.	289	335,55	461,39
500	300	2	BBN00225551029000.	467	541,83	741,09
500	300	3	BBN00225551039000.	654	756,88	1.033,69
500	400	1	BBN00227551019000.	364	424,13	585,21
500	400	2	BBN00227551029000.	582	677,10	930,21
500	400	3	BBN00227551039000.	809	940,17	1.289,71
750	250	1	BBN00223751019000.	292	339,42	466,43
750	250	2	BBN00223751029000.	479	556,74	761,82
750	250	3	BBN00223751039000.	678	786,30	1.074,63
750	300	1	BBN00225751019000.	327	381,04	524,96
750	300	2	BBN00225751029000.	536	622,96	855,20
750	300	3	BBN00225751039000.	757	878,85	1.204,86
750	400	1	BBN00227751019000.	406	474,01	654,77
750	400	2	BBN00227751029000.	658	766,74	1.055,63
750	400	3	BBN00227751039000.	923	1.074,63	1.478,04
900	250	1	BBN00223951019000.	292	339,42	466,43
900	250	2	BBN00223951029000.	479	556,74	761,82
900	300	1	BBN00225951019000.	327	381,04	524,96
900	300	2	BBN00225951029000.	536	622,96	855,20
900	400	1	BBN00227951019000.	406	474,01	654,77
900	400	2	BBN00227951029000.	658	766,74	1.055,63
1000	250	1	BBN00223151019000.	303	353,12	485,58
1000	250	2	BBN00223151029000.	500	581,08	796,13
1000	300	1	BBN00225151019000.	340	396,07	545,97
1000	300	2	BBN00225151029000.	560	650,22	893,37
1000	400	1	BBN00227151019000.	420	490,50	678,17
1000	400	2	BBN00227151029000.	684	796,80	1.097,39

LINGO SHELVING SYSTEM

SINGLE-SIDED - CROSS BRACE - ADJUSTABLE FEET - WITH OVERLAYING WOODEN TOP PLATE

Painted and veneered Lingo Shelving Systems are FSC-certified. Configurations with more than 2/3 bays are available.

H920 mm

Module mm	Shelf depth mm	No. of bays	Item no.	Melamine EUR	Painted EUR	Veneer EUR
500	250	1	BBN00233551019000.	304	353,11	485,04
500	250	2	BBN00233551029000.	487	565,37	772,99
500	250	3	BBN00233551039000.	678	785,61	1.072,10
500	300	1	BBN00235551019000.	342	397,81	548,63
500	300	2	BBN00235551029000.	547	635,22	871,95
500	300	3	BBN00235551039000.	760	881,40	1.208,17
500	400	1	BBN00237551019000.	436	507,93	702,77
500	400	2	BBN00237551029000.	689	802,80	1.106,55
500	400	3	BBN00237551039000.	952	1.107,77	1.524,83
750	250	1	BBN00233751019000.	338	393,94	541,97
750	250	2	BBN00233751029000.	549	638,52	875,13
750	250	3	BBN00233751039000.	771	895,34	1.225,71
750	300	1	BBN00235751019000.	380	443,30	612,20
750	300	2	BBN00235751029000.	616	716,35	986,06
750	300	3	BBN00235751039000.	863	1.003,37	1.379,34
750	400	1	BBN00237751019000.	478	557,81	772,33
750	400	2	BBN00237751029000.	766	892,44	1.231,97
750	400	3	BBN00237751039000.	1.066	1.242,23	1.713,16
900	250	1	BBN00233951019000.	338	393,94	541,97
900	250	2	BBN00233951029000.	549	638,52	875,13
900	300	1	BBN00235951019000.	380	443,30	612,20
900	300	2	BBN00235951029000.	616	716,35	986,06
900	400	1	BBN00237951019000.	478	557,81	772,33
900	400	2	BBN00237951029000.	766	892,44	1.231,97
1000	250	1	BBN00233151019000.	350	407,64	561,12
1000	250	2	BBN00233151029000.	570	662,86	909,44
1000	300	1	BBN00235151019000.	393	458,33	633,21
1000	300	2	BBN00235151029000.	639	743,61	1.024,23
1000	400	1	BBN00237151019000.	492	574,30	795,73
1000	400	2	BBN00237151029000.	791	922,50	1.273,73

LINGO SHELVING SYSTEM

SINGLE-SIDED - CROSS BRACE - ADJUSTABLE FEET - WITH OVERLAYING WOODEN TOP PLATE

Painted and veneered Lingo Shelving Systems are FSC-certified. Configurations with more than 2/3 bays are available.

H1220 mm

Module mm	Shelf depth mm	No. of bays	Item no.	Melamine EUR	Painted EUR	Veneer EUR
500	250	1	BBN00243551019000.	372	433,45	598,62
500	250	2	BBN00243551029000.	590	685,88	943,36
500	250	3	BBN00243551039000.	815	946,29	1.299,26
500	300	1	BBN00245551019000.	392	457,13	630,83
500	300	2	BBN00245551029000.	622	724,20	995,25
500	300	3	BBN00245551039000.	860	1.000,04	1.372,57
500	400	1	BBN00247551019000.	532	621,51	861,31
500	400	2	BBN00247551029000.	834	973,17	1.344,36
500	400	3	BBN00247551039000.	1.145	1.334,93	1.841,91
750	250	1	BBN00243751019000.	407	474,28	655,55
750	250	2	BBN00243751029000.	652	759,03	1.045,50
750	250	3	BBN00243751039000.	908	1.056,02	1.452,87
750	300	1	BBN00245751019000.	431	502,62	694,40
750	300	2	BBN00245751029000.	691	805,33	1.109,36
750	300	3	BBN00245751039000.	964	1.122,01	1.543,74
750	400	1	BBN00247751019000.	574	671,39	930,87
750	400	2	BBN00247751029000.	910	1.062,81	1.469,78
750	400	3	BBN00247751039000.	1.259	1.469,39	2.030,24
900	250	1	BBN00243951019000.	407	474,28	655,55
900	250	2	BBN00243951029000.	652	759,03	1.045,50
900	300	1	BBN00245951019000.	431	502,62	694,40
900	300	2	BBN00245951029000.	691	805,33	1.109,36
900	400	1	BBN00247951019000.	574	671,39	930,87
900	400	2	BBN00247951029000.	910	1.062,81	1.469,78
1000	250	1	BBN00243151019000.	418	487,98	674,70
1000	250	2	BBN00243151029000.	673	783,37	1.079,81
1000	300	1	BBN00245151019000.	443	517,65	715,41
1000	300	2	BBN00245151029000.	714	832,59	1.147,53
1000	400	1	BBN00247151019000.	588	687,88	954,27
1000	400	2	BBN00247151029000.	936	1.092,87	1.511,54

LINGO SHELVING SYSTEM

SINGLE-SIDED - CROSS BRACE - ADJUSTABLE FEET - WITH OVERLAYING WOODEN TOP PLATE

Painted and veneered Lingo Shelving Systems are FSC-certified. Configurations with more than 2/3 bays are available.

H1520 mm

Module mm	Shelf depth mm	No. of bays	Item no.	Melamine EUR	Painted EUR	Veneer EUR
500	250	1	BBN00253551019000.	410	478,93	661,68
500	250	2	BBN00253551029000.	647	754,10	1.037,95
500	250	3	BBN00253551039000.	892	1.037,25	1.425,38
500	300	1	BBN00255551019000.	430	502,35	693,59
500	300	2	BBN00255551029000.	679	792,03	1.089,39
500	300	3	BBN00255551039000.	936	1.090,48	1.498,09
500	400	1	BBN00257551019000.	597	697,85	967,71
500	400	2	BBN00257551029000.	931	1.087,68	1.503,96
500	400	3	BBN00257551039000.	1.274	1.487,61	2.054,71
750	250	1	BBN00253751019000.	445	519,76	718,61
750	250	2	BBN00253751029000.	710	827,25	1.140,09
750	250	3	BBN00253751039000.	985	1.146,98	1.578,99
750	300	1	BBN00255751019000.	469	547,84	757,16
750	300	2	BBN00255751029000.	748	873,16	1.203,50
750	300	3	BBN00255751039000.	1.040	1.212,45	1.669,26
750	400	1	BBN00257751019000.	639	747,73	1.037,27
750	400	2	BBN00257751029000.	1.007	1.177,32	1.629,38
750	400	3	BBN00257751039000.	1.389	1.622,07	2.243,04
900	250	1	BBN00253951019000.	445	519,76	718,61
900	250	2	BBN00253951029000.	710	827,25	1.140,09
900	300	1	BBN00255951019000.	469	547,84	757,16
900	300	2	BBN00255951029000.	748	873,16	1.203,50
900	400	1	BBN00257951019000.	639	747,73	1.037,27
900	400	2	BBN00257951029000.	1.007	1.177,32	1.629,38
1000	250	1	BBN00253151019000.	457	533,46	737,76
1000	250	2	BBN00253151029000.	730	851,59	1.174,40
1000	300	1	BBN00255151019000.	481	562,87	778,17
1000	300	2	BBN00255151029000.	772	900,42	1.241,67
1000	400	1	BBN00257151019000.	653	764,22	1.060,67
1000	400	2	BBN00257151029000.	1.033	1.207,38	1.671,14

LINGO SHELVING SYSTEM

SINGLE-SIDED - CROSS BRACE - ADJUSTABLE FEET - WITH OVERLAYING WOODEN TOP PLATE

Painted and veneered Lingo Shelving Systems are FSC-certified. Configurations with more than 2/3 bays are available.

H1820 mm

Module mm	Shelf depth mm	No. of bays	Item no.	Melamine EUR	Painted EUR	Veneer EUR
500	250	1	BBN00263551019000.	466	543,57	752,38
500	250	2	BBN00263551029000.	730	851,06	1.174,00
500	250	3	BBN00263551039000.	1.002	1.166,53	1.606,78
500	300	1	BBN00265551019000.	482	562,99	778,71
500	300	2	BBN00265551029000.	757	882,99	1.217,07
500	300	3	BBN00265551039000.	1.040	1.211,76	1.668,33
500	400	1	BBN00267551019000.	667	780,83	1.085,01
500	400	2	BBN00267551029000.	1.037	1.212,15	1.679,91
500	400	3	BBN00267551039000.	1.415	1.653,57	2.289,31
750	250	1	BBN00263751019000.	500	584,40	809,31
750	250	2	BBN00263751029000.	792	924,21	1.276,14
750	250	3	BBN00263751039000.	1.095	1.276,26	1.760,39
750	300	1	BBN00265751019000.	520	608,48	842,28
750	300	2	BBN00265751029000.	826	964,12	1.331,18
750	300	3	BBN00265751039000.	1.144	1.333,73	1.839,50
750	400	1	BBN00267751019000.	709	830,71	1.154,57
750	400	2	BBN00267751029000.	1.113	1.301,79	1.805,33
750	400	3	BBN00267751039000.	1.530	1.788,03	2.477,64
900	250	1	BBN00263951019000.	500	584,40	809,31
900	250	2	BBN00263951029000.	792	924,21	1.276,14
900	300	1	BBN00265951019000.	520	608,48	842,28
900	300	2	BBN00265951029000.	826	964,12	1.331,18
900	400	1	BBN00267951019000.	709	830,71	1.154,57
900	400	2	BBN00267951029000.	1.113	1.301,79	1.805,33
1000	250	1	BBN00263151019000.	512	598,10	828,46
1000	250	2	BBN00263151029000.	813	948,55	1.310,45
1000	300	1	BBN00265151019000.	533	623,51	863,29
1000	300	2	BBN00265151029000.	849	991,38	1.369,35
1000	400	1	BBN00267151019000.	723	847,20	1.177,97
1000	400	2	BBN00267151029000.	1.139	1.331,85	1.847,09

LINGO SHELVING SYSTEM

SINGLE-SIDED - CROSS BRACE - ADJUSTABLE FEET - WITH OVERLAYING WOODEN TOP PLATE

Painted and veneered Lingo Shelving Systems are FSC-certified. Configurations with more than 2/3 bays are available.

H2120 mm

Module mm	Shelf depth mm	No. of bays	Item no.	Melamine EUR	Painted EUR	Veneer EUR
500	250	1	BBN00273551019000.	508	594,11	823,14
500	250	2	BBN00273551029000.	794	926,87	1.280,14
500	250	3	BBN00273551039000.	1.087	1.267,61	1.748,30
500	300	1	BBN00275551019000.	524	612,47	848,41
500	300	2	BBN00275551029000.	820	957,21	1.321,62
500	300	3	BBN00275551039000.	1.124	1.310,72	1.807,73
500	400	1	BBN00277551019000.	722	844,95	1.173,87
500	400	2	BBN00277551029000.	1.119	1.308,33	1.813,20
500	400	3	BBN00277551039000.	1.524	1.781,81	2.467,03
750	250	1	BBN00273751019000.	543	634,94	880,07
750	250	2	BBN00273751029000.	857	1.000,02	1.382,28
750	250	3	BBN00273751039000.	1.181	1.377,34	1.901,91
750	300	1	BBN00275751019000.	562	657,96	911,98
750	300	2	BBN00275751029000.	889	1.038,34	1.435,73
750	300	3	BBN00275751039000.	1.228	1.432,69	1.978,90
750	400	1	BBN00277751019000.	764	894,83	1.243,43
750	400	2	BBN00277751029000.	1.195	1.397,97	1.938,62
750	400	3	BBN00277751039000.	1.639	1.916,27	2.655,36
900	250	1	BBN00273951019000.	543	634,94	880,07
900	250	2	BBN00273951029000.	857	1.000,02	1.382,28
900	300	1	BBN00275951019000.	562	657,96	911,98
900	300	2	BBN00275951029000.	889	1.038,34	1.435,73
900	400	1	BBN00277951019000.	764	894,83	1.243,43
900	400	2	BBN00277951029000.	1.195	1.397,97	1.938,62
1000	250	1	BBN00273151019000.	554	648,64	899,22
1000	250	2	BBN00273151029000.	877	1.024,36	1.416,59
1000	300	1	BBN00275151019000.	575	672,99	932,99
1000	300	2	BBN00275151029000.	912	1.065,60	1.473,90
1000	400	1	BBN00277151019000.	778	911,32	1.266,83
1000	400	2	BBN00277151029000.	1.220	1.428,03	1.980,38

LINGO SHELVING SYSTEM

DOUBLE-SIDED - CROSS BRACE - ADJUSTABLE FEET - WITH OVERLAYING WOODEN TOP PLATE

Painted and veneered Lingo Shelving Systems are FSC-certified. Configurations with more than 2/3 bays are available.

H720 mm

Module mm	Shelf depth mm	No. of bays	Item no.	Melamine EUR	Painted EUR	Veneer EUR
500	250	1	BBN00224551019000.	371	432,25	595,96
500	250	2	BBN00224551029000.	599	696,79	957,59
500	250	3	BBN00224551039000.	838	974,22	1.337,43
500	300	1	BBN00226551019000.	458	534,92	740,28
500	300	2	BBN00226551029000.	734	855,05	1.179,84
500	300	3	BBN00226551039000.	1.021	1.189,41	1.639,35
500	400	1	BBN00228551019000.	614	718,19	996,83
500	400	2	BBN00228551029000.	971	1.134,35	1.570,32
500	400	3	BBN00228551039000.	1.341	1.565,93	2.165,89
750	250	1	BBN00224751019000.	424	495,16	683,88
750	250	2	BBN00224751029000.	695	809,70	1.115,72
750	250	3	BBN00224751039000.	982	1.143,27	1.574,04
750	300	1	BBN00226751019000.	518	604,61	837,90
750	300	2	BBN00226751029000.	840	980,34	1.355,27
750	300	3	BBN00226751039000.	1.181	1.377,47	1.902,69
750	400	1	BBN00228751019000.	679	794,93	1.104,16
750	400	2	BBN00228751029000.	1.088	1.272,13	1.763,43
750	400	3	BBN00228751039000.	1.517	1.772,88	2.455,29
900	250	1	BBN00224951019000.	424	495,16	683,88
900	250	2	BBN00224951029000.	695	809,70	1.115,72
900	300	1	BBN00226951019000.	518	604,61	837,90
900	300	2	BBN00226951029000.	840	980,34	1.355,27
900	400	1	BBN00228951019000.	679	794,93	1.104,16
900	400	2	BBN00228951029000.	1.088	1.272,13	1.763,43
1000	250	1	BBN00224151019000.	442	515,77	713,14
1000	250	2	BBN00224151029000.	727	847,08	1.168,13
1000	300	1	BBN00226151019000.	537	627,89	870,22
1000	300	2	BBN00226151029000.	876	1.022,10	1.413,65
1000	400	1	BBN00228151019000.	701	820,34	1.139,67
1000	400	2	BBN00228151029000.	1.127	1.317,89	1.827,81

LINGO SHELVING SYSTEM

DOUBLE-SIDED - CROSS BRACE - ADJUSTABLE FEET - WITH OVERLAYING WOODEN TOP PLATE

Painted and veneered Lingo Shelving Systems are FSC-certified. Configurations with more than 2/3 bays are available.

H920 mm

Module mm	Shelf depth mm	No. of bays	Item no.	Melamine EUR	Painted EUR	Veneer EUR
500	250	1	BBN00234551019000.	438	511,25	706,62
500	250	2	BBN00234551029000.	700	815,29	1.123,58
500	250	3	BBN00234551039000.	973	1.132,22	1.558,75
500	300	1	BBN00236551019000.	546	639,20	886,06
500	300	2	BBN00236551029000.	866	1.011,47	1.398,51
500	300	3	BBN00236551039000.	1.198	1.397,97	1.930,91
500	400	1	BBN00238551019000.	742	868,75	1.207,51
500	400	2	BBN00238551029000.	1.163	1.360,19	1.886,34
500	400	3	BBN00238551039000.	1.597	1.867,05	2.587,25
750	250	1	BBN00234751019000.	491	574,16	794,54
750	250	2	BBN00234751029000.	796	928,20	1.281,71
750	250	3	BBN00234751039000.	1.116	1.301,27	1.795,36
750	300	1	BBN00236751019000.	606	708,89	983,68
750	300	2	BBN00236751029000.	973	1.136,76	1.573,94
750	300	3	BBN00236751039000.	1.358	1.586,03	2.194,25
750	400	1	BBN00238751019000.	807	945,49	1.314,84
750	400	2	BBN00238751029000.	1.280	1.497,97	2.079,45
750	400	3	BBN00238751039000.	1.773	2.074,00	2.876,65
900	250	1	BBN00234951019000.	491	574,16	794,54
900	250	2	BBN00234951029000.	796	928,20	1.281,71
900	300	1	BBN00236951019000.	606	708,89	983,68
900	300	2	BBN00236951029000.	973	1.136,76	1.573,94
900	400	1	BBN00238951019000.	807	945,49	1.314,84
900	400	2	BBN00238951029000.	1.280	1.497,97	2.079,45
1000	250	1	BBN00234151019000.	509	594,77	823,80
1000	250	2	BBN00234151029000.	827	965,58	1.334,12
1000	300	1	BBN00236151019000.	626	732,17	1.016,00
1000	300	2	BBN00236151029000.	1.008	1.178,52	1.632,32
1000	400	1	BBN00238151019000.	829	970,90	1.350,35
1000	400	2	BBN00238151029000.	1.319	1.543,73	2.143,83

LINGO SHELVING SYSTEM

DOUBLE-SIDED - CROSS BRACE - ADJUSTABLE FEET - WITH OVERLAYING WOODEN TOP PLATE

Painted and veneered Lingo Shelving Systems are FSC-certified. Configurations with more than 2/3 bays are available.

H1220 mm

Module mm	Shelf depth mm	No. of bays	Item no.	Melamine EUR	Painted EUR	Veneer EUR
500	250	1	BBN00244551019000.	537	627,49	869,68
500	250	2	BBN00244551029000.	848	989,65	1.368,17
500	250	3	BBN00244551039000.	1.170	1.364,70	1.884,87
500	300	1	BBN00246551019000.	668	782,04	1.086,34
500	300	2	BBN00246551029000.	1.048	1.225,73	1.698,93
500	300	3	BBN00246551039000.	1.441	1.683,65	2.331,47
500	400	1	BBN00248551019000.	919	1.077,29	1.499,85
500	400	2	BBN00248551029000.	1.428	1.673,00	2.324,85
500	400	3	BBN00248551039000.	1.951	2.284,13	3.171,93
750	250	1	BBN00244751019000.	590	690,40	957,60
750	250	2	BBN00244751029000.	944	1.102,56	1.526,30
750	250	3	BBN00244751039000.	1.314	1.533,75	2.121,48
750	300	1	BBN00246751019000.	728	851,73	1.183,96
750	300	2	BBN00246751029000.	1.155	1.351,02	1.874,36
750	300	3	BBN00246751039000.	1.601	1.871,71	2.594,81
750	400	1	BBN00248751019000.	984	1.154,03	1.607,18
750	400	2	BBN00248751029000.	1.546	1.810,78	2.517,96
750	400	3	BBN00248751039000.	2.127	2.491,08	3.461,33
900	250	1	BBN00244951019000.	590	690,40	957,60
900	250	2	BBN00244951029000.	944	1.102,56	1.526,30
900	300	1	BBN00246951019000.	728	851,73	1.183,96
900	300	2	BBN00246951029000.	1.155	1.351,02	1.874,36
900	400	1	BBN00248951019000.	984	1.154,03	1.607,18
900	400	2	BBN00248951029000.	1.546	1.810,78	2.517,96
1000	250	1	BBN00244151019000.	608	711,01	986,86
1000	250	2	BBN00244151029000.	975	1.139,94	1.578,71
1000	300	1	BBN00246151019000.	747	875,01	1.216,28
1000	300	2	BBN00246151029000.	1.190	1.392,78	1.932,74
1000	400	1	BBN00248151019000.	1.006	1.179,44	1.642,69
1000	400	2	BBN00248151029000.	1.585	1.856,54	2.582,34

LINGO SHELVING SYSTEM

DOUBLE-SIDED - CROSS BRACE - ADJUSTABLE FEET - WITH OVERLAYING WOODEN TOP PLATE

Painted and veneered Lingo Shelving Systems are FSC-certified. Configurations with more than 2/3 bays are available.

H1520 mm

Module mm	Shelf depth mm	No. of bays	Item no.	Melamine EUR	Painted EUR	Veneer EUR
500	250	1	BBN00254551019000.	584	683,35	947,08
500	250	2	BBN00254551029000.	919	1.073,44	1.484,27
500	250	3	BBN00254551039000.	1.265	1.476,42	2.039,67
500	300	1	BBN00256551019000.	696	815,28	1.132,90
500	300	2	BBN00256551029000.	1.091	1.275,59	1.768,77
500	300	3	BBN00256551039000.	1.497	1.750,13	2.424,59
500	400	1	BBN00258551019000.	959	1.124,91	1.566,07
500	400	2	BBN00258551029000.	1.489	1.744,43	2.424,18
500	400	3	BBN00258551039000.	2.032	2.379,37	3.304,37
750	250	1	BBN00254751019000.	637	746,26	1.035,00
750	250	2	BBN00254751029000.	1.015	1.186,35	1.642,40
750	250	3	BBN00254751039000.	1.409	1.645,47	2.276,28
750	300	1	BBN00256751019000.	756	884,97	1.230,52
750	300	2	BBN00256751029000.	1.197	1.400,88	1.944,20
750	300	3	BBN00256751039000.	1.657	1.938,19	2.687,93
750	400	1	BBN00258751019000.	1.025	1.201,65	1.673,40
750	400	2	BBN00258751029000.	1.606	1.882,21	2.617,29
750	400	3	BBN00258751039000.	2.208	2.586,32	3.593,77
900	250	1	BBN00254951019000.	637	746,26	1.035,00
900	250	2	BBN00254951029000.	1.015	1.186,35	1.642,40
900	300	1	BBN00256951019000.	756	884,97	1.230,52
900	300	2	BBN00256951029000.	1.197	1.400,88	1.944,20
900	400	1	BBN00258951019000.	1.025	1.201,65	1.673,40
900	400	2	BBN00258951029000.	1.606	1.882,21	2.617,29
1000	250	1	BBN00254151019000.	655	766,87	1.064,26
1000	250	2	BBN00254151029000.	1.047	1.223,73	1.694,81
1000	300	1	BBN00256151019000.	775	908,25	1.262,84
1000	300	2	BBN00256151029000.	1.233	1.442,64	2.002,58
1000	400	1	BBN00258151019000.	1.046	1.227,06	1.708,91
1000	400	2	BBN00258151029000.	1.645	1.927,97	2.681,67

LINGO SHELVING SYSTEM

DOUBLE-SIDED - CROSS BRACE - ADJUSTABLE FEET - WITH OVERLAYING WOODEN TOP PLATE

Painted and veneered Lingo Shelving Systems are FSC-certified. Configurations with more than 2/3 bays are available.

H1820 mm

Module mm	Shelf depth mm	No. of bays	Item no.	Melamine EUR	Painted EUR	Veneer EUR
500	250	1	BBN00264551019000.	666	779,65	1.083,02
500	250	2	BBN00264551029000.	1.042	1.217,89	1.688,18
500	250	3	BBN00264551039000.	1.428	1.669,02	2.311,55
500	300	1	BBN00266551019000.	797	934,20	1.298,62
500	300	2	BBN00266551029000.	1.242	1.453,97	2.017,35
500	300	3	BBN00266551039000.	1.699	1.987,97	2.756,03
500	400	1	BBN00268551019000.	1.107	1.298,87	1.810,27
500	400	2	BBN00268551029000.	1.711	2.005,37	2.790,48
500	400	3	BBN00268551039000.	2.328	2.727,29	3.792,77
750	250	1	BBN00264751019000.	719	842,56	1.170,94
750	250	2	BBN00264751029000.	1.138	1.330,80	1.846,31
750	250	3	BBN00264751039000.	1.572	1.838,07	2.548,16
750	300	1	BBN00266751019000.	857	1.003,89	1.396,24
750	300	2	BBN00266751029000.	1.348	1.579,26	2.192,78
750	300	3	BBN00266751039000.	1.859	2.176,03	3.019,37
750	400	1	BBN00268751019000.	1.173	1.375,61	1.917,60
750	400	2	BBN00268751029000.	1.828	2.143,15	2.983,59
750	400	3	BBN00268751039000.	2.504	2.934,24	4.082,17
900	250	1	BBN00264951019000.	719	842,56	1.170,94
900	250	2	BBN00264951029000.	1.138	1.330,80	1.846,31
900	300	1	BBN00266951019000.	857	1.003,89	1.396,24
900	300	2	BBN00266951029000.	1.348	1.579,26	2.192,78
900	400	1	BBN00268951019000.	1.173	1.375,61	1.917,60
900	400	2	BBN00268951029000.	1.828	2.143,15	2.983,59
1000	250	1	BBN00264151019000.	737	863,17	1.200,20
1000	250	2	BBN00264151029000.	1.169	1.368,18	1.898,72
1000	300	1	BBN00266151019000.	876	1.027,17	1.428,56
1000	300	2	BBN00266151029000.	1.384	1.621,02	2.251,16
1000	400	1	BBN00268151019000.	1.194	1.401,02	1.953,11
1000	400	2	BBN00268151029000.	1.867	2.188,91	3.047,97

LINGO SHELVING SYSTEM

DOUBLE-SIDED - CROSS BRACE - ADJUSTABLE FEET - WITH OVERLAYING WOODEN TOP PLATE

Painted and veneered Lingo Shelving Systems are FSC-certified. Configurations with more than 2/3 bays are available.

H2120 mm

Module mm	Shelf depth mm	No. of bays	Item no.	Melamine EUR	Painted EUR	Veneer EUR
500	250	1	BBN00274551019000.	736	861,31	1.197,12
500	250	2	BBN00274551029000.	1.146	1.340,38	1.859,33
500	250	3	BBN00274551039000.	1.568	1.832,34	2.539,75
500	300	1	BBN00276551019000.	894	1.048,58	1.459,02
500	300	2	BBN00276551029000.	1.388	1.625,54	2.257,95
500	300	3	BBN00276551039000.	1.894	2.216,73	3.076,83
500	400	1	BBN00278551019000.	1.250	1.465,65	2.043,55
500	400	2	BBN00278551029000.	1.924	2.255,54	3.140,40
500	400	3	BBN00278551039000.	2.613	3.060,85	4.259,33
750	250	1	BBN00274751019000.	789	924,22	1.285,04
750	250	2	BBN00274751029000.	1.242	1.453,29	2.017,46
750	250	3	BBN00274751039000.	1.711	2.001,39	2.776,36
750	300	1	BBN00276751019000.	954	1.118,27	1.556,64
750	300	2	BBN00276751029000.	1.495	1.750,83	2.433,38
750	300	3	BBN00276751039000.	2.054	2.404,79	3.340,17
750	400	1	BBN00278751019000.	1.315	1.542,39	2.150,88
750	400	2	BBN00278751029000.	2.042	2.393,32	3.333,51
750	400	3	BBN00278751039000.	2.789	3.267,80	4.548,73
900	250	1	BBN00274951019000.	789	924,22	1.285,04
900	250	2	BBN00274951029000.	1.242	1.453,29	2.017,46
900	300	1	BBN00276951019000.	954	1.118,27	1.556,64
900	300	2	BBN00276951029000.	1.495	1.750,83	2.433,38
900	400	1	BBN00278951019000.	1.315	1.542,39	2.150,88
900	400	2	BBN00278951029000.	2.042	2.393,32	3.333,51
1000	250	1	BBN00274151019000.	807	944,83	1.314,30
1000	250	2	BBN00274151029000.	1.274	1.490,67	2.069,87
1000	300	1	BBN00276151019000.	973	1.141,55	1.588,96
1000	300	2	BBN00276151029000.	1.530	1.792,59	2.491,76
1000	400	1	BBN00278151019000.	1.336	1.567,80	2.186,39
1000	400	2	BBN00278151029000.	2.081	2.439,08	3.397,89

LINGO SHELVING SYSTEM

BBN011 - STEEL BACK FRAME - CASTOR PLATE - FOR TOP SHELF



LINGO SHELVING SYSTEM

BBN011 - STEEL BACK FRAME - CASTOR PLATE - FOR TOP SHELF

Shelving system with wooden panels, metal back frame and castor plate.
To be used with top shelf.

- Prices based on steel price group 1 and wooden price group A (see Design Options pages 6-9).
- For top shelves, see pages 156 & 174
- For shelves see page 144 & 166.
- For accessories see page 186.

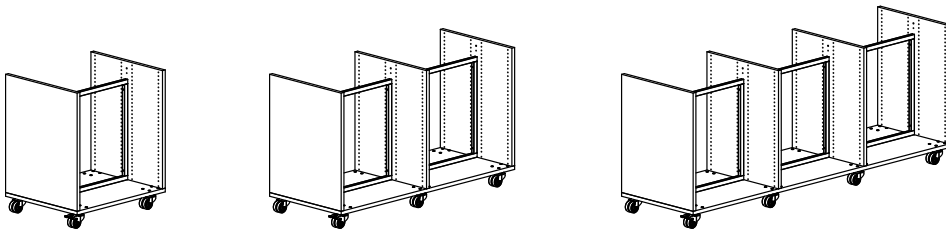

Double-sided H920 mm - 1/2/3 bays

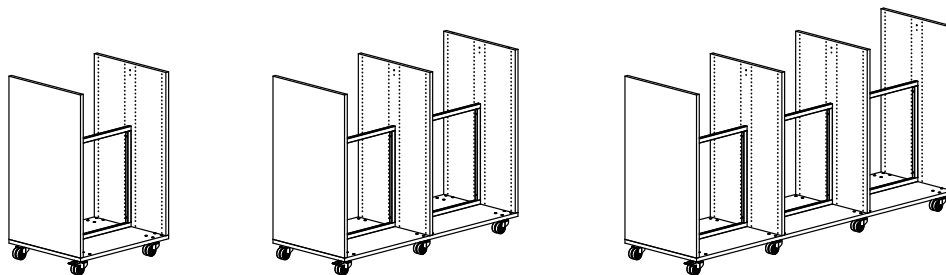

Double-sided H1220 mm - 1/2/3 bays

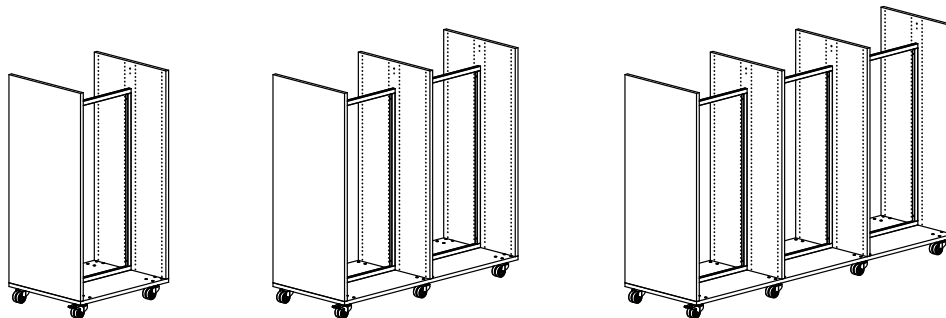

Double-sided H1520 mm - 1/2/3 bays

LINGO SHELVING SYSTEM

DOUBLE-SIDED - STEEL BACK FRAME - CASTOR PLATE - FOR TOP SHELF

Painted and veneered Lingo Shelving Systems are FSC-certified.

H920 mm

Module mm	Shelf depth mm	No. of bays	Item no.	Melamine EUR	Painted EUR	Veneer EUR
500	250	1	BBN011345016000.	562,99	648,10	875,53
500	250	2	BBN011345026000.	884,19	1.011,99	1.353,13
500	250	3	BBN011345036000.	1.249,14	1.427,08	1.901,88
500	300	1	BBN011365016000.	678,83	784,70	1.067,20
500	300	2	BBN011365026000.	1.058,41	1.217,35	1.640,56
500	300	3	BBN011365036000.	1.486,27	1.706,52	2.293,46
500	400	1	BBN011385016000.	882,18	1.023,43	1.400,62
500	400	2	BBN011385026000.	1.363,11	1.574,98	2.141,03
500	400	3	BBN011385036000.	1.897,37	2.189,03	2.968,95
750	250	1	BBN011347016000.	649,71	750,25	1.018,64
750	250	2	BBN011347026000.	1.014,66	1.165,34	1.567,39
750	250	3	BBN011347036000.	1.444,65	1.657,17	2.223,88
750	300	1	BBN011367016000.	775,52	898,55	1.226,13
750	300	2	BBN011367026000.	1.203,38	1.387,72	1.879,03
750	300	3	BBN011367036000.	1.703,60	1.962,15	2.651,50
750	400	1	BBN011387016000.	988,32	1.148,32	1.575,65
750	400	2	BBN011387026000.	1.522,58	1.762,37	2.403,57
750	400	3	BBN011387036000.	2.136,10	2.470,33	3.362,50
900	250	1	BBN011349016000.	701,98	811,83	1.104,43
900	250	2	BBN011349026000.	1.092,87	1.257,37	1.696,54
900	300	1	BBN011369016000.	833,51	966,65	1.321,36
900	300	2	BBN011369026000.	1.290,23	1.490,00	2.022,27
900	400	1	BBN011389016000.	1.051,89	1.223,06	1.680,85
900	400	2	BBN011389026000.	1.618,07	1.874,89	2.560,91
1000	250	1	BBN011341016000.	747,33	863,17	1.172,12
1000	250	2	BBN011341026000.	1.166,28	1.340,10	1.803,73
1000	300	1	BBN011361016000.	882,86	1.022,77	1.395,44
1000	300	2	BBN011361026000.	1.369,24	1.579,38	2.138,92
1000	400	1	BBN011381016000.	1.104,96	1.283,71	1.761,18
1000	400	2	BBN011381026000.	1.703,06	1.971,18	2.686,99

LINGO SHELVING SYSTEM

DOUBLE-SIDED - STEEL BACK FRAME - CASTOR PLATE - FOR TOP SHELF

Painted and veneered Lingo Shelving Systems are FSC-certified.

H1220 mm

Module mm	Shelf depth mm	No. of bays	Item no.	Melamine EUR	Painted EUR	Veneer EUR
500	250	1	BBN011445016000.	661,67	764,34	1.038,59
500	250	2	BBN011445026000.	1.032,21	1.186,35	1.597,72
500	250	3	BBN011445036000.	1.446,50	1.659,56	2.228,00
500	300	1	BBN011465016000.	800,39	927,54	1.267,48
500	300	2	BBN011465026000.	1.240,75	1.431,61	1.940,98
500	300	3	BBN011465036000.	1.729,39	1.992,20	2.694,02
500	400	1	BBN011485016000.	1.059,08	1.231,97	1.692,96
500	400	2	BBN011485026000.	1.628,46	1.887,79	2.579,54
500	400	3	BBN011485036000.	2.251,17	2.606,11	3.553,63
750	250	1	BBN011447016000.	748,39	866,49	1.181,70
750	250	2	BBN011447026000.	1.162,68	1.339,70	1.811,98
750	250	3	BBN011447036000.	1.642,01	1.889,65	2.550,00
750	300	1	BBN011467016000.	897,08	1.041,39	1.426,41
750	300	2	BBN011467026000.	1.385,72	1.601,98	2.179,45
750	300	3	BBN011467036000.	1.946,72	2.247,83	3.052,06
750	400	1	BBN011487016000.	1.165,22	1.356,86	1.867,99
750	400	2	BBN011487026000.	1.787,93	2.075,18	2.842,08
750	400	3	BBN011487036000.	2.489,90	2.887,41	3.947,18
900	250	1	BBN011449016000.	800,66	928,07	1.267,49
900	250	2	BBN011449026000.	1.240,89	1.431,73	1.941,13
900	300	1	BBN011469016000.	955,07	1.109,49	1.521,64
900	300	2	BBN011469026000.	1.472,57	1.704,26	2.322,69
900	400	1	BBN011489016000.	1.228,79	1.431,60	1.973,19
900	400	2	BBN011489026000.	1.883,42	2.187,70	2.999,42
1000	250	1	BBN011441016000.	846,01	979,41	1.335,18
1000	250	2	BBN011441026000.	1.314,30	1.514,46	2.048,32
1000	300	1	BBN011461016000.	1.004,42	1.165,61	1.595,72
1000	300	2	BBN011461026000.	1.551,58	1.793,64	2.439,34
1000	400	1	BBN011481016000.	1.281,86	1.492,25	2.053,52
1000	400	2	BBN011481026000.	1.968,41	2.283,99	3.125,50

LINGO SHELVING SYSTEM

DOUBLE-SIDED - STEEL BACK FRAME - CASTOR PLATE - FOR TOP SHELF

Painted and veneered Lingo Shelving Systems are FSC-certified.

H1520 mm

Module mm	Shelf depth mm	No. of bays	Item no.	Melamine EUR	Painted EUR	Veneer EUR
500	250	1	BBN011545016000.	733,23	844,14	1.139,93
500	250	2	BBN011545026000.	1.151,52	1.318,02	1.761,70
500	250	3	BBN011545036000.	1.613,56	1.843,10	2.454,62
500	300	1	BBN011565016000.	852,53	984,72	1.337,98
500	300	2	BBN011565026000.	1.330,93	1.529,35	2.058,70
500	300	3	BBN011565036000.	1.857,61	2.130,50	2.858,96
500	400	1	BBN011585016000.	1.123,44	1.303,53	1.783,12
500	400	2	BBN011585026000.	1.736,97	2.007,10	2.726,75
500	400	3	BBN011585036000.	2.403,83	2.773,17	3.757,89
750	250	1	BBN011547016000.	819,95	946,29	1.283,04
750	250	2	BBN011547026000.	1.281,99	1.471,37	1.975,96
750	250	3	BBN011547036000.	1.809,07	2.073,19	2.776,62
750	300	1	BBN011567016000.	949,22	1.098,57	1.496,91
750	300	2	BBN011567026000.	1.475,90	1.699,72	2.297,17
750	300	3	BBN011567036000.	2.074,94	2.386,13	3.217,00
750	400	1	BBN011587016000.	1.229,58	1.428,42	1.958,15
750	400	2	BBN011587026000.	1.896,44	2.194,49	2.989,29
750	400	3	BBN011587036000.	2.642,56	3.054,47	4.151,44
900	250	1	BBN011549016000.	872,22	1.007,87	1.368,83
900	250	2	BBN011549026000.	1.360,20	1.563,40	2.105,11
900	300	1	BBN011569016000.	1.007,21	1.166,67	1.592,14
900	300	2	BBN011569026000.	1.562,75	1.802,00	2.440,41
900	400	1	BBN011589016000.	1.293,15	1.503,16	2.063,35
900	400	2	BBN011589026000.	1.991,93	2.307,01	3.146,63
1000	250	1	BBN011541016000.	920,50	1.062,14	1.439,45
1000	250	2	BBN011541026000.	1.439,47	1.651,99	2.218,16
1000	300	1	BBN011561016000.	1.059,49	1.225,72	1.669,15
1000	300	2	BBN011561026000.	1.647,62	1.897,24	2.562,92
1000	400	1	BBN011581016000.	1.349,15	1.566,74	2.146,61
1000	400	2	BBN011581026000.	2.082,78	2.409,16	3.278,57



LINGO SHELVING SYSTEM

BBN011 - HIGH WOODEN BACK PANEL - CASTOR PLATE - FOR TOP SHELF



LINGO SHELVING SYSTEM

BBN011 - HIGH WOODEN BACK PANEL - CASTOR PLATE - FOR TOP SHELF

Shelving system with wooden panels, wooden back panel and castor plate.
To be used with ST1 standard depth, ST1 double-sided, ST2, ST3 and WT1 standard depth top shelf.

- Prices based on steel price group 1 and wooden price group A (see Design Options pages 6-9).
- For top shelves, see pages 156 & 174
- For shelves see page 144 & 166.
- For accessories see page 186.

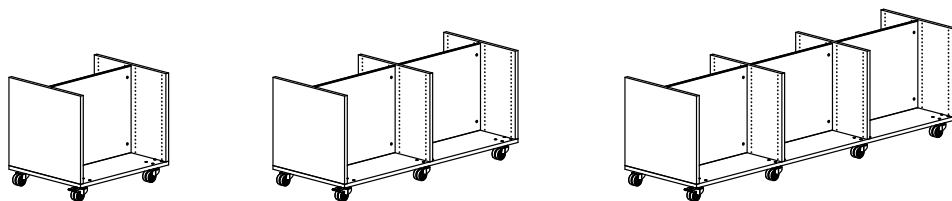

Double-sided H720 mm - 1/2/3 bays

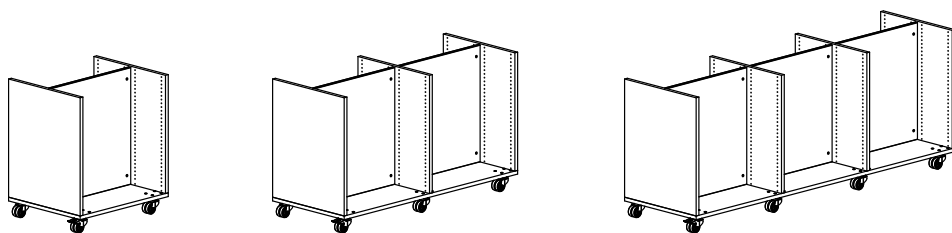

Double-sided H920 mm - 1/2/3 bays

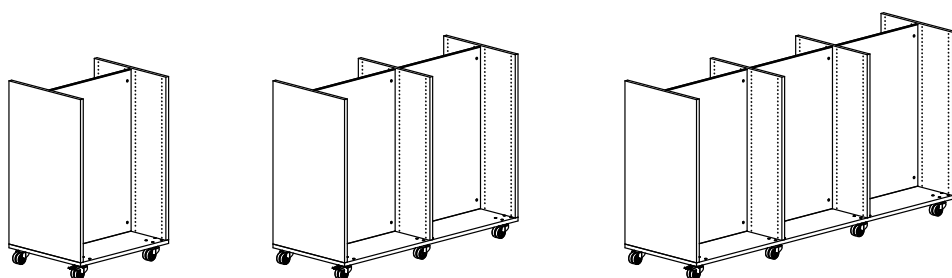

Double-sided H1220 mm - 1/2/3 bays

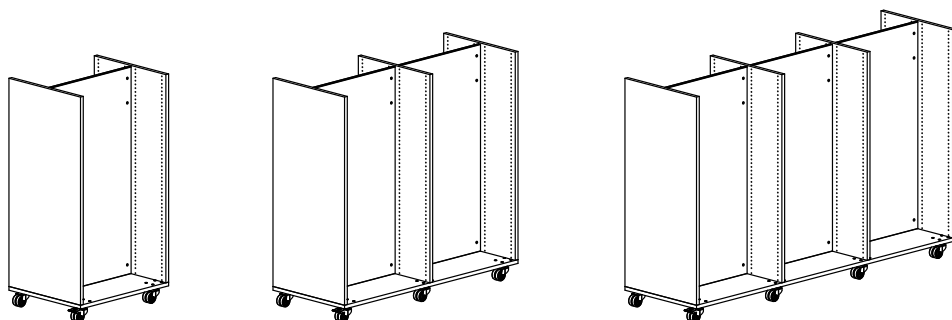

Double-sided H1520 mm - 1/2/3 bays

LINGO SHELVING SYSTEM

DOUBLE-SIDED - HIGH WOODEN BACK PANEL - CASTOR PLATE - FOR TOP SHELF

Painted and veneered Lingo Shelving Systems are FSC-certified.

H720 mm

Module mm	Shelf depth mm	No. of bays	Item no.	Melamine EUR	Painted EUR	Veneer EUR
500	250	1	BBN0112450120006	485,45	570,70	799,32
500	250	2	BBN0112450220006	762,63	896,69	1.256,04
500	250	3	BBN0112450320006	1.083,56	1.273,88	1.783,91
500	300	1	BBN0112650120006	580,01	682,02	955,87
500	300	2	BBN0112650220006	904,93	1.064,13	1.490,79
500	300	3	BBN0112650320006	1.278,13	1.502,76	2.105,25
500	400	1	BBN0112850120006	743,48	874,47	1.224,39
500	400	2	BBN0112850220006	1.149,81	1.352,34	1.893,91
500	400	3	BBN0112850320006	1.609,47	1.892,71	2.650,94
750	250	1	BBN0112470120006	606,75	713,81	999,89
750	250	2	BBN0112470220006	962,26	1.131,96	1.585,22
750	250	3	BBN0112470320006	1.382,81	1.626,85	2.278,29
750	300	1	BBN0112670120006	711,28	836,83	1.172,26
750	300	2	BBN0112670220006	1.119,06	1.316,42	1.844,18
750	300	3	BBN0112670320006	1.599,20	1.881,27	2.635,67
750	400	1	BBN0112870120006	884,20	1.040,32	1.456,88
750	400	2	BBN0112870220006	1.378,44	1.621,65	2.271,37
750	400	3	BBN0112870320006	1.951,94	2.296,89	3.216,87
900	250	1	BBN0112490120006	685,08	805,85	1.128,10
900	250	2	BBN0112490220006	1.092,59	1.284,91	1.799,21
900	300	1	BBN0112690120006	795,33	935,39	1.309,91
900	300	2	BBN0112690220006	1.258,03	1.479,62	2.072,26
900	400	1	BBN0112890120006	973,83	1.145,52	1.604,50
900	400	2	BBN0112890220006	1.526,05	1.795,09	2.513,55
1000	250	1	BBN0112410120006	728,44	856,92	1.199,38
1000	250	2	BBN0112410220006	1.162,02	1.367,10	1.913,58
1000	300	1	BBN0112610120006	842,69	991,24	1.387,58
1000	300	2	BBN0112610220006	1.333,06	1.568,46	2.196,09
1000	400	1	BBN0112810120006	1.024,91	1.205,90	1.688,42
1000	400	2	BBN0112810220006	1.607,06	1.890,84	2.646,81

LINGO SHELVING SYSTEM

DOUBLE-SIDED - HIGH WOODEN BACK PANEL - CASTOR PLATE - FOR TOP SHELF

Painted and veneered Lingo Shelving Systems are FSC-certified.

H920 mm

Module mm	Shelf depth mm	No. of bays	Item no.	Melamine EUR	Painted EUR	Veneer EUR
500	250	1	BBN0113450120006	571,77	672,58	942,03
500	250	2	BBN0113450220006	901,75	1.060,95	1.486,13
500	250	3	BBN0113450320006	1.275,48	1.500,52	2.101,38
500	300	1	BBN0113650120006	687,61	809,18	1.133,70
500	300	2	BBN0113650220006	1.075,97	1.266,31	1.773,56
500	300	3	BBN0113650320006	1.512,61	1.779,96	2.492,96
500	400	1	BBN0113850120006	890,96	1.047,91	1.467,12
500	400	2	BBN0113850220006	1.380,67	1.623,94	2.274,03
500	400	3	BBN0113850320006	1.923,71	2.262,47	3.168,45
750	250	1	BBN0113470120006	702,91	826,86	1.158,03
750	250	2	BBN0113470220006	1.121,06	1.318,56	1.846,17
750	250	3	BBN0113470320006	1.604,25	1.887,00	2.642,05
750	300	1	BBN0113670120006	828,72	975,16	1.365,52
750	300	2	BBN0113670220006	1.309,78	1.540,94	2.157,81
750	300	3	BBN0113670320006	1.863,20	2.191,98	3.069,67
750	400	1	BBN0113870120006	1.041,52	1.224,93	1.715,04
750	400	2	BBN0113870220006	1.628,98	1.915,59	2.682,35
750	400	3	BBN0113870320006	2.295,70	2.700,16	3.780,67
900	250	1	BBN0113490120006	788,43	927,68	1.298,61
900	250	2	BBN0113490220006	1.265,77	1.489,07	2.084,90
900	300	1	BBN0113690120006	919,96	1.082,50	1.515,54
900	300	2	BBN0113690220006	1.463,13	1.721,70	2.410,63
900	400	1	BBN0113890120006	1.138,34	1.338,91	1.875,03
900	400	2	BBN0113890220006	1.790,97	2.106,59	2.949,27
1000	250	1	BBN0113410120006	834,18	981,28	1.373,35
1000	250	2	BBN0113410220006	1.339,98	1.576,32	2.206,19
1000	300	1	BBN0113610120006	969,71	1.140,88	1.596,67
1000	300	2	BBN0113610220006	1.542,94	1.815,60	2.541,38
1000	400	1	BBN0113810120006	1.191,81	1.401,82	1.962,41
1000	400	2	BBN0113810220006	1.876,76	2.207,40	3.089,45

LINGO SHELVING SYSTEM

DOUBLE-SIDED - HIGH WOODEN BACK PANEL - CASTOR PLATE - FOR TOP SHELF

Painted and veneered Lingo Shelving Systems are FSC-certified.

H1220 mm

Module mm	Shelf depth mm	No. of bays	Item no.	Melamine EUR	Painted EUR	Veneer EUR
500	250	1	BBN0114450120006	700,11	823,79	1.153,90
500	250	2	BBN0114450220006	1.109,09	1.305,25	1.828,34
500	250	3	BBN0114450320006	1.561,82	1.837,91	2.573,93
500	300	1	BBN0114650120006	838,83	986,99	1.382,79
500	300	2	BBN0114650220006	1.317,63	1.550,51	2.171,60
500	300	3	BBN0114650320006	1.844,71	2.170,55	3.039,95
500	400	1	BBN0114850120006	1.097,52	1.291,42	1.808,27
500	400	2	BBN0114850220006	1.705,34	2.006,69	2.810,16
500	400	3	BBN0114850320006	2.366,49	2.784,46	3.899,56
750	250	1	BBN0114470120006	846,41	995,77	1.394,50
750	250	2	BBN0114470220006	1.358,72	1.598,26	2.237,58
750	250	3	BBN0114470320006	1.936,07	2.277,49	3.188,40
750	300	1	BBN0114670120006	995,10	1.170,67	1.639,21
750	300	2	BBN0114670220006	1.581,76	1.860,54	2.605,05
750	300	3	BBN0114670320006	2.240,78	2.635,67	3.690,46
750	400	1	BBN0114870120006	1.263,24	1.486,14	2.080,79
750	400	2	BBN0114870220006	1.983,97	2.333,74	3.267,68
750	400	3	BBN0114870320006	2.783,96	3.275,25	4.585,58
900	250	1	BBN0114490120006	935,26	1.100,57	1.541,21
900	250	2	BBN0114490220006	1.510,09	1.776,73	2.488,57
900	300	1	BBN0114690120006	1.089,67	1.281,99	1.795,36
900	300	2	BBN0114690220006	1.741,77	2.049,26	2.870,13
900	400	1	BBN0114890120006	1.363,39	1.604,10	2.246,91
900	400	2	BBN0114890220006	2.152,62	2.532,70	3.546,86
1000	250	1	BBN0114410120006	992,18	1.167,34	1.634,30
1000	250	2	BBN0114410220006	1.606,64	1.890,32	2.646,56
1000	300	1	BBN0114610120006	1.150,59	1.353,54	1.894,84
1000	300	2	BBN0114610220006	1.843,92	2.169,50	3.037,58
1000	400	1	BBN0114810120006	1.428,03	1.680,18	2.352,64
1000	400	2	BBN0114810220006	2.260,75	2.659,85	3.723,74

LINGO SHELVING SYSTEM

DOUBLE-SIDED - HIGH WOODEN BACK PANEL - CASTOR PLATE - FOR TOP SHELF

Painted and veneered Lingo Shelving Systems are FSC-certified.

H1520 mm

Module mm	Shelf depth mm	No. of bays	Item no.	Melamine EUR	Painted EUR	Veneer EUR
500	250	1	BBN0115450120006	774,33	910,78	1.274,93
500	250	2	BBN0115450220006	1.233,72	1.451,30	2.031,70
500	250	3	BBN0115450320006	1.736,86	2.043,02	2.859,62
500	300	1	BBN0115650120006	893,63	1.051,36	1.472,98
500	300	2	BBN0115650220006	1.413,13	1.662,63	2.328,70
500	300	3	BBN0115650320006	1.980,91	2.330,42	3.263,96
500	400	1	BBN0115850120006	1.164,54	1.370,17	1.918,12
500	400	2	BBN0115850220006	1.819,17	2.140,38	2.996,75
500	400	3	BBN0115850320006	2.527,13	2.973,09	4.162,89
750	250	1	BBN0115470120006	933,54	1.098,31	1.537,34
750	250	2	BBN0115470220006	1.509,17	1.775,41	2.484,56
750	250	3	BBN0115470320006	2.149,84	2.529,25	3.539,52
750	300	1	BBN0115670120006	1.062,81	1.250,59	1.751,21
750	300	2	BBN0115670220006	1.703,08	2.003,76	2.805,77
750	300	3	BBN0115670320006	2.415,71	2.842,19	3.979,90
750	400	1	BBN0115870120006	1.343,17	1.580,44	2.212,45
750	400	2	BBN0115870220006	2.123,62	2.498,53	3.497,89
750	400	3	BBN0115870320006	2.983,33	3.510,53	4.914,34
900	250	1	BBN0115490120006	1.034,22	1.216,82	1.703,20
900	250	2	BBN0115490220006	1.684,20	1.981,30	2.773,85
900	300	1	BBN0115690120006	1.169,21	1.375,62	1.926,51
900	300	2	BBN0115690220006	1.886,75	2.219,90	3.109,15
900	400	1	BBN0115890120006	1.455,15	1.712,11	2.397,72
900	400	2	BBN0115890220006	2.315,93	2.724,91	3.815,37
1000	250	1	BBN0115410120006	1.093,40	1.286,38	1.799,88
1000	250	2	BBN0115410220006	1.785,27	2.100,47	2.939,02
1000	300	1	BBN0115610120006	1.232,39	1.449,96	2.029,58
1000	300	2	BBN0115610220006	1.993,42	2.345,72	3.283,78
1000	400	1	BBN0115810120006	1.522,05	1.790,98	2.507,04
1000	400	2	BBN0115810220006	2.428,58	2.857,64	3.999,43

LINGO SHELVING SYSTEM

BBN011 - LOW WOODEN BACK PANEL - CASTOR PLATE - FOR TOP SHELF



LINGO SHELVING SYSTEM

BBN011 - LOW WOODEN BACK PANEL - CASTOR PLATE - FOR TOP SHELF

Shelving system with wooden panels, low wooden back panel and castor plate.
To be used with ST1 full depth, WT1 full depth and WT1 double-sided top shelf.

- Prices based on steel price group 1 and wooden price group A (see Design Options pages 6-9).
- For top shelves, see pages 156 & 174
- For shelves see page 144 & 166.
- For accessories see page 186.

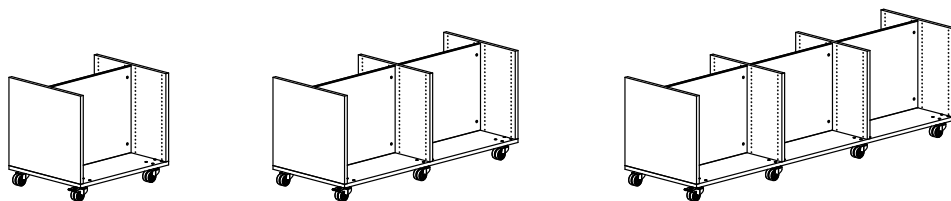

Double-sided H720 mm - 1/2/3 bays

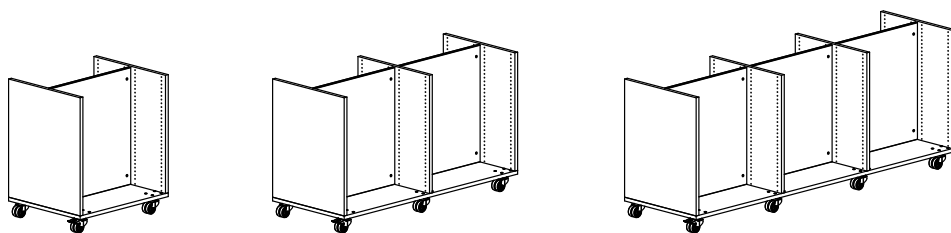

Double-sided H920 mm - 1/2/3 bays

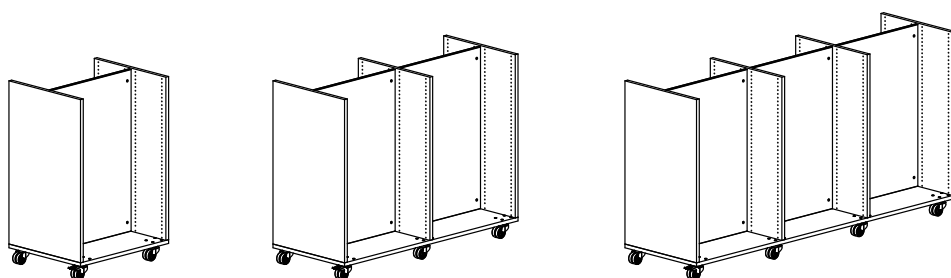

Double-sided H1220 mm - 1/2/3 bays

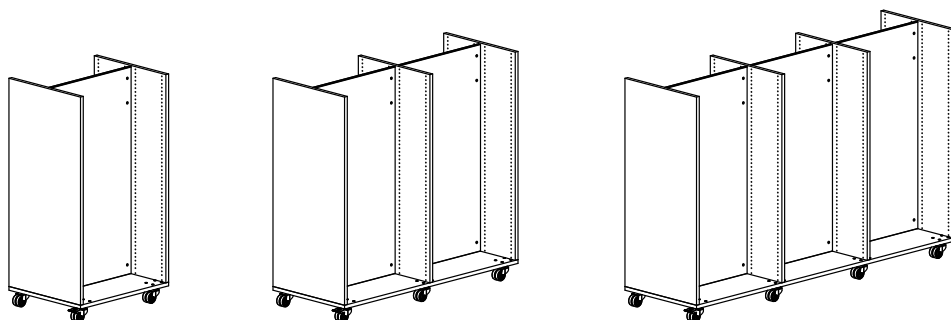

Double-sided H1520 mm - 1/2/3 bays

LINGO SHELVING SYSTEM

DOUBLE-SIDED - LOW WOODEN BACK PANEL - CASTOR PLATE - FOR TOP SHELF

Painted and veneered Lingo Shelving Systems are FSC-certified.

H720 mm

Module mm	Shelf depth mm	No. of bays	Item no.	Melamine EUR	Painted EUR	Veneer EUR
500	250	1	BBN011245011000.	485,45	570,70	799,32
500	250	2	BBN011245021000.	762,63	896,69	1.256,04
500	250	3	BBN011245031000.	1.083,56	1.273,88	1.783,91
500	300	1	BBN011265011000.	580,01	682,02	955,87
500	300	2	BBN011265021000.	904,93	1.064,13	1.490,79
500	300	3	BBN011265031000.	1.278,13	1.502,76	2.105,25
500	400	1	BBN011285011000.	743,48	874,47	1.224,39
500	400	2	BBN011285021000.	1.149,81	1.352,34	1.893,91
500	400	3	BBN011285031000.	1.609,47	1.892,71	2.650,94
750	250	1	BBN011247011000.	606,75	713,81	999,89
750	250	2	BBN011247021000.	962,26	1.131,96	1.585,22
750	250	3	BBN011247031000.	1.382,81	1.626,85	2.278,29
750	300	1	BBN011267011000.	711,28	836,83	1.172,26
750	300	2	BBN011267021000.	1.119,06	1.316,42	1.844,18
750	300	3	BBN011267031000.	1.599,20	1.881,27	2.635,67
750	400	1	BBN011287011000.	884,20	1.040,32	1.456,88
750	400	2	BBN011287021000.	1.378,44	1.621,65	2.271,37
750	400	3	BBN011287031000.	1.951,94	2.296,89	3.216,87
900	250	1	BBN011249011000.	685,08	805,85	1.128,10
900	250	2	BBN011249021000.	1.092,59	1.284,91	1.799,21
900	300	1	BBN011269011000.	795,33	935,39	1.309,91
900	300	2	BBN011269021000.	1.258,03	1.479,62	2.072,26
900	400	1	BBN011289011000.	973,83	1.145,52	1.604,50
900	400	2	BBN011289021000.	1.526,05	1.795,09	2.513,55
1000	250	1	BBN011241011000.	728,44	856,92	1.199,38
1000	250	2	BBN011241021000.	1.162,02	1.367,10	1.913,58
1000	300	1	BBN011261011000.	842,69	991,24	1.387,58
1000	300	2	BBN011261021000.	1.333,06	1.568,46	2.196,09
1000	400	1	BBN011281011000.	1.024,91	1.205,90	1.688,42
1000	400	2	BBN011281021000.	1.607,06	1.890,84	2.646,81

LINGO SHELVING SYSTEM

DOUBLE-SIDED - LOW WOODEN BACK PANEL - CASTOR PLATE - FOR TOP SHELF

Painted and veneered Lingo Shelving Systems are FSC-certified.

H920 mm

Module mm	Shelf depth mm	No. of bays	Item no.	Melamine EUR	Painted EUR	Veneer EUR
500	250	1	BBN011345011000.	571,77	672,58	942,03
500	250	2	BBN011345021000.	901,75	1.060,95	1.486,13
500	250	3	BBN011345031000.	1.275,48	1.500,52	2.101,38
500	300	1	BBN011365011000.	687,61	809,18	1.133,70
500	300	2	BBN011365021000.	1.075,97	1.266,31	1.773,56
500	300	3	BBN011365031000.	1.512,61	1.779,96	2.492,96
500	400	1	BBN011385011000.	890,96	1.047,91	1.467,12
500	400	2	BBN011385021000.	1.380,67	1.623,94	2.274,03
500	400	3	BBN011385031000.	1.923,71	2.262,47	3.168,45
750	250	1	BBN011347011000.	702,91	826,86	1.158,03
750	250	2	BBN011347021000.	1.121,06	1.318,56	1.846,17
750	250	3	BBN011347031000.	1.604,25	1.887,00	2.642,05
750	300	1	BBN011367011000.	828,72	975,16	1.365,52
750	300	2	BBN011367021000.	1.309,78	1.540,94	2.157,81
750	300	3	BBN011367031000.	1.863,20	2.191,98	3.069,67
750	400	1	BBN011387011000.	1.041,52	1.224,93	1.715,04
750	400	2	BBN011387021000.	1.628,98	1.915,59	2.682,35
750	400	3	BBN011387031000.	2.295,70	2.700,16	3.780,67
900	250	1	BBN011349011000.	788,43	927,68	1.298,61
900	250	2	BBN011349021000.	1.265,77	1.489,07	2.084,90
900	300	1	BBN011369011000.	919,96	1.082,50	1.515,54
900	300	2	BBN011369021000.	1.463,13	1.721,70	2.410,63
900	400	1	BBN011389011000.	1.138,34	1.338,91	1.875,03
900	400	2	BBN011389021000.	1.790,97	2.106,59	2.949,27
1000	250	1	BBN011341011000.	834,18	981,28	1.373,35
1000	250	2	BBN011341021000.	1.339,98	1.576,32	2.206,19
1000	300	1	BBN011361011000.	969,71	1.140,88	1.596,67
1000	300	2	BBN011361021000.	1.542,94	1.815,60	2.541,38
1000	400	1	BBN011381011000.	1.191,81	1.401,82	1.962,41
1000	400	2	BBN011381021000.	1.876,76	2.207,40	3.089,45

LINGO SHELVING SYSTEM

DOUBLE-SIDED - LOW WOODEN BACK PANEL - CASTOR PLATE - FOR TOP SHELF

Painted and veneered Lingo Shelving Systems are FSC-certified.

H1220 mm

Module mm	Shelf depth mm	No. of bays	Item no.	Melamine EUR	Painted EUR	Veneer EUR
500	250	1	BBN011445011000.	700,11	823,79	1.153,90
500	250	2	BBN011445021000.	1.109,09	1.305,25	1.828,34
500	250	3	BBN011445031000.	1.561,82	1.837,91	2.573,93
500	300	1	BBN011465011000.	838,83	986,99	1.382,79
500	300	2	BBN011465021000.	1.317,63	1.550,51	2.171,60
500	300	3	BBN011465031000.	1.844,71	2.170,55	3.039,95
500	400	1	BBN011485011000.	1.097,52	1.291,42	1.808,27
500	400	2	BBN011485021000.	1.705,34	2.006,69	2.810,16
500	400	3	BBN011485031000.	2.366,49	2.784,46	3.899,56
750	250	1	BBN011447011000.	846,41	995,77	1.394,50
750	250	2	BBN011447021000.	1.358,72	1.598,26	2.237,58
750	250	3	BBN011447031000.	1.936,07	2.277,49	3.188,40
750	300	1	BBN011467011000.	995,10	1.170,67	1.639,21
750	300	2	BBN011467021000.	1.581,76	1.860,54	2.605,05
750	300	3	BBN011467031000.	2.240,78	2.635,67	3.690,46
750	400	1	BBN011487011000.	1.263,24	1.486,14	2.080,79
750	400	2	BBN011487021000.	1.983,97	2.333,74	3.267,68
750	400	3	BBN011487031000.	2.783,96	3.275,25	4.585,58
900	250	1	BBN011449011000.	935,26	1.100,57	1.541,21
900	250	2	BBN011449021000.	1.510,09	1.776,73	2.488,57
900	300	1	BBN011469011000.	1.089,67	1.281,99	1.795,36
900	300	2	BBN011469021000.	1.741,77	2.049,26	2.870,13
900	400	1	BBN011489011000.	1.363,39	1.604,10	2.246,91
900	400	2	BBN011489021000.	2.152,62	2.532,70	3.546,86
1000	250	1	BBN011441011000.	992,18	1.167,34	1.634,30
1000	250	2	BBN011441021000.	1.606,64	1.890,32	2.646,56
1000	300	1	BBN011461011000.	1.150,59	1.353,54	1.894,84
1000	300	2	BBN011461021000.	1.843,92	2.169,50	3.037,58
1000	400	1	BBN011481011000.	1.428,03	1.680,18	2.352,64
1000	400	2	BBN011481021000.	2.260,75	2.659,85	3.723,74

LINGO SHELVING SYSTEM

DOUBLE-SIDED - LOW WOODEN BACK PANEL - CASTOR PLATE - FOR TOP SHELF

Painted and veneered Lingo Shelving Systems are FSC-certified.

H1520 mm

Module mm	Shelf depth mm	No. of bays	Item no.	Melamine EUR	Painted EUR	Veneer EUR
500	250	1	BBN011545011000.	774,33	910,78	1.274,93
500	250	2	BBN011545021000.	1.233,72	1.451,30	2.031,70
500	250	3	BBN011545031000.	1.736,86	2.043,02	2.859,62
500	300	1	BBN011565011000.	893,63	1.051,36	1.472,98
500	300	2	BBN011565021000.	1.413,13	1.662,63	2.328,70
500	300	3	BBN011565031000.	1.980,91	2.330,42	3.263,96
500	400	1	BBN011585011000.	1.164,54	1.370,17	1.918,12
500	400	2	BBN011585021000.	1.819,17	2.140,38	2.996,75
500	400	3	BBN011585031000.	2.527,13	2.973,09	4.162,89
750	250	1	BBN011547011000.	933,54	1.098,31	1.537,34
750	250	2	BBN011547021000.	1.509,17	1.775,41	2.484,56
750	250	3	BBN011547031000.	2.149,84	2.529,25	3.539,52
750	300	1	BBN011567011000.	1.062,81	1.250,59	1.751,21
750	300	2	BBN011567021000.	1.703,08	2.003,76	2.805,77
750	300	3	BBN011567031000.	2.415,71	2.842,19	3.979,90
750	400	1	BBN011587011000.	1.343,17	1.580,44	2.212,45
750	400	2	BBN011587021000.	2.123,62	2.498,53	3.497,89
750	400	3	BBN011587031000.	2.983,33	3.510,53	4.914,34
900	250	1	BBN011549011000.	1.034,22	1.216,82	1.703,20
900	250	2	BBN011549021000.	1.684,20	1.981,30	2.773,85
900	300	1	BBN011569011000.	1.169,21	1.375,62	1.926,51
900	300	2	BBN011569021000.	1.886,75	2.219,90	3.109,15
900	400	1	BBN011589011000.	1.455,15	1.712,11	2.397,72
900	400	2	BBN011589021000.	2.315,93	2.724,91	3.815,37
1000	250	1	BBN011541011000.	1.093,40	1.286,38	1.799,88
1000	250	2	BBN011541021000.	1.785,27	2.100,47	2.939,02
1000	300	1	BBN011561011000.	1.232,39	1.449,96	2.029,58
1000	300	2	BBN011561021000.	1.993,42	2.345,72	3.283,78
1000	400	1	BBN011581011000.	1.522,05	1.790,98	2.507,04
1000	400	2	BBN011581021000.	2.428,58	2.857,64	3.999,43

LINGO SHELVING SYSTEM

BBN011 - CROSS BRACE - CASTOR PLATE - FOR TOP SHELF



LINGO SHELVING SYSTEM

BBN011 - CROSS BRACE - CASTOR PLATE - FOR TOP SHELF

Shelving system with wooden panels, cross brace and castor plate.

To be used with top shelf.

Middle shelf must be screwed into panels for H1520 mm.

- Prices based on steel price group 1 and wooden price group A (see Design Options pages 6-9).

- For top shelves, see pages 156 & 174

- For shelves see page 144 & 166.

- For accessories see page 186.

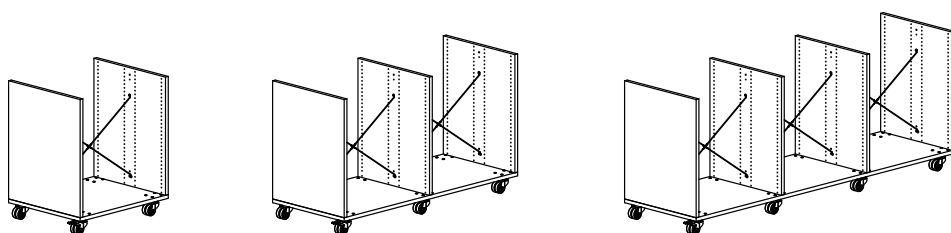

Double-sided H920 mm - 1/2/3 bays

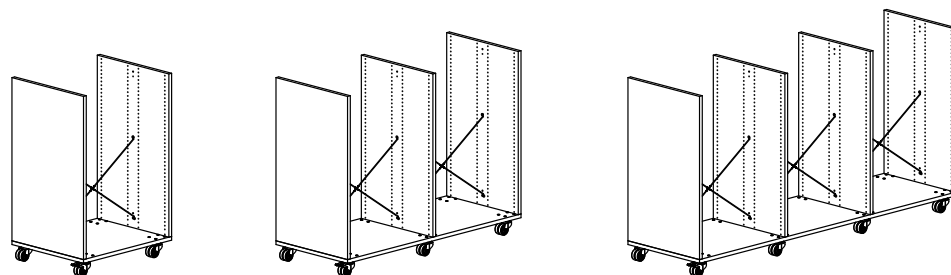

Double-sided H1220 mm - 1/2/3 bays

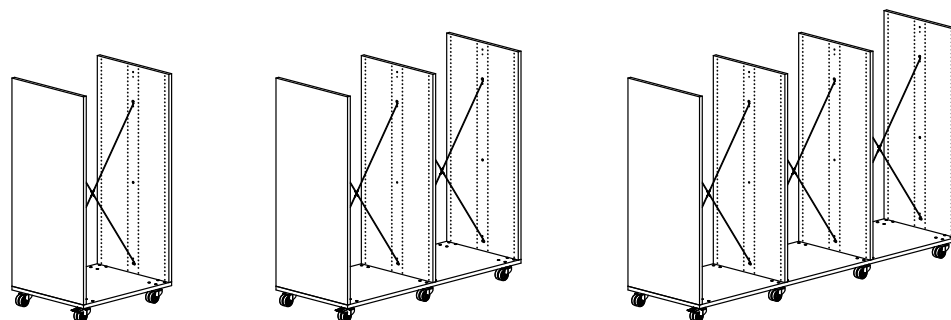

Double-sided H1520 mm - 1/2/3 bays

LINGO SHELVING SYSTEM

DOUBLE-SIDED - CROSS BRACE - CASTOR PLATE - FOR TOP SHELF

Painted and veneered Lingo Shelving Systems are FSC-certified.

H920 mm

Module mm	Shelf depth mm	No. of bays	Item no.	Melamine EUR	Painted EUR	Veneer EUR
500	250	1	BBN011345019000.	505,27	590,38	817,81
500	250	2	BBN011345029000.	768,75	896,55	1.237,69
500	250	3	BBN011345039000.	1.075,98	1.253,92	1.728,72
500	300	1	BBN011365019000.	621,11	726,98	1.009,48
500	300	2	BBN011365029000.	942,97	1.101,91	1.525,12
500	300	3	BBN011365039000.	1.313,11	1.533,36	2.120,30
500	400	1	BBN011385019000.	824,46	965,71	1.342,90
500	400	2	BBN011385029000.	1.247,67	1.459,54	2.025,59
500	400	3	BBN011385039000.	1.724,21	2.015,87	2.795,79
750	250	1	BBN011347019000.	591,99	692,53	960,92
750	250	2	BBN011347029000.	899,22	1.049,90	1.451,95
750	250	3	BBN011347039000.	1.271,49	1.484,01	2.050,72
750	300	1	BBN011367019000.	717,80	840,83	1.168,41
750	300	2	BBN011367029000.	1.087,94	1.272,28	1.763,59
750	300	3	BBN011367039000.	1.530,44	1.788,99	2.478,34
750	400	1	BBN011387019000.	930,60	1.090,60	1.517,93
750	400	2	BBN011387029000.	1.407,14	1.646,93	2.288,13
750	400	3	BBN011387039000.	1.962,94	2.297,17	3.189,34
900	250	1	BBN011349019000.	644,26	754,11	1.046,71
900	250	2	BBN011349029000.	977,43	1.141,93	1.581,10
900	300	1	BBN011369019000.	775,79	908,93	1.263,64
900	300	2	BBN011369029000.	1.174,79	1.374,56	1.906,83
900	400	1	BBN011389019000.	994,17	1.165,34	1.623,13
900	400	2	BBN011389029000.	1.502,63	1.759,45	2.445,47
1000	250	1	BBN011341019000.	678,97	794,81	1.103,76
1000	250	2	BBN011341029000.	1.029,56	1.203,38	1.667,01
1000	300	1	BBN011361019000.	814,50	954,41	1.327,08
1000	300	2	BBN011361029000.	1.232,52	1.442,66	2.002,20
1000	400	1	BBN011381019000.	1.036,60	1.215,35	1.692,82
1000	400	2	BBN011381029000.	1.566,34	1.834,46	2.550,27

LINGO SHELVING SYSTEM

DOUBLE-SIDED - CROSS BRACE - CASTOR PLATE - FOR TOP SHELF

Painted and veneered Lingo Shelving Systems are FSC-certified.

H1220 mm

Module mm	Shelf depth mm	No. of bays	Item no.	Melamine EUR	Painted EUR	Veneer EUR
500	250	1	BBN011445019000.	603,95	706,62	980,87
500	250	2	BBN011445029000.	916,77	1.070,91	1.482,28
500	250	3	BBN011445039000.	1.273,34	1.486,40	2.054,84
500	300	1	BBN011465019000.	742,67	869,82	1.209,76
500	300	2	BBN011465029000.	1.125,31	1.316,17	1.825,54
500	300	3	BBN011465039000.	1.556,23	1.819,04	2.520,86
500	400	1	BBN011485019000.	1.001,36	1.174,25	1.635,24
500	400	2	BBN011485029000.	1.513,02	1.772,35	2.464,10
500	400	3	BBN011485039000.	2.078,01	2.432,95	3.380,47
750	250	1	BBN011447019000.	690,67	808,77	1.123,98
750	250	2	BBN011447029000.	1.047,24	1.224,26	1.696,54
750	250	3	BBN011447039000.	1.468,85	1.716,49	2.376,84
750	300	1	BBN011467019000.	839,36	983,67	1.368,69
750	300	2	BBN011467029000.	1.270,28	1.486,54	2.064,01
750	300	3	BBN011467039000.	1.773,56	2.074,67	2.878,90
750	400	1	BBN011487019000.	1.107,50	1.299,14	1.810,27
750	400	2	BBN011487029000.	1.672,49	1.959,74	2.726,64
750	400	3	BBN011487039000.	2.316,74	2.714,25	3.774,02
900	250	1	BBN011449019000.	742,94	870,35	1.209,77
900	250	2	BBN011449029000.	1.125,45	1.316,29	1.825,69
900	300	1	BBN011469019000.	897,35	1.051,77	1.463,92
900	300	2	BBN011469029000.	1.357,13	1.588,82	2.207,25
900	400	1	BBN011489019000.	1.171,07	1.373,88	1.915,47
900	400	2	BBN011489029000.	1.767,98	2.072,26	2.883,98
1000	250	1	BBN011441019000.	777,65	911,05	1.266,82
1000	250	2	BBN011441029000.	1.177,58	1.377,74	1.911,60
1000	300	1	BBN011461019000.	936,06	1.097,25	1.527,36
1000	300	2	BBN011461029000.	1.414,86	1.656,92	2.302,62
1000	400	1	BBN011481019000.	1.213,50	1.423,89	1.985,16
1000	400	2	BBN011481029000.	1.831,69	2.147,27	2.988,78

LINGO SHELVING SYSTEM

DOUBLE-SIDED - CROSS BRACE - CASTOR PLATE - FOR TOP SHELF

Painted and veneered Lingo Shelving Systems are FSC-certified.

H1520 mm

Module mm	Shelf depth mm	No. of bays	Item no.	Melamine EUR	Painted EUR	Veneer EUR
500	250	1	BBN011545019000.	651,57	762,48	1.058,27
500	250	2	BBN011545029000.	988,20	1.154,70	1.598,38
500	250	3	BBN011545039000.	1.368,58	1.598,12	2.209,64
500	300	1	BBN011565019000.	770,87	903,06	1.256,32
500	300	2	BBN011565029000.	1.167,61	1.366,03	1.895,38
500	300	3	BBN011565039000.	1.612,63	1.885,52	2.613,98
500	400	1	BBN011585019000.	1.041,78	1.221,87	1.701,46
500	400	2	BBN011585029000.	1.573,65	1.843,78	2.563,43
500	400	3	BBN011585039000.	2.158,85	2.528,19	3.512,91
750	250	1	BBN011547019000.	738,29	864,63	1.201,38
750	250	2	BBN011547029000.	1.118,67	1.308,05	1.812,64
750	250	3	BBN011547039000.	1.564,09	1.828,21	2.531,64
750	300	1	BBN011567019000.	867,56	1.016,91	1.415,25
750	300	2	BBN011567029000.	1.312,58	1.536,40	2.133,85
750	300	3	BBN011567039000.	1.829,96	2.141,15	2.972,02
750	400	1	BBN011587019000.	1.147,92	1.346,76	1.876,49
750	400	2	BBN011587029000.	1.733,12	2.031,17	2.825,97
750	400	3	BBN011587039000.	2.397,58	2.809,49	3.906,46
900	250	1	BBN011549019000.	790,56	926,21	1.287,17
900	250	2	BBN011549029000.	1.196,88	1.400,08	1.941,79
900	300	1	BBN011569019000.	925,55	1.085,01	1.510,48
900	300	2	BBN011569029000.	1.399,43	1.638,68	2.277,09
900	400	1	BBN011589019000.	1.211,49	1.421,50	1.981,69
900	400	2	BBN011589029000.	1.828,61	2.143,69	2.983,31
1000	250	1	BBN011541019000.	825,27	966,91	1.344,22
1000	250	2	BBN011541029000.	1.249,01	1.461,53	2.027,70
1000	300	1	BBN011561019000.	964,26	1.130,49	1.573,92
1000	300	2	BBN011561029000.	1.457,16	1.706,78	2.372,46
1000	400	1	BBN011581019000.	1.253,92	1.471,51	2.051,38
1000	400	2	BBN011581029000.	1.892,32	2.218,70	3.088,11

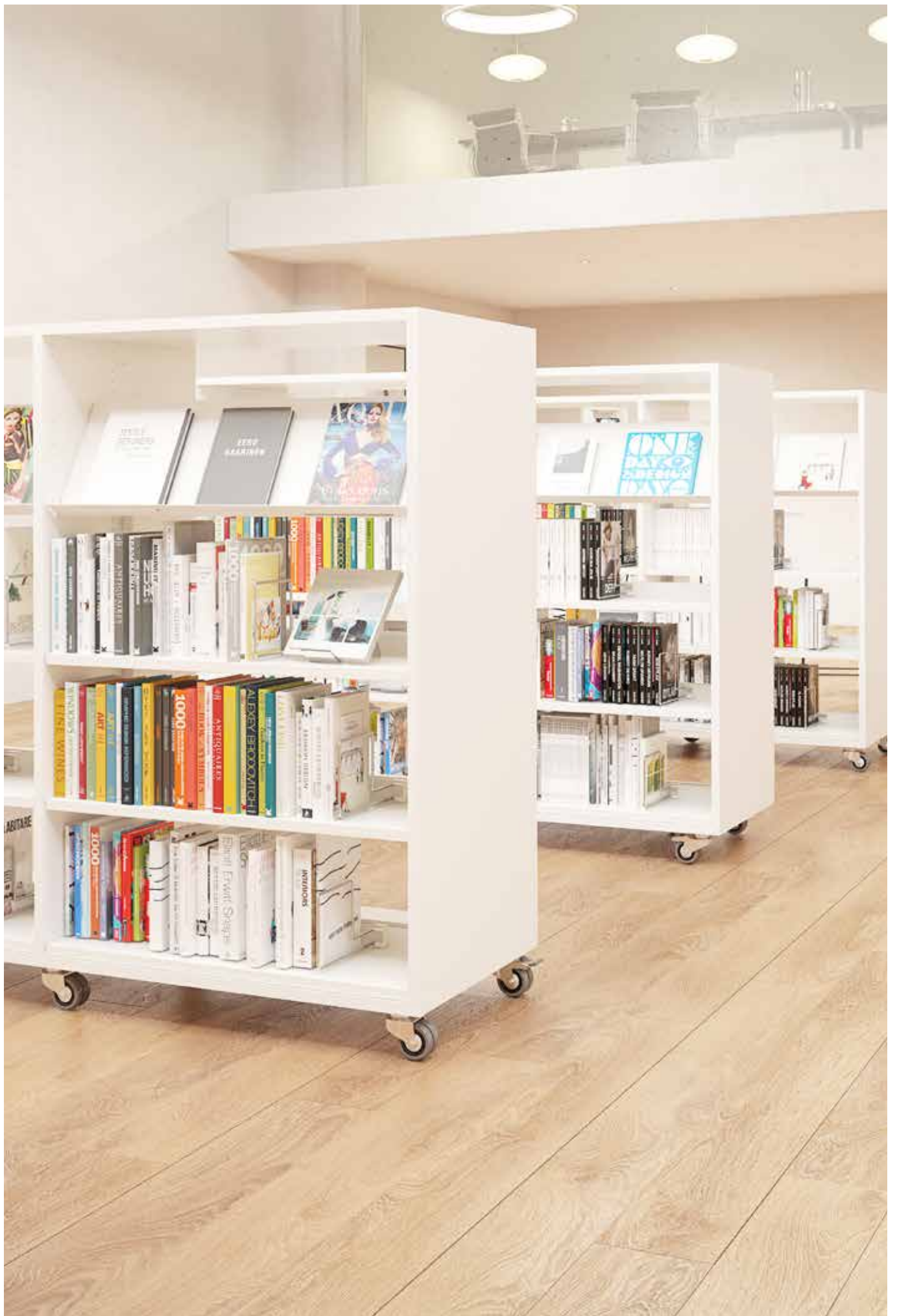

LINGO SHELVING SYSTEM

BBN012 - STEEL BACK FRAME - CASTOR PLATE - WITH OVERLAYING WOODEN TOP PLATE



LINGO SHELVING SYSTEM

BBN012 - STEEL BACK FRAME - CASTOR PLATE - WITH OVERLAYING WOODEN TOP PLATE

Shelving system with wooden panels, metal back frame, castor plate and overlaying top plate.

- Prices based on steel price group 1 and wooden price group A (see Design Options pages 6-9).
- For shelves see page 144 & 166.
- For accessories see page 186.

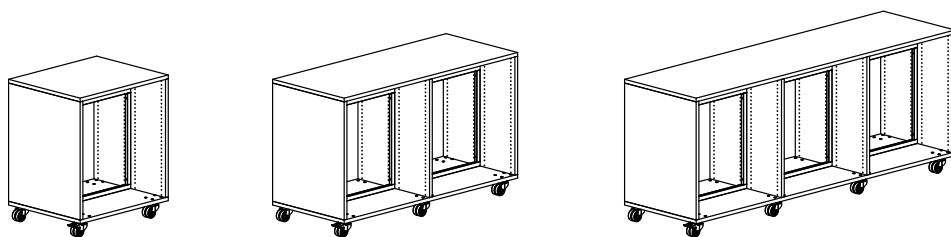

Double-sided H920 mm - 1/2/3 bays

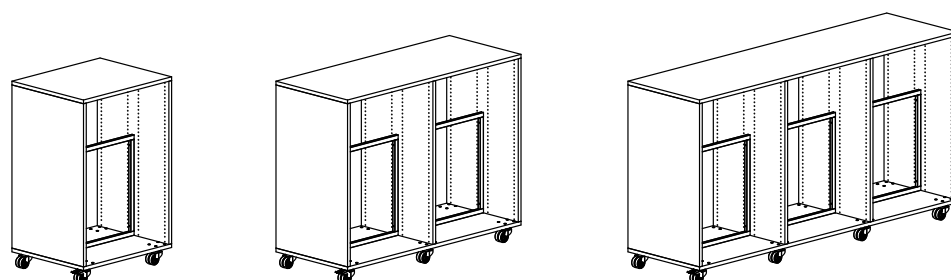

Double-sided H1220 mm - 1/2/3 bays

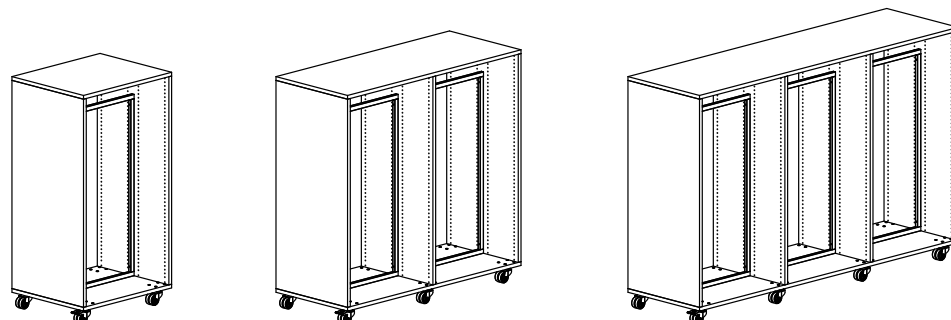

Double-sided H1520 mm - 1/2/3 bays

LINGO SHELVING SYSTEM

DOUBLE-SIDED - STEEL BACK FRAME - CASTOR PLATE - WITH OVERLAYING WOODEN TOP PLATE

Painted and veneered Lingo Shelving Systems are FSC-certified.

H920 mm

Module mm	Shelf depth mm	No. of bays	Item no.	Melamine EUR	Painted EUR	Veneer EUR
500	250	1	BBN012345016100.	669,66	773,52	1.050,82
500	250	2	BBN012345026100.	1.075,84	1.237,43	1.668,61
500	250	3	BBN012345036100.	1.536,82	1.765,43	2.375,76
500	300	1	BBN012365016100.	797,07	923,95	1.262,05
500	300	2	BBN012365026100.	1.271,21	1.467,79	1.991,15
500	300	3	BBN012365036100.	1.805,74	2.082,38	2.819,74
500	400	1	BBN012385016100.	1.012,39	1.176,51	1.615,02
500	400	2	BBN012385026100.	1.597,19	1.850,56	2.526,60
500	400	3	BBN012385036100.	2.248,76	2.602,53	3.547,77
750	250	1	BBN012347016100.	809,58	938,58	1.281,85
750	250	2	BBN012347026100.	1.302,34	1.503,69	2.041,00
750	250	3	BBN012347036100.	1.875,97	2.164,57	2.934,37
750	300	1	BBN012367016100.	953,34	1.107,49	1.518,60
750	300	2	BBN012367026100.	1.522,71	1.763,45	2.405,05
750	300	3	BBN012367036100.	2.183,07	2.526,07	3.441,12
750	400	1	BBN012387016100.	1.183,70	1.378,14	1.897,38
750	400	2	BBN012387026100.	1.873,83	2.175,73	2.982,25
750	400	3	BBN012387036100.	2.663,45	3.090,78	4.230,72
900	250	1	BBN012349016100.	861,85	1.000,16	1.367,64
900	250	2	BBN012349026100.	1.380,55	1.595,72	2.170,15
900	300	1	BBN012369016100.	1.011,33	1.175,59	1.613,83
900	300	2	BBN012369026100.	1.609,56	1.865,73	2.548,29
900	400	1	BBN012389016100.	1.247,27	1.452,88	2.002,58
900	400	2	BBN012389026100.	1.969,32	2.288,25	3.139,59
1000	250	1	BBN012341016100.	925,15	1.072,11	1.464,59
1000	250	2	BBN012341026100.	1.485,61	1.715,83	2.329,75
1000	300	1	BBN012361016100.	1.080,23	1.254,99	1.720,23
1000	300	2	BBN012361026100.	1.724,08	1.996,87	2.723,32
1000	400	1	BBN012381016100.	1.321,88	1.538,94	2.118,42
1000	400	2	BBN012381026100.	2.093,28	2.430,30	3.330,05

LINGO SHELVING SYSTEM

DOUBLE-SIDED - STEEL BACK FRAME - CASTOR PLATE - WITH OVERLAYING WOODEN TOP PLATE

Painted and veneered Lingo Shelving Systems are FSC-certified.

H1220 mm

Module mm	Shelf depth mm	No. of bays	Item no.	Melamine EUR	Painted EUR	Veneer EUR
500	250	1	BBN012445016100.	768,34	889,76	1.213,88
500	250	2	BBN012445026100.	1.223,86	1.411,79	1.913,20
500	250	3	BBN012445036100.	1.734,18	1.997,91	2.701,88
500	300	1	BBN012465016100.	918,63	1.066,79	1.462,33
500	300	2	BBN012465026100.	1.453,55	1.682,05	2.291,57
500	300	3	BBN012465036100.	2.048,86	2.368,06	3.220,30
500	400	1	BBN012485016100.	1.189,29	1.385,05	1.907,36
500	400	2	BBN012485026100.	1.862,54	2.163,37	2.965,11
500	400	3	BBN012485036100.	2.602,56	3.019,61	4.132,45
750	250	1	BBN012447016100.	908,26	1.054,82	1.444,91
750	250	2	BBN012447026100.	1.450,36	1.678,05	2.285,59
750	250	3	BBN012447036100.	2.073,33	2.397,05	3.260,49
750	300	1	BBN012467016100.	1.074,90	1.250,33	1.718,88
750	300	2	BBN012467026100.	1.705,05	1.977,71	2.705,47
750	300	3	BBN012467036100.	2.426,19	2.811,75	3.841,68
750	400	1	BBN012487016100.	1.360,60	1.586,68	2.189,72
750	400	2	BBN012487026100.	2.139,18	2.488,54	3.420,76
750	400	3	BBN012487036100.	3.017,25	3.507,86	4.815,40
900	250	1	BBN012449016100.	960,53	1.116,40	1.530,70
900	250	2	BBN012449026100.	1.528,57	1.770,08	2.414,74
900	300	1	BBN012469016100.	1.132,89	1.318,43	1.814,11
900	300	2	BBN012469026100.	1.791,90	2.079,99	2.848,71
900	400	1	BBN012489016100.	1.424,17	1.661,42	2.294,92
900	400	2	BBN012489026100.	2.234,67	2.601,06	3.578,10
1000	250	1	BBN012441016100.	1.023,83	1.188,35	1.627,65
1000	250	2	BBN012441026100.	1.633,63	1.890,19	2.574,34
1000	300	1	BBN012461016100.	1.201,79	1.397,83	1.920,51
1000	300	2	BBN012461026100.	1.906,42	2.211,13	3.023,74
1000	400	1	BBN012481016100.	1.498,78	1.747,48	2.410,76
1000	400	2	BBN012481026100.	2.358,63	2.743,11	3.768,56

LINGO SHELVING SYSTEM

DOUBLE-SIDED - STEEL BACK FRAME - CASTOR PLATE - WITH OVERLAYING WOODEN TOP PLATE

Painted and veneered Lingo Shelving Systems are FSC-certified.

H1520 mm

Module mm	Shelf depth mm	No. of bays	Item no.	Melamine EUR	Painted EUR	Veneer EUR
500	250	1	BBN012545016100.	839,90	969,56	1.315,22
500	250	2	BBN012545026100.	1.343,17	1.543,46	2.077,18
500	250	3	BBN012545036100.	1.901,24	2.181,45	2.928,50
500	300	1	BBN012565016100.	970,77	1.123,97	1.532,83
500	300	2	BBN012565026100.	1.543,73	1.779,79	2.409,29
500	300	3	BBN012565036100.	2.177,08	2.506,36	3.385,24
500	400	1	BBN012585016100.	1.253,65	1.456,61	1.997,52
500	400	2	BBN012585026100.	1.971,05	2.282,68	3.112,32
500	400	3	BBN012585036100.	2.755,22	3.186,67	4.336,71
750	250	1	BBN012547016100.	979,82	1.134,62	1.546,25
750	250	2	BBN012547026100.	1.569,67	1.809,72	2.449,57
750	250	3	BBN012547036100.	2.240,39	2.580,59	3.487,11
750	300	1	BBN012567016100.	1.127,04	1.307,51	1.789,38
750	300	2	BBN012567026100.	1.795,23	2.075,45	2.823,19
750	300	3	BBN012567036100.	2.554,41	2.950,05	4.006,62
750	400	1	BBN012587016100.	1.424,96	1.658,24	2.279,88
750	400	2	BBN012587026100.	2.247,69	2.607,85	3.567,97
750	400	3	BBN012587036100.	3.169,91	3.674,92	5.019,66
900	250	1	BBN012549016100.	1.032,09	1.196,20	1.632,04
900	250	2	BBN012549026100.	1.647,88	1.901,75	2.578,72
900	300	1	BBN012569016100.	1.185,03	1.375,61	1.884,61
900	300	2	BBN012569026100.	1.882,08	2.177,73	2.966,43
900	400	1	BBN012589016100.	1.488,53	1.732,98	2.385,08
900	400	2	BBN012589026100.	2.343,18	2.720,37	3.725,31
1000	250	1	BBN012541016100.	1.098,32	1.271,08	1.731,92
1000	250	2	BBN012541026100.	1.758,80	2.027,72	2.744,18
1000	300	1	BBN012561016100.	1.256,86	1.457,94	1.993,94
1000	300	2	BBN012561026100.	2.002,46	2.314,73	3.147,32
1000	400	1	BBN012581016100.	1.566,07	1.821,97	2.503,85
1000	400	2	BBN012581026100.	2.473,00	2.868,28	3.921,63



LINGO SHELVING SYSTEM

BBN012 - WOODEN BACK PANEL - CASTOR PLATE - WITH OVERLAYING WOODEN TOP PLATE



LINGO SHELVING SYSTEM

BBN012 - WOODEN BACK PANEL - CASTOR PLATE - WITH OVERLAYING WOODEN TOP PLATE

Shelving system with wooden panels, wooden back panel, castor plate and overlaying top plate.

- Prices based on steel price group 1 and wooden price group A (see Design Options pages 6-9).
- For shelves see page 144 & 166.
- For accessories see page 186.

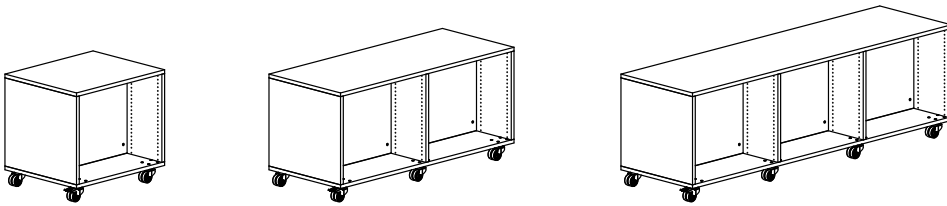

Double-sided H720 mm - 1/2/3 bays

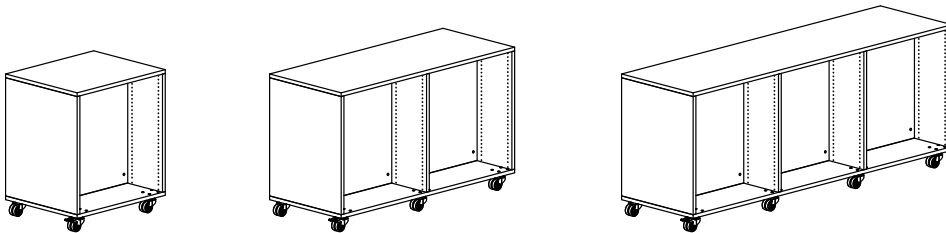

Double-sided H920 mm - 1/2/3 bays

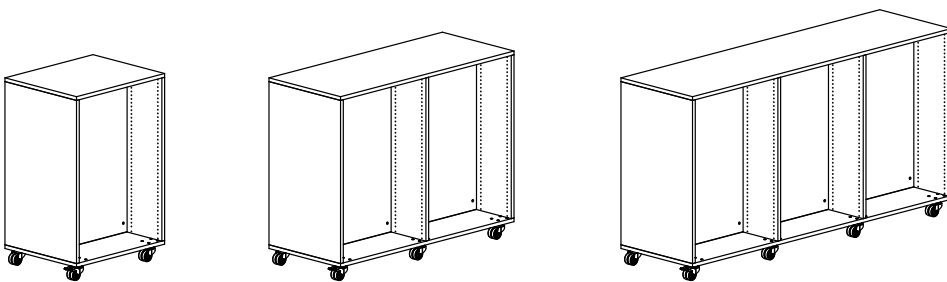

Double-sided H1220 mm - 1/2/3 bays

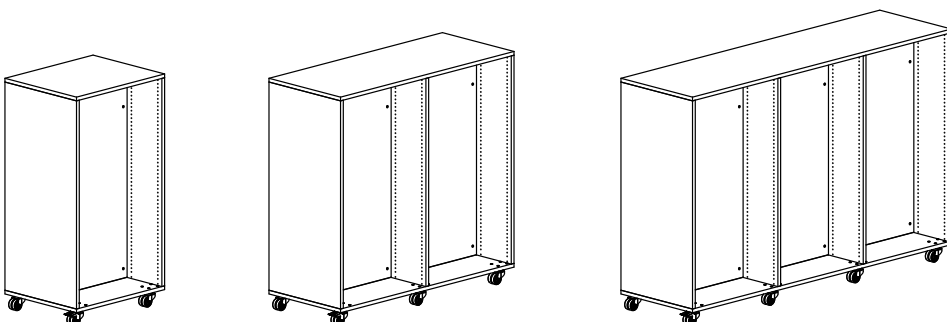

Double-sided H1520 mm - 1/2/3 bays

LINGO SHELVING SYSTEM

DOUBLE-SIDED - WOODEN BACK PANEL - CASTOR PLATE - WITH OVERLAYING WOODEN TOP PLATE

Painted and veneered Lingo Shelving Systems are FSC-certified.

H720 mm

Module mm	Shelf depth mm	No. of bays	Item no.	Melamine EUR	Painted EUR	Veneer EUR
500	250	1	BBN012245012100.	592,12	696,12	974,61
500	250	2	BBN012245022100.	954,28	1.122,13	1.571,52
500	250	3	BBN012245032100.	1.371,24	1.612,23	2.257,79
500	300	1	BBN012265012100.	698,25	821,27	1.150,72
500	300	2	BBN012265022100.	1.117,73	1.314,57	1.841,38
500	300	3	BBN012265032100.	1.597,60	1.878,62	2.631,53
500	400	1	BBN012285012100.	873,69	1.027,55	1.438,79
500	400	2	BBN012285022100.	1.383,89	1.627,92	2.279,48
500	400	3	BBN012285032100.	1.960,86	2.306,21	3.229,76
750	250	1	BBN012247012100.	766,62	902,14	1.263,10
750	250	2	BBN012247022100.	1.249,94	1.470,31	2.058,83
750	250	3	BBN012247032100.	1.814,13	2.134,25	2.988,78
750	300	1	BBN012267012100.	889,10	1.045,77	1.464,73
750	300	2	BBN012267022100.	1.438,39	1.692,15	2.370,20
750	300	3	BBN012267032100.	2.078,67	2.445,19	3.425,29
750	400	1	BBN012287012100.	1.079,58	1.270,14	1.778,61
750	400	2	BBN012287022100.	1.729,69	2.035,01	2.850,05
750	400	3	BBN012287032100.	2.479,29	2.917,34	4.085,09
900	250	1	BBN012249012100.	844,95	994,18	1.391,31
900	250	2	BBN012249022100.	1.380,27	1.623,26	2.272,82
900	300	1	BBN012269012100.	973,15	1.144,33	1.602,38
900	300	2	BBN012269022100.	1.577,36	1.855,35	2.598,28
900	400	1	BBN012289012100.	1.169,21	1.375,34	1.926,23
900	400	2	BBN012289022100.	1.877,30	2.208,45	3.092,23
1000	250	1	BBN012241012100.	906,26	1.065,86	1.491,85
1000	250	2	BBN012241022100.	1.481,35	1.742,83	2.439,60
1000	300	1	BBN012261012100.	1.040,06	1.223,46	1.712,37
1000	300	2	BBN012261022100.	1.687,90	1.985,95	2.780,49
1000	400	1	BBN012281012100.	1.241,83	1.461,13	2.045,66
1000	400	2	BBN012281022100.	1.997,28	2.349,96	3.289,87

LINGO SHELVING SYSTEM

DOUBLE-SIDED - WOODEN BACK PANEL - CASTOR PLATE - WITH OVERLAYING WOODEN TOP PLATE

Painted and veneered Lingo Shelving Systems are FSC-certified.

H920 mm

Module mm	Shelf depth mm	No. of bays	Item no.	Melamine EUR	Painted EUR	Veneer EUR
500	250	1	BBN012345012100.	678,44	798,00	1.117,32
500	250	2	BBN012345022100.	1.093,40	1.286,39	1.801,61
500	250	3	BBN012345032100.	1.563,16	1.838,87	2.575,26
500	300	1	BBN012365012100.	805,85	948,43	1.328,55
500	300	2	BBN012365022100.	1.288,77	1.516,75	2.124,15
500	300	3	BBN012365032100.	1.832,08	2.155,82	3.019,24
500	400	1	BBN012385012100.	1.021,17	1.200,99	1.681,52
500	400	2	BBN012385022100.	1.614,75	1.899,52	2.659,60
500	400	3	BBN012385032100.	2.275,10	2.675,97	3.747,27
750	250	1	BBN012347012100.	862,78	1.015,19	1.421,24
750	250	2	BBN012347022100.	1.408,74	1.656,91	2.319,78
750	250	3	BBN012347032100.	2.035,57	2.394,40	3.352,54
750	300	1	BBN012367012100.	1.006,54	1.184,10	1.657,99
750	300	2	BBN012367022100.	1.629,11	1.916,67	2.683,83
750	300	3	BBN012367032100.	2.342,67	2.755,90	3.859,29
750	400	1	BBN012387012100.	1.236,90	1.454,75	2.036,77
750	400	2	BBN012387022100.	1.980,23	2.328,95	3.261,03
750	400	3	BBN012387032100.	2.823,05	3.320,61	4.648,89
900	250	1	BBN012349012100.	948,30	1.116,01	1.561,82
900	250	2	BBN012349022100.	1.553,45	1.827,42	2.558,51
900	300	1	BBN012369012100.	1.097,78	1.291,44	1.808,01
900	300	2	BBN012369022100.	1.782,46	2.097,43	2.936,65
900	400	1	BBN012389012100.	1.333,72	1.568,73	2.196,76
900	400	2	BBN012389022100.	2.142,22	2.519,95	3.527,95
1000	250	1	BBN012341012100.	1.012,00	1.190,22	1.665,82
1000	250	2	BBN012341022100.	1.659,31	1.952,05	2.732,21
1000	300	1	BBN012361012100.	1.167,08	1.373,10	1.921,46
1000	300	2	BBN012361022100.	1.897,78	2.233,09	3.125,78
1000	400	1	BBN012381012100.	1.408,73	1.657,05	2.319,65
1000	400	2	BBN012381022100.	2.266,98	2.666,52	3.732,51

LINGO SHELVING SYSTEM

DOUBLE-SIDED - WOODEN BACK PANEL - CASTOR PLATE - WITH OVERLAYING WOODEN TOP PLATE

Painted and veneered Lingo Shelving Systems are FSC-certified.

H1220 mm

Module mm	Shelf depth mm	No. of bays	Item no.	Melamine EUR	Painted EUR	Veneer EUR
500	250	1	BBN012445012100.	806,78	949,21	1.329,19
500	250	2	BBN012445022100.	1.300,74	1.530,69	2.143,82
500	250	3	BBN012445032100.	1.849,50	2.176,26	3.047,81
500	300	1	BBN012465012100.	957,07	1.126,24	1.577,64
500	300	2	BBN012465022100.	1.530,43	1.800,95	2.522,19
500	300	3	BBN012465032100.	2.164,18	2.546,41	3.566,23
500	400	1	BBN012485012100.	1.227,73	1.444,50	2.022,67
500	400	2	BBN012485022100.	1.939,42	2.282,27	3.195,73
500	400	3	BBN012485032100.	2.717,88	3.197,96	4.478,38
750	250	1	BBN012447012100.	1.006,28	1.184,10	1.657,71
750	250	2	BBN012447022100.	1.646,40	1.936,61	2.711,19
750	250	3	BBN012447032100.	2.367,39	2.784,89	3.898,89
750	300	1	BBN012467012100.	1.172,92	1.379,61	1.931,68
750	300	2	BBN012467022100.	1.901,09	2.236,27	3.131,07
750	300	3	BBN012467032100.	2.720,25	3.199,59	4.480,08
750	400	1	BBN012487012100.	1.458,62	1.715,96	2.402,52
750	400	2	BBN012487022100.	2.335,22	2.747,10	3.846,36
750	400	3	BBN012487032100.	3.311,31	3.895,70	5.453,80
900	250	1	BBN012449012100.	1.095,13	1.288,90	1.804,42
900	250	2	BBN012449022100.	1.797,77	2.115,08	2.962,18
900	300	1	BBN012469012100.	1.267,49	1.490,93	2.087,83
900	300	2	BBN012469022100.	2.061,10	2.424,99	3.396,15
900	400	1	BBN012489012100.	1.558,77	1.833,92	2.568,64
900	400	2	BBN012489022100.	2.503,87	2.946,06	4.125,54
1000	250	1	BBN012441012100.	1.170,00	1.376,28	1.926,77
1000	250	2	BBN012441022100.	1.925,97	2.266,05	3.172,58
1000	300	1	BBN012461012100.	1.347,96	1.585,76	2.219,63
1000	300	2	BBN012461022100.	2.198,76	2.586,99	3.621,98
1000	400	1	BBN012481012100.	1.644,95	1.935,41	2.709,88
1000	400	2	BBN012481022100.	2.650,97	3.118,97	4.366,80

LINGO SHELVING SYSTEM

DOUBLE-SIDED - WOODEN BACK PANEL - CASTOR PLATE - WITH OVERLAYING WOODEN TOP PLATE

Painted and veneered Lingo Shelving Systems are FSC-certified.

H1520 mm

Module mm	Shelf depth mm	No. of bays	Item no.	Melamine EUR	Painted EUR	Veneer EUR
500	250	1	BBN012545012100.	881,00	1.036,20	1.450,22
500	250	2	BBN012545022100.	1.425,37	1.676,74	2.347,18
500	250	3	BBN012545032100.	2.024,54	2.381,37	3.333,50
500	300	1	BBN012565012100.	1.011,87	1.190,61	1.667,83
500	300	2	BBN012565022100.	1.625,93	1.913,07	2.679,29
500	300	3	BBN012565032100.	2.300,38	2.706,28	3.790,24
500	400	1	BBN012585012100.	1.294,75	1.523,25	2.132,52
500	400	2	BBN012585022100.	2.053,25	2.415,96	3.382,32
500	400	3	BBN012585032100.	2.878,52	3.386,59	4.741,71
750	250	1	BBN012547012100.	1.093,41	1.286,64	1.800,55
750	250	2	BBN012547022100.	1.796,85	2.113,76	2.958,17
750	250	3	BBN012547032100.	2.581,16	3.036,65	4.250,01
750	300	1	BBN012567012100.	1.240,63	1.459,53	2.043,68
750	300	2	BBN012567022100.	2.022,41	2.379,49	3.331,79
750	300	3	BBN012567032100.	2.895,18	3.406,11	4.769,52
750	400	1	BBN012587012100.	1.538,55	1.810,26	2.534,18
750	400	2	BBN012587022100.	2.474,87	2.911,89	4.076,57
750	400	3	BBN012587032100.	3.510,68	4.130,98	5.782,56
900	250	1	BBN012549012100.	1.194,09	1.405,15	1.966,41
900	250	2	BBN012549022100.	1.971,88	2.319,65	3.247,46
900	300	1	BBN012569012100.	1.347,03	1.584,56	2.218,98
900	300	2	BBN012569022100.	2.206,08	2.595,63	3.635,17
900	400	1	BBN012589012100.	1.650,53	1.941,93	2.719,45
900	400	2	BBN012589022100.	2.667,18	3.138,27	4.394,05
1000	250	1	BBN012541012100.	1.271,22	1.495,32	2.092,35
1000	250	2	BBN012541022100.	2.104,60	2.476,20	3.465,04
1000	300	1	BBN012561012100.	1.429,76	1.682,18	2.354,37
1000	300	2	BBN012561022100.	2.348,26	2.763,21	3.868,18
1000	400	1	BBN012581012100.	1.738,97	2.046,21	2.864,28
1000	400	2	BBN012581022100.	2.818,80	3.316,76	4.642,49

LINGO SHELVING SYSTEM

BBN012 - CROSS BRACE - CASTOR PLATE - WITH OVERLAYING WOODEN TOP PLATE



LINGO SHELVING SYSTEM

BBN012 - CROSS BRACE - CASTOR PLATE - WITH OVERLAYING WOODEN TOP PLATE

Shelving system with wooden panels, cross brace, castor plate and overlaying top plate.
Middle shelf must be screwed into panels for H1520 mm.

- Prices based on steel price group 1 and wooden price group A (see Design Options pages 6-9).
- For shelves see page 144 & 166.
- For accessories see page 186.

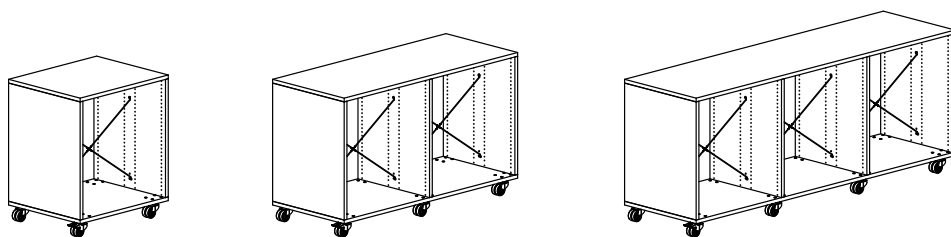

Double-sided H920 mm - 1/2/3 bays

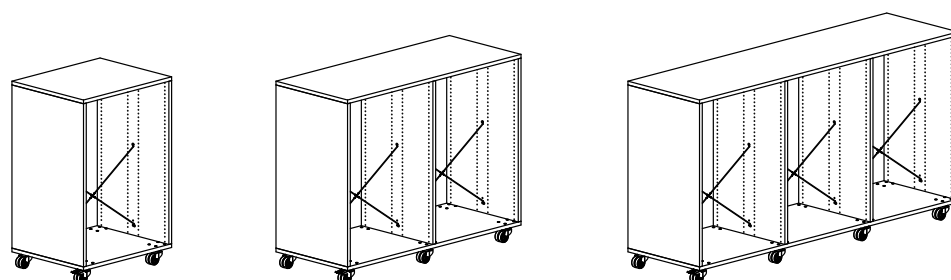

Double-sided H1220 mm - 1/2/3 bays

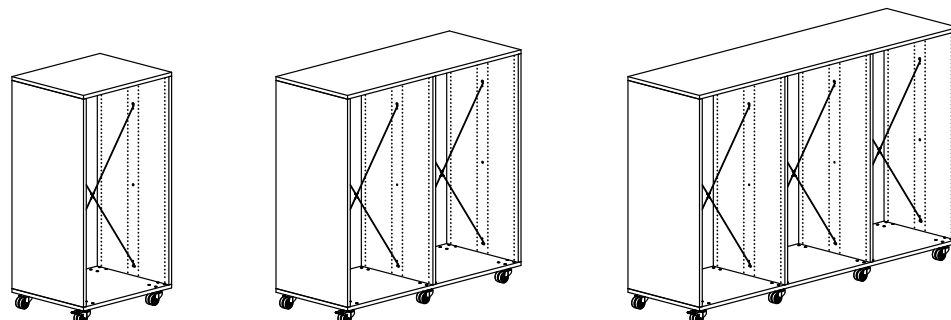

Double-sided H1520 mm - 1/2/3 bays

LINGO SHELVING SYSTEM

DOUBLE-SIDED - CROSS BRACE - CASTOR PLATE - WITH OVERLAYING WOODEN TOP PLATE

Painted and veneered Lingo Shelving Systems are FSC-certified.

H920 mm

Module mm	Shelf depth mm	No. of bays	Item no.	Melamine EUR	Painted EUR	Veneer EUR
500	250	1	BBN0123450191006	611,94	715,80	993,10
500	250	2	BBN0123450291006	960,40	1.121,99	1.553,17
500	250	3	BBN0123450391006	1.363,66	1.592,27	2.202,60
500	300	1	BBN0123650191006	739,35	866,23	1.204,33
500	300	2	BBN0123650291006	1.155,77	1.352,35	1.875,71
500	300	3	BBN0123650391006	1.632,58	1.909,22	2.646,58
500	400	1	BBN0123850191006	954,67	1.118,79	1.557,30
500	400	2	BBN0123850291006	1.481,75	1.735,12	2.411,16
500	400	3	BBN0123850391006	2.075,60	2.429,37	3.374,61
750	250	1	BBN0123470191006	751,86	880,86	1.224,13
750	250	2	BBN0123470291006	1.186,90	1.388,25	1.925,56
750	250	3	BBN0123470391006	1.702,81	1.991,41	2.761,21
750	300	1	BBN0123670191006	895,62	1.049,77	1.460,88
750	300	2	BBN0123670291006	1.407,27	1.648,01	2.289,61
750	300	3	BBN0123670391006	2.009,91	2.352,91	3.267,96
750	400	1	BBN0123870191006	1.125,98	1.320,42	1.839,66
750	400	2	BBN0123870291006	1.758,39	2.060,29	2.866,81
750	400	3	BBN0123870391006	2.490,29	2.917,62	4.057,56
900	250	1	BBN0123490191006	804,13	942,44	1.309,92
900	250	2	BBN0123490291006	1.265,11	1.480,28	2.054,71
900	300	1	BBN0123690191006	953,61	1.117,87	1.556,11
900	300	2	BBN0123690291006	1.494,12	1.750,29	2.432,85
900	400	1	BBN0123890191006	1.189,55	1.395,16	1.944,86
900	400	2	BBN0123890291006	1.853,88	2.172,81	3.024,15
1000	250	1	BBN0123410191006	856,79	1.003,75	1.396,23
1000	250	2	BBN0123410291006	1.348,89	1.579,11	2.193,03
1000	300	1	BBN0123610191006	1.011,87	1.186,63	1.651,87
1000	300	2	BBN0123610291006	1.587,36	1.860,15	2.586,60
1000	400	1	BBN0123810191006	1.253,52	1.470,58	2.050,06
1000	400	2	BBN0123810291006	1.956,56	2.293,58	3.193,33

LINGO SHELVING SYSTEM

DOUBLE-SIDED - CROSS BRACE - CASTOR PLATE - WITH OVERLAYING WOODEN TOP PLATE

Painted and veneered Lingo Shelving Systems are FSC-certified.

H1220 mm

Module mm	Shelf depth mm	No. of bays	Item no.	Melamine EUR	Painted EUR	Veneer EUR
500	250	1	BBN0124450191006	710,62	832,04	1.156,16
500	250	2	BBN0124450291006	1.108,42	1.296,35	1.797,76
500	250	3	BBN0124450391006	1.561,02	1.824,75	2.528,72
500	300	1	BBN0124650191006	860,91	1.009,07	1.404,61
500	300	2	BBN0124650291006	1.338,11	1.566,61	2.176,13
500	300	3	BBN0124650391006	1.875,70	2.194,90	3.047,14
500	400	1	BBN0124850191006	1.131,57	1.327,33	1.849,64
500	400	2	BBN0124850291006	1.747,10	2.047,93	2.849,67
500	400	3	BBN0124850391006	2.429,40	2.846,45	3.959,29
750	250	1	BBN0124470191006	850,54	997,10	1.387,19
750	250	2	BBN0124470291006	1.334,92	1.562,61	2.170,15
750	250	3	BBN0124470391006	1.900,17	2.223,89	3.087,33
750	300	1	BBN0124670191006	1.017,18	1.192,61	1.661,16
750	300	2	BBN0124670291006	1.589,61	1.862,27	2.590,03
750	300	3	BBN0124670391006	2.253,03	2.638,59	3.668,52
750	400	1	BBN0124870191006	1.302,88	1.528,96	2.132,00
750	400	2	BBN0124870291006	2.023,74	2.373,10	3.305,32
750	400	3	BBN0124870391006	2.844,09	3.334,70	4.642,24
900	250	1	BBN0124490191006	902,81	1.058,68	1.472,98
900	250	2	BBN0124490291006	1.413,13	1.654,64	2.299,30
900	300	1	BBN0124690191006	1.075,17	1.260,71	1.756,39
900	300	2	BBN0124690291006	1.676,46	1.964,55	2.733,27
900	400	1	BBN0124890191006	1.366,45	1.603,70	2.237,20
900	400	2	BBN0124890291006	2.119,23	2.485,62	3.462,66
1000	250	1	BBN0124410191006	955,47	1.119,99	1.559,29
1000	250	2	BBN0124410291006	1.496,91	1.753,47	2.437,62
1000	300	1	BBN0124610191006	1.133,43	1.329,47	1.852,15
1000	300	2	BBN0124610291006	1.769,70	2.074,41	2.887,02
1000	400	1	BBN0124810191006	1.430,42	1.679,12	2.342,40
1000	400	2	BBN0124810291006	2.221,91	2.606,39	3.631,84

LINGO SHELVING SYSTEM

DOUBLE-SIDED - CROSS BRACE - CASTOR PLATE - WITH OVERLAYING WOODEN TOP PLATE

Painted and veneered Lingo Shelving Systems are FSC-certified.

H1520 mm

Module mm	Shelf depth mm	No. of bays	Item no.	Melamine EUR	Painted EUR	Veneer EUR
500	250	1	BBN0125450191006	758,24	887,90	1.233,56
500	250	2	BBN0125450291006	1.179,85	1.380,14	1.913,86
500	250	3	BBN0125450391006	1.656,26	1.936,47	2.683,52
500	300	1	BBN0125650191006	889,11	1.042,31	1.451,17
500	300	2	BBN0125650291006	1.380,41	1.616,47	2.245,97
500	300	3	BBN0125650391006	1.932,10	2.261,38	3.140,26
500	400	1	BBN0125850191006	1.171,99	1.374,95	1.915,86
500	400	2	BBN0125850291006	1.807,73	2.119,36	2.949,00
500	400	3	BBN0125850391006	2.510,24	2.941,69	4.091,73
750	250	1	BBN0125470191006	898,16	1.052,96	1.464,59
750	250	2	BBN0125470291006	1.406,35	1.646,40	2.286,25
750	250	3	BBN0125470391006	1.995,41	2.335,61	3.242,13
750	300	1	BBN0125670191006	1.045,38	1.225,85	1.707,72
750	300	2	BBN0125670291006	1.631,91	1.912,13	2.659,87
750	300	3	BBN0125670391006	2.309,43	2.705,07	3.761,64
750	400	1	BBN0125870191006	1.343,30	1.576,58	2.198,22
750	400	2	BBN0125870291006	2.084,37	2.444,53	3.404,65
750	400	3	BBN0125870391006	2.924,93	3.429,94	4.774,68
900	250	1	BBN0125490191006	950,43	1.114,54	1.550,38
900	250	2	BBN0125490291006	1.484,56	1.738,43	2.415,40
900	300	1	BBN0125690191006	1.103,37	1.293,95	1.802,95
900	300	2	BBN0125690291006	1.718,76	2.014,41	2.803,11
900	400	1	BBN0125890191006	1.406,87	1.651,32	2.303,42
900	400	2	BBN0125890291006	2.179,86	2.557,05	3.561,99
1000	250	1	BBN0125410191006	1.003,09	1.175,85	1.636,69
1000	250	2	BBN0125410291006	1.568,34	1.837,26	2.553,72
1000	300	1	BBN0125610191006	1.161,63	1.362,71	1.898,71
1000	300	2	BBN0125610291006	1.812,00	2.124,27	2.956,86
1000	400	1	BBN0125810191006	1.470,84	1.726,74	2.408,62
1000	400	2	BBN0125810291006	2.282,54	2.677,82	3.731,17



LINGO SQUARE



LINGO SQUARE

WITH PLINTH

Lingo Square can be used in different environments for display, storage and exhibition. The top plate (also available in laminate) can also serve as a worktable, display or a play area. Each configuration consists of end panels, back panels, top and bottom plate, plinth and fittings. Painted and veneered Lingo Squares are FSC-certified. For shelves see from page 144, for accessories see from page 186.

H920 (939 mm) - for 2 shelves

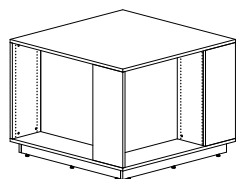

Module mm	Shelf depth mm	Total width mm	Item no.	Melamine EUR	Painted EUR	Veneer EUR
500	250	811	BBN130352200.	1.247,55	1.467,25	2.053,63
500	300	861	BBN130353200.	1.342,51	1.579,08	2.210,33
750	250	1061	BBN130372200.	1.675,26	1.970,55	2.758,16
750	300	1111	BBN130373200.	1.789,11	2.104,59	2.946,11
900	250	1211	BBN130392200.	1.960,69	2.305,96	3.228,68
900	300	1261	BBN130393200.	2.077,47	2.444,00	3.421,96

H1220 (1239 mm) - for 3 shelves

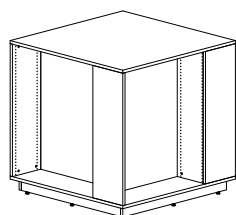

Module mm	Shelf depth mm	Total width mm	Item no.	Melamine EUR	Painted EUR	Veneer EUR
500	250	811	BBN130452200.	1.468,31	1.727,41	2.419,15
500	300	861	BBN130453200.	1.529,23	1.799,36	2.519,97
750	250	1061	BBN130472200.	1.944,46	2.287,63	3.202,40
750	300	1111	BBN130473200.	2.024,27	2.381,79	3.334,47
900	250	1211	BBN130492200.	2.242,13	2.636,88	3.691,56
900	300	1261	BBN130493200.	2.324,87	2.735,04	3.828,96

H1520 (1539 mm) - for 4 shelves

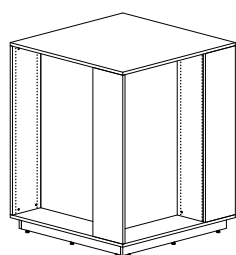

Module mm	Shelf depth mm	Total width mm	Item no.	Melamine EUR	Painted EUR	Veneer EUR
500	250	811	BBN130552200.	1.625,27	1.912,01	2.677,19
500	300	861	BBN130553200.	1.685,11	1.982,40	2.775,33
750	250	1061	BBN130572200.	2.142,90	2.520,59	3.529,56
750	300	1111	BBN130573200.	2.221,63	2.613,19	3.658,95
900	250	1211	BBN130592200.	2.477,29	2.914,56	4.081,00
900	300	1261	BBN130593200.	2.558,95	3.011,16	4.215,72

H1820 (1839 mm) - for 5 shelves

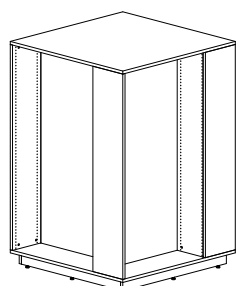

Module mm	Shelf depth mm	Total width mm	Item no.	Melamine EUR	Painted EUR	Veneer EUR
500	250	811	BBN130652200.	1.802,95	2.120,01	2.968,15
500	300	861	BBN130653200.	1.857,47	2.184,52	3.058,33
750	250	1061	BBN130672200.	2.356,22	2.771,75	3.880,12
750	300	1111	BBN130673200.	2.429,63	2.858,47	4.001,55
900	250	1211	BBN130692200.	2.731,01	3.212,48	4.498,04
900	300	1261	BBN130693200.	2.807,35	3.303,20	4.624,80

LINGO SQUARE



LINGO SQUARE

WITH CASTORS

Lingo Square can be used in different environments for display, storage and exhibition. The top plate (available in laminate) can also serve as a worktable, display or a play area. Each configuration consists of end panels, back panels, top and bottom plate, 8 castors (Ø75 mm, 2 with brakes) and fittings. Painted and veneered Lingo Squares are FSC-certified. For shelves see from page 144, for accessories see from page 186.

H920 (939 mm) - for 2 shelves

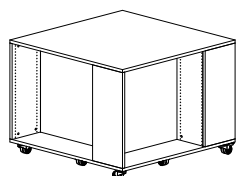

Module mm	Shelf depth mm	Total width mm	Item no.	Melamine EUR	Painted EUR	Veneer EUR
500	250	811	BBN130352100.	1.154,31	1.357,79	1.900,15
500	300	861	BBN130353100.	1.243,96	1.463,11	2.047,94
750	250	1061	BBN130372100.	1.535,48	1.806,03	2.527,80
750	300	1111	BBN130373100.	1.641,48	1.930,89	2.703,12
900	250	1211	BBN130392100.	1.796,83	2.113,25	2.958,83
900	300	1261	BBN130393100.	1.905,50	2.241,57	3.138,40

H1220 (1239 mm) - for 3 shelves

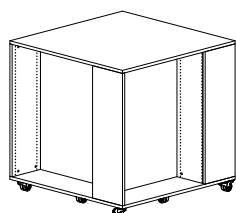

Module mm	Shelf depth mm	Total width mm	Item no.	Melamine EUR	Painted EUR	Veneer EUR
500	250	811	BBN130452100.	1.375,07	1.617,95	2.265,67
500	300	861	BBN130453100.	1.430,68	1.683,39	2.357,58
750	250	1061	BBN130472100.	1.804,68	2.123,11	2.972,04
750	300	1111	BBN130473100.	1.876,64	2.208,09	3.091,48
900	250	1211	BBN130492100.	2.078,27	2.444,17	3.421,71
900	300	1261	BBN130493100.	2.152,90	2.532,61	3.545,40

H1520 (1539 mm) - for 4 shelves

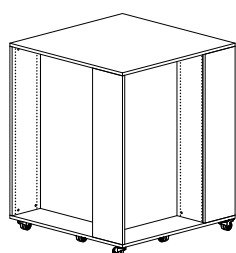

Module mm	Shelf depth mm	Total width mm	Item no.	Melamine EUR	Painted EUR	Veneer EUR
500	250	811	BBN130552100.	1.532,03	1.802,55	2.523,71
500	300	861	BBN130553100.	1.586,56	1.866,43	2.612,94
750	250	1061	BBN130572100.	2.003,12	2.356,07	3.299,20
750	300	1111	BBN130573100.	2.074,00	2.439,49	3.415,96
900	250	1211	BBN130592100.	2.313,43	2.721,85	3.811,15
900	300	1261	BBN130593100.	2.386,98	2.808,73	3.932,16

H1820 (1839 mm) - for 5 shelves

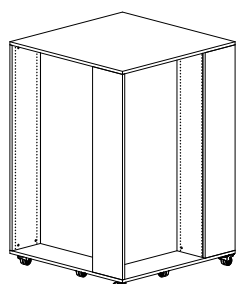

Module mm	Shelf depth mm	Total width mm	Item no.	Melamine EUR	Painted EUR	Veneer EUR
500	250	811	BBN130652100.	1.709,71	2.010,55	2.814,67
500	300	861	BBN130653100.	1.758,92	2.068,55	2.895,94
750	250	1061	BBN130672100.	2.216,44	2.607,23	3.649,76
750	300	1111	BBN130673100.	2.282,00	2.684,77	3.758,56
900	250	1211	BBN130692100.	2.567,15	3.019,77	4.228,19
900	300	1261	BBN130693100.	2.635,38	3.100,77	4.341,24



COMPONENTS

CHECK LIST

When constructing your shelving, there are many factors to be taken into consideration and most importantly, you must remember to order all parts. Below you will find a check list of components you need to consider when constructing your wooden shelving.

SHELVES

The following factors are all to be considered before choosing the shelf:

- steel or wooden shelf
- hanging or backedge book support
- max. weight
- type of fixture
- steel/wooden topshelf or wooden overlaying top plate

ACCESSORIES

- Supply or exchange a shelf with a function; e.g. a browser or multimedia storage.

CASTORS

Extra components to complete the function and design of shelving:

- castor frame with castors
- castor plate with castors
- plinth

PANELS

The following factors are all to be considered before choosing the panel:

- design (standard/slat - slat is only available for double-sided shelving H1520-2120 MM)
- volume (single-sided/double-sided)
- height (720/920/1220/1520/1820/2120 mm)
- depth (250/300/400 mm)
- stationary or mobile (adjustable feet/castor frame/castor plate)
- top (top shelf/overlaying top plate)

CONNECTION ELEMENTS

To support the shelving and determine the design of shelving system, you must choose between one of the 3 connection elements:

- steel back frame
- wooden back panel
- galvanized cross brace

SHELVES

S1 & S2 - STEEL SHELVES

See below for overview of standard steel shelves:

S1 - STEEL SHELF WITH STEEL BACKEDGE - FOR BACKEDGE BOOK SUPPORT

Details:

- Module 500/750/900/1000 mm
- Depth 250/300/400 mm
- Steel backedge H47 mm
- Backedge book support
- Steel brackets
- Max. weight 80 kg.
- Straight, 45°/60° sloping & 7,5° reverse tilted

Use with:

- ST1 - steel top shelf
- WT1 - wooden top shelf
- WO1 - wooden overlaying top plate

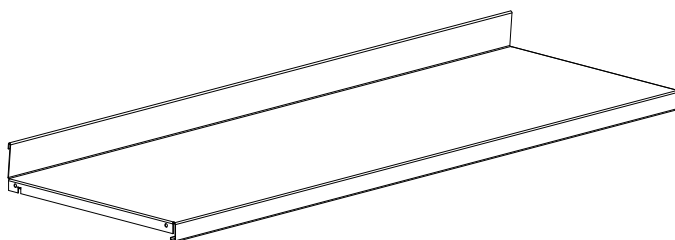

Note:

- Steel shelves placed at the bottom, must always be fixed with screws.
- Shelving H1820 and 2120 with cross brace must always have one intermediate steel shelf fixed with screws.

S2 - STEEL SHELF WITH ACRYLIC BACKEDGE - FOR HANGING BOOK SUPPORT

Details:

- Module 500/750/900/1000 mm
- Depth 250/300/400 mm
- Acrylic backedge H17 mm (loose part)
- Hanging book support
- Steel brackets
- Max. weight 80 kg.
- Straight, 45°/60° sloping & 7,5° reverse tilted

Use with:

- ST2 - steel top shelf
- WT1 - wooden top shelf
- WO1 - wooden overlaying top plate

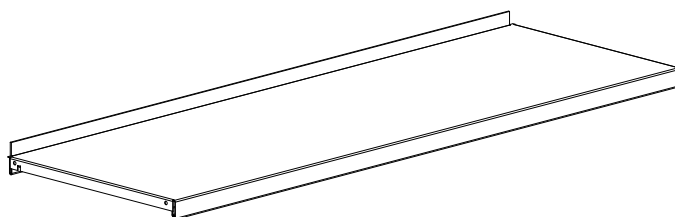

Note:

- Steel shelves placed at the bottom, must always be fixed with screws.
- Shelving H1820 and 2120 with cross brace must always have one intermediate steel shelf fixed with screws.

SHELVES

S3 & S4 - STEEL SHELVES

See below for overview of standard steel shelves:

S3 - STEEL SHELF WITH STEEL BACKEDGE - FOR HANGING BOOK SUPPORT

Details:

- Module 500/750/900/1000 mm
- Depth 250/300/400 mm
- Steel backedge H25 mm
- Hanging book support
- Pins/screws
- Max. weight 80 kg.
- Straight and sloping

Use with:

- ST3 - steel top shelf
- WT1 - wooden top shelf
- WO1 - wooden overlaying top plate

Note:

- Steel shelves placed at the bottom, must always be fixed with screws.
- Shelving H1820 and 2120 with cross brace must always have one intermediate steel shelf fixed with screws.

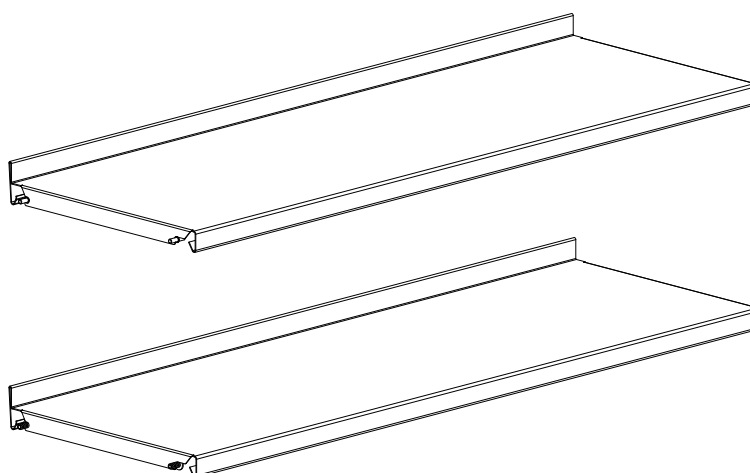

S4 - STEEL SHELF WITH NO BACKEDGE - FOR HANGING BOOK SUPPORT

Details:

- Module 500/750/900/1000 mm
- Depth 250/300/400 mm
- No backedge
- Hanging book support
- Pins/screws
(use screws for cross brace H1820 og 2120 mm)
- Max. weight 80 kg.
- Straight

Use with:

- ST3 - steel top shelf
- WT1 - wooden top shelf
- WO1 - wooden overlaying top plate
-

Note:

- Steel shelves placed at the bottom, must always be fixed with screws.
- Shelving H1820 and 2120 with cross brace must always have one intermediate steel shelf fixed with screws.

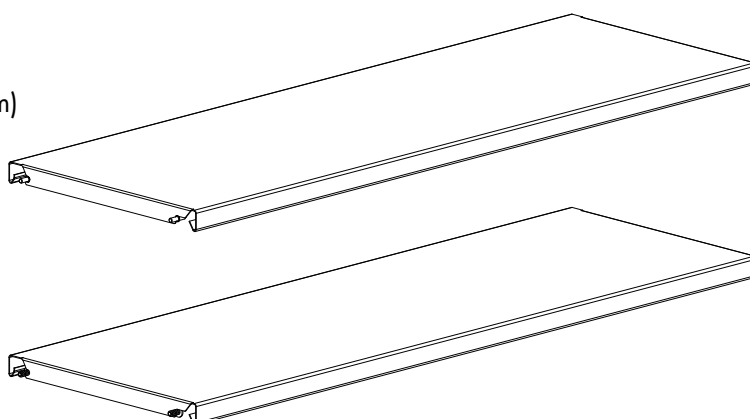

SHELVES

S1 - STEEL SHELF & COMPONENTS

S1 - Steel shelf with steel backedge and steel brackets - for backedge book support

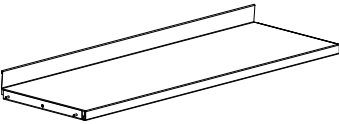
Steel backedge 47 mm.	Module mm	Shelf depth mm	Item no.	Price EUR
	500	250	BBN0901152	71,16
	500	300	BBN0901153	74,49
	500	400	BBN0901154	85,79
	750	250	BBN0901172	71,16
	750	300	BBN0901173	74,49
	750	400	BBN0901174	85,79
	900	250	BBN0901192	74,35
	900	300	BBN0901193	79,27
	900	400	BBN0901194	97,63
	1000	250	BBN0901112	81,40
	1000	300	BBN0901113	85,39
	1000	400	BBN0901114	100,55

S1 - Steel shelf with steel frontedge and 45°/60° steel plate brackets

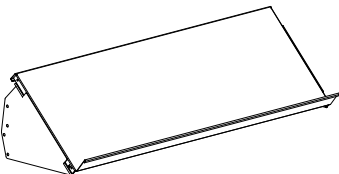
Steel frontedge 47 mm.	Module mm	Shelf depth mm	Item no.	Price EUR
	500	250	BBN0901352	117,98
	500	300	BBN0901353	121,31
	500	400	BBN0901354	132,61
	750	250	BBN0901372	117,98
	750	300	BBN0901373	121,31
	750	400	BBN0901374	132,61
	900	250	BBN0901392	121,17
	900	300	BBN0901393	126,09
	900	400	BBN0901394	144,45
	1000	250	BBN0901312	128,22
	1000	300	BBN0901313	132,21
	1000	400	BBN0901314	147,37

S1 - Steel shelf with steel backedge and 7.5° reverse tilted steel plate brackets - for backedge book support

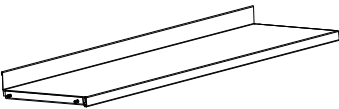
Steel backedge 47 mm.	Module mm	Shelf depth mm	Item no.	Price EUR
	500	250	BBN0901252	83,92
	500	300	BBN0901253	92,31
	500	400	BBN0901254	109,73
	750	250	BBN0901272	83,92
	750	300	BBN0901273	92,31
	750	400	BBN0901274	109,73
	900	250	BBN0901292	87,11
	900	300	BBN0901293	97,09
	900	400	BBN0901294	121,57
	1000	250	BBN0901212	94,16
	1000	300	BBN0901213	103,21
	1000	400	BBN0901214	124,49

SHELVES

S1 - STEEL SHELF & COMPONENTS

S1 - Steel shelf with steel backedge - for backedge book support

Steel backedge 47 mm.
Brackets to be ordered separately, see page 150.

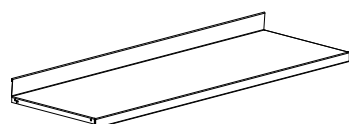

Module mm	Shelf depth mm	Item no.	Price EUR
500	250	B40110525	52,80
500	300	B40110535	56,13
500	400	B40110545	67,43
750	250	B40100127	52,80
750	300	B40100137	56,13
750	400	B40100147	67,43
900	250	B40100129	55,99
900	300	B40100139	60,91
900	400	B40100149	79,27
1000	250	B40100121	63,04
1000	300	B40100131	67,03
1000	400	B40100141	82,19

Backedge book support - for S1

Nickel plated steel, Ø6 mm,
with a nylon glider.

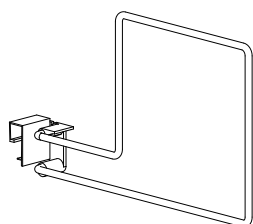

Shelf depth mm	Books left/right of book support	Item no.	Price EUR
250	Left	B4011221	16,89
300	Left	B4011222	18,22
250/300	Left (high)	B4011223	23,67
250	Right	B4011224	16,89
300	Right	B4011225	18,22

SHELVES

S2 - STEEL SHELF

S2 - Steel shelf with acrylic backedge and steel brackets - for hanging book support

Acrylic backedge 17 mm.
Note: Spot welding visible on top of surface.

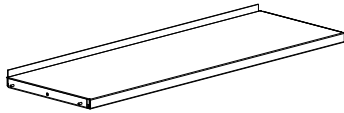

Module mm	Shelf depth mm	Item no.	Price EUR
500	250	BBN0902152	57,06
500	300	BBN0902153	61,72
500	400	BBN0902154	90,98
750	250	BBN0902172	57,06
750	300	BBN0902173	61,72
750	400	BBN0902174	90,98
900	250	BBN0902192	57,06
900	300	BBN0902193	61,72
900	400	BBN0902194	90,98
1000	250	BBN0902112	61,32
1000	300	BBN0902113	67,30
1000	400	BBN0902114	99,76

S2 - Steel shelf with acrylic backedge and 45°/60° steel plate brackets

Acrylic backedge 17 mm.

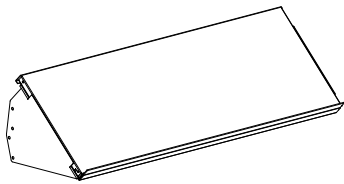

Module mm	Shelf depth mm	Item no.	Price EUR
500	250	BBN0902352	103,88
500	300	BBN0902353	108,54
500	400	BBN0902354	137,80
750	250	BBN0902372	103,88
750	300	BBN0902373	108,54
750	400	BBN0902374	137,80
900	250	BBN0902392	103,88
900	300	BBN0902393	108,54
900	400	BBN0902394	137,80
1000	250	BBN0902312	108,14
1000	300	BBN0902313	114,12
1000	400	BBN0902314	146,58

S2 - Steel shelf with acrylic backedge and 7.5° reverse tilted steel plate brackets

Acrylic backedge 17 mm.

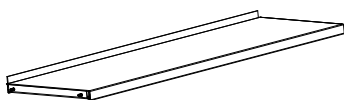

Module mm	Shelf depth mm	Item no.	Price EUR
500	250	BBN0902252	69,82
500	300	BBN0902253	79,54
500	400	BBN0902254	114,92
750	250	BBN0902272	69,82
750	300	BBN0902273	79,54
750	400	BBN0902274	114,92
900	250	BBN0902292	69,82
900	300	BBN0902293	79,54
900	400	BBN0902294	114,92
1000	250	BBN0902212	74,08
1000	300	BBN0902213	85,12
1000	400	BBN0902214	123,70

SHELVES

S2 - STEEL SHELF & COMPONENTS

S2 - Steel shelf with acrylic backedge - for hanging book support

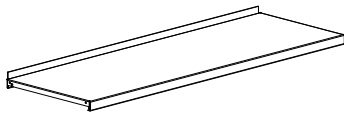
Acrylic backedge 17 mm. Brackets to be ordered separately, see page 150. Note: Spot welding visible on top of surface.	Module mm	Shelf depth mm	Item no.	Price EUR
	500	250	B401106251	38,70
	500	300	B401106351	43,36
	500	400	B401106451	72,62
	750	250	B40101327	38,70
	750	300	B40101337	43,36
	750	400	B40101347	72,62
	900	250	B40101329	38,70
	900	300	B40101339	43,36
	900	400	B40101349	72,62
	1000	250	B40101321	42,96
	1000	300	B40101331	48,94
	1000	400	B40101341	81,40

Hanging book support - for S2

Available in chrome steel or standard steel colours.	Type	Height mm	Item no.	Price EUR
	Normal	200	B4011242	9,04
	Folio	250	B4011245	9,71

Acrylic backedge - for S2

Spare part. H40 mm, 17 mm above shelf. Included when ordering steel shelf with acrylic backedge.	Module	Item no.	Price EUR
	500	B4010145	22,00
	750	B4010127	3,46
	900	B4010129	3,46
	1000	B4010121	3,46

SHELVES

S1 & S2 - COMPONENTS

Steel bracket - for S1 & S2

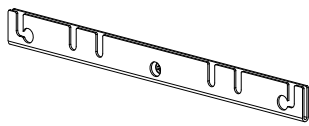

Shelf depth mm
250
300
400

Item no.	Price EUR
BN0842	9,18
BN0843	9,18
BN0844	9,18

45°/60° steel plate bracket - for S1 & S2

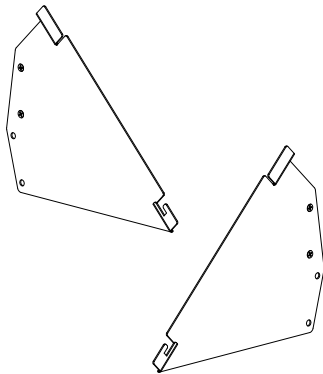

Shelf depth mm	Type
250	Left
250	Right
300	Left
300	Right
400	Left
400	Right

Item no.	Price EUR
BN08828	32,59
BN08829	32,59
BN08838	32,59
BN08839	32,59
BN08848	32,59
BN08849	32,59

7.5° reverse tilted steel plate bracket - for S1 & S2

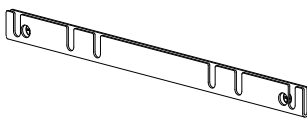

Shelf depth mm
250
300
400

Item no.	Price EUR
BN0862	15,56
BN0863	18,09
BN0864	21,15

SHELVES

S3 - STEEL SHELF

S3 - Steel shelf with steel backedge and pins - for hanging book support

Steel backedge H25 mm.
When turned, the shelf can be used as a sloping shelf by using the existing pins and bracket BN066 (see page 153).

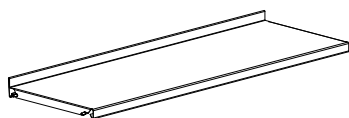

Module mm	Shelf depth mm	Item no.	Price EUR
500	250	BN0655214	38,70
500	300	BN0655314	43,36
500	400	BN0655414	72,62
750	250	BN0657214	38,70
750	300	BN0657314	43,36
750	400	BN0657414	72,62
900	250	BN0659214	38,70
900	300	BN0659314	43,36
900	400	BN0659414	72,62
1000	250	BN0651214	42,96
1000	300	BN0651314	48,94
1000	400	BN0651414	81,40

S3 - Steel shelf with steel backedge, screws and spacers - for hanging book support

Steel backedge H25 mm.

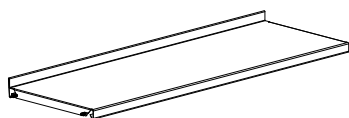

Module mm	Shelf depth mm	Item no.	Price EUR
500	250	BN0655215	38,70
500	300	BN0655315	43,36
500	400	BN0655415	72,62
750	250	BN0657215	38,70
750	300	BN0657315	43,36
750	400	BN0657415	72,62
900	250	BN0659215	38,70
900	300	BN0659315	43,36
900	400	BN0659415	72,62
1000	250	BN0651215	42,96
1000	300	BN0651315	48,94
1000	400	BN0651415	81,40

S3 - Steel shelf with steel backedge, pins and bracket for sloping shelf

Steel backedge H25 mm.

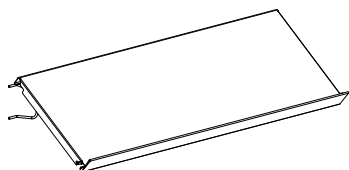

Module mm	Shelf depth mm	Item no.	Price EUR
500	250	BBN0903352	62,10
500	300	BBN0903353	66,76
500	400	BBN0903354	96,02
750	250	BBN0903372	62,10
750	300	BBN0903373	66,76
750	400	BBN0903374	96,02
900	250	BBN0903392	62,10
900	300	BBN0903393	66,76
900	400	BBN0903394	96,02
1000	250	BBN0903312	66,36
1000	300	BBN0903313	72,34
1000	400	BBN0903314	104,80

SHELVES

S3 - COMPONENTS

Hanging book support - for S3, S4 & ST3

Chromed round steel with unbreakable plastic sliders. Easy adjustable.

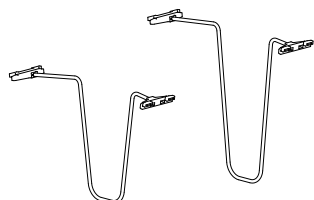

Height mm Shelf depth mm

220 250
220 300

280 250
280 300

Item no.

Price EUR

B40553032
B40553033

11,57
12,24

B40553062
B40553063

12,90
13,83

Bracket for creating sloping shelf - for S3

Chrome round steel. The angle is adjustable, but 45° is recommended. Two brackets required per shelf.

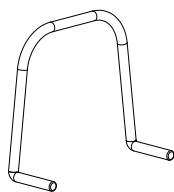

Item no.

Price EUR

BN066

11,70

SHELVES

S4 - STEEL SHELF & COMPONENTS

S4 - Steel shelf with pins - for hanging book support

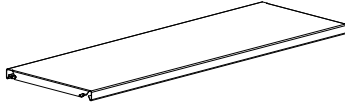
Pins incl.	Module mm	Shelf depth mm	Item no.	Price EUR
	500	250	BN0655204	34,05
	500	300	BN0655304	38,84
	500	400	BN0655404	68,23
	750	250	BN0657204	34,05
	750	300	BN0657304	38,84
	750	400	BN0657404	68,23
	900	250	BN0659204	34,05
	900	300	BN0659304	38,84
	900	400	BN0659404	68,23
	1000	250	BN0651204	38,30
	1000	300	BN0651304	44,42
	1000	400	BN0651404	76,74

S4 - Steel shelf with screws and spacer - for hanging book support

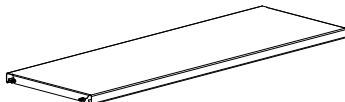
Screws incl.	Module mm	Shelf depth mm	Item no.	Price EUR
	500	250	BN0655205	34,05
	500	300	BN0655305	38,84
	500	400	BN0655405	68,23
	750	250	BN0657205	34,05
	750	300	BN0657305	38,84
	750	400	BN0657405	68,23
	900	250	BN0659205	34,05
	900	300	BN0659305	38,84
	900	400	BN0659405	68,23
	1000	250	BN0651205	38,30
	1000	300	BN0651305	44,42
	1000	400	BN0651405	76,74

Hanging book support - for S3, S4 & ST3

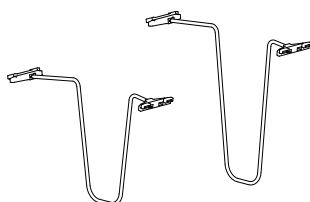
Chromed round steel with unbreakable plastic sliders. Easy adjustable.	Height mm	Shelf depth mm	Item no.	Price EUR
	220	250	B40553032	11,57
	220	300	B40553033	12,24
	280	250	B40553062	12,90
	280	300	B40553063	13,83

SHELVES

ST1 & ST2 - STEEL TOP SHELVES

Choose between a steel or wooden top shelf (placed in between the wooden panels) or an overlaying wooden overlaying top plate (placed on top of the panels).

ST1 - STEEL TOP SHELF

Details:

- Module 500/750/900/1000 mm
- Depth 250/300/400 mm
- Single-sided standard depth
- Single-sided full depth
- Double-sided
- With 25/47 mm frontedge
- Brackets and screws
- Max. weight 25 kg.

Use with:

- S1 - steel shelf for backedge book support
- WP1/2/5/6 - wooden panel
- WBP1/WBP3 - wooden back panel for ST1 standard depth
- WBP2/WBP4 - wooden back panel for ST1 full depth
- WBP2/WBP4 - wooden back panel for ST1 double-sided

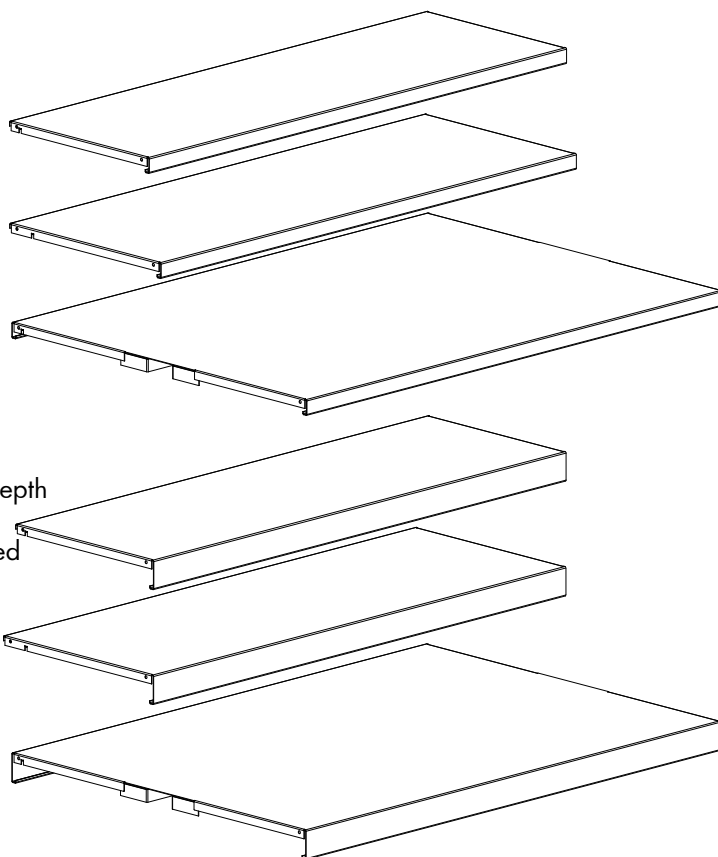

ST2 - STEEL TOP SHELF

Details:

- Module 500/750/900/1000 mm
- Depth 250/300/400 mm
- Single-sided
- With 25 mm frontedge
- Brackets and screws
- Hanging book support
- Max. weight 80 kg

Use with:

- S2 - steel shelf for hanging book support
- WP1/2/5/6 - wooden panel
- WBP1/3 - wooden back panel

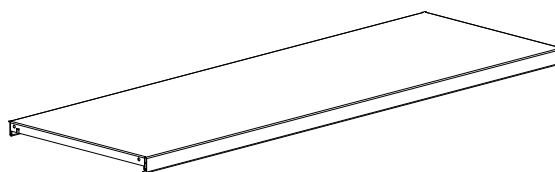

SHELVES

ST3 - STEEL SHELVES

Choose between a steel or wooden top shelf (placed in between the wooden panels) or an overlaying wooden overlaying top plate (placed on top of the panels).

ST3 - STEEL TOP SHELF

Details:

- Module 500/750/900/1000 mm
- Depth 250/300/400 mm
- Single-sided
- With 25 mm frontedge and 50 mm clip-on label holder
- Screws and spacer
- Hanging book support
- Max. weight 80 kg.

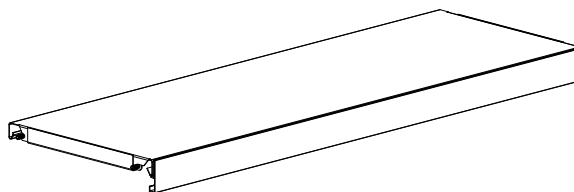

Use with:

- S3 - steel shelf - for hanging book support
- WP1/2/5/6 - wooden panel
- WBP1/3 - wooden back panel

SHELVES

ST1 - STEEL TOP SHELF WITH H25 MM FRONTEDGE AND BRACKETS

ST1 - Single-sided steel top shelf with H25 mm frontedge and brackets - standard depth

To be used with S1.	Module mm	Shelf depth mm	Item no.	Price EUR
	500	250	BBN086152	107,74
	500	300	BBN086153	112,26
	500	400	BBN086154	121,04
	750	250	BBN086172	107,74
	750	300	BBN086173	112,26
	750	400	BBN086174	121,04
	900	250	BBN086192	112,52
	900	300	BBN086193	115,45
	900	400	BBN086194	130,61
	1000	250	BBN086112	119,31
	1000	300	BBN086113	124,23
	1000	400	BBN086114	136,86

ST1 - Single-sided steel top shelf with H25 mm frontedge and brackets - full depth

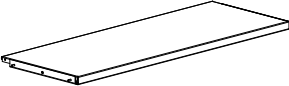
To be used with S1. Only for single-sided shelving.	Module mm	Shelf depth mm	Item no.	Price EUR
	500	250	BBN086352	107,74
	500	300	BBN086353	112,26
	500	400	BBN086354	121,04
	750	250	BBN086372	107,74
	750	300	BBN086373	112,26
	750	400	BBN086374	121,04
	900	250	BBN086392	112,52
	900	300	BBN086393	115,45
	900	400	BBN086394	130,61
	1000	250	BBN086312	119,31
	1000	300	BBN086313	124,23
	1000	400	BBN086314	136,86

ST1 - Double-sided steel top shelf with H25 mm frontedge and brackets

To be used with S1.	Module mm	Shelf depth mm	Item no.	Price EUR
	500	250	BBN086552	215,61
	500	300	BBN086553	224,52
	500	400	BBN086554	242,07
	750	250	BBN086572	215,61
	750	300	BBN086573	224,52
	750	400	BBN086574	242,07
	900	250	BBN086592	225,18
	900	300	BBN086593	230,90
	900	400	BBN086594	261,09
	1000	250	BBN086512	238,48
	1000	300	BBN086513	248,59
	1000	400	BBN086514	273,59

SHELVES

ST1 - STEEL TOP SHELF WITH H25 MM FRONTEDGE

ST1 - Single-sided steel top shelf with H25 mm frontedge - standard depth

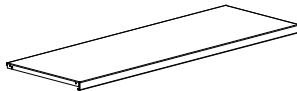
Brackets must be ordered separately. To be used with S1.	Module mm	Shelf depth mm	Item no.	Price EUR
	500	250	BN080522518	89,38
	500	300	BN080532518	93,90
	500	400	BN080542518	102,68
	750	250	BN080722518	89,38
	750	300	BN080732518	93,90
	750	400	BN080742518	102,68
	900	250	BN080922518	94,16
	900	300	BN080932518	97,09
	900	400	BN080942518	112,25
	1000	250	BN080122518	100,95
	1000	300	BN080132518	105,87
	1000	400	BN080142518	118,50

ST1 - Single-sided steel top shelf with H25 mm frontedge - full depth

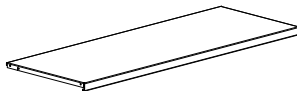
Brackets must be ordered separately. To be used with S1. Only for single-sided shelving.	Module mm	Shelf depth mm	Item no.	Price EUR
	500	250	BN080522519	89,38
	500	300	BN080532519	93,90
	500	400	BN080542519	102,68
	750	250	BN080722519	89,38
	750	300	BN080732519	93,90
	750	400	BN080742519	102,68
	900	250	BN080922519	94,16
	900	300	BN080932519	97,09
	900	400	BN080942519	112,25
	1000	250	BN080122519	100,95
	1000	300	BN080132519	105,87
	1000	400	BN080142519	118,50

ST1 - Double-sided steel top shelf with H25 mm frontedge

Brackets must be ordered separately. To be used with S1.	Module mm	Shelf depth mm	Item no.	Price EUR
	500	250	BN080522528	178,89
	500	300	BN080532528	187,80
	500	400	BN080542528	205,35
	750	250	BN080722528	178,89
	750	300	BN080732528	187,80
	750	400	BN080742528	205,35
	900	250	BN080922528	188,46
	900	300	BN080932528	194,18
	900	400	BN080942528	224,37
	1000	250	BN080122528	201,76
	1000	300	BN080132528	211,87
	1000	400	BN080142528	236,87

SHELVES

ST1 - STEEL TOP SHELF WITH H47 MM FRONTEDGE AND BRACKETS

ST1 - Single-sided steel top shelf with H47 mm frontedge and brackets - standard depth

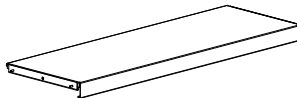
To be used with S1.	Module mm	Shelf depth mm	Item no.	Price EUR
	500	250	BBN086252	107,74
	500	300	BBN086253	112,26
	500	400	BBN086254	121,04
	750	250	BBN086272	107,74
	750	300	BBN086273	112,26
	750	400	BBN086274	121,04
	900	250	BBN086292	112,52
	900	300	BBN086293	115,45
	900	400	BBN086294	130,61
	1000	250	BBN086212	119,31
	1000	300	BBN086213	124,23
	1000	400	BBN086214	136,86

ST1 - Single-sided steel top shelf with H47 mm frontedge and brackets - full depth

To be used with S1. Only for single-sided shelving.	Module mm	Shelf depth mm	Item no.	Price EUR
	500	250	BBN086452	107,74
	500	300	BBN086453	112,26
	500	400	BBN086454	121,04
	750	250	BBN086472	107,74
	750	300	BBN086473	112,26
	750	400	BBN086474	121,04
	900	250	BBN086492	112,52
	900	300	BBN086493	115,45
	900	400	BBN086494	130,61
	1000	250	BBN086412	119,31
	1000	300	BBN086413	124,23
	1000	400	BBN086414	136,86

ST1 - Double-sided steel top shelf with H47 mm frontedge and brackets

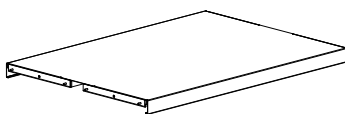
To be used with S1.	Module mm	Shelf depth mm	Item no.	Price EUR
	500	250	BBN086652	215,61
	500	300	BBN086653	224,52
	500	400	BBN086654	242,07
	750	250	BBN086672	215,61
	750	300	BBN086673	224,52
	750	400	BBN086674	242,07
	900	250	BBN086692	225,18
	900	300	BBN086693	230,90
	900	400	BBN086694	261,09
	1000	250	BBN086612	238,48
	1000	300	BBN086613	248,59
	1000	400	BBN086614	273,59

SHELVES

ST1 - STEEL TOP SHELF WITH H47 MM FRONTEDGE

ST1 - Single-sided steel top shelf with H47 mm frontedge - standard depth

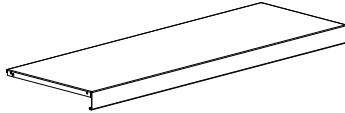
Brackets must be ordered separately. To be used with S1.	Module mm	Shelf depth mm	Item no.	Price EUR
	500	250	BN080524718	89,38
	500	300	BN080534718	93,90
	500	400	BN080544718	102,68
	750	250	BN080724718	89,38
	750	300	BN080734718	93,90
	750	400	BN080744718	102,68
	900	250	BN080924718	94,16
	900	300	BN080934718	97,09
	900	400	BN080944718	112,25
	1000	250	BN080124718	100,95
	1000	300	BN080134718	105,87
	1000	400	BN080144718	118,50

ST1 - Single-sided steel top shelf with H47 mm frontedge - full depth

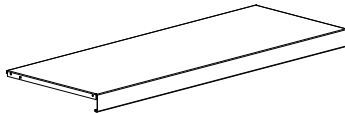
Brackets must be ordered separately. To be used with S1. Only for single-sided shelving.	Module mm	Shelf depth mm	Item no.	Price EUR
	500	250	BN080524719	89,38
	500	300	BN080534719	93,90
	500	400	BN080544719	102,68
	750	250	BN080724719	89,38
	750	300	BN080734719	93,90
	750	400	BN080744719	102,68
	900	250	BN080924719	94,16
	900	300	BN080934719	97,09
	900	400	BN080944719	112,25
	1000	250	BN080124719	100,95
	1000	300	BN080134719	105,87
	1000	400	BN080144719	118,50

ST1 - Double-sided steel top shelf with H47 mm frontedge

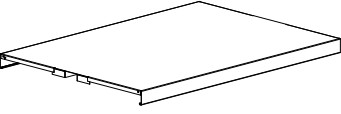
Brackets must be ordered separately. To be used with S1.	Module mm	Shelf depth mm	Item no.	Price EUR
	500	250	BN080524728	178,89
	500	300	BN080534728	187,80
	500	400	BN080544728	205,35
	750	250	BN080724728	178,89
	750	300	BN080734728	187,80
	750	400	BN080744728	205,35
	900	250	BN080924728	188,46
	900	300	BN080934728	194,18
	900	400	BN080944728	224,37
	1000	250	BN080124728	201,76
	1000	300	BN080134728	211,87
	1000	400	BN080144728	236,87

SHELVES

ST2 - STEEL TOP SHELF & COMPONENTS

ST2 - Single-sided steel top shelf with brackets - standard depth - for hanging book support

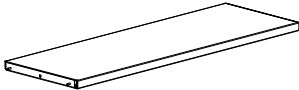
To be used with S2.	Module mm	Shelf depth mm	Item no.	Price EUR
	500	250	BBN086752	53,21
	500	300	BBN086753	58,13
	500	400	BBN086754	87,52
	750	250	BBN086772	52,54
	750	300	BBN086773	57,06
	750	400	BBN086774	90,98
	900	250	BBN086792	52,54
	900	300	BBN086793	57,06
	900	400	BBN086794	90,98
	1000	250	BBN086712	61,05
	1000	300	BBN086713	61,32
	1000	400	BBN086714	99,76

ST2 - Single-sided steel top shelf - standard depth - for hanging book support

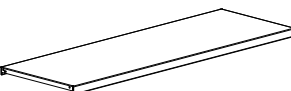
Brackets must be ordered separately. To be used with S2.	Module mm	Shelf depth mm	Item no.	Price EUR
	500	250	B401106250	34,85
	500	300	B401106350	39,77
	500	400	B401106450	69,16
	750	250	B40101127	34,18
	750	300	B40101137	38,70
	750	400	B40101147	72,62
	900	250	B40101129	34,18
	900	300	B40101139	38,70
	900	400	B40101149	72,62
	1000	250	B40101121	42,69
	1000	300	B40101131	42,96
	1000	400	B40101141	81,40

Hanging book support - for S2 & ST2

Available in chrome steel or standard steel colours.	Type	Height mm	Item no.	Price EUR
	Normal	200	B4011242	9,04
	Folio	250	B4011245	9,71

SHELVES

ST1 & ST2 - COMPONENTS

Steel bracket - for ST1 & ST2

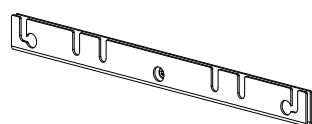

Shelf depth mm	Item no.	Price EUR
250	BN0842	9,18
300	BN0843	9,18
400	BN0844	9,18

Shelf bridge - for ST1 & ST2

Used to minimize gap between ST1/ST2 on double-sided shelving.



Shelf	Module	Item no.	Price EUR
ST1 w/25 mm front	500	BN04015	33,25
ST1 w/25 mm front	750	BN04017	33,25
ST1 w/25 mm front	900	BN04019	33,25
ST1 w/25 mm front	1000	BN04011	36,84
ST1 w/47 mm front	500	BN04025	33,25
ST1 w/47 mm front	750	BN04027	33,25
ST1 w/47 mm front	900	BN04029	33,25
ST1 w/47 mm front	1000	BN04021	36,84
ST2	500	BN04075	33,25
ST2	750	BN04077	33,25
ST2	900	BN04079	33,25
ST2	1000	BN04071	36,84

SHELVES

ST3 - STEEL TOP SHELF WITH CLIP-ON LABEL HOLDER & COMPONENTS

ST3 - Single-sided steel top shelf with screws, spacer and clip on label holder - for hanging book support

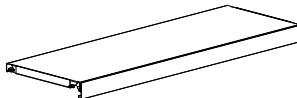
H50 mm plastic clip-on label holder. To be used with S3 and S4.	Module mm	Shelf depth mm	Item no.	Price EUR
	500	250	BBN08452	67,43
	500	300	BBN08453	72,22
	500	400	BBN08454	101,61
	750	250	BBN08472	67,43
	750	300	BBN08473	72,22
	750	400	BBN08474	101,61
	900	250	BBN08492	67,43
	900	300	BBN08493	72,22
	900	400	BBN08494	101,61
	1000	250	BBN08412	71,68
	1000	300	BBN08413	77,80
	1000	400	BBN08414	110,12

S4 - Steel shelf with screws and spacer - for hanging book support

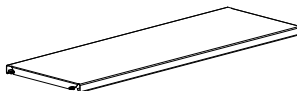
Steel shelf can be used as steel top shelf.	Module mm	Shelf depth mm	Item no.	Price EUR
	500	250	BN0655205	34,05
	500	300	BN0655305	38,84
	500	400	BN0655405	68,23
	750	250	BN0657205	34,05
	750	300	BN0657305	38,84
	750	400	BN0657405	68,23
	900	250	BN0659205	34,05
	900	300	BN0659305	38,84
	900	400	BN0659405	68,23
	1000	250	BN0651205	38,30
	1000	300	BN0651305	44,42
	1000	400	BN0651405	76,74

Hanging book support - for S3, S4 & ST3

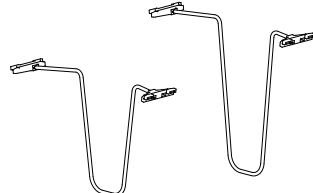
Chromed round steel with unbreakable plastic sliders. Easy adjustable.	Height mm	Shelf depth mm	Item no.	Price EUR
	220	250	B40553032	11,57
	220	300	B40553033	12,24
	280	250	B40553062	12,90
	280	300	B40553063	13,83

SHELVES

W1 & W2 - WOODEN SHELVES

See below for overview of standard wooden shelves:

W1 - WOODEN SHELF WITH H47 MM STEEL BACKEDGE - FOR BACKEDGE BOOK SUPPORT

Details:

- Module 500/750/900 mm
- Depth 250/300/400 mm
- Painted/veneer
- Steel backedge H47 mm for backedge book support
- Snapfix for intermediate shelf/
snapfix and screws for bottom shelf
- Max. weight 80 kg.
- Blockboard
- Straight

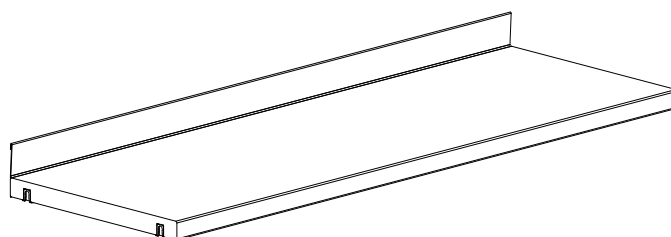

Use with:

- S1 - steel shelf
- ST1 - steel top shelf
- WT1 - wooden top shelf
- WO1 - wooden overlaying top plate

Note:

- Wooden shelves placed at the bottom, must always be fixed with snapfix and screws.
 - Shelving H1820 and 2120 with cross brace must always have one intermediate shelf fixed with snapfix and screws.
-

W2 - WOODEN SHELF

Details:

- Module 500/750/900 mm
- Depth 250/300/400 mm
- Painted/veneer
- No backedge
- Snapfix for intermediate shelf/
snapfix and screws for bottom shelf
- Max. weight 80 kg.
- Blockboard
- Straight

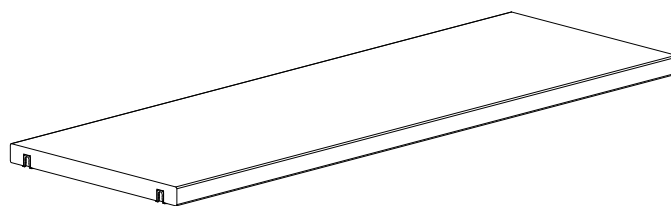

Use with:

- S2 - steel shelf
- ST2 - steel top shelf
- WT1 - wooden top shelf
- WO1 - wooden overlaying top plate

Note:

- Wooden shelves placed at the bottom, must always be fixed with snapfix and screws.
 - Shelving H1820 and 2120 with cross brace must always have one intermediate shelf fixed with snapfix and screws.
-

SHELVES

W3 & W4 - WOODEN SHELVES

See below for overview of standard wooden shelves:

W3 - WOODEN SHELF WITH H47 MM STEEL BACKEDGE

Details:

- Module 500/750/900/1000 mm
- Depth 250/300/400 mm
- Melamine/laminate
- Steel backedge H47 mm
- With/without groove for clip-on label holder
- Snapfix for intermediate shelf/
snapfix and screws for bottom shelf
- Max. weight 60 kg.
- Particleboard/blockboard
- Straight

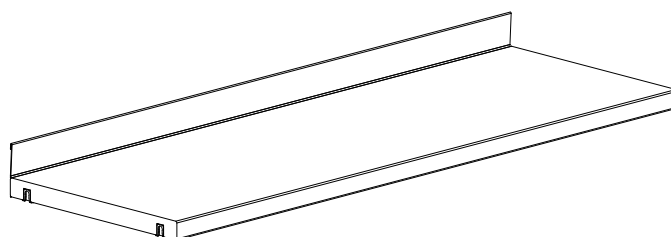

Use with:

- S3/S4 - steel shelf
- ST3 - steel top shelf
- WT1 - wooden top shelf
- WO1 - wooden overlaying top plate

Note:

- Wooden shelves placed at the bottom, must always be fixed with snapfix and screws.
 - Shelving H1820 and 2120 with cross brace must always have one intermediate shelf fixed with snapfix and screws.
-

W4 - WOODEN SHELF

Details:

- Module 500/750/900/1000 mm
- Depth 250/300/400 mm
- Melamine/laminate
- No backedge
- With/without groove for clip-on label holder
- Snapfix for intermediate shelf/
snapfix and screws for bottom shelf
- Max. weight 60 kg.
- Particleboard/blockboard
- Straight

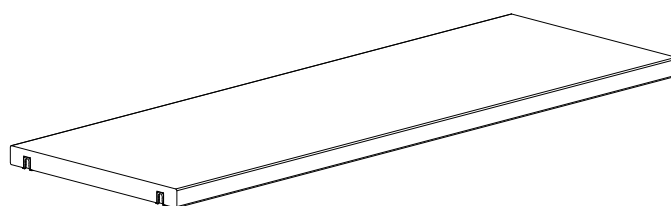

Use with:

- S3/S4 - steel shelf
- ST3 - steel top shelf
- WT1 - wooden top shelf
- WO1 - wooden overlaying top plate

Note:

- Wooden shelves placed at the bottom, must always be fixed with snapfix and screws.
 - Shelving H1820 and 2120 with cross brace must always have one intermediate shelf fixed with snapfix and screws.
-

SHELVES

W1 - WOODEN SHELF WITH H47 MM BACKEDGE AND COMPONENTS

Painted and veneered shelves are FSC-certified.

W1 - intermediate, wooden shelf with steel backedge and snapfix - for backedge book support

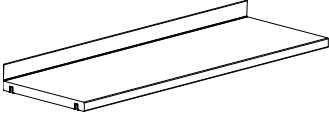
H47 mm steel backedge. Blockboard. Incl. fittings (snapfix).	Module mm	Shelf depth mm	Item no.	Melamine EUR	Painted EUR	Veneer EUR
	500	250	BN067521.ZZZZZZZZ3	-	67,17	93,90
	500	300	BN067531.ZZZZZZZZ3	-	67,17	93,90
	500	400	BN067541.ZZZZZZZZ3	-	79,93	111,85
	750	250	BN067721.ZZZZZZZZ3	-	100,55	140,85
	750	300	BN067731.ZZZZZZZZ3	-	100,55	140,85
	750	400	BN067741.ZZZZZZZZ3	-	119,97	167,58
	900	250	BN067921.ZZZZZZZZ3	-	102,81	143,64
	900	300	BN067931.ZZZZZZZZ3	-	102,81	143,64
	900	400	BN067941.ZZZZZZZZ3	-	121,83	170,51

W1 - bottom, wooden shelf with steel backedge, snapfix and screws - for backedge book support

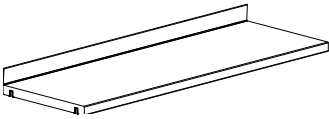
H47 mm steel backedge. Blockboard. Incl. fittings (snapfix and screws).	Module mm	Shelf depth mm	Item no.	Melamine EUR	Painted EUR	Veneer EUR
	500	250	BN067521.ZZZZZZZZ2	-	67,17	93,90
	500	300	BN067531.ZZZZZZZZ2	-	67,17	93,90
	500	400	BN067541.ZZZZZZZZ2	-	79,93	111,85
	750	250	BN067721.ZZZZZZZZ2	-	100,55	140,85
	750	300	BN067731.ZZZZZZZZ2	-	100,55	140,85
	750	400	BN067741.ZZZZZZZZ2	-	119,97	167,58
	900	250	BN067921.ZZZZZZZZ2	-	102,81	143,64
	900	300	BN067931.ZZZZZZZZ2	-	102,81	143,64
	900	400	BN067941.ZZZZZZZZ2	-	121,83	170,51

Backedge book support - for W1

Nickel plated steel, Ø6 mm, with a nylon glider.	Shelf depth mm	Books left/right of book support	Item no.	Price EUR
	250	Left	B4011221	16,89
	300	Left	B4011222	18,22
	250/300	Left (high)	B4011223	23,67
	250	Right	B4011224	16,89
	300	Right	B4011225	18,22

SHELVES

W2 - WOODEN SHELF AND COMPONENTS

Painted and veneered shelves are FSC-certified.

W2 - intermediate, wooden shelf without backedge, with snapfix

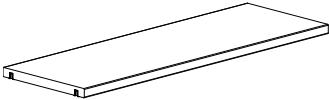
Blockboard. Incl. fittings (snapfix).	Module mm	Shelf depth mm	Item no.	Melamine EUR	Painted EUR	Veneer EUR
	500	250	BN067520.ZZZZZZZZ3	-	59,98	84,19
	500	300	BN067530.ZZZZZZZZ3	-	59,98	84,19
	500	400	BN067540.ZZZZZZZZ3	-	72,88	101,61
	750	250	BN067720.ZZZZZZZZ3	-	90,04	126,08
	750	300	BN067730.ZZZZZZZZ3	-	90,04	126,08
	750	400	BN067740.ZZZZZZZZ3	-	109,19	152,82
	900	250	BN067920.ZZZZZZZZ3	-	90,04	126,08
	900	300	BN067930.ZZZZZZZZ3	-	90,04	126,08
	900	400	BN067940.ZZZZZZZZ3	-	109,19	152,82

W2 - bottom, wooden shelf without backedge, with snapfix and screws

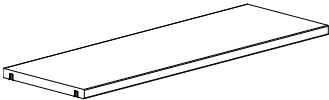
Blockboard. Incl. fittings (snapfix and screws).	Module mm	Shelf depth mm	Item no.	Melamine EUR	Painted EUR	Veneer EUR
	500	250	BN067520.ZZZZZZZZ2	-	59,98	84,19
	500	300	BN067530.ZZZZZZZZ2	-	59,98	84,19
	500	400	BN067540.ZZZZZZZZ2	-	72,88	101,61
	750	250	BN067720.ZZZZZZZZ2	-	90,04	126,08
	750	300	BN067730.ZZZZZZZZ2	-	90,04	126,08
	750	400	BN067740.ZZZZZZZZ2	-	109,19	152,82
	900	250	BN067920.ZZZZZZZZ2	-	90,04	126,08
	900	300	BN067930.ZZZZZZZZ2	-	90,04	126,08
	900	400	BN067940.ZZZZZZZZ2	-	109,19	152,82

Hanging book support - for S2 and W2/4 with rail

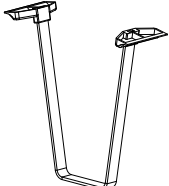
Available in chrome steel or standard steel colours.	Type	Height mm	Item no.	Price EUR
	Normal	200	B4011242	9,04
	Folio	250	B4011245	9,71

Rail for fixing hanging book support under W2 & W4

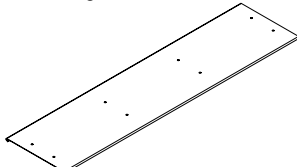
Fix underneath wooden shelf. For book support B40112x. Incl. fittings	Module	Item no.	Price EUR
	750	B4022007	32,45
	900	B4022009	32,45

SHELVES

W3 - WOODEN SHELF WITH H47 MM BACKEDGE

W3 - intermediate, wooden shelf with steel backedge, with snapfix, without groove for clip-on label holder

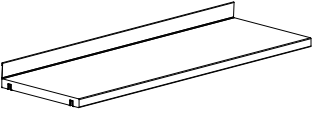
H47 mm steel backedge. Particleboard. Incl. fittings (snapfix)	Module mm	Shelf depth mm	Item no.	Melamine EUR	Painted EUR	Veneer EUR
	500	250	BN07052106ZZZZZ3	50,81	-	-
	500	300	BN07053106ZZZZZ3	50,81	-	-
	500	400	BN07054106ZZZZZ3	61,71	-	-
	750	250	BN07072106ZZZZZ3	76,61	-	-
	750	300	BN07073106ZZZZZ3	76,61	-	-
	750	400	BN07074106ZZZZZ3	92,70	-	-
	900	250	BN07092106ZZZZZ3	76,61	-	-
	900	300	BN07093106ZZZZZ3	76,61	-	-
	900	400	BN07094106ZZZZZ3	92,70	-	-

W3 - intermediate, wooden shelf with steel backedge, with snapfix, without groove for clip-on label holder

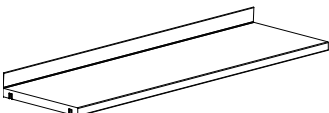
H47 mm steel backedge. Blockboard. Incl. fittings (snapfix)	Module mm	Shelf depth mm	Item no.	Laminate EUR	Painted EUR	Veneer EUR
	1000	250	BN07012103ZZZZZ3	139,65	-	-
	1000	300	BN07013103ZZZZZ3	139,65	-	-
	1000	400	BN07014103ZZZZZ3	168,91	-	-

W3 - intermediate, wooden shelf with steel backedge, with snapfix, with groove for clip-on label holder

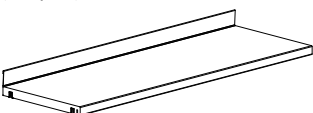
H47 mm steel backedge. Particleboard. Incl. fittings (snapfix)	Module mm	Shelf depth mm	Item no.	Melamine EUR	Painted EUR	Veneer EUR
	500	250	BN07052116ZZZZZ3	52,54	-	-
	500	300	BN07053116ZZZZZ3	52,54	-	-
	500	400	BN07054116ZZZZZ3	63,18	-	-
	750	250	BN07072116ZZZZZ3	78,07	-	-
	750	300	BN07073116ZZZZZ3	78,07	-	-
	750	400	BN07074116ZZZZZ3	94,16	-	-
	900	250	BN07092116ZZZZZ3	78,07	-	-
	900	300	BN07093116ZZZZZ3	78,07	-	-
	900	400	BN07094116ZZZZZ3	94,16	-	-

W3 - intermediate, wooden shelf with steel backedge, with snapfix, with groove for clip-on label holder

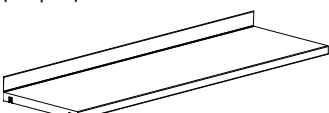
H47 mm steel backedge. Blockboard. Incl. fittings (snapfix)	Module mm	Shelf depth mm	Item no.	Laminate EUR	Painted EUR	Veneer EUR
	1000	250	BN07012113ZZZZZ3	142,31	-	-
	1000	300	BN07013113ZZZZZ3	142,31	-	-
	1000	400	BN07014113ZZZZZ3	171,57	-	-

SHELVES

W3 - WOODEN SHELF WITH H47 MM BACKEDGE

W3 - bottom, wooden shelf with steel backedge, with snapfix and screws, without groove for clip-on label holder

H47 mm steel backedge. Particleboard. Incl. fittings (snapfix and screws).	Module mm	Shelf depth mm	Item no.	Melamine EUR	Painted EUR	Veneer EUR
	500	250	BN07052106ZZZZZZ2	50,81	-	-
	500	300	BN07053106ZZZZZZ2	50,81	-	-
	500	400	BN07054106ZZZZZZ2	61,71	-	-
	750	250	BN07072106ZZZZZZ2	76,61	-	-
	750	300	BN07073106ZZZZZZ2	76,61	-	-
	750	400	BN07074106ZZZZZZ2	92,70	-	-
	900	250	BN07092106ZZZZZZ2	76,61	-	-
	900	300	BN07093106ZZZZZZ2	76,61	-	-
	900	400	BN07094106ZZZZZZ2	92,70	-	-

W3 - bottom, wooden shelf with steel backedge, with snapfix and screws, without groove for clip-on label holder

H47 mm steel backedge. Blockboard. Incl. fittings (snapfix and screws).	Module mm	Shelf depth mm	Item no.	Laminate EUR	Painted EUR	Veneer EUR
	1000	250	BN07012103ZZZZZZ2	139,65	-	-
	1000	300	BN07013103ZZZZZZ2	139,65	-	-
	1000	400	BN07014103ZZZZZZ2	168,91	-	-

W3 - bottom, wooden shelf with steel backedge, with snapfix and screws, with groove for clip-on label holder

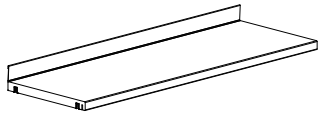
H47 mm steel backedge. Particleboard. Incl. fittings (snapfix and screws).	Module mm	Shelf depth mm	Item no.	Melamine EUR	Painted EUR	Veneer EUR
	500	250	BN07052116ZZZZZZ2	52,54	-	-
	500	300	BN07053116ZZZZZZ2	52,54	-	-
	500	400	BN07054116ZZZZZZ2	63,18	-	-
	750	250	BN07072116ZZZZZZ2	78,07	-	-
	750	300	BN07073116ZZZZZZ2	78,07	-	-
	750	400	BN07074116ZZZZZZ2	94,16	-	-
	900	250	BN07092116ZZZZZZ2	78,07	-	-
	900	300	BN07093116ZZZZZZ2	78,07	-	-
	900	400	BN07094116ZZZZZZ2	94,16	-	-

W3 - bottom, wooden shelf with steel backedge, with snapfix and screws, with groove for clip-on label holder

H47 mm steel backedge. Blockboard. Incl. fittings (snapfix and screws).	Module mm	Shelf depth mm	Item no.	Laminate EUR	Painted EUR	Veneer EUR
	1000	250	BN07012113ZZZZZZ2	142,31	-	-
	1000	300	BN07013113ZZZZZZ2	142,31	-	-
	1000	400	BN07014113ZZZZZZ2	171,57	-	-

SHELVES

W4 - WOODEN SHELF

W4 - intermediate, wooden shelf without backedge, with snapfix, without groove for clip-on label holder

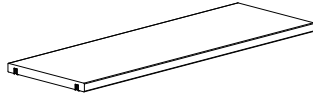
Particleboard. Incl. fittings (snapfix)	Module mm	Shelf depth mm	Item no.	Melamine EUR	Painted EUR	Veneer EUR
	500	250	BN07052006ZZZZZ3	44,42	-	-
	500	300	BN07053006ZZZZZ3	44,42	-	-
	500	400	BN07054006ZZZZZ3	55,46	-	-
	750	250	BN07072006ZZZZZ3	67,03	-	-
	750	300	BN07073006ZZZZZ3	67,03	-	-
	750	400	BN07074006ZZZZZ3	83,26	-	-
	900	250	BN07092006ZZZZZ3	65,30	-	-
	900	300	BN07093006ZZZZZ3	65,30	-	-
	900	400	BN07094006ZZZZZ3	81,13	-	-

W4 - intermediate, wooden shelf without backedge, with snapfix, without groove for clip-on label holder

Blockboard. Incl. fittings (snapfix)	Module mm	Shelf depth mm	Item no.	Laminate EUR	Painted EUR	Veneer EUR
	1000	250	BN07012003ZZZZZ3	119,04	-	-
	1000	300	BN07013003ZZZZZ3	119,04	-	-
	1000	400	BN07014003ZZZZZ3	1.477,90	-	-

W4 - intermediate, wooden shelf without backedge, with snapfix, with groove for clip-on label holder

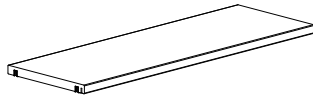
Particleboard. Incl. fittings (snapfix)	Module mm	Shelf depth mm	Item no.	Melamine EUR	Painted EUR	Veneer EUR
	500	250	BN07052016ZZZZZ3	46,15	-	-
	500	300	BN07053016ZZZZZ3	46,15	-	-
	500	400	BN07054016ZZZZZ3	56,79	-	-
	750	250	BN07072016ZZZZZ3	68,50	-	-
	750	300	BN07073016ZZZZZ3	68,50	-	-
	750	400	BN07074016ZZZZZ3	84,59	-	-
	900	250	BN07092016ZZZZZ3	66,50	-	-
	900	300	BN07093016ZZZZZ3	66,50	-	-
	900	400	BN07094016ZZZZZ3	82,86	-	-

W4 - intermediate, wooden shelf without backedge, with snapfix, with groove for clip-on label holder

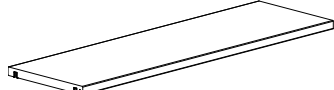
Blockboard. Incl. fittings (snapfix)	Module mm	Shelf depth mm	Item no.	Laminate EUR	Painted EUR	Veneer EUR
	1000	250	BN07012013ZZZZZ3	121,16	-	-
	1000	300	BN07013013ZZZZZ3	121,16	-	-
	1000	400	BN07014013ZZZZZ3	150,96	-	-

SHELVES

W4 - WOODEN SHELF

W4 - bottom, wooden shelf without backedge, with snapfix and screws, without groove for clip-on label holder

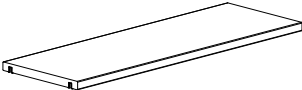
Particleboard. Incl. fittings (snapfix and screws).	Module mm	Shelf depth mm	Item no.	Melamine EUR	Painted EUR	Veneer EUR
	500	250	BN07052006ZZZZZZ2	44,42	-	-
	500	300	BN07053006ZZZZZZ2	44,42	-	-
	500	400	BN07054006ZZZZZZ2	55,46	-	-
	750	250	BN07072006ZZZZZZ2	67,03	-	-
	750	300	BN07073006ZZZZZZ2	67,03	-	-
	750	400	BN07074006ZZZZZZ2	83,26	-	-
	900	250	BN07092006ZZZZZZ2	65,30	-	-
	900	300	BN07093006ZZZZZZ2	65,30	-	-
	900	400	BN07094006ZZZZZZ2	81,13	-	-

W4 - bottom, wooden shelf without backedge, with snapfix and screws, without groove for clip-on label holder

Blockboard. Incl. fittings (snapfix and screws).	Module mm	Shelf depth mm	Item no.	Laminate EUR	Painted EUR	Veneer EUR
	1000	250	BN07012003ZZZZZZ2	119,04	-	-
	1000	300	BN07013003ZZZZZZ2	119,04	-	-
	1000	400	BN07014003ZZZZZZ2	1.477,90	-	-

W4 - bottom, wooden shelf without backedge, with snapfix and screws, with groove for clip-on label holder

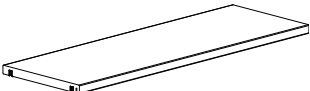
Particleboard. Incl. fittings (snapfix and screws).	Module mm	Shelf depth mm	Item no.	Melamine EUR	Painted EUR	Veneer EUR
	500	250	BN07052016ZZZZZZ2	46,15	-	-
	500	300	BN07053016ZZZZZZ2	46,15	-	-
	500	400	BN07054016ZZZZZZ2	56,79	-	-
	750	250	BN07072016ZZZZZZ2	68,50	-	-
	750	300	BN07073016ZZZZZZ2	68,50	-	-
	750	400	BN07074016ZZZZZZ2	84,59	-	-
	900	250	BN07092016ZZZZZZ2	66,50	-	-
	900	300	BN07093016ZZZZZZ2	66,50	-	-
	900	400	BN07094016ZZZZZZ2	82,86	-	-

W4 - bottom, wooden shelf without backedge, with snapfix and screws, with groove for clip-on label holder

Blockboard. Incl. fittings (snapfix and screws).	Module mm	Shelf depth mm	Item no.	Laminate EUR	Painted EUR	Veneer EUR
	1000	250	BN07012013ZZZZZZ2	121,16	-	-
	1000	300	BN07013013ZZZZZZ2	121,16	-	-
	1000	400	BN07014013ZZZZZZ2	150,96	-	-

SHELVES

WT1 - WOODEN TOP SHELVES

Choose between a steel or wooden top shelf (placed in between the wooden panels) or a wooden overlaying top plate (placed on top of the panels).

WT1 - WOODEN TOP SHELF

Details:

- Module 500/750/900/1000 mm
- Depth 250/300/400 mm
- Painted/veneer
- Single-sided standard depth
- Single-sided full depth
- Double-sided
- Snapfix and screws
- Max. weight 100 kg. (Norm EN14073-3)
- Particleboard

Use with:

- S1/S2/S3/S4 - steel shelves
- W1/W2/W3/W4 - wooden shelves
- WP1/2/5/6 - wooden panel
- WBP1/WBP3 - wooden back panel for standard depth
- WBP2/WBP4 - wooden back panel for full depth
- WBP2/WBP4 - wooden back panel for double-sided

Note:

- Wooden top shelves must always be fixed with snapfix and screws.

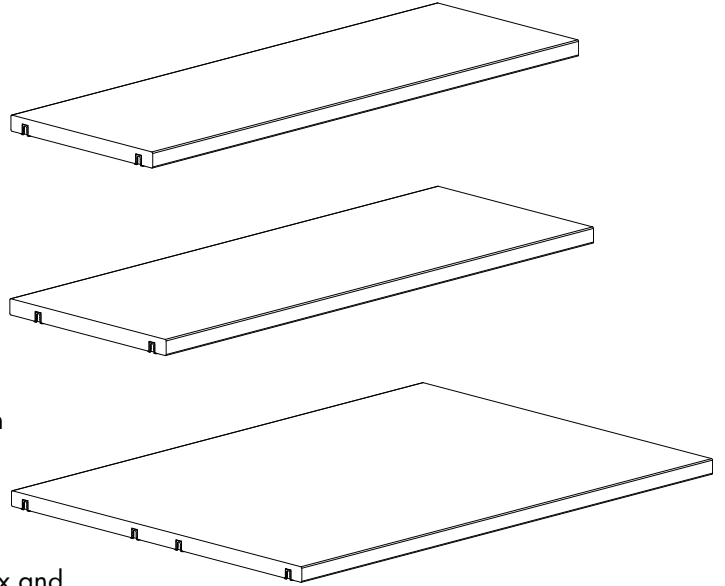

SHELVES

WT3 - WOODEN TOP SHELVES

Choose between a steel or wooden top shelf (placed in between the wooden panels) or a wooden overlaying top plate (placed on top of the panels).

WT3 - WOODEN TOP SHELF

Details:

- Module 500/750/900/1000 mm
- Depth 250/300/400 mm
- Melamine
- Single-sided standard depth
- Single-sided full depth
- Double-sided
- Snapfix and screws
- Max. weight 100 kg. (Norm EN14073-3)
- Particleboard

Use with:

- S1/S2/S3/S4 - steel shelves
- W1/W2/W3/W4 - wooden shelves
- WP1/2/5/6 - wooden panel
- WBP1/WBP3 - wooden back panel for standard depth
- WBP2/WBP4 - wooden back panel for full depth
- WBP2/WBP4 - wooden back panel for double-sided

Note:

- Wooden top shelves must always be fixed with snapfix and screws.

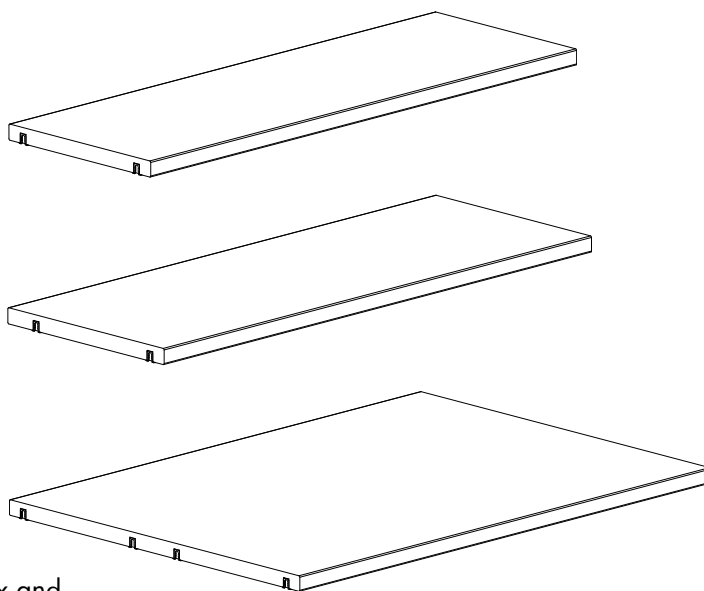

SHELVES

WT1 - WOODEN TOP SHELF - PAINTED/VENEER

Painted and veneered shelves are FSC-certified.

WT1 - single-sided wooden top shelf - standard depth

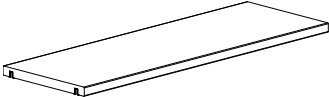
Particleboard. Incl. fittings (snapfix and screws).	Module mm	Shelf depth mm	Item no.	Melamine EUR	Painted EUR	Veneer EUR
	500	250	BN0765218.	-	67,83	95,23
	500	300	BN0765318.	-	75,54	106,00
	500	400	BN0765418.	-	85,79	119,83
	750	250	BN0767218.	-	102,14	142,84
	750	300	BN0767318.	-	113,58	158,94
	750	400	BN0767418.	-	128,61	179,95
	900	250	BN0769218.	-	102,14	142,84
	900	300	BN0769318.	-	113,58	158,94
	900	400	BN0769418.	-	128,61	179,95
	1000	250	BN0761218.	-	114,51	160,13
	1000	300	BN0761318.	-	126,48	177,02
	1000	400	BN0761418.	-	143,77	201,76

WT1 - single-sided wooden top shelf - full depth

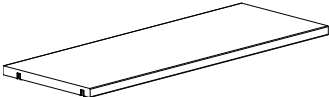
Particleboard. Incl. fittings (snapfix and screws).	Module mm	Shelf depth mm	Item no.	Melamine EUR	Painted EUR	Veneer EUR
	500	250 = 280	BN0765219.	-	67,83	95,23
	500	300 = 330	BN0765319.	-	75,54	106,00
	500	400 = 430	BN0765419.	-	85,79	119,83
	750	250 = 280	BN0767219.	-	102,14	142,84
	750	300 = 330	BN0767319.	-	113,58	158,94
	750	400 = 430	BN0767419.	-	128,61	179,95
	900	250 = 280	BN0769219.	-	102,14	142,84
	900	300 = 330	BN0769319.	-	113,58	158,94
	900	400 = 430	BN0769419.	-	128,61	179,95
	1000	250 = 280	BN0761219.	-	114,51	160,13
	1000	300 = 330	BN0761319.	-	126,48	177,02
	1000	400 = 430	BN0761419.	-	143,77	201,76

WT1 - double-sided wooden top shelf

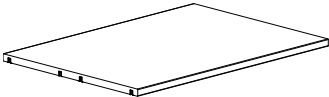
Particleboard. Incl. fittings (snapfix and screws).	Module mm	Shelf depth mm	Item no.	Melamine EUR	Painted EUR	Veneer EUR
	500	2 x 250 = 537	BN0765228.	-	90,84	127,15
	500	2 x 300 = 637	BN0765328.	-	139,25	194,85
	500	2 x 400 = 837	BN0765428.	-	212,53	297,26
	750	2 x 250 = 537	BN0767228.	-	136,19	190,46
	750	2 x 300 = 637	BN0767328.	-	208,94	292,47
	750	2 x 400 = 837	BN0767428.	-	318,67	445,95
	900	2 x 250 = 537	BN0769228.	-	136,19	190,46
	900	2 x 300 = 637	BN0769328.	-	208,94	292,47
	900	2 x 400 = 837	BN0769428.	-	318,67	445,95
	1000	2 x 250 = 537	BN0761228.	-	151,49	211,87
	1000	2 x 300 = 637	BN0761328.	-	232,35	324,92
	1000	2 x 400 = 837	BN0761428.	-	354,18	495,69

SHELVES

WT3 - WOODEN TOP SHELF - MELAMINE

WT3 - Single-sided wooden top shelf - standard depth

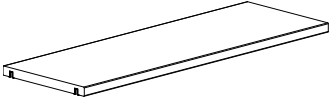
Particleboard. Incl. fittings (snapfix and screws).	Module mm	Shelf depth mm	Item no.	Melamine EUR	Painted EUR	Veneer EUR
	500	250	BN07752186	57,59	-	-
	500	300	BN07753186	64,51	-	-
	500	400	BN07754186	72,88	-	-
	750	250	BN07772186	86,72	-	-
	750	300	BN07773186	96,43	-	-
	750	400	BN07774186	109,19	-	-
	900	250	BN07792186	86,72	-	-
	900	300	BN07793186	96,43	-	-
	900	400	BN07794186	109,19	-	-
	1000	250	BN07712186	97,36	-	-
	1000	300	BN07713186	107,60	-	-
	1000	400	BN07714186	122,36	-	-

WT3 - Single-sided wooden top shelf - full depth

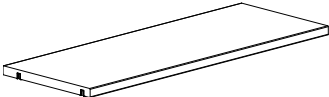
Particleboard. Incl. fittings (snapfix and screws).	Module mm	Shelf depth mm	Item no.	Melamine EUR	Painted EUR	Veneer EUR
	500	250 = 280	BN07752196	57,59	-	-
	500	300 = 330	BN07753196	64,51	-	-
	500	400 = 430	BN07754196	72,88	-	-
	750	250 = 280	BN07772196	86,72	-	-
	750	300 = 330	BN07773196	96,43	-	-
	750	400 = 430	BN07774196	109,19	-	-
	900	250 = 280	BN07792196	86,72	-	-
	900	300 = 330	BN07793196	96,43	-	-
	900	400 = 430	BN07794196	109,19	-	-
	1000	250 = 280	BN07712196	97,36	-	-
	1000	300 = 330	BN07713196	107,60	-	-
	1000	400 = 430	BN07714196	122,36	-	-

WT3 - Double-sided wooden top shelf

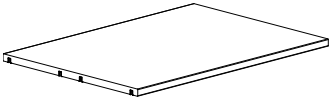
Particleboard. Incl. fittings (snapfix and screws).	Module mm	Shelf depth mm	Item no.	Melamine EUR	Painted EUR	Veneer EUR
	500	2 x 250 = 537	BN07752286	77,01	-	-
	500	2 x 300 = 637	BN07753286	118,37	-	-
	500	2 x 400 = 837	BN07754286	180,48	-	-
	750	2 x 250 = 537	BN07772286	115,71	-	-
	750	2 x 300 = 637	BN07773286	177,82	-	-
	750	2 x 400 = 837	BN07774286	270,92	-	-
	900	2 x 250 = 537	BN07792286	115,71	-	-
	900	2 x 300 = 637	BN07793286	177,82	-	-
	900	2 x 400 = 837	BN07794286	270,92	-	-
	1000	2 x 250 = 537	BN07712286	128,61	-	-
	1000	2 x 300 = 637	BN07713286	197,37	-	-
	1000	2 x 400 = 837	BN07714286	300,98	-	-

SHELVES

WO1 - WOODEN OVERLAYING TOP PLATE

Choose between a steel or wooden top shelf (placed in between the wooden panels) or a wooden overlaying top plate (placed on top of the panels).

WO1 - WOODEN OVERLAYING TOP PLATE

Details:

- Module 500/750/900/100 mm
- Depth 250/300/400 mm
- Melamine/painted/veneer
- Single-/double-sided
- Freestanding/outer/intermediate
- Max. weight 25 kg.
- Particle board

Use with:

- S1/S2/S3/S4 - steel shelves
- W1/W2/W3/W4 - wooden shelves
- WP3/4/7/8 - wooden panel
- WBP1/3 - wooden back panel

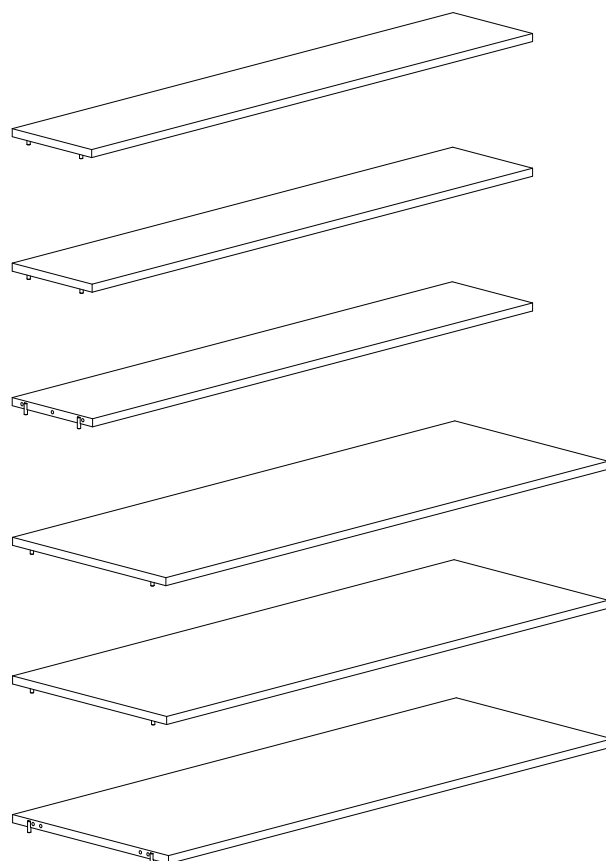

SHELVES

WO1 - WOODEN OVERLAYING TOP PLATE - SINGLE-SIDED

Painted and veneered shelves are FSC-certified.

WO1 - Single-sided wooden overlaying top plate - freestanding

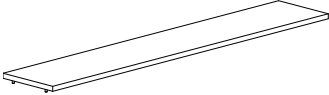
Particleboard. Incl. fittings.	Module mm	Shelf depth mm	No. of bays	Item no.	Melamine EUR	Painted EUR	Veneer EUR
	500	250	1	BN0303515.	69,29	81,40	114,11
	500	250	2	BN0303525.	124,62	146,70	205,49
	500	250	3	BN0303535.	187,00	219,98	308,03
	500	300	1	BN0305515.	76,74	90,44	126,62
	500	300	2	BN0305525.	138,45	163,06	227,83
	500	300	3	BN0305535.	207,75	244,45	341,94
	500	400	1	BN0307515.	84,85	99,48	139,52
	500	400	2	BN0307525.	152,29	179,02	250,57
	500	400	3	BN0307535.	228,36	268,66	376,12
	750	250	1	BN0303715.	103,87	122,23	171,04
	750	250	2	BN0303725.	186,87	219,85	307,63
	750	250	3	BN0303735.	280,23	329,71	461,64
	750	300	1	BN0305715.	115,44	135,93	190,19
	750	300	2	BN0305725.	207,48	244,19	341,94
	750	300	3	BN0305735.	311,49	366,42	513,11
	750	400	1	BN0307715.	127,02	149,36	209,08
	750	400	2	BN0307725.	228,36	268,66	375,99
	750	400	3	BN0307735.	342,48	403,12	564,45
900	250	1	BN0303915.	103,87	122,23	171,04	
900	250	2	BN0303925.	186,87	219,85	307,63	
900	300	1	BN0305915.	115,44	135,93	190,19	
900	300	2	BN0305925.	207,48	244,19	341,94	
900	400	1	BN0307915.	127,02	149,36	209,08	
900	400	2	BN0307925.	228,36	268,66	375,99	
1000	250	1	BN0303115.	115,44	135,93	190,19	
1000	250	2	BN0303125.	207,48	244,19	341,94	
1000	300	1	BN0305115.	128,35	150,96	211,20	
1000	300	2	BN0305125.	230,76	271,45	380,11	
1000	400	1	BN0307115.	140,98	165,85	232,48	
1000	400	2	BN0307125.	253,90	298,72	417,75	

SHELVES

WO1 - WOODEN OVERLAYING TOP PLATE - SINGLE-SIDED

Painted and veneered shelves are FSC-certified.

WO1 - Single-sided wooden overlaying top plate - outer

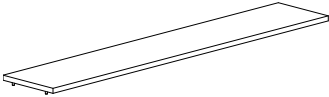
Particleboard. Incl. fittings.	Module mm	Shelf depth mm	No. of bays	Item no.	Melamine EUR	Painted EUR	Veneer EUR
	500	250	1	BN0303514.	69,29	81,40	114,11
	500	250	2	BN0303524.	124,62	146,70	205,49
	500	250	3	BN0303534.	187,00	219,98	308,03
	500	300	1	BN0305514.	76,74	90,44	126,62
	500	300	2	BN0305524.	138,45	163,06	227,83
	500	300	3	BN0305534.	207,75	244,45	341,94
	500	400	1	BN0307514.	84,85	99,48	139,52
	500	400	2	BN0307524.	152,29	179,02	250,57
	500	400	3	BN0307534.	228,36	268,66	376,12
	750	250	1	BN0303714.	103,87	122,23	171,04
	750	250	2	BN0303724.	186,87	219,85	307,63
	750	250	3	BN0303734.	280,23	329,71	461,64
	750	300	1	BN0305714.	115,44	135,93	190,19
	750	300	2	BN0305724.	207,48	244,19	341,94
	750	300	3	BN0305734.	311,49	366,42	513,11
	750	400	1	BN0307714.	127,02	149,36	209,08
	750	400	2	BN0307724.	228,36	268,66	375,99
	750	400	3	BN0307734.	342,48	403,12	564,45
900	250	1	BN0303914.	103,87	122,23	171,04	
900	250	2	BN0303924.	186,87	219,85	307,63	
900	300	1	BN0305914.	115,44	135,93	190,19	
900	300	2	BN0305924.	207,48	244,19	341,94	
900	400	1	BN0307914.	127,02	149,36	209,08	
900	400	2	BN0307924.	228,36	268,66	375,99	
1000	250	1	BN0303114.	115,44	135,93	190,19	
1000	250	2	BN0303124.	207,48	244,19	341,94	
1000	300	1	BN0305114.	128,35	150,96	211,20	
1000	300	2	BN0305124.	230,76	271,45	380,11	
1000	400	1	BN0307114.	140,98	165,85	232,48	
1000	400	2	BN0307124.	253,90	298,72	417,75	

SHELVES

WO1 - WOODEN OVERLAYING TOP PLATE - SINGLE-SIDED

Painted and veneered shelves are FSC-certified.

WO1 - Single-sided wooden overlaying top plate - intermediate

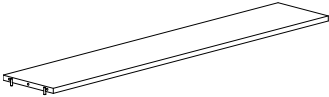
Particleboard. Incl. fittings.	Module mm	Shelf depth mm	No. of bays	Item no.	Melamine EUR	Painted EUR	Veneer EUR
	500	250	1	BN0303513.	69,29	81,40	114,11
	500	250	2	BN0303523.	124,62	146,70	205,49
	500	250	3	BN0303533.	187,00	219,98	308,03
	500	300	1	BN0305513.	76,74	90,44	126,62
	500	300	2	BN0305523.	138,45	163,06	227,83
	500	300	3	BN0305533.	207,75	244,45	341,94
	500	400	1	BN0307513.	84,85	99,48	139,52
	500	400	2	BN0307523.	152,29	179,02	250,57
	500	400	3	BN0307533.	228,36	268,66	376,12
	750	250	1	BN0303713.	103,87	122,23	171,04
	750	250	2	BN0303723.	186,87	219,85	307,63
	750	250	3	BN0303733.	280,23	329,71	461,64
	750	300	1	BN0305713.	115,44	135,93	190,19
	750	300	2	BN0305723.	207,48	244,19	341,94
	750	300	3	BN0305733.	311,49	366,42	513,11
	750	400	1	BN0307713.	127,02	149,36	209,08
	750	400	2	BN0307723.	228,36	268,66	375,99
	750	400	3	BN0307733.	342,48	403,12	564,45
900	250	1	BN0303913.	103,87	122,23	171,04	
900	250	2	BN0303923.	186,87	219,85	307,63	
900	300	1	BN0305913.	115,44	135,93	190,19	
900	300	2	BN0305923.	207,48	244,19	341,94	
900	400	1	BN0307913.	127,02	149,36	209,08	
900	400	2	BN0307923.	228,36	268,66	375,99	
1000	250	1	BN0303113.	115,44	135,93	190,19	
1000	250	2	BN0303123.	207,48	244,19	341,94	
1000	300	1	BN0305113.	128,35	150,96	211,20	
1000	300	2	BN0305123.	230,76	271,45	380,11	
1000	400	1	BN0307113.	140,98	165,85	232,48	
1000	400	2	BN0307123.	253,90	298,72	417,75	

SHELVES

WO1 - WOODEN OVERLAYING TOP PLATE - DOUBLE-SIDED

Painted and veneered shelves are FSC-certified.

WO1 - Double-sided wooden overlaying top plate - freestanding

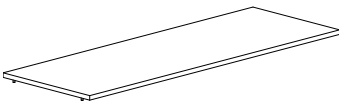
Particleboard. Incl. fittings.	Module mm	Shelf depth mm	No. of bays	Item no.	Melamine EUR	Painted EUR	Veneer EUR
	500	250	1	BN0304515.	106,67	125,42	175,29
	500	250	2	BN0304525.	191,65	225,44	315,48
	500	250	3	BN0304535.	287,68	338,35	473,88
	500	300	1	BN0306515.	118,24	139,25	194,85
	500	300	2	BN0306525.	212,80	250,44	350,59
	500	300	3	BN0306535.	319,47	375,86	526,28
	500	400	1	BN0308515.	130,21	153,08	214,40
	500	400	2	BN0308525.	234,08	275,58	385,57
	500	400	3	BN0308535.	351,39	413,50	578,82
	750	250	1	BN0304715.	159,87	188,33	263,21
	750	250	2	BN0304725.	287,68	338,35	473,61
	750	250	3	BN0304735.	431,32	507,40	710,49
	750	300	1	BN0306715.	177,82	208,94	292,47
	750	300	2	BN0306725.	319,33	375,73	526,02
	750	300	3	BN0306735.	479,47	563,92	789,62
	750	400	1	BN0308715.	195,38	229,82	321,73
	750	400	2	BN0308725.	351,25	413,36	578,68
	750	400	3	BN0308735.	527,35	620,45	868,22
900	250	1	BN0304915.	159,87	188,33	263,21	
900	250	2	BN0304925.	287,68	338,35	473,61	
900	300	1	BN0306915.	177,82	208,94	292,47	
900	300	2	BN0306925.	319,33	375,73	526,02	
900	400	1	BN0308915.	195,38	229,82	321,73	
900	400	2	BN0308925.	351,25	413,36	578,68	
1000	250	1	BN0304115.	177,82	208,94	292,47	
1000	250	2	BN0304125.	319,33	375,73	526,02	
1000	300	1	BN0306115.	197,37	232,22	324,79	
1000	300	2	BN0306125.	354,84	417,49	584,40	
1000	400	1	BN0308115.	216,92	255,23	357,24	
1000	400	2	BN0308125.	390,22	459,12	643,06	

SHELVES

WO1 - WOODEN OVERLAYING TOP PLATE - DOUBLE-SIDED

Painted and veneered shelves are FSC-certified.

WO1 - Double-sided wooden overlaying top plate - outer

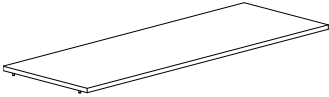
Particleboard. Incl. fittings.	Module mm	Shelf depth mm	No. of bays	Item no.	Melamine EUR	Painted EUR	Veneer EUR
	500	250	1	BN0304514.	106,67	125,42	175,29
	500	250	2	BN0304524.	191,65	225,44	315,48
	500	250	3	BN0304534.	287,68	338,35	473,88
	500	300	1	BN0306514.	118,24	139,25	194,85
	500	300	2	BN0306524.	212,80	250,44	350,59
	500	300	3	BN0306534.	319,47	375,86	526,28
	500	400	1	BN0308514.	130,21	153,08	214,40
	500	400	2	BN0308524.	234,08	275,58	385,57
	500	400	3	BN0308534.	351,39	413,50	578,82
	750	250	1	BN0304714.	159,87	188,33	263,21
	750	250	2	BN0304724.	287,68	338,35	473,61
	750	250	3	BN0304734.	431,32	507,40	710,49
	750	300	1	BN0306714.	177,82	208,94	292,47
	750	300	2	BN0306724.	319,33	375,73	526,02
	750	300	3	BN0306734.	479,47	563,92	789,62
	750	400	1	BN0308714.	195,38	229,82	321,73
	750	400	2	BN0308724.	351,25	413,36	578,68
	750	400	3	BN0308734.	527,35	620,45	868,22
900	250	1	BN0304914.	159,87	188,33	263,21	
900	250	2	BN0304924.	287,68	338,35	473,61	
900	300	1	BN0306914.	177,82	208,94	292,47	
900	300	2	BN0306924.	319,33	375,73	526,02	
900	400	1	BN0308914.	195,38	229,82	321,73	
900	400	2	BN0308924.	351,25	413,36	578,68	
1000	250	1	BN0304114.	177,82	208,94	292,47	
1000	250	2	BN0304124.	319,33	375,73	526,02	
1000	300	1	BN0306114.	197,37	232,22	324,79	
1000	300	2	BN0306124.	354,84	417,49	584,40	
1000	400	1	BN0308114.	216,92	255,23	357,24	
1000	400	2	BN0308124.	390,22	459,12	643,06	

SHELVES

WO1 - WOODEN OVERLAYING TOP PLATE - DOUBLE-SIDED

Painted and veneered shelves are FSC-certified.

WO1 - Double-sided wooden overlaying top plate - intermediate

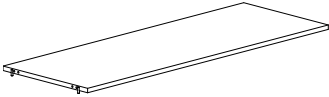
Particleboard. Incl. fittings.	Module mm	Shelf depth mm	No. of bays	Item no.	Melamine EUR	Painted EUR	Veneer EUR
	500	250	1	BN0304513.	106,67	125,42	175,29
	500	250	2	BN0304523.	191,65	225,44	315,48
	500	250	3	BN0304533.	287,68	338,35	473,88
	500	300	1	BN0306513.	118,24	139,25	194,85
	500	300	2	BN0306523.	212,80	250,44	350,59
	500	300	3	BN0306533.	319,47	375,86	526,28
	500	400	1	BN0308513.	130,21	153,08	214,40
	500	400	2	BN0308523.	234,08	275,58	385,57
	500	400	3	BN0308533.	351,39	413,50	578,82
	750	250	1	BN0304713.	159,87	188,33	263,21
	750	250	2	BN0304723.	287,68	338,35	473,61
	750	250	3	BN0304733.	431,32	507,40	710,49
	750	300	1	BN0306713.	177,82	208,94	292,47
	750	300	2	BN0306723.	319,33	375,73	526,02
	750	300	3	BN0306733.	479,47	563,92	789,62
	750	400	1	BN0308713.	195,38	229,82	321,73
	750	400	2	BN0308723.	351,25	413,36	578,68
	750	400	3	BN0308733.	527,35	620,45	868,22
900	250	1	BN0304913.	159,87	188,33	263,21	
900	250	2	BN0304923.	287,68	338,35	473,61	
900	300	1	BN0306913.	177,82	208,94	292,47	
900	300	2	BN0306923.	319,33	375,73	526,02	
900	400	1	BN0308913.	195,38	229,82	321,73	
900	400	2	BN0308923.	351,25	413,36	578,68	
1000	250	1	BN0304113.	177,82	208,94	292,47	
1000	250	2	BN0304123.	319,33	375,73	526,02	
1000	300	1	BN0306113.	197,37	232,22	324,79	
1000	300	2	BN0306123.	354,84	417,49	584,40	
1000	400	1	BN0308113.	216,92	255,23	357,24	
1000	400	2	BN0308123.	390,22	459,12	643,06	

SHELVES

DISPLAY & STORAGE

Steel shelf for pocketbooks, CD's and DVD's

Incl. fittings.
H200 x D225 mm

Module
mm

Item no.

Price
EUR

900

BN520

128,35



Steel shelf for CD's

Incl. fittings.
H175 x D200 mm

Module
mm

Item no.

Price
EUR

750
900

B7851737
B7851739

197,90
197,90

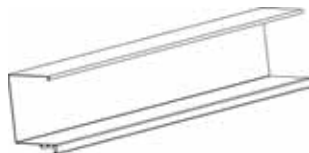

Steel shelf for DVD's

Incl. fittings.
H273 x D300 mm.

Module
mm

Item no.

Price
EUR

750
900

B7851707
B7851709

197,90
197,90



SHELVES

DISPLAY & STORAGE

Steel shelf - 4 compartments (W22.4 cm) with 3 steel dividers

Incl. fittings. W900 x H200 x Dxx mm.
Capacity: 75 picture books

Depth
mm

Item no.

Price
EUR

250
300

BN5162
BN5163

161,86
179,15

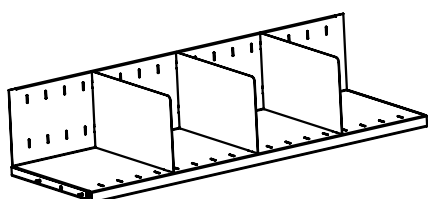

Sloping bottom shelf

Incl. fittings

Module
mm

Depth of
shelving - mm

Item no.

Price
EUR

500 250
500 300

BN53052
BN53053

63,97
63,97

750 250
750 300

BN53072
BN53073

63,97
63,97

900 250
900 300

BN53092
BN53093

63,97
63,97

1000 250
1000 300

BN53012
BN53013

63,97
63,97

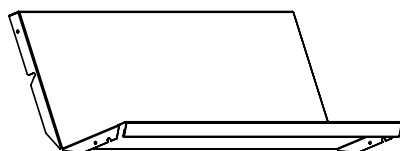

FUNCTIONS

STEEL BROWSERS

Single browser - without/with pull-out

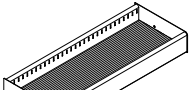
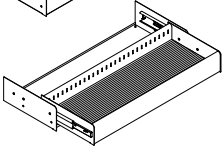
Module 750 mm. Incl. fittings and rubber mat. Excl. tubes	Panel depth mm	Browser height mm	Browser depth mm	No. of dividers	Item no. Fixed	Price EUR	Item no. Pull-out	Price EUR
 	300	100	300 ^{*1}	0	BN55073100	255,63	BN55273500	466,30
	300	100	300	1	BN55073101	270,79	BN55273501	481,33
	300	100	300	2	BN55073102	284,35	BN55273502	495,82
	300	100	300	4	BN55073104	314,55	BN55273504	524,95

Single browser - without/with pull-out

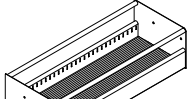
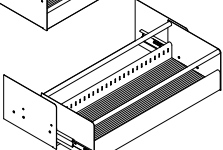
Module 750 mm. Incl. fittings, rubber mat and tubes.	Panel depth mm	Browser height mm	Browser depth mm	No. of dividers	Item no. Fixed	Price EUR	Item no. Pull-out	Price EUR
 	300	200	300 ^{*2}	0	BN55073200	336,76	BN55273600	547,03
	300	200	300	1	BN55073201	353,78	BN55273601	564,72
	300	200	300	2	BN55073202	370,27	BN55273602	582,01
	300	200	300	4	BN55073204	405,12	BN55273604	616,32

Single browser - without/with pull-out

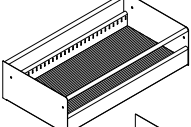
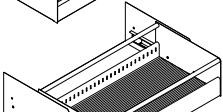
Module 750 mm. Incl. fittings, rubber mat and tubes.	Panel depth mm	Browser height mm	Browser depth mm	No. of dividers	Item no. Fixed	Price EUR	Item no. Pull-out	Price EUR
 	300	200	400 ^{*3}	0	BN55073300	347,00		
	300	200	400	1	BN55073301	364,02		
	300	200	400	2	BN55073302	381,31		
	300	200	400	4	BN55073304	415,49		
	400	200	400	0	BN55074300	347,00	BN55274700	557,94
	400	200	400	1	BN55074301	364,02	BN55274701	574,96
	400	200	400	2	BN55074302	381,31	BN55274702	592,52
	400	200	400	4	BN55074304	415,49	BN55274704	627,10

Double browser - without/with pull-out

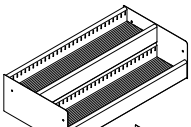
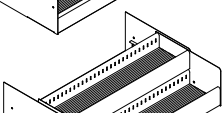
Module 750 mm. Incl. fittings and rubber mat. Excl. tubes	Panel depth mm	Browser height mm	Browser depth mm	No. of dividers	Item no. Fixed	Price EUR	Item no. Pull-out	Price EUR
 	300	200	400 ^{*4}	0	BN55073400	458,45		
	300	200	400	2	BN55073402	482,92		
	300	200	400	4	BN55073404	506,33		
	300	200	400	8	BN55073408	554,74		
	400	200	400	0	BN55074400	458,45	BN55274800	669,52
	400	200	400	2	BN55074402	482,92	BN55274802	693,46
	400	200	400	4	BN55074404	506,33	BN55274804	717,80
	400	200	400	8	BN55074408	554,74	BN55274808	765,42

FUNCTIONS

STEEL BROWSERS

Single browser - without/with pull-out

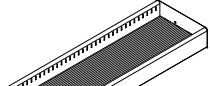
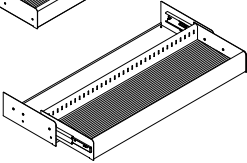
Module 900 mm. Incl. fittings and rubber mat. Excl. tubes	Panel depth mm	Browser height mm	Browser depth mm	No. of dividers	Item no. Fixed	Price EUR	Item no. Pull-out	Price EUR
 	300	100	300 ^{*1}	0	BN55093100	255,63	BN55293500	466,30
	300	100	300	2	BN55093102	284,35	BN55293502	495,82
	300	100	300	4	BN55093104	314,55	BN55293504	524,95
	300	1000	300	5	BN55093105	329,18	BN55293505	540,11

Single browser - without/with pull-out

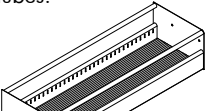
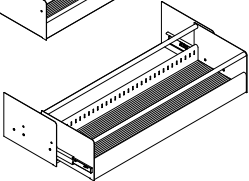
Module 900 mm. Incl. fittings, rubber mat and tubes.	Panel depth mm	Browser height mm	Browser depth mm	No. of dividers	Item no. Fixed	Price EUR	Item no. Pull-out	Price EUR
 	300	200	300 ^{*2}	0	BN55093200	336,76	BN55293600	547,03
	300	200	300	2	BN55093202	370,27	BN55293602	582,01
	300	200	300	4	BN55093204	405,12	BN55293604	616,32
	300	200	300	5	BN55093205	422,67	BN55293605	633,61

Single browser - without/with pull-out

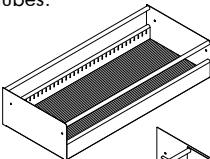
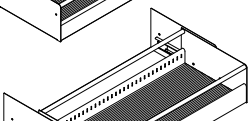
Module 900 mm. Incl. fittings, rubber mat and tubes.	Panel depth mm	Browser height mm	Browser depth mm	No. of dividers	Item no. Fixed	Price EUR	Item no. Pull-out	Price EUR
 	300	200	400 ^{*3}	0	BN55093300	347,00		
	300	200	400	2	BN55093302	381,31		
	300	200	400	4	BN55093304	415,49		
	300	200	400	5	BN55093305	432,78		
	400	200	400	0	BN55094300	347,00	BN55294700	557,94
	400	200	400	2	BN55094302	381,31	BN55294702	592,52
	400	200	400	4	BN55094304	415,49	BN55294704	627,10
	400	200	400	5	BN55094305	432,78	BN55294705	643,85

Double browser - without/with pull-out

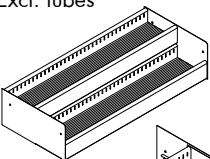
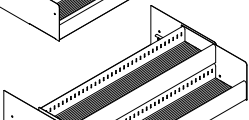
Module 900 mm. Incl. fittings and rubber mat. Excl. tubes	Panel depth mm	Browser height mm	Browser depth mm	No. of dividers	Item no. Fixed	Price EUR	Item no. Pull-out	Price EUR
 	300	200	400 ^{*4}	0	BN55093400	458,45		
	300	200	400	4	BN55093404	506,33		
	300	200	400	8	BN55093408	554,74		
	300	200	400	10	BN55093410	578,15		
	400	200	400	0	BN55094400	458,45	BN55294800	669,52
	400	200	400	4	BN55094404	506,33	BN55294804	717,80
	400	200	400	8	BN55094408	554,74	BN55294808	765,42
	400	200	400	10	BN55094410	578,15	BN55294810	789,22

FUNCTIONS

STEEL BROWSERS

Single AV steel browser - for shelf

H100 mm. Lacquered steel browser and dividers with black flocked steel rods. Rubber mat and 2-5 moveable dividers incl. To be fastened onto existing 250 or 300 mm deep steel or wooden shelf without backedge.

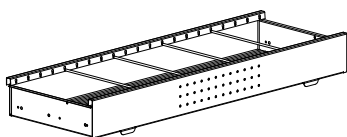

Module	Shelf depth mm	No. of dividers	Item no.	Price EUR
500	250	2	B405085552102	194,45
500	300	2	B405085553102	203,09
500	400	2	B405085554102	213,07
750	250	3	B405085572103	224,77
750	300	3	B405085573102	228,23
750	400	3	B405085574103	245,65
900	250	4	B405085592104	232,75
900	300	4	B405085593104	243,39
900	400	4	B405085594104	255,36
1000	250	5	B405085512105	237,94
1000	300	5	B405085513105	248,98
1000	400	5	B405085514105	261,35

Single AV steel browser - fixed

H100 mm. Lacquered steel browser and dividers with black flocked steel rods. Rubber mat and 2-5 moveable dividers incl.

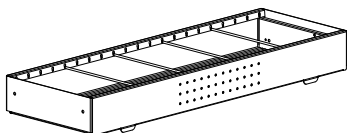

Module	Shelf depth mm	No. of dividers	Item no.	Price EUR
500	250	2	B405085552302	248,71
500	300	2	B405085553302	270,39
500	400	2	B405085554302	283,69
750	250	3	B405085572303	278,77
750	300	3	B405085573303	300,85
750	400	3	B405085574303	316,01
900	250	4	B405085592304	287,15
900	300	4	B405085593304	310,16
900	400	4	B405085594304	325,72
1000	250	5	B405085512305	292,33
1000	300	5	B405085513305	315,74
1000	400	5	B405085514305	331,44

FUNCTIONS

STEEL BROWSERS

For safety reasons only load the the browsers with pull-out function with a maximum of 15 kg. Only install a maximum of 3 pull-out browsers on single-sided shelving and 1 pull-out browsers on each side of a double-sided shelving. Shelving with castors should not have pull-out browsers installed. The lowest browser must be at least 50 cm above the floor to prevent being used as a step.

Single AV steel browser - with pull-out

H100 mm. Lacquered steel browser and dividers with black flocked steel rods. Rubber mat and 2-5 moveable dividers incl. With handle for pull-out function on telescopic rails.

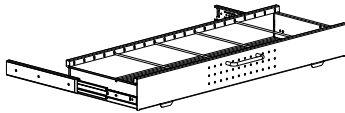

Module	Shelf depth mm	No. of dividers	Item no.	Price EUR
500	250	2	B405085552502	333,96
500	300	2	B405085553502	355,38
500	400	2	B405085554502	373,07
750	250	3	B405085572503	364,15
750	300	3	B405085573503	386,10
750	400	3	B405085574503	405,65
900	250	4	B405085592504	372,40
900	300	4	B405085593504	395,41
900	400	4	B405085594504	415,23
1000	250	5	B405085512505	377,45
1000	300	5	B405085513505	401,00
1000	400	5	B405085514505	421,08

Single AV steel browser - pull-out and soft closing

H100 mm. Lacquered steel browser and dividers with black flocked steel rods. Rubber mat and 2-5 moveable dividers incl. With handle for pull-out function on telescopic rails.

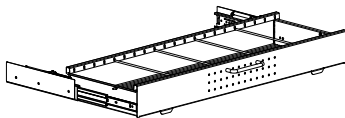

Module	Shelf depth mm	No. of dividers	Item no.	Price EUR
500	250	2	B405085552702	366,15
500	300	2	B405085553702	387,56
500	400	2	B405085554702	406,98
750	250	3	B405085572703	396,61
750	300	3	B405085573703	418,55
750	400	3	B405085574703	439,57
900	250	4	B405085592704	404,45
900	300	4	B405085593704	427,60
900	400	4	B405085594704	449,01
1000	250	5	B405085512705	409,51
1000	300	5	B405085513705	432,92
1000	400	5	B405085514705	454,73

FUNCTIONS

STEEL BROWSERS

Divider for single-/double browser

Additional steel divider.
Chromed steel.

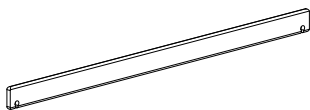

Type	Height mm	Shelf depth mm	Item no.	Price EUR
Single	100	300	B4011603	15,16
Single	200	300	B4011603	15,16
Single	200	400	B4011604	17,56
Double	200	400	B4011601	12,24

Divider for AV steel browser

Additional lacquered steel divider with
flocked steel rod.

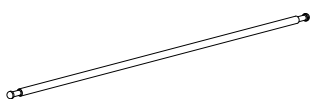

Shelf depth mm	Item no.	Price EUR
250	B4010702	33,25
300	B4010703	33,25
400	B4010704	33,25

FUNCTIONS

STEEL BROWSERS

Capacity examples for 750 mm fixed single/double browser (see page 168)

	Type	Module	H x D mm	CD cases	DVD cases	CD pockets	Picture books	Comic picture books
				5 rows	5 rows	5 rows	3 rows	2 rows
*1	Single	750	100 x 300	100	75	325	-	-
*2	Single	750	200 x 300	100	75	325	90	40
*3	Single	750	200 x 400	150	105	325	120	50
				2 x 5 rows	2 x 5 rows	2 x 5 rows	3 rows	2 rows
*4	Double	750	200 x 400	130	95	400	-	-

Capacity examples for 750 mm single/double browser with pull-out (see page 168)

	Type	Module	H x D mm	CD cases	DVD cases	CD pockets	Picture books	Comic picture books
				5 rows	5 rows	5 rows	3 rows	2 rows
*1	Single	750	100 x 300	80	60	260	-	-
*2	Single	750	200 x 300	80	60	260	90	40
*3	Single	750	200 x 400	120	84	340	120	50
				2 x 5 rows	2 x 5 rows	2 x 5 rows	3 rows	2 rows
*4	Double	750	200 x 400	104	76	320	-	-

Capacity examples for 900 mm fixed single/double browser (see page 169)

	Type	Module	H x D mm	CD cases	DVD cases	CD pockets	Picture books	Comic picture books
				6 rows	6 rows	6 rows	4 rows	3 rows
*1	Single	900	100 x 300	120	90	390	-	-
*2	Single	900	200 x 300	120	90	390	120	60
*3	Single	900	200 x 400	180	126	510	180	75
				2 x 6 rows	2 x 6 rows	2 x 6 rows	4 rows	3 rows
*4	Double	900	200 x 400	156	114	480	-	-

Capacity examples for 900 mm single/double browser with pull-out (see page 169)

	Type	Module	H x D mm	CD cases	DVD cases	CD pockets	Picture books	Comic picture books
				6 rows	6 rows	6 rows	4 rows	3 rows
*1	Single	900	100 x 300	100	75	325	-	-
*2	Single	900	200 x 300	100	75	325	120	60
*3	Single	900	200 x 400	150	105	425	160	75
				2 x 6 rows	2 x 6 rows	2 x 6 rows	4 rows	3 rows
*4	Double	900	200 x 400	130	95	400	-	-

Capacity examples for 500/750/900/1000 mm AV steel browser (see page 170-171)

Module	Depth mm	CD/DVD cases		Module	Depth mm	CD/DVD cases
500	250	60		500	300	72
750	250	80		750	300	96
900	250	100		900	300	120
1000	250	120		1000	300	144

FUNCTIONS

WOODEN BROWSER

Wooden picture book browser with 4 adjustable compartments (FSC)

W900 x H220/120 x D300 mm.
Incl. 3 dividers and fittings.

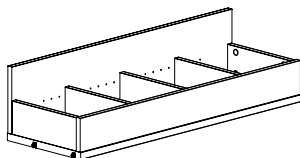

Finish

Item no.

Price
EUR

Painted

BN5107

446,35

Veneer

BN5102

624,57

Wooden CD/DVD browser with 5 adjustable compartments (FSC)

W900 x H170/130 x D300 mm. Incl. 4 dividers and pull out frame with 100% expansion.

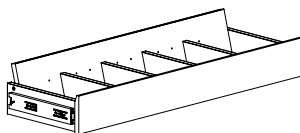

Finish

Item no.

Price
EUR

Painted

B7840045

898,81

Veneer

B7840041

1.257,65

FUNCTIONS

DISPLAY & STORAGE

Wooden newspaper cassette with 8 acrylic compartments (FSC)

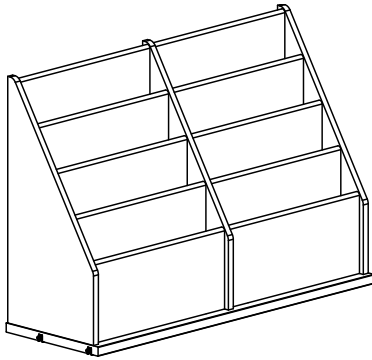

Module mm	Depth mm	Finish	Item no.	Price EUR
900	300	Melamine	BN5286	999,23
900	300	Painted	BN5287	1.175,59
900	300	Veneer	BN5282	1.645,74

FUNCTIONS

DISPLAY & STORAGE

If the steel magazine display is placed at the bottom of the shelving and equipped with either plinth or castors, we recommend ordering a D400 mm shelf as bottom shelf, as the shelf inside the magazine display is only D300 mm.

Steel magazine display - with 1 tip up sloping shelf

Incl. fittings. H400 mm.
For storage of horizontally piled magazines or vertical binders (up to 320 mm in height).

Module mm	Depth mm
900	300
900	400

Item no.	Price EUR
BN5023	483,59
BN5024	483,59

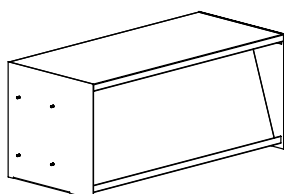

Steel magazine display - with 1 tip up sloping shelf and moveable dividers

Incl. fittings. H400 mm. For separate storage of horizontally piled magazines or vertical binders (up to 320 mm in height). Dividers can be moved 50 mm either way.

Module mm	Depth mm
900	300
900	400

Item no.	Price EUR
BN5043	567,91
BN5044	567,91

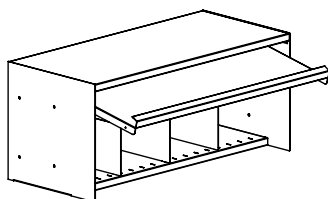

Steel magazine display - with 3 tip up sloping shelves

Incl. fittings. H400 mm. For separate storage of either magazines piled horizontally or vertical binders (up to 320 mm in height).

Module mm	Depth mm
900	300
900	400

Item no.	Price EUR
BN5063	599,83
BN5064	599,83

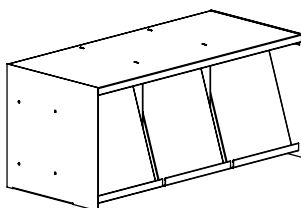

FUNCTIONS

DISPLAY & STORAGE

Steel magazine box - Unibox

H320 x D260 x W320 mm. Box and flap lacquered steel. With transparent antireflex foil. Recommended for use on D250 mm steel shelf with/without backedge and wooden shelf without backedge. Can be used on D300 mm shelves. With space for storage of magazines piled horizontally 140 mm.

Design	Back wall	Item no.	Price EUR
Plain	Yes	B405502001	221,98
Plain	No	B405502000	202,43
With holes	Yes	B405502051	231,82
With holes	No	B405502050	212,53
With slots	Yes	B405502101	243,66
With slots	No	B405502100	224,24

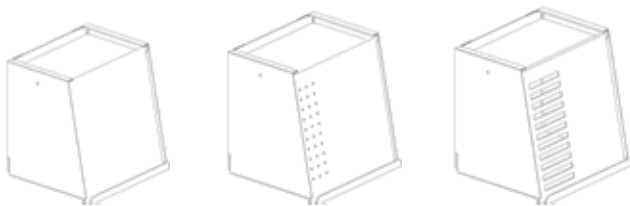

Steel magazine box

H320 x D260 x W238 mm. Box and flap lacquered steel. Recommended for use on D250 mm steel shelf with/without backedge and wooden shelf without backedge. Can be used on D300 mm shelves. Upright storage of magazines. With space for storage of magazines piled vertically 140 mm.

Item no.	Price EUR
B405504	248,84

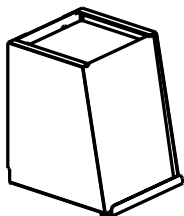

Steel magazine flap

H340 mm (without shelf). Lacquered steel. Min. height between shelves must be 327 mm. To be screwed into panels. Effective lever mechanism keeps the open flap up. Easily retrofitted for single- and double-sided shelves. Recommended to use with back panels. With space for storage of magazines piled horizontally 160 mm.

Module mm	Depth mm	Item no.	Price EUR
500	250	BN50025	190,99
500	300	BN50035	195,91
500	400	BN50045	209,21
750	250	BN50027	214,40
750	300	BN50037	218,52
750	400	BN50047	232,75
900	250	BN50029	225,83
900	300	BN50039	229,96
900	400	BN50049	241,66
1000	250	BN50021	237,27
1000	300	BN50031	241,13
1000	400	BN50041	253,10

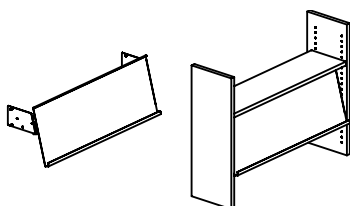

FUNCTIONS

DISPLAY & STORAGE - FOR SHELVES

Steel magazine display

H300 mm. With slanted back and additional side stop. A double front edge keeps this collector flush with the front edge of the shelf. With slip stop to prevent the display from slipping on steel shelves.

Size	Width mm
DIN A4	220
DIN A3	440

Item no.	Price EUR
B4055064	46,15
B4055063	79,40

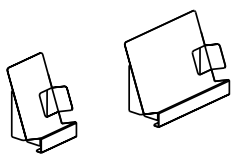

Steel magazine divider

H300 x W95 x D240 mm. Single, slanted element connectable side by side via plug-in connections. For bay W700 mm, use 6 dividers. For bay W900 mm, use 8 dividers. For bay W1000 mm, use 9 dividers.

Size
DIN A4

Item no.	Price EUR
B405508	40,30

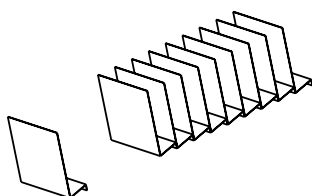

Steel U-storage

H250 x W145 x D220 mm.
Multi-functional storage use.

Item no.	Price EUR
B405510	55,20

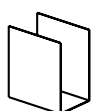

FUNCTIONS

DISPLAY & STORAGE - FOR SHELVES

Plastic periodical collector

H325 x W80 x D230 mm. Light grey plastic. Multi-functional storage use. With front-edge for easy guidance along shelf.

Item no.

Price

EUR

B4056016

21,01



Steel slanted CD tray

H120 x W150 x D220 mm. With anti-slipping feet. Rubber mat to be ordered separately.

Approx. capacity

Item no.

Price

EUR

20 CD's

B405536

73,02

Rubber mat

B405538

9,44

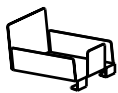

FUNCTIONS

BOOK SUPPORTS

Backedge book support - for S1

Nickel plated steel, Ø6 mm,
with a nylon glider.

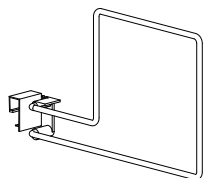

Height mm	Shelf depth mm	Type	Item no.	Price EUR
163	250	For books on left side of book support	B4011221	16,89
163	300	For books on left side of book support	B4011222	18,22
243	250/300	For books on left side of book support	B4011223	23,67
163	250	For books on right side of book support	B4011224	16,89
163	300	For books on right side of book support	B4011225	18,22

Hanging book support - for S2 and W2/4 with rail

Available in chrome steel or
standard steel colours.

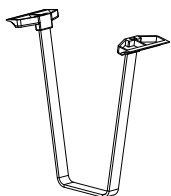

Height mm	Item no.	Price EUR
200	B4011242	9,04
250	B4011245	9,71

Rail for fixing hanging book support under W2 & W4

Fix underneath wooden shelf.
For book support B40112x.
Incl. fittings

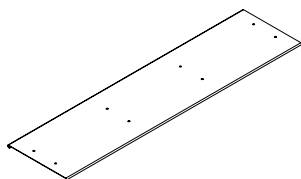

Module	Item no.	Price EUR
750	B4022007	32,45
900	B4022009	32,45

Hanging book support - for S3, S4 & ST3

Chromed round steel with
unbreakable plastic sliders.
Easy adjustable.

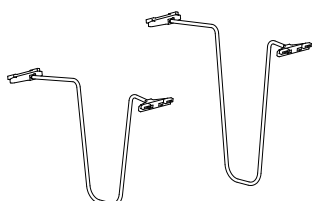

Height mm	Shelf depth mm	Item no.	Price EUR
220	250	B40553032	11,57
220	300	B40553033	12,24
280	250	B40553062	12,90
280	300	B40553063	13,83

FUNCTIONS

BOOK SUPPORTS

Divider for hanging book support

H250 x D240 mm. White plastic. For sliding onto hanging book support B405530. The divider rests upon the shelf. Is ideal for loose-leaf material, brochures, music books etc.

Item no.	Price EUR
B40553152	35,11



Steel angled book support

W150 x H150 x D150 mm.

Item no.	Price EUR
B401120	10,37

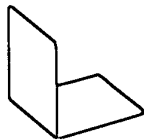

Steel angled book support

W120 x D150 mm.

Height
mm

175
240

Item no.	Price EUR
B4055321	11,44
B4055324	12,64

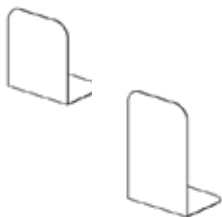

Steel angled book support - with shelf attachment

W150 x H200 x D150 mm.
Attaches onto front of shelf.
With or without letter tag.

Height
mm

200
200

200
200

Books left/right of
book support

Right
Left

Right
Left

With/without
letter tag

Without
Without

With
With

Item no.	Price EUR
B40553490	17,02
B40553480	17,02
B40553491	20,75
B40553481	20,75

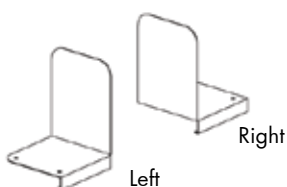

FUNCTIONS

SIGNAGE FOR FRONT OF STEEL AND WOODEN SHELVES

Plastic clip-on label holder - for S1/ST1 with 25 mm frontedge

H25 mm. Incl. white label. Can glide along shelf.

Width
mm

Item no.

Price
EUR

220

B401135

9,84

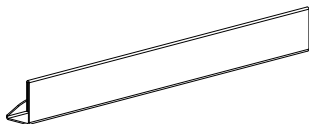

Plastic clip-on label holder - for S2/ST2

H25 mm. Incl. white label. Can glide along shelf.

Width
mm

Item no.

Price
EUR

213

E3381

-

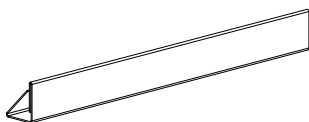

Plastic clip-on label holder - for S3/S4/W3/W4/WB3/WB4

H21 mm. Transparent, antireflective plastic. Incl. white label. Clips into groove underneath steel or wooden shelf. Can glide along shelf.

Width-
mm

Item no.

Price
EUR

105

Plastic clip-on label holder

B4017102

4,92

210

Plastic clip-on label holder

B4017106

5,45

104

White sheet w. 13 labels (spare part)

B4017111

0,93

209

White sheet w. 13 labels (spare part)

B4017116

0,93

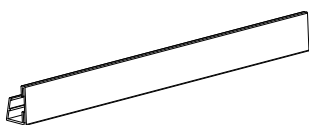

Plastic clip-on label holder - for ST3 & S4

H50 mm. Transparent, antireflective plastic. Incl. white label. Clips into groove underneath steel or wooden shelf. Can glide along shelf.

Module
mm

Item no.

Price
EUR

500

Plastic clip-on label holder

B40114455

33,38

750

Plastic clip-on label holder

B40114457

33,38

900

Plastic clip-on label holder

B40114459

33,38

1000

Plastic clip-on label holder

B40114451

33,38

500

Label (spare part)

B40114555

1,86

750

Label (spare part)

B40114557

1,86

900

Label (spare part)

B40114559

1,86

1000

Label (spare part)

B40114551

1,86

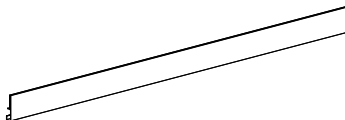

FUNCTIONS

SIGNAGE FOR FRONT OF STEEL AND WOODEN SHELVES

Self-adhesive plastic label holder - for S1/S2/S3/S4/ST1/ST2/ST3

H20 mm. Transparent, antireflective plastic. Incl. white label.	Width mm		Item no.	Price EUR
	147		B4017124	1,46
	200		B4017125	2,13

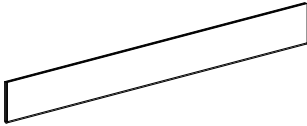

Magnetic plastic label holder - for S1/S2/S3/S4/ST2/ST3

H20 mm. Transparent, antireflective plastic. Incl. white label. Attach to steel shelves with smooth edge.	Width mm		Item no.	Price EUR
	210	Self-adhesive plastic label holder	B4017147	11,57
	209	White sheet w. 13 labels (spare part)	B4017116	0,93

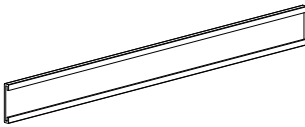

Magnetic shelf label - for ST1 with 47 mm frontedge

H40 mm. Black. Attach to steel shelves with smooth edge.	Width mm		Item no.	Price EUR
	300		B4000020300	11,31

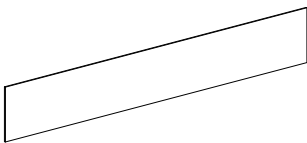

Steel label holder

H26 x W150 x D150 mm. Steel with transparent, antireflective plastic. Incl. white label. Universal use, simply place on shelf where needed.		Item no.	Price EUR
		B401801	11,57

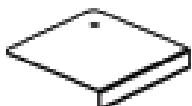

FUNCTIONS

SIGNAGE FOR END PANEL

End panel signage for wooden end panel - flat

Fastened to the end panel with screws. The sign has an acrylic film for insertion of text slide.

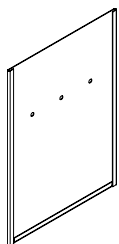

Format	Item no.	Price EUR
A4 vertical/upright format	B40110377	36,71
A3 vertical/upright format	B40110378	48,94
A3 horizontal format	B40110379	48,94



CASTORS

CASTOR FRAME & CASTOR PLATE



CASTORS

CASTOR FRAME & CASTORS

We recommend having a maximum of 3 adjoining bays mounted on castors.

Castor frame set with visible castors

A set of 2 frames and 4 Ø75 mm castors. To be used with double-sided panels WP1, WP2, WP3, WP4 and back panels WPB1/WBP2. Max. height 1520 mm. Order at least one castor frame with brakes.

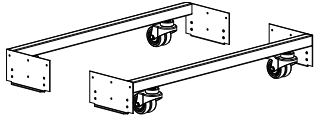

Module mm	x castors with brake	Item no.	Price EUR
500	0	BN06050	290,74
500	2	BN06051	308,43
750	0	BN06070	391,02
750	2	BN06071	408,58
900	0	BN06090	391,02
900	2	BN06091	408,58
1000	0	BN06010	424,54
1000	2	BN06011	442,09

Castors for visible castor frame set

Spare part. H112 mm, Ø75 mm. Max 90 kg. per castor.

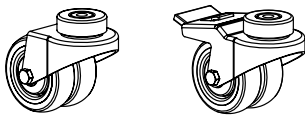

Type	Item no.	Price EUR
Without brake	B7860100	78,20
With brake	B7860101	94,70

Castor frame set with hidden castors and steel plinth

A set of 2 frames, 4 x Ø35 mm castors without brakes and 2 steel plinths. To be used with double-sided panels WP1, WP2, WP3, WP4 and back panels WPB1/WBP2. Max. height 1520 mm.

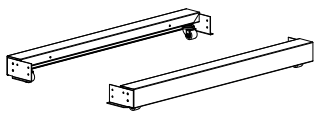

Module mm	Item no.	Price EUR
500	BN0615	461,24
750	BN0617	461,24
900	BN0619	461,24
1000	BN0611	495,29

Castors for hidden castor frame set

H50 mm, Ø35 mm. Spare part. Max. 100 kg per castor.

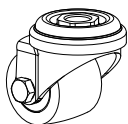

Type	Item no.	Price EUR
Without brake	B301017	57,46

CASTORS

CASTOR PLATES

Painted and veneered castor plates are FSC-certified.

Double-sided wooden castor plate

With 4/6/8 Ø75 mm castors, 2 of which are with brakes. To be used with double-sided panels for castor plate WP5/WP6/WP7/WP8 and WPB3/WBP4. Max. height 1520 mm.

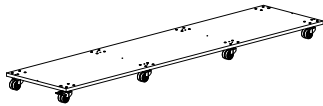

Module mm	Depth mm	No of bays	Item no.	Melamine EUR	Painted EUR	Veneer EUR
500	250	1	BN050451.	173,96	204,55	286,48
500	250	2	BN050452.	260,68	306,70	429,59
500	250	3	BN050453.	391,15	460,05	643,85
500	300	1	BN050651.	192,98	227,03	318,27
500	300	2	BN050652.	289,67	340,88	477,20
500	300	3	BN050653.	434,64	511,25	715,67
500	400	1	BN050851.	212,53	250,04	349,79
500	400	2	BN050852.	318,67	374,93	524,82
500	400	3	BN050853.	478,14	562,32	787,36
750	250	1	BN050471.	260,68	306,70	429,59
750	250	2	BN050472.	391,15	460,05	643,85
750	250	3	BN050473.	586,66	690,14	965,85
750	300	1	BN050671.	289,67	340,88	477,20
750	300	2	BN050672.	434,64	511,25	715,67
750	300	3	BN050673.	651,97	766,88	1.073,71
750	400	1	BN050871.	318,67	374,93	524,82
750	400	2	BN050872.	478,14	562,32	787,36
750	400	3	BN050873.	716,87	843,62	1.180,91
900	250	1	BN050491.	312,95	368,28	515,38
900	250	2	BN050492.	469,36	552,08	773,00
900	300	1	BN050691.	347,66	408,98	572,43
900	300	2	BN050692.	521,49	613,53	858,91
900	400	1	BN050891.	382,24	449,67	630,02
900	400	2	BN050892.	573,63	674,84	944,70
1000	250	1	BN050411.	347,66	408,98	572,43
1000	250	2	BN050412.	521,49	613,53	858,91
1000	300	1	BN050611.	386,37	454,46	635,87
1000	300	2	BN050612.	579,22	681,63	954,28
1000	400	1	BN050811.	424,67	499,68	699,71
1000	400	2	BN050812.	637,34	749,85	1.049,50

Castors for castor plate

Spare part. H102 mm, Ø75 mm. Max 100 kg. per castor.

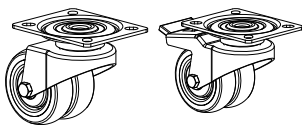

Type	Item no.	Price EUR
Without brake	B400001025	43,36
With brake	B400001125	52,80

PLINTHS

WOODEN & STEEL PLINTHS

Painted and veneered plinths are FSC-certified.

Wooden plinth

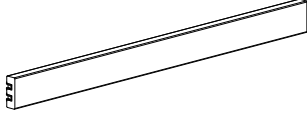
Incl. snapfix. H71 mm. Cannot be used with castors.	Module mm	Item no.	Melamine EUR	Painted EUR	Veneer EUR
	500	BN0255.	36,18	42,56	59,72
	750	BN0257.	45,49	53,73	75,41
	900	BN0259.	45,49	53,73	75,41
	1000	BN0251.	53,87	63,31	88,45

Steel plinth

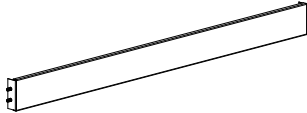
Incl. screws. H71 mm. Cannot be used with castors.	Module mm	Item no.	Steel EUR
	500	BN0275	29,66
	750	BN0277	37,64
	900	BN0279	37,64
	1000	BN0271	44,42

WOODEN PANELS

SINGLE-SIDED - WITH ADJUSTABLE FEET - FOR STEEL AND WOODEN TOP SHELF

Painted and veneered panels are FSC-certified.

WP1 - single-sided, left end panel with adjustable feet - for ST1/ST2/ST3 and WT1

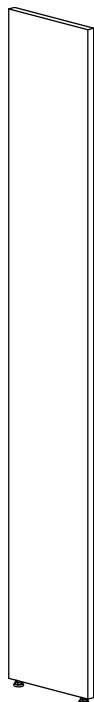

Height mm	Shelf depth mm	Item no.	Melamine EUR	Painted EUR	Veneer EUR
720	250	BN0014232.	82,73	97,49	136,59
720	300	BN0014252.	94,83	111,45	156,28
720	400	BN0014272.	128,48	151,22	211,74
920	250	BN0014332.	106,00	124,75	174,36
920	300	BN0014352.	121,30	142,58	199,90
920	400	BN0014372.	164,26	193,12	270,52
1220	250	BN0014432.	140,32	164,92	231,15
1220	300	BN0014452.	146,43	172,24	241,00
1220	400	BN0014472.	212,40	249,91	349,79
1520	250	BN0014532.	159,47	187,66	262,68
1520	300	BN0014552.	165,45	194,85	272,38
1520	400	BN0014572.	244,85	288,08	402,99
1820	250	BN0014632.	187,00	219,98	308,03
1820	300	BN0014652.	191,39	225,17	314,94
1820	400	BN0014672.	280,10	329,57	461,64
2120	250	BN0014732.	208,41	245,25	343,41
2120	300	BN0014752.	212,40	249,91	349,79
2120	400	BN0014772.	307,36	361,63	506,07

WP1 - single-sided, intermediate panel with adjustable feet - for ST1/ST2/ST3 and WT1

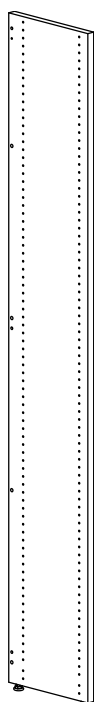

Height mm	Shelf depth mm	Item no.	Melamine EUR	Painted EUR	Veneer EUR
720	250	BN0014234.	82,73	97,49	136,59
720	300	BN0014254.	94,83	111,45	156,28
720	400	BN0014274.	128,48	151,22	211,74
920	250	BN0014334.	106,00	124,75	174,36
920	300	BN0014354.	121,30	142,58	199,90
920	400	BN0014374.	164,26	193,12	270,52
1220	250	BN0014434.	140,32	164,92	231,15
1220	300	BN0014454.	146,43	172,24	241,00
1220	400	BN0014474.	212,40	249,91	349,79
1520	250	BN0014534.	159,47	187,66	262,68
1520	300	BN0014554.	165,45	194,85	272,38
1520	400	BN0014574.	244,85	288,08	402,99
1820	250	BN0014634.	187,00	219,98	308,03
1820	300	BN0014654.	191,39	225,17	314,94
1820	400	BN0014674.	280,10	329,57	461,64
2120	250	BN0014734.	208,41	245,25	343,41
2120	300	BN0014754.	212,40	249,91	349,79
2120	400	BN0014774.	307,36	361,63	506,07

WOODEN PANELS

SINGLE-SIDED - WITH ADJUSTABLE FEET - FOR STEEL AND WOODEN TOP SHELF

Painted and veneered panels are FSC-certified.

WP1 - single-sided right end panel with adjustable feet - for ST1/ST2/ST3 and WT1

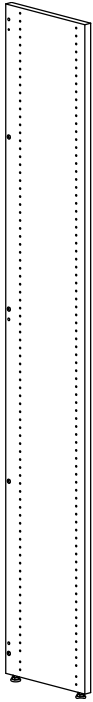

Height mm	Shelf depth mm	Item no.	Melamine EUR	Painted EUR	Veneer EUR
720	250	BN0014233.	82,73	97,49	136,59
720	300	BN0014253.	94,83	111,45	156,28
720	400	BN0014273.	128,48	151,22	211,74
920	250	BN0014333.	106,00	124,75	174,36
920	300	BN0014353.	121,30	142,58	199,90
920	400	BN0014373.	164,26	193,12	270,52
1220	250	BN0014433.	140,32	164,92	231,15
1220	300	BN0014453.	146,43	172,24	241,00
1220	400	BN0014473.	212,40	249,91	349,79
1520	250	BN0014533.	159,47	187,66	262,68
1520	300	BN0014553.	165,45	194,85	272,38
1520	400	BN0014573.	244,85	288,08	402,99
1820	250	BN0014633.	187,00	219,98	308,03
1820	300	BN0014653.	191,39	225,17	314,94
1820	400	BN0014673.	280,10	329,57	461,64
2120	250	BN0014733.	208,41	245,25	343,41
2120	300	BN0014753.	212,40	249,91	349,79
2120	400	BN0014773.	307,36	361,63	506,07

WOODEN PANELS

DOUBLE-SIDED - WITH ADJUSTABLE FEET - FOR STEEL AND WOODEN TOP SHELF

Painted and veneered panels are FSC-certified.

WP1 - double-sided outer end panel with adjustable feet - for ST1/ST2/ST3 and WT1

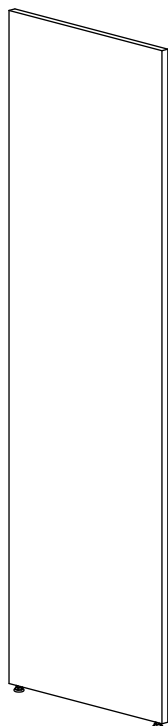

Height mm	Shelf depth mm	Item no.	Melamine EUR	Painted EUR	Veneer EUR
720	250	BN0014245.	121,03	142,31	199,23
720	300	BN0014265.	158,80	186,73	273,58
720	400	BN0014285.	230,76	271,45	380,11
920	250	BN0014345.	154,55	181,81	254,56
920	300	BN0014365.	202,96	238,87	334,50
920	400	BN0014385.	294,86	346,73	485,45
1220	250	BN0014445.	203,89	239,93	336,09
1220	300	BN0014465.	263,74	310,29	434,64
1220	400	BN0014485.	383,31	451,00	631,62
1520	250	BN0014545.	227,70	267,86	374,79
1520	300	BN0014565.	277,84	326,91	457,92
1520	400	BN0014585.	403,52	474,81	664,73
1820	250	BN0014645.	268,53	316,01	442,76
1820	300	BN0014665.	328,24	386,37	540,78
1820	400	BN0014685.	477,47	561,79	786,83
2120	250	BN0014745.	303,37	356,84	499,81
2120	300	BN0014765.	376,92	443,56	620,98
2120	400	BN0014785.	548,63	645,18	903,47

WP1 - double-sided intermediate panel with adjustable feet - for ST1/ST2/ST3 and WT1

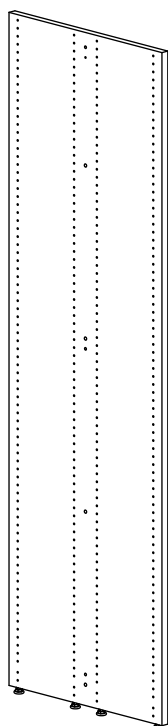

Height mm	Shelf depth mm	Item no.	Melamine EUR	Painted EUR	Veneer EUR
720	250	BN0014244.	121,03	142,31	199,23
720	300	BN0014264.	158,80	186,73	261,61
720	400	BN0014284.	230,76	271,45	380,11
920	250	BN0014344.	154,55	181,81	254,56
920	300	BN0014364.	202,96	238,87	334,50
920	400	BN0014384.	294,86	346,73	485,45
1220	250	BN0014444.	203,89	239,93	336,09
1220	300	BN0014464.	263,74	310,29	434,64
1220	400	BN0014484.	383,31	451,00	631,62
1520	250	BN0014544.	227,70	267,86	374,79
1520	300	BN0014564.	277,84	326,91	457,92
1520	400	BN0014584.	403,52	474,81	664,73
1820	250	BN0014644.	268,53	316,01	442,76
1820	300	BN0014664.	328,24	386,37	540,78
1820	400	BN0014684.	477,47	561,79	786,83
2120	250	BN0014744.	303,37	356,84	499,81
2120	300	BN0014764.	376,92	443,56	620,98
2120	400	BN0014784.	548,63	645,18	903,47

WOODEN PANELS

DOUBLE-SIDED - WITH ADJUSTABLE FEET - FOR STEEL AND WOODEN TOP SHELF

Painted and veneered panels are FSC-certified.

WP2 - double-sided slat outer end panel with milled slat - with adjustable feet - for ST1/ST2/ST3 and WT1

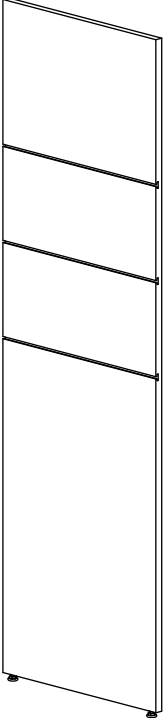
H1520 has 2 slats, H1820 and 2120 has 3 slats.	Height mm	Shelf depth mm	Item no.	Melamine EUR	Painted EUR	Veneer EUR
	1520	250	BN0455451.		430,26	602,36
	1520	300	BN0455651.		489,71	685,35
	1520	400	BN0455851.		563,12	788,03
	1820	250	BN0456451.		485,72	680,16
	1820	300	BN0456651.		559,40	783,24
	1820	400	BN0456851.		643,19	900,54
	2120	250	BN0457451.		560,99	785,63
	2120	300	BN0457651.		642,66	899,61
	2120	400	BN0457851.		738,95	1.034,61

WOODEN PANELS

SINGLE-SIDED - WITH ADJUSTABLE FEET - WITH OVERLAYING TOP PLATE

Painted and veneered panels are FSC-certified.

WP3 - single-sided left end panel with adjustable feet - for WO1

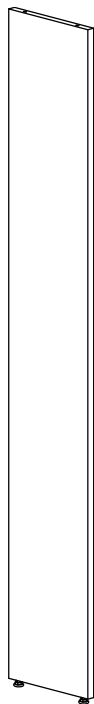

Height mm	Shelf depth mm	Item no.	Melamine EUR	Painted EUR	Veneer EUR
720	250	BN0014236.	82,73	97,49	136,59
720	300	BN0014256.	94,83	111,45	156,28
720	400	BN0014276.	128,48	151,22	211,74
920	250	BN0014336.	106,00	124,75	174,36
920	300	BN0014356.	121,30	142,58	199,90
920	400	BN0014376.	164,26	193,12	270,52
1220	250	BN0014436.	140,32	164,92	231,15
1220	300	BN0014456.	146,43	172,24	241,00
1220	400	BN0014476.	212,40	249,91	349,79
1520	250	BN0014536.	159,47	187,66	262,68
1520	300	BN0014556.	165,45	194,85	272,38
1520	400	BN0014576.	244,85	288,08	402,99
1820	250	BN0014636.	187,00	219,98	308,03
1820	300	BN0014656.	191,39	225,17	314,94
1820	400	BN0014676.	280,10	329,57	461,64
2120	250	BN0014736.	208,41	245,25	343,41
2120	300	BN0014756.	212,40	249,91	349,79
2120	400	BN0014776.	307,36	361,63	506,07

WP3 - single-sided intermediate panel with adjustable feet - for WO1

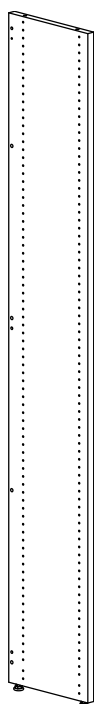

Height mm	Shelf depth mm	Item no.	Melamine EUR	Painted EUR	Veneer EUR
720	250	BN0014238.	82,73	97,49	136,59
720	300	BN0014258.	94,83	111,45	156,28
720	400	BN0014278.	128,48	151,22	211,74
920	250	BN0014338.	106,00	124,75	174,36
920	300	BN0014358.	121,30	142,58	199,90
920	400	BN0014378.	164,26	193,12	270,52
1220	250	BN0014438.	140,32	164,92	231,15
1220	300	BN0014458.	146,43	172,24	241,00
1220	400	BN0014478.	212,40	249,91	349,79
1520	250	BN0014538.	159,47	187,66	262,68
1520	300	BN0014558.	165,45	194,85	272,38
1520	400	BN0014578.	244,85	288,08	402,99
1820	250	BN0014638.	187,00	219,98	308,03
1820	300	BN0014658.	191,39	225,17	314,94
1820	400	BN0014678.	280,10	329,57	461,64
2120	250	BN0014738.	208,41	245,25	343,41
2120	300	BN0014758.	212,40	249,91	349,79
2120	400	BN0014778.	307,36	361,63	506,07

WOODEN PANELS

SINGLE-SIDED - WITH ADJUSTABLE FEET - WITH OVERLAYING TOP PLATE

Painted and veneered panels are FSC-certified.

WP3 - single-sided right end panel with adjustable feet - for WO1

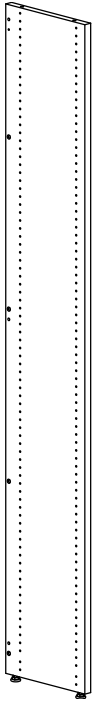

Height mm	Shelf depth mm	Item no.	Melamine EUR	Painted EUR	Veneer EUR
720	250	BN0014237.	82,73	97,49	136,59
720	300	BN0014257.	94,83	111,45	156,28
720	400	BN0014277.	128,48	151,22	211,74
920	250	BN0014337.	106,00	124,75	174,36
920	300	BN0014357.	121,30	142,58	199,90
920	400	BN0014377.	164,26	193,12	270,52
1220	250	BN0014437.	140,32	164,92	231,15
1220	300	BN0014457.	146,43	172,24	241,00
1220	400	BN0014477.	212,40	249,91	349,79
1520	250	BN0014537.	159,47	187,66	262,68
1520	300	BN0014557.	165,45	194,85	272,38
1520	400	BN0014577.	244,85	288,08	402,99
1820	250	BN0014637.	187,00	219,98	308,03
1820	300	BN0014657.	191,39	225,17	314,94
1820	400	BN0014677.	280,10	329,57	461,64
2120	250	BN0014737.	208,41	245,25	343,41
2120	300	BN0014757.	212,40	249,91	349,79
2120	400	BN0014777.	307,36	361,63	506,07

WOODEN PANELS

DOUBLE-SIDED - WITH ADJUSTABLE FEET & OVERLAYING TOP PLATE

Painted and veneered panels are FSC-certified.

WP3 - double-sided outer end panel with adjustable feet - for WO1

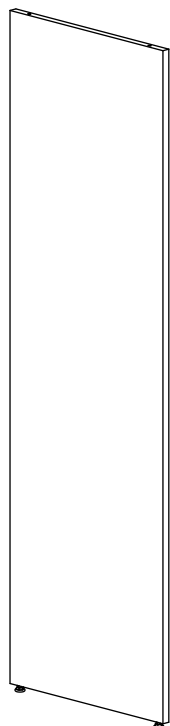

Height mm	Shelf depth mm	Item no.	Melamine EUR	Painted EUR	Veneer EUR
720	250	BN0014249.	121,03	142,31	199,23
720	300	BN0014269.	158,80	186,73	261,61
720	400	BN0014289.	230,76	271,45	380,11
920	250	BN0014349.	154,55	181,81	254,56
920	300	BN0014369.	202,96	238,87	334,50
920	400	BN0014389.	294,86	346,73	485,45
1220	250	BN0014449.	203,89	239,93	336,09
1220	300	BN0014469.	263,74	310,29	434,64
1220	400	BN0014489.	383,31	451,00	631,62
1520	250	BN0014549.	227,70	267,86	374,79
1520	300	BN0014569.	277,84	326,91	457,92
1520	400	BN0014589.	403,52	474,81	664,73
1820	250	BN0014649.	268,53	316,01	442,76
1820	300	BN0014669.	328,24	386,37	540,78
1820	400	BN0014689.	477,47	561,79	786,83
2120	250	BN0014749.	303,37	356,84	499,81
2120	300	BN0014769.	376,92	443,56	620,98
2120	400	BN0014789.	548,63	645,18	903,47

WP3 - double-sided intermediate panel with adjustable feet - for WO1

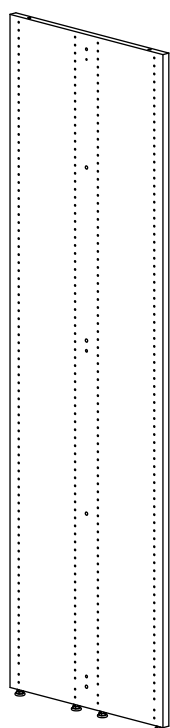

Height mm	Shelf depth mm	Item no.	Melamine EUR	Painted EUR	Veneer EUR
720	250	BN0014248.	121,03	142,31	199,23
720	300	BN0014268.	158,80	186,73	261,61
720	400	BN0014288.	230,76	271,45	380,11
920	250	BN0014348.	154,55	181,81	254,56
920	300	BN0014368.	202,96	238,87	334,50
920	400	BN0014388.	294,86	346,73	485,45
1220	250	BN0014448.	203,89	239,93	336,09
1220	300	BN0014468.	263,74	310,29	434,64
1220	400	BN0014488.	383,31	451,00	631,62
1520	250	BN0014548.	227,70	267,86	374,79
1520	300	BN0014568.	277,84	326,91	457,92
1520	400	BN0014588.	403,52	474,81	664,73
1820	250	BN0014648.	268,53	316,01	442,76
1820	300	BN0014668.	328,24	386,37	540,78
1820	400	BN0014688.	477,47	561,79	786,83
2120	250	BN0014748.	303,37	356,84	499,81
2120	300	BN0014768.	376,92	443,56	620,98
2120	400	BN0014788.	548,63	645,18	903,47

WOODEN PANELS

DOUBLE-SIDED - WITH ADJUSTABLE FEET & OVERLAYING TOP PLATE

Painted and veneered panels are FSC-certified.

WP4 - double-sided slat outer end panel with milled slat and adjustable feet - for WO1

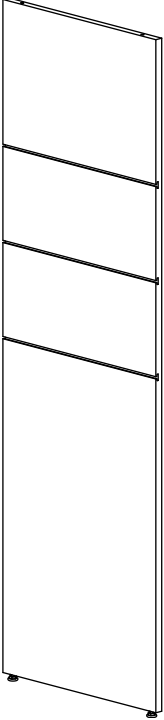
H1520 has 2 slats, H1820 and 2120 has 3 slats.	Height mm	Shelf depth mm	Item no.	Melamine EUR	Painted EUR	Veneer EUR
	1520	250	BN0455491.		430,26	602,36
	1520	300	BN0455691.		489,71	685,35
	1520	400	BN0455891.		563,12	788,03
	1820	250	BN0456491.		485,72	680,16
	1820	300	BN0456691.		559,40	783,24
	1820	400	BN0456891.		643,19	900,54
	2120	250	BN0457491.		560,99	785,63
	2120	300	BN0457691.		642,66	899,61
	2120	400	BN0457891.		738,95	1.034,61

WOODEN PANELS

DOUBLE-SIDED - FOR CASTOR PLATE & TOP SHELF

Painted and veneered panels are FSC-certified.

WP5 - double-sided outer end panel for castor plate - for ST1/ST2/ST3 and WT1

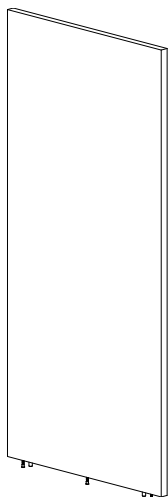

Height mm	Shelf depth mm	Item no.	Melamine EUR	Painted EUR	Veneer EUR
720	250	BN0015245.	121,03	142,31	199,23
720	300	BN0015265.	158,80	186,73	261,61
720	400	BN0015285.	230,76	271,45	380,11
920	250	BN0015345.	154,55	181,81	254,56
920	300	BN0015365.	202,96	238,87	334,50
920	400	BN0015385.	294,86	346,73	485,45
1220	250	BN0015445.	203,89	239,93	336,09
1220	300	BN0015465.	263,74	310,29	434,64
1220	400	BN0015485.	383,31	451,00	631,62
1520	250	BN0015545.	227,70	267,86	374,79
1520	300	BN0015565.	277,84	326,91	457,92
1520	400	BN0015585.	403,52	474,81	664,73

WP5 - double-sided intermediate panel for castor plate - for ST1/ST2/ST3 and WT1

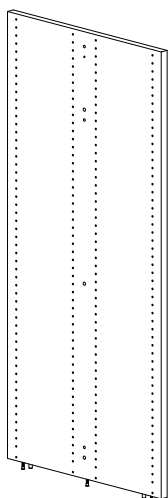

Height mm	Shelf depth mm	Item no.	Melamine EUR	Painted EUR	Veneer EUR
720	250	BN0015244.	121,03	142,31	199,23
720	300	BN0015264.	158,80	186,73	261,61
720	400	BN0015284.	230,76	271,45	380,11
920	250	BN0015344.	154,55	181,81	254,56
920	300	BN0015364.	202,96	238,87	334,50
920	400	BN0015384.	294,86	346,73	485,45
1220	250	BN0015444.	203,89	239,93	336,09
1220	300	BN0015464.	263,74	310,29	434,64
1220	400	BN0015484.	383,31	451,00	631,62
1520	250	BN0015544.	227,70	267,86	374,79
1520	300	BN0015564.	277,84	326,91	457,92
1520	400	BN0015584.	403,52	474,81	664,73

WOODEN PANELS

DOUBLE-SIDED - FOR CASTOR PLATE & TOP SHELF

Painted and veneered panels are FSC-certified.

WP6 - double-sided slat outer end panel with milled slats - for castor plate - for ST1/ST2/ST3 and WT1

H1520 has 2 slats.

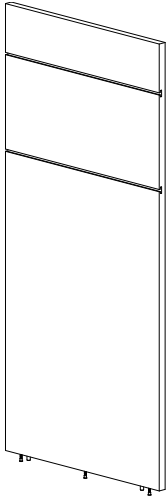

Height mm	Shelf depth mm	Item no.	Melamine EUR	Painted EUR	Veneer EUR
1520	250	BN0465451.		430,26	602,36
1520	300	BN0465651.		489,71	685,35
1520	400	BN0465851.		563,12	788,03

WOODEN PANELS

DOUBLE-SIDED - FOR CASTOR PLATE & OVERLAYING TOP PLATE

Painted and veneered panels are FSC-certified.

WP7 - double-sided outer end panel for castor plate - for WO1

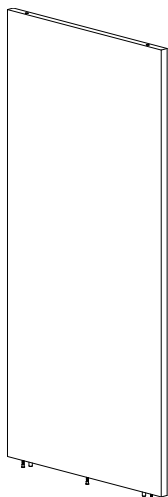

Height mm	Shelf depth mm	Item no.	Melamine EUR	Painted EUR	Veneer EUR
720	250	BN0015249.	121,03	142,31	199,23
720	300	BN0015269.	158,80	186,73	261,61
720	400	BN0015289.	230,76	271,45	380,11
920	250	BN0015349.	154,55	181,81	254,56
920	300	BN0015369.	202,96	238,87	334,50
920	400	BN0015389.	294,86	346,73	485,45
1220	250	BN0015449.	203,89	239,93	336,09
1220	300	BN0015469.	263,74	310,29	434,64
1220	400	BN0015489.	383,31	451,00	631,62
1520	250	BN0015549.	227,70	267,86	374,79
1520	300	BN0015569.	277,84	326,91	457,92
1520	400	BN0015589.	403,52	474,81	664,73

WP7 - double-sided intermediate panel for castor plate - for WO1

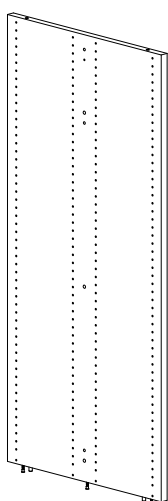

Height mm	Shelf depth mm	Item no.	Melamine EUR	Painted EUR	Veneer EUR
720	250	BN0015248.	121,03	142,31	199,23
720	300	BN0015268.	158,80	186,73	261,61
720	400	BN0015288.	230,76	271,45	380,11
920	250	BN0015348.	154,55	181,81	254,56
920	300	BN0015368.	202,96	238,87	334,50
920	400	BN0015388.	294,86	346,73	485,45
1220	250	BN0015448.	203,89	239,93	336,09
1220	300	BN0015468.	263,74	310,29	434,64
1220	400	BN0015488.	383,31	451,00	631,62
1520	250	BN0015548.	227,70	267,86	374,79
1520	300	BN0015568.	277,84	326,91	457,92
1520	400	BN0015588.	403,52	474,81	664,73

WOODEN PANELS

DOUBLE-SIDED - FOR CASTOR PLATE & OVERLAYING TOP PLATE

Painted and veneered panels are FSC-certified.

WP8 - double-sided slat outer end panel with milled slat - for castor plate - for WO1

H1520 has 2 slats.

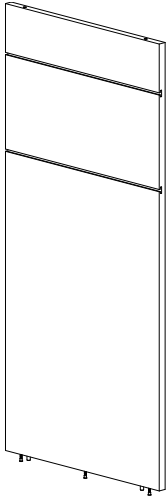

Height mm	Shelf depth mm	Item no.	Melamine EUR	Painted EUR	Veneer EUR
1520	250	BN0465491.		430,26	602,36
1520	300	BN0465691.		489,71	685,35
1520	400	BN0465891.		563,12	788,03

WOODEN PANELS

WOODEN END PANEL BAYS

Use the panel to create a display area on Lingo shelving system. The end panel bay is easily retrofitted on existing double-sided shelving systems with adjustable feet/castor frame (replace existing end panel with end panel bay).
Painted and veneered panels are FSC-certified.

Wooden end panel bay - for bays with top shelf

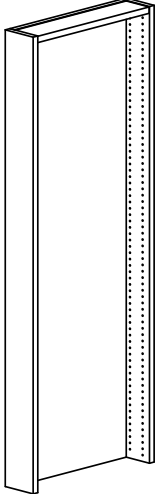
Fastening material included.	Height mm	Shelf depth mm	Width mm	Item no.	Melamine EUR	Painted EUR	Veneer EUR
	720	250	498	BN5402A1.	685,48	806,38	1.129,04
	720	300	598	BN5402B1.	719,66	846,68	1.185,43
	720	400	798	BN5402C1.	788,29	927,41	1.298,35
	920	250	498	BN5403A1.	822,61	967,58	1.354,74
	920	300	598	BN5403B1.	863,57	1.015,99	1.422,57
	920	400	798	BN5403C1.	945,90	1.112,81	1.557,96
	1220	250	498	BN5404A1.	986,99	1.161,22	1.625,79
	1220	300	598	BN5404B1.	1.036,34	1.219,34	1.706,92
	1220	400	798	BN5404C1.	1.135,02	1.335,45	1.869,45
	1520	250	498	BN5405A1.	1.135,02	1.335,45	1.869,45
	1520	300	598	BN5405B1.	1.191,95	1.402,22	1.963,08
	1520	400	798	BN5405C1.	1.305,26	1.535,75	2.150,08
1820	250	498	BN5406A1.	1.305,26	1.535,75	2.150,08	
1820	300	598	BN5406B1.	1.370,57	1.612,49	2.257,41	
1820	400	798	BN5406C1.	1.501,17	1.766,11	2.472,47	
2120	250	498	BN5407A1.	1.370,57	1.612,49	2.257,41	
2120	300	598	BN5407B1.	1.439,19	1.693,22	2.370,46	
2120	400	798	BN5407C1.	1.576,18	1.854,42	2.596,16	

Wooden end panel bay - for bays with overlaying top plate

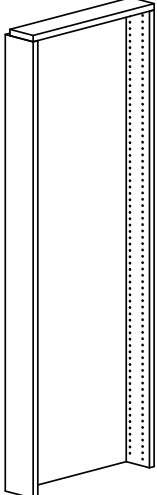
Fastening material included.	Height mm	Shelf depth mm	Width mm	Item no.	Melamine EUR	Painted EUR	Veneer EUR
	720	250	498	BN5402A2.	685,48	806,38	1.129,04
	720	300	598	BN5402B2.	719,66	846,68	1.185,43
	720	400	798	BN5402C2.	788,29	927,41	1.298,35
	920	250	498	BN5403A2.	822,61	967,58	1.354,74
	920	300	598	BN5403B2.	863,57	1.015,99	1.422,57
	920	400	798	BN5403C2.	945,90	1.112,81	1.557,96
	1220	250	498	BN5404A2.	986,99	1.161,22	1.625,79
	1220	300	598	BN5404B2.	1.036,34	1.219,34	1.706,92
	1220	400	798	BN5404C2.	1.135,02	1.335,45	1.869,45
	1520	250	498	BN5405A2.	1.135,02	1.335,45	1.869,45
	1520	300	598	BN5405B2.	1.191,95	1.402,22	1.963,08
	1520	400	798	BN5405C2.	1.305,26	1.535,75	2.150,08
1820	250	498	BN5406A2.	1.305,26	1.535,75	2.150,08	
1820	300	598	BN5406B2.	1.370,57	1.612,49	2.257,41	
1820	400	798	BN5406C2.	1.501,17	1.766,11	2.472,47	
2120	250	498	BN5407A2.	1.370,57	1.612,49	2.257,41	
2120	300	598	BN5407B2.	1.439,19	1.693,22	2.370,46	
2120	400	798	BN5407A2.	1.576,18	1.854,42	2.596,16	

WOODEN PANELS

WOODEN END PANEL BAYS

The functions below are suited for hanging on wooden end panel bays. Painted and veneered products are FSC-certified.

Wooden sign for wooden end panel bay

H368 mm. Incl. fittings.	Width mm	Shelf depth mm	Item no.	Melamine EUR	Painted EUR	Veneer EUR
	498	250	BN541A.	147,50	173,57	242,86
	598	300	BN541B.	171,84	202,03	283,02
	798	400	BN541C.	206,15	242,46	339,55

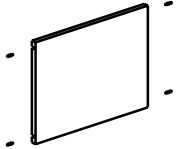

Steel display shelf for wooden end panel bay

H280 mm. Incl. fittings.	Width mm	Shelf depth mm	Item no.	Steel EUR
	498	250	BN542A	118,10
	598	300	BN542B	130,87
	798	400	BN542C	140,18

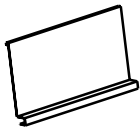

Wooden brochure rack for wooden end panel bay

H140 mm. Front and three adjustable dividers in acrylic glass. Incl. fittings.	Width mm	Shelf depth mm	Item no.	Melamine EUR	Painted EUR	Veneer EUR
	498	250	BN543A.	298,19	350,72	491,04
	598	300	BN543B.	346,73	407,91	570,97
	798	400	BN543C.	388,09	456,59	639,20

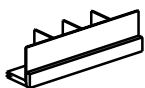

CONNECTION ELEMENTS

WOODEN BACK PANELS - FOR ADJUSTABLE FEET

Painted and veneered panels are FSC-certified.

WBP1 - high wooden back panel - for ST1 (standard depth)/ST2/ST3, WT1/WT3 (standard depth) and WO1

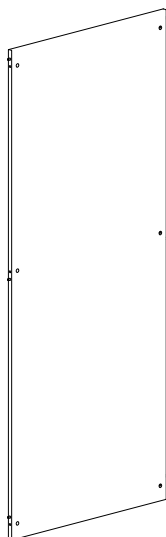

Height mm	Module mm	Item no.	Melamine EUR	Painted EUR	Veneer EUR
720	500	BN015254.	69,43	81,53	114,38
720	750	BN015274.	104,01	122,49	171,84
720	900	BN015294.	130,07	152,95	214,26
720	1000	BN015214.	138,72	163,32	228,49
920	500	BN015354.	88,71	104,41	146,43
920	750	BN015374.	133,13	156,54	219,32
920	900	BN015394.	166,38	195,78	274,11
920	1000	BN015314.	177,42	208,68	291,80
1220	500	BN015454.	118,37	139,38	195,24
1220	750	BN015474.	177,95	209,21	292,73
1220	900	BN015494.	214,53	252,43	353,65
1220	1000	BN015414.	236,74	278,50	389,69
1520	500	BN015554.	144,97	170,51	238,87
1520	750	BN015574.	217,46	255,89	358,17
1520	900	BN015594.	265,87	312,82	438,24
1520	1000	BN015514.	290,34	341,68	477,87
1820	500	BN015654.	168,25	197,90	276,77
1820	750	BN015674.	252,17	296,59	415,36
1820	900	BN015694.	313,22	368,68	515,77
1820	1000	BN015614.	336,09	395,41	553,55
2120	500	BN015754.	194,45	228,49	320,13
2120	750	BN015774.	291,27	342,87	479,60
2120	900	BN015794.	361,49	425,33	595,71
2120	1000	BN015714.	388,23	456,86	639,60

WBP2 - low wooden back panel - for ST1 (full depth & double-sided) and WT1/WT3 (full depth & double-sided)

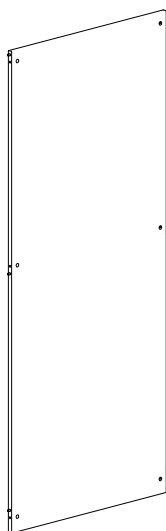

Height mm	Module mm	Item no.	Melamine EUR	Painted EUR	Veneer EUR
720	500	BN015256.	69,43	81,53	114,38
720	750	BN015276.	104,01	122,49	171,84
720	900	BN015296.	130,07	152,95	214,26
720	1000	BN015216.	138,72	163,32	228,49
920	500	BN015356.	88,71	104,41	146,43
920	750	BN015376.	133,13	156,54	219,32
920	900	BN015396.	166,38	195,78	274,11
920	1000	BN015316.	177,42	208,68	291,80
1220	500	BN015456.	118,37	139,38	195,24
1220	750	BN015476.	177,95	209,21	292,73
1220	900	BN015496.	214,53	252,43	353,65
1220	1000	BN015416.	236,74	278,50	389,69
1520	500	BN015556.	144,97	170,51	238,87
1520	750	BN015576.	217,46	255,89	358,17
1520	900	BN015596.	265,87	312,82	438,24
1520	1000	BN015516.	290,34	341,68	477,87
1820	500	BN015656.	168,25	197,90	276,77
1820	750	BN015676.	252,17	296,59	415,36
1820	900	BN015696.	313,22	368,68	515,77
1820	1000	BN015616.	336,09	395,41	553,55
2120	500	BN015756.	194,45	228,49	320,13
2120	750	BN015776.	291,27	342,87	479,60
2120	900	BN015796.	361,49	425,33	595,71
2120	1000	BN015716.	388,23	456,86	639,60

CONNECTION ELEMENTS

WOODEN BACK PANELS - FOR CASTOR PLATE

Painted and veneered panels are FSC-certified.

WBP3 - high wooden back panel - for ST1 (standard depth)/ST2/ST3, WT1/WT3 (standard depth) and WO1

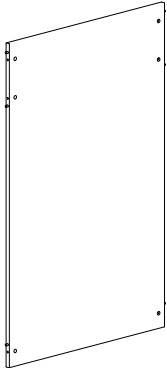

Height mm	Module mm	Item no.	Melamine EUR	Painted EUR	Veneer EUR
720	500	BN016254.	69,43	81,53	114,38
720	750	BN016274.	104,01	122,49	171,84
720	900	BN016294.	130,07	152,95	214,26
720	1000	BN016214.	138,72	163,32	228,49
920	500	BN016354.	88,71	104,41	146,43
920	750	BN016374.	133,13	156,54	219,32
920	900	BN016394.	166,38	195,78	274,11
920	1000	BN016314.	177,42	208,68	291,80
1220	500	BN016454.	118,37	139,38	195,24
1220	750	BN016474.	177,95	209,21	292,73
1220	900	BN016494.	214,53	252,43	353,65
1220	1000	BN016414.	236,74	278,50	389,69
1520	500	BN016554.	144,97	170,51	238,87
1520	750	BN016574.	217,46	255,89	358,17
1520	900	BN016594.	265,87	312,82	438,24
1520	1000	BN016514.	290,34	341,68	477,87

WBP4 - low wooden back panel - for ST1 (full depth & double-sided) and WT1/WT3 (full depth & double-sided)

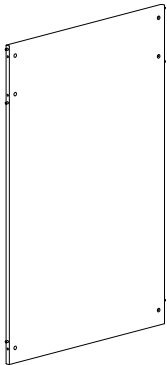

Height mm	Module mm	Item no.	Melamine EUR	Painted EUR	Veneer EUR
720	500	BN016256.	69,43	81,53	114,38
720	750	BN016276.	104,01	122,49	171,84
720	900	BN016296.	130,07	152,95	214,26
720	1000	BN016216.	138,72	163,32	228,49
920	500	BN016356.	88,71	104,41	146,43
920	750	BN016376.	133,13	156,54	219,32
920	900	BN016396.	166,38	195,78	274,11
920	1000	BN016316.	177,42	208,68	291,80
1220	500	BN016456.	118,37	139,38	195,24
1220	750	BN016476.	177,95	209,21	292,73
1220	900	BN016496.	214,53	252,43	353,65
1220	1000	BN016416.	236,74	278,50	389,69
1520	500	BN016556.	144,97	170,51	238,87
1520	750	BN016576.	217,46	255,89	358,17
1520	900	BN016596.	265,87	312,82	438,24
1520	1000	BN016516.	290,34	341,68	477,87

CONNECTION ELEMENTS

STEEL BACK FRAME

To ensure correct stability, double-sided shelvings H1820 mm and H2120 mm with back frame must have an additional steel back frames installed depending on number of bays. Configurations for freestanding bays include one additional back frame. Back frame for intermediate bays must be ordered separately, see overview page 11.

Steel back frame

Use for heights:
720/920/1220/1820/2120
mm. With fittings.

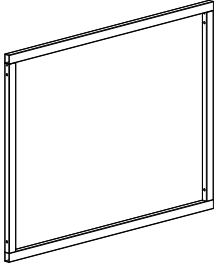

Module mm	Bay	Item no.	Price EUR
500	Freestanding	BN01054ZZZ8	79,93
750	Freestanding	BN01074ZZZ8	79,93
900	Freestanding	BN01094ZZZ8	79,93
1000	Freestanding	BN01014ZZZ8	90,57
500	Intermediate	BN01054ZZZ9	79,93
750	Intermediate	BN01074ZZZ9	79,93
900	Intermediate	BN01094ZZZ9	79,93
1000	Intermediate	BN01014ZZZ9	90,57

Additional steel back frame

Use for correct stability when
constructing more than one bay.
See guide on page 11.
With fittings.

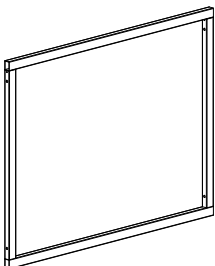

Module mm	Bay	Item no.	Price EUR
500	Freestanding	BN01254ZZZ3	79,93
750	Freestanding	BN01274ZZZ3	79,93
900	Freestanding	BN01294ZZZ3	79,93
1000	Freestanding	BN01214ZZZ3	90,57
500	Intermediate	BN01254ZZZ2	79,93
750	Intermediate	BN01274ZZZ2	79,93
900	Intermediate	BN01294ZZZ2	79,93
1000	Intermediate	BN01214ZZZ2	90,57
500	Outer	BN01254ZZZ1	79,93
750	Outer	BN01274ZZZ1	79,93
900	Outer	BN01294ZZZ1	79,93
1000	Outer	BN01214ZZZ1	90,57

CONNECTION ELEMENTS

CROSS BRACES

Galvanized cross braces - low

Use for heights: 720/920/1220 mm.	Module mm	Item no.	Price EUR
	500	BN02154	22,21
	750	BN02174	22,21
	900	BN02194	22,21
	1000	BN02114	22,21

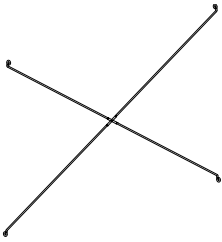

Galvanized cross braces - high

Use for heights: 1520/1820/2120 mm Middle shelf must be screwed on to the end panel when cross brace are used.	Module mm	Item no.	Price EUR
	500	BN02156	22,21
	750	BN02176	22,21
	900	BN02196	22,21
	1000	BN02116	22,21

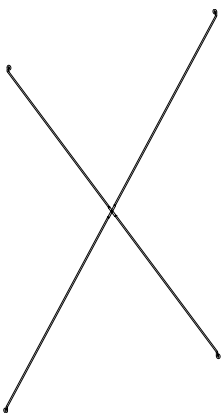



The Book LED lighting armature can be fitted on wooden top shelves and can be mounted over 1, 2 and 3 bays by use of connect fittings. Continuous runs require connect fitting.

The armature is CE-approved and available in white and steel as standard. For other colours, please ask customer service.

Armature

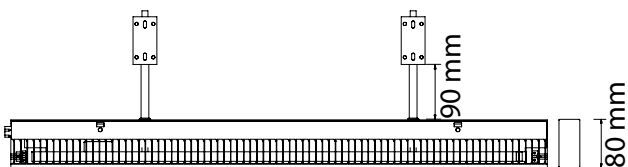

Model showing 2 bearing arms incl. light tube and louvre. Armature housing in aluminium.

Standard bearing arms



To be mounted on top of top shelf.

Front edge bearing arms





To be mounted on frontedge of predrilled top shelf/top plate (special request)

LIGHTING

BOOK LED LIGHTING

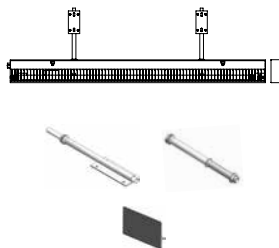
Below you will find a list of products needed when ordering lighting for 1, 2 or 3 bays. For 4 or more bays, you must use a combination of the armatures for 1, 2 or 3 bays by connecting the armatures with a connect fitting. Eg. for 10 bays, you can either use 5 x 2 bays (with 4 connect fittings) or 3 x 3 bays and 1 x 1 bay (with 3 connect fittings).

1 bay		Item no.	Price EUR	
	Armature, module 50	B3900170527	762,09	
	Armature, module 75	B3900170777	762,09	
	Armature, module 90	B3900170927	762,09	
	Armature, module 100	B3900171032	875,27	
	Bearing arms, 2 pcs., standard	B39001512	160,13	
	Bearing arms, 2 pcs., front edge	B39001522	160,13	
	End covers, 2 pcs.	B390011	97,76	
2 bays		Item no.	Price EUR	
	Armature, module 50 + 50	B3900171054	1.071,32	
	Armature, module 75 + 75	B3900171554	1.071,32	
	Armature, module 90 + 90	B3900171854	1.199,93	
	Armature, module 100 + 100	B3900172064	1.297,81	
	Bearing arms, 2 pcs., standard or	B39001512	160,13	
	Bearing arms, 2 pcs., front edge	B39001522	160,13	
		End covers, 2 pcs.	B390011	97,76
	3 bays		Item no.	Price EUR
		Armature, module 50 + 50 + 50	B3900171580	1.064,27
		Armature, module 75 + 75 + 75	B3900172330	1.596,27
Armature, module 90 + 90 + 90		B3900172780	1.799,76	
Armature, module 100 + 100 + 100		B3900173095	1.946,99	
Bearing arms, 3 pcs., standard or		B39001513	223,97	
Bearing arms, 3 pcs., front edge		B39001523	223,97	
		End covers, 2 pcs.	B390011	97,76
Cable 3 x 1.5 mm ² , L2500 mm		Item no.	Price EUR	
			B390013	72,49
Connect fitting		Item no.	Price EUR	
		B390012	20,88	

LINGO ROUND SHELVING SYSTEM

BBN201 - 26° - STEEL BACK FRAME - ADJUSTABLE FEET - FOR TOP SHELF



LINGO ROUND SHELVING SYSTEM

BBN201 - 26° - STEEL BACK FRAME - ADJUSTABLE FEET - FOR TOP SHELF

Round shelving system with wooden panels and steel back frame. To be used with top shelf.
Freestanding bay includes 2 end wooden panels and 1 or 2 steel back frame depending on height.
Intermediate bay includes 1 intermediate wooden panel and 1 steel back frame.

- Prices based on steel price group 1 and wooden price group A (see Design Options pages 6-9).
- For top shelves, see from page 340
- For shelves, see from page 328

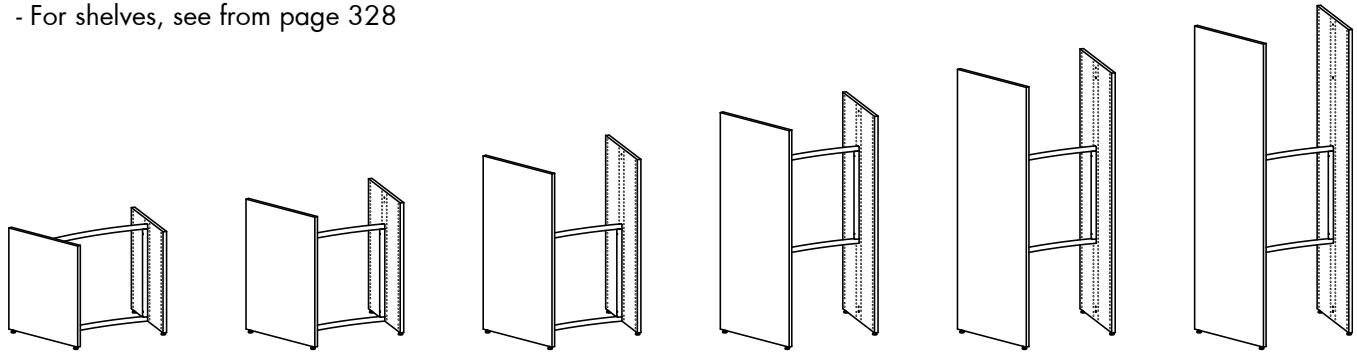

Double-sided freestanding bay - H720/920/1220/1520/1820/2120 mm

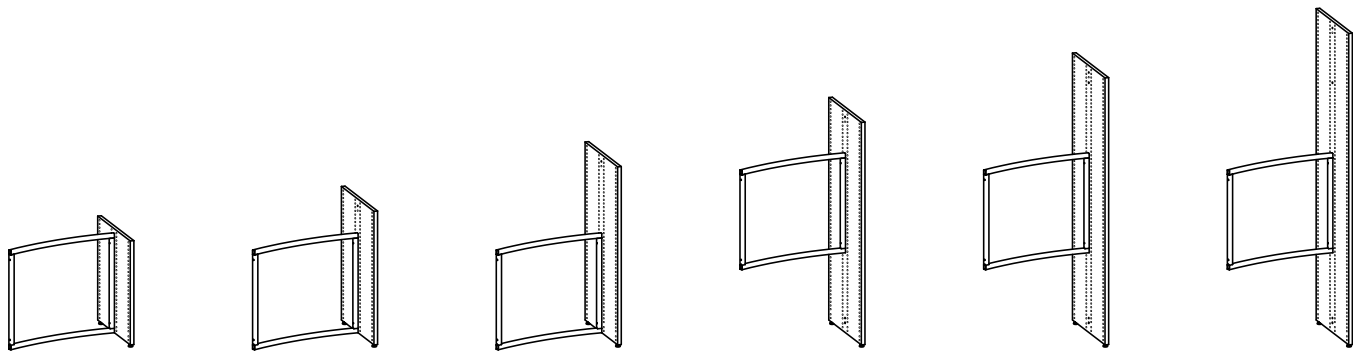

Double-sided intermediate bay - H720/920/1220/1520/1820/2120 mm

LINGO ROUND SHELVING SYSTEM

26° - STEEL BACK FRAME - ADJUSTABLE FEET - FOR TOP SHELF

Painted and veneered Lingo Shelving Systems are FSC-certified.

H720 mm

No. of bays	Item no. Freestanding bay	Melamine EUR	Painted EUR	Veneer EUR	Item no. Intermediate bay	Melamine EUR	Painted EUR	Veneer EUR
1	BBN2011260100060.	590,25	646,11	819,81	BBN2014260100060.	431,45	459,38	534,26
2	BBN2011260200060.	1.021,70	1.105,49	1.354,07	BBN2014260200060.	862,90	918,76	1.068,52
3	BBN2011260300060.	1.453,15	1.564,87	1.888,33	BBN2014260300060.	1.294,35	1.378,14	1.602,78
4	BBN2011260400060.	1.884,60	2.024,25	2.422,59	BBN2014260400060.	1.725,80	1.837,52	2.137,04
5	BBN2011260500060.	2.316,05	2.483,63	2.956,85	BBN2014260500060.	2.157,25	2.296,90	2.671,30
6	BBN2011260600060.	2.747,50	2.943,01	3.491,11	BBN2014260600060.	2.588,70	2.756,28	3.205,56
7	BBN2011260700060.	3.178,95	3.402,39	4.025,37	BBN2014260700060.	3.020,15	3.215,66	3.739,82
8	BBN2011260800060.	3.610,40	3.861,77	4.559,63				
9	BBN2011260900060.	4.041,85	4.321,15	5.093,89				
10	BBN2011261000060.	4.473,30	4.780,53	5.628,15				
11	BBN2011261100060.	4.904,75	5.239,91	6.162,41				
12	BBN2011261200060.	5.336,20	5.699,29	6.696,67				

H920 mm

No. of bays	Item no. Freestanding bay	Melamine EUR	Painted EUR	Veneer EUR	Item no. Intermediate bay	Melamine EUR	Painted EUR	Veneer EUR
1	BBN2011360100060.	678,57	750,39	941,65	BBN2014360100060.	475,61	511,52	607,15
2	BBN2011360200060.	1.154,18	1.261,91	1.548,80	BBN2014360200060.	951,22	1.023,04	1.214,30
3	BBN2011360300060.	1.629,79	1.773,43	2.155,95	BBN2014360300060.	1.426,83	1.534,56	1.821,45
4	BBN2011360400060.	2.105,40	2.284,95	2.763,10	BBN2014360400060.	1.902,44	2.046,08	2.428,60
5	BBN2011360500060.	2.581,01	2.796,47	3.370,25	BBN2014360500060.	2.378,05	2.557,60	3.035,75
6	BBN2011360600060.	3.056,62	3.307,99	3.977,40	BBN2014360600060.	2.853,66	3.069,12	3.642,90
7	BBN2011360700060.	3.532,23	3.819,51	4.584,55	BBN2014360700060.	3.329,27	3.580,64	4.250,05
8	BBN2011360800060.	4.007,84	4.331,03	5.191,70				
9	BBN2011360900060.	4.483,45	4.842,55	5.798,85				
10	BBN2011361000060.	4.959,06	5.354,07	6.406,00				
11	BBN2011361100060.	5.434,67	5.865,59	7.013,15				
12	BBN2011361200060.	5.910,28	6.377,11	7.620,30				

H1220 mm

No. of bays	Item no. Freestanding bay	Melamine EUR	Painted EUR	Veneer EUR	Item no. Intermediate bay	Melamine EUR	Painted EUR	Veneer EUR
1	BBN2011460100060.	800,13	893,23	1.141,93	BBN2014460100060.	536,39	582,94	707,29
2	BBN2011460200060.	1.336,52	1.476,17	1.849,22	BBN2014460200060.	1.072,78	1.165,88	1.414,58
3	BBN2011460300060.	1.872,91	2.059,11	2.556,51	BBN2014460300060.	1.609,17	1.748,82	2.121,87
4	BBN2011460400060.	2.409,30	2.642,05	3.263,80	BBN2014460400060.	2.145,56	2.331,76	2.829,16
5	BBN2011460500060.	2.945,69	3.224,99	3.971,09	BBN2014460500060.	2.681,95	2.914,70	3.536,45
6	BBN2011460600060.	3.482,08	3.807,93	4.678,38	BBN2014460600060.	3.218,34	3.497,64	4.243,74
7	BBN2011460700060.	4.018,47	4.390,87	5.385,67	BBN2014460700060.	3.754,73	4.080,58	4.951,03
8	BBN2011460800060.	4.554,86	4.973,81	6.092,96				
9	BBN2011460900060.	5.091,25	5.556,75	6.800,25				
10	BBN2011461000060.	5.627,64	6.139,69	7.507,54				
11	BBN2011461100060.	6.164,03	6.722,63	8.214,83				
12	BBN2011461200060.	6.700,42	7.305,57	8.922,12				

LINGO ROUND SHELVING SYSTEM

26° - STEEL BACK FRAME - ADJUSTABLE FEET - FOR TOP SHELF

Painted and veneered Lingo Shelving Systems are FSC-certified.

H1520 mm

No. of bays	Item no. Freestanding bay	Melamine EUR	Painted EUR	Veneer EUR	Item no. Intermediate bay	Melamine EUR	Painted EUR	Veneer EUR
1	BBN2011560100060.	828,33	926,47	1.188,49	BBN2014560100060.	550,49	599,56	730,57
2	BBN2011560200060.	1.378,82	1.526,03	1.919,06	BBN2014560200060.	1.100,98	1.199,12	1.461,14
3	BBN2011560300060.	1.929,31	2.125,59	2.649,63	BBN2014560300060.	1.651,47	1.798,68	2.191,71
4	BBN2011560400060.	2.479,80	2.725,15	3.380,20	BBN2014560400060.	2.201,96	2.398,24	2.922,28
5	BBN2011560500060.	3.030,29	3.324,71	4.110,77	BBN2014560500060.	2.752,45	2.997,80	3.652,85
6	BBN2011560600060.	3.580,78	3.924,27	4.841,34	BBN2014560600060.	3.302,94	3.597,36	4.383,42
7	BBN2011560700060.	4.131,27	4.523,83	5.571,91	BBN2014560700060.	3.853,43	4.196,92	5.113,99
8	BBN2011560800060.	4.681,76	5.123,39	6.302,48				
9	BBN2011560900060.	5.232,25	5.722,95	7.033,05				
10	BBN2011561000060.	5.782,74	6.322,51	7.763,62				
11	BBN2011561100060.	6.333,23	6.922,07	8.494,19				
12	BBN2011561200060.	6.883,72	7.521,63	9.224,76				

H1820 mm

No. of bays	Item no. Freestanding bay	Melamine EUR	Painted EUR	Veneer EUR	Item no. Intermediate bay	Melamine EUR	Painted EUR	Veneer EUR
1	BBN2011660100060.	929,13	1.045,39	1.354,21	BBN2014660100060.	600,89	659,02	813,43
2	BBN2011660200060.	1.530,02	1.704,41	2.167,64	BBN2014660200060.	1.201,78	1.318,04	1.626,86
3	BBN2011660300060.	2.130,91	2.363,43	2.981,07	BBN2014660300060.	1.802,67	1.977,06	2.440,29
4	BBN2011660400060.	2.731,80	3.022,45	3.794,50	BBN2014660400060.	2.403,56	2.636,08	3.253,72
5	BBN2011660500060.	3.332,69	3.681,47	4.607,93	BBN2014660500060.	3.004,45	3.295,10	4.067,15
6	BBN2011660600060.	3.933,58	4.340,49	5.421,36	BBN2014660600060.	3.605,34	3.954,12	4.880,58
7	BBN2011660700060.	4.534,47	4.999,51	6.234,79	BBN2014660700060.	4.206,23	4.613,14	5.694,01
8	BBN2011660800060.	5.135,36	5.658,53	7.048,22				
9	BBN2011660900060.	5.736,25	6.317,55	7.861,65				
10	BBN2011661000060.	6.337,14	6.976,57	8.675,08				
11	BBN2011661100060.	6.938,03	7.635,59	9.488,51				
12	BBN2011661200060.	7.538,92	8.294,61	10.301,94				

H2120 mm

No. of bays	Item no. Freestanding bay	Melamine EUR	Painted EUR	Veneer EUR	Item no. Intermediate bay	Melamine EUR	Painted EUR	Veneer EUR
1	BBN2011760100060.	1.026,49	1.159,77	1.514,61	BBN2014760100060.	649,57	716,21	893,63
2	BBN2011760200060.	1.676,06	1.875,98	2.408,24	BBN2014760200060.	1.299,14	1.432,42	1.787,26
3	BBN2011760300060.	2.325,63	2.592,19	3.301,87	BBN2014760300060.	1.948,71	2.148,63	2.680,89
4	BBN2011760400060.	2.975,20	3.308,40	4.195,50	BBN2014760400060.	2.598,28	2.864,84	3.574,52
5	BBN2011760500060.	3.624,77	4.024,61	5.089,13	BBN2014760500060.	3.247,85	3.581,05	4.468,15
6	BBN2011760600060.	4.274,34	4.740,82	5.982,76	BBN2014760600060.	3.897,42	4.297,26	5.361,78
7	BBN2011760700060.	4.923,91	5.457,03	6.876,39	BBN2014760700060.	4.546,99	5.013,47	6.255,41
8	BBN2011760800060.	5.573,48	6.173,24	7.770,02				
9	BBN2011760900060.	6.223,05	6.889,45	8.663,65				
10	BBN2011761000060.	6.872,62	7.605,66	9.557,28				
11	BBN2011761100060.	7.522,19	8.321,87	10.450,91				
12	BBN2011761200060.	8.171,76	9.038,08	11.344,54				

LINGO ROUND SHELVING SYSTEM

BBN201 - 26° - HIGH STEEL BACK PANEL - ADJUSTABLE FEET - FOR TOP SHELF



LINGO ROUND SHELVING SYSTEM

BBN201 - 26° - HIGH STEEL BACK PANEL - ADJUSTABLE FEET - FOR TOP SHELF

Round shelving system with wooden panels and high steel back panel.

To be used with top shelf WT5 standard depth top shelf.

Freestanding bay includes 2 wooden end panels and 1 high steel back panel.

Intermediate bay includes 1 intermediate wooden panel and 1 high steel back panel.

- Prices based on steel price group 1 and wooden price group A (see Design Options pages 6-9).

- For top shelves, see from page 340

- For shelves, see from page 328

- For castor frame, see page 347

- For end panel bay, see page 358

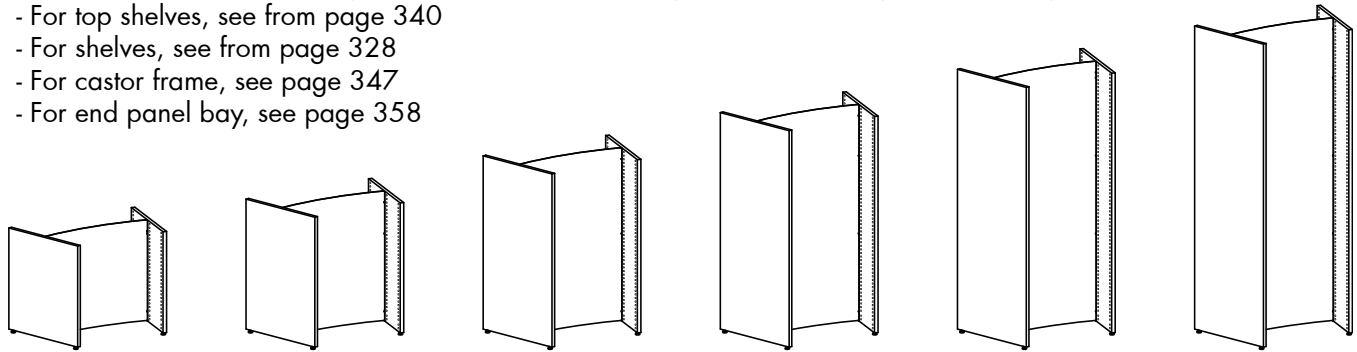

Double-sided freestanding bay - H720/920/1220/1520/1820/2120 mm

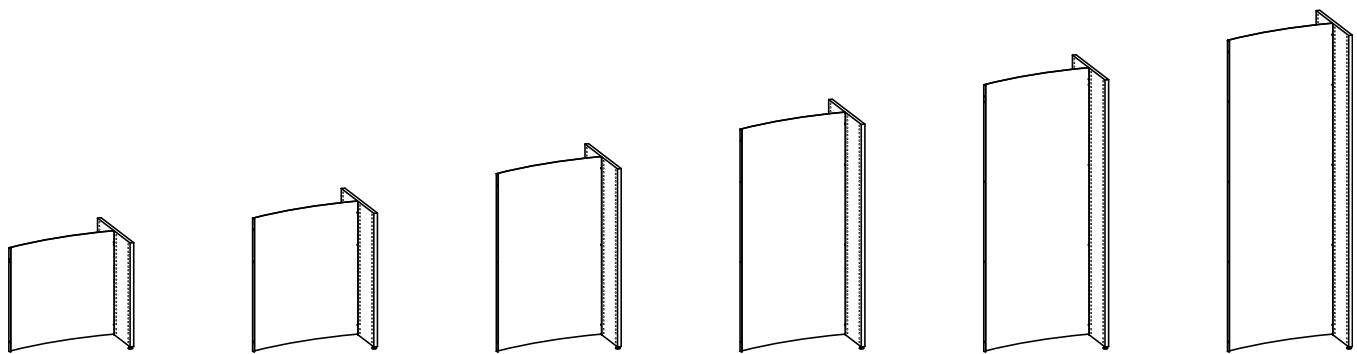

Double-sided intermediate bay - H720/920/1220/1520/1820/2120 mm

LINGO ROUND SHELVING SYSTEM

26° - HIGH STEEL BACK PANEL - ADJUSTABLE FEET - FOR TOP SHELF

Painted and veneered Lingo Shelving Systems are FSC-certified.

H720 mm

No. of bays	Item no. Freestanding bay	Melamine EUR	Painted EUR	Veneer EUR	Item no. Intermediate bay	Melamine EUR	Painted EUR	Veneer EUR
1	BBN2011260100070.	522,15	578,01	751,71	BBN2014260100070.	363,35	391,28	466,16
2	BBN2011260200070.	885,50	969,29	1.217,87	BBN2014260200070.	726,70	782,56	932,32
3	BBN2011260300070.	1.248,85	1.360,57	1.684,03	BBN2014260300070.	1.090,05	1.173,84	1.398,48
4	BBN2011260400070.	1.612,20	1.751,85	2.150,19	BBN2014260400070.	1.453,40	1.565,12	1.864,64
5	BBN2011260500070.	1.975,55	2.143,13	2.616,35	BBN2014260500070.	1.816,75	1.956,40	2.330,80
6	BBN2011260600070.	2.338,90	2.534,41	3.082,51	BBN2014260600070.	2.180,10	2.347,68	2.796,96
7	BBN2011260700070.	2.702,25	2.925,69	3.548,67	BBN2014260700070.	2.543,45	2.738,96	3.263,12
8	BBN2011260800070.	3.065,60	3.316,97	4.014,83				
9	BBN2011260900070.	3.428,95	3.708,25	4.480,99				
10	BBN2011261000070.	3.792,30	4.099,53	4.947,15				
11	BBN2011261100070.	4.155,65	4.490,81	5.413,31				
12	BBN2011261200070.	4.519,00	4.882,09	5.879,47				

H920 mm

No. of bays	Item no. Freestanding bay	Melamine EUR	Painted EUR	Veneer EUR	Item no. Intermediate bay	Melamine EUR	Painted EUR	Veneer EUR
1	BBN2011360100070.	667,27	739,09	930,35	BBN2014360100070.	464,31	500,22	595,85
2	BBN2011360200070.	1.131,58	1.239,31	1.526,20	BBN2014360200070.	928,62	1.000,44	1.191,70
3	BBN2011360300070.	1.595,89	1.739,53	2.122,05	BBN2014360300070.	1.392,93	1.500,66	1.787,55
4	BBN2011360400070.	2.060,20	2.239,75	2.717,90	BBN2014360400070.	1.857,24	2.000,88	2.383,40
5	BBN2011360500070.	2.524,51	2.739,97	3.313,75	BBN2014360500070.	2.321,55	2.501,10	2.979,25
6	BBN2011360600070.	2.988,82	3.240,19	3.909,60	BBN2014360600070.	2.785,86	3.001,32	3.575,10
7	BBN2011360700070.	3.453,13	3.740,41	4.505,45	BBN2014360700070.	3.250,17	3.501,54	4.170,95
8	BBN2011360800070.	3.917,44	4.240,63	5.101,30				
9	BBN2011360900070.	4.381,75	4.740,85	5.697,15				
10	BBN2011361000070.	4.846,06	5.241,07	6.293,00				
11	BBN2011361100070.	5.310,37	5.741,29	6.888,85				
12	BBN2011361200070.	5.774,68	6.241,51	7.484,70				

H1220 mm

No. of bays	Item no. Freestanding bay	Melamine EUR	Painted EUR	Veneer EUR	Item no. Intermediate bay	Melamine EUR	Painted EUR	Veneer EUR
1	BBN2011460100070.	874,08	967,18	1.215,88	BBN2014460100070.	610,34	656,89	781,24
2	BBN2011460200070.	1.484,42	1.624,07	1.997,12	BBN2014460200070.	1.220,68	1.313,78	1.562,48
3	BBN2011460300070.	2.094,76	2.280,96	2.778,36	BBN2014460300070.	1.831,02	1.970,67	2.343,72
4	BBN2011460400070.	2.705,10	2.937,85	3.559,60	BBN2014460400070.	2.441,36	2.627,56	3.124,96
5	BBN2011460500070.	3.315,44	3.594,74	4.340,84	BBN2014460500070.	3.051,70	3.284,45	3.906,20
6	BBN2011460600070.	3.925,78	4.251,63	5.122,08	BBN2014460600070.	3.662,04	3.941,34	4.687,44
7	BBN2011460700070.	4.536,12	4.908,52	5.903,32	BBN2014460700070.	4.272,38	4.598,23	5.468,68
8	BBN2011460800070.	5.146,46	5.565,41	6.684,56				
9	BBN2011460900070.	5.756,80	6.222,30	7.465,80				
10	BBN2011461000070.	6.367,14	6.879,19	8.247,04				
11	BBN2011461100070.	6.977,48	7.536,08	9.028,28				
12	BBN2011461200070.	7.587,82	8.192,97	9.809,52				

LINGO ROUND SHELVING SYSTEM

26° - HIGH STEEL BACK PANEL - ADJUSTABLE FEET - FOR TOP SHELF

Painted and veneered Lingo Shelving Systems are FSC-certified.

H1520 mm

No. of bays	Item no. Freestanding bay	Melamine EUR	Painted EUR	Veneer EUR	Item no. Intermediate bay	Melamine EUR	Painted EUR	Veneer EUR
1	BBN2011560100070.	987,40	1.085,54	1.347,56	BBN2014560100070.	709,56	758,63	889,64
2	BBN2011560200070.	1.696,96	1.844,17	2.237,20	BBN2014560200070.	1.419,12	1.517,26	1.779,28
3	BBN2011560300070.	2.406,52	2.602,80	3.126,84	BBN2014560300070.	2.128,68	2.275,89	2.668,92
4	BBN2011560400070.	3.116,08	3.361,43	4.016,48	BBN2014560400070.	2.838,24	3.034,52	3.558,56
5	BBN2011560500070.	3.825,64	4.120,06	4.906,12	BBN2014560500070.	3.547,80	3.793,15	4.448,20
6	BBN2011560600070.	4.535,20	4.878,69	5.795,76	BBN2014560600070.	4.257,36	4.551,78	5.337,84
7	BBN2011560700070.	5.244,76	5.637,32	6.685,40	BBN2014560700070.	4.966,92	5.310,41	6.227,48
8	BBN2011560800070.	5.954,32	6.395,95	7.575,04				
9	BBN2011560900070.	6.663,88	7.154,58	8.464,68				
10	BBN2011561000070.	7.373,44	7.913,21	9.354,32				
11	BBN2011561100070.	8.083,00	8.671,84	10.243,96				
12	BBN2011561200070.	8.792,56	9.430,47	11.133,60				

H1820 mm

No. of bays	Item no. Freestanding bay	Melamine EUR	Painted EUR	Veneer EUR	Item no. Intermediate bay	Melamine EUR	Painted EUR	Veneer EUR
1	BBN2011660100070.	1.173,45	1.289,71	1.598,53	BBN2014660100070.	845,21	903,34	1.057,75
2	BBN2011660200070.	2.018,66	2.193,05	2.656,28	BBN2014660200070.	1.690,42	1.806,68	2.115,50
3	BBN2011660300070.	2.863,87	3.096,39	3.714,03	BBN2014660300070.	2.535,63	2.710,02	3.173,25
4	BBN2011660400070.	3.709,08	3.999,73	4.771,78	BBN2014660400070.	3.380,84	3.613,36	4.231,00
5	BBN2011660500070.	4.554,29	4.903,07	5.829,53	BBN2014660500070.	4.226,05	4.516,70	5.288,75
6	BBN2011660600070.	5.399,50	5.806,41	6.887,28	BBN2014660600070.	5.071,26	5.420,04	6.346,50
7	BBN2011660700070.	6.244,71	6.709,75	7.945,03	BBN2014660700070.	5.916,47	6.323,38	7.404,25
8	BBN2011660800070.	7.089,92	7.613,09	9.002,78				
9	BBN2011660900070.	7.935,13	8.516,43	10.060,53				
10	BBN2011661000070.	8.780,34	9.419,77	11.118,28				
11	BBN2011661100070.	9.625,55	10.323,11	12.176,03				
12	BBN2011661200070.	10.470,76	11.226,45	13.233,78				

H2120 mm

No. of bays	Item no. Freestanding bay	Melamine EUR	Painted EUR	Veneer EUR	Item no. Intermediate bay	Melamine EUR	Painted EUR	Veneer EUR
1	BBN2011760100070.	1.355,93	1.489,21	1.844,05	BBN2014760100070.	979,01	1.045,65	1.223,07
2	BBN2011760200070.	2.334,94	2.534,86	3.067,12	BBN2014760200070.	1.958,02	2.091,30	2.446,14
3	BBN2011760300070.	3.313,95	3.580,51	4.290,19	BBN2014760300070.	2.937,03	3.136,95	3.669,21
4	BBN2011760400070.	4.292,96	4.626,16	5.513,26	BBN2014760400070.	3.916,04	4.182,60	4.892,28
5	BBN2011760500070.	5.271,97	5.671,81	6.736,33	BBN2014760500070.	4.895,05	5.228,25	6.115,35
6	BBN2011760600070.	6.250,98	6.717,46	7.959,40	BBN2014760600070.	5.874,06	6.273,90	7.338,42
7	BBN2011760700070.	7.229,99	7.763,11	9.182,47	BBN2014760700070.	6.853,07	7.319,55	8.561,49
8	BBN2011760800070.	8.209,00	8.808,76	10.405,54				
9	BBN2011760900070.	9.188,01	9.854,41	11.628,61				
10	BBN2011761000070.	10.167,02	10.900,06	12.851,68				
11	BBN2011761100070.	11.146,03	11.945,71	14.074,75				
12	BBN2011761200070.	12.125,04	12.991,36	15.297,82				

LINGO ROUND SHELVING SYSTEM

BBN201 - 26° - LOW STEEL BACK PANEL - ADJUSTABLE FEET - FOR TOP SHELF



LINGO ROUND SHELVING SYSTEM

BBN201 - 26° - LOW STEEL BACK PANEL - ADJUSTABLE FEET - FOR TOP SHELF

Round shelving system with wooden panels and low steel back panel.

To be used with top shelves WT5 full depth and WT5 double-sided top shelf.

Freestanding bay includes 2 end wooden panels and 1 low steel back panel.

Intermediate bay includes 1 intermediate wooden panel and 1 low steel back panel.

- Prices based on steel price group 1 and wooden price group A (see Design Options pages 6-9).

- For top shelves, see from page 340

- For shelves, see from page 328

- For plinths, see page 349

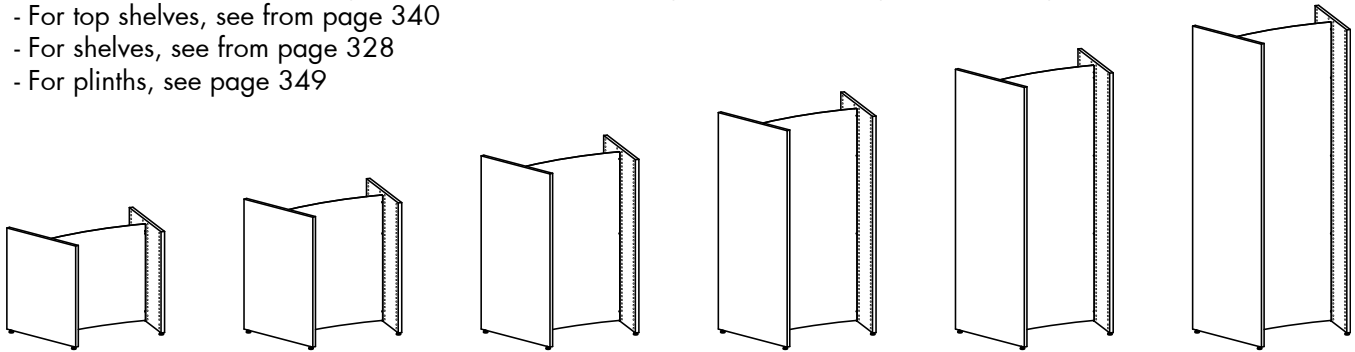

Double-sided freestanding bay - H720/920/1220/1520/1820/2120 mm

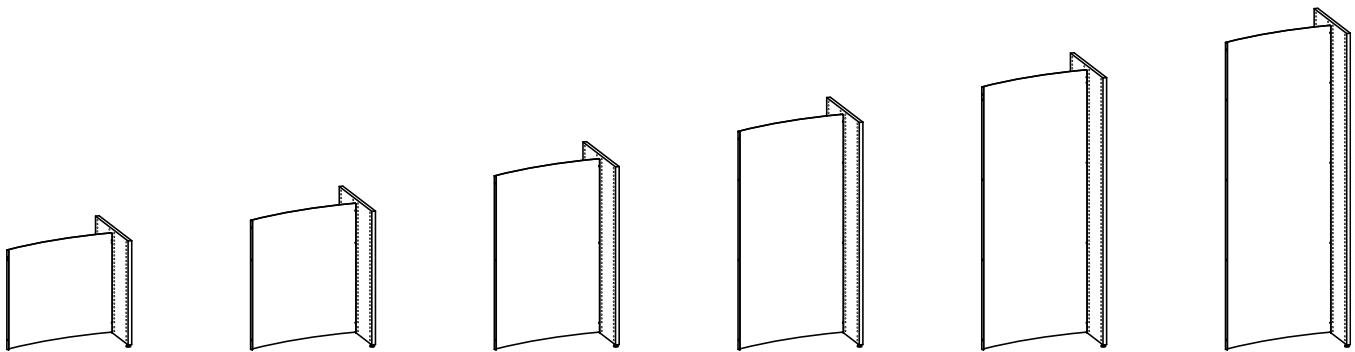

Double-sided intermediate bay - H720/920/1220/1520/1820/2120 mm

LINGO ROUND SHELVING SYSTEM

26° - LOW STEEL BACK PANEL - ADJUSTABLE FEET - FOR TOP SHELF

Painted and veneered Lingo Shelving Systems are FSC-certified.

H720 mm

No. of bays	Item no. Freestanding bay	Melamine EUR	Painted EUR	Veneer EUR	Item no. Intermediate bay	Melamine EUR	Painted EUR	Veneer EUR
1	BBN2011260100080.	522,15	578,01	751,71	BBN2014260100080.	363,35	391,28	466,16
2	BBN2011260200080.	885,50	969,29	1.217,87	BBN2014260200080.	726,70	782,56	932,32
3	BBN2011260300080.	1.248,85	1.360,57	1.684,03	BBN2014260300080.	1.090,05	1.173,84	1.398,48
4	BBN2011260400080.	1.612,20	1.751,85	2.150,19	BBN2014260400080.	1.453,40	1.565,12	1.864,64
5	BBN2011260500080.	1.975,55	2.143,13	2.616,35	BBN2014260500080.	1.816,75	1.956,40	2.330,80
6	BBN2011260600080.	2.338,90	2.534,41	3.082,51	BBN2014260600080.	2.180,10	2.347,68	2.796,96
7	BBN2011260700080.	2.702,25	2.925,69	3.548,67	BBN2014260700080.	2.543,45	2.738,96	3.263,12
8	BBN2011260800080.	3.065,60	3.316,97	4.014,83				
9	BBN2011260900080.	3.428,95	3.708,25	4.480,99				
10	BBN2011261000080.	3.792,30	4.099,53	4.947,15				
11	BBN2011261100080.	4.155,65	4.490,81	5.413,31				
12	BBN2011261200080.	4.519,00	4.882,09	5.879,47				

H920 mm

No. of bays	Item no. Freestanding bay	Melamine EUR	Painted EUR	Veneer EUR	Item no. Intermediate bay	Melamine EUR	Painted EUR	Veneer EUR
1	BBN2011360100080.	667,27	739,09	930,35	BBN2014360100080.	464,31	500,22	595,85
2	BBN2011360200080.	1.131,58	1.239,31	1.526,20	BBN2014360200080.	928,62	1.000,44	1.191,70
3	BBN2011360300080.	1.595,89	1.739,53	2.122,05	BBN2014360300080.	1.392,93	1.500,66	1.787,55
4	BBN2011360400080.	2.060,20	2.239,75	2.717,90	BBN2014360400080.	1.857,24	2.000,88	2.383,40
5	BBN2011360500080.	2.524,51	2.739,97	3.313,75	BBN2014360500080.	2.321,55	2.501,10	2.979,25
6	BBN2011360600080.	2.988,82	3.240,19	3.909,60	BBN2014360600080.	2.785,86	3.001,32	3.575,10
7	BBN2011360700080.	3.453,13	3.740,41	4.505,45	BBN2014360700080.	3.250,17	3.501,54	4.170,95
8	BBN2011360800080.	3.917,44	4.240,63	5.101,30				
9	BBN2011360900080.	4.381,75	4.740,85	5.697,15				
10	BBN2011361000080.	4.846,06	5.241,07	6.293,00				
11	BBN2011361100080.	5.310,37	5.741,29	6.888,85				
12	BBN2011361200080.	5.774,68	6.241,51	7.484,70				

H1220 mm

No. of bays	Item no. Freestanding bay	Melamine EUR	Painted EUR	Veneer EUR	Item no. Intermediate bay	Melamine EUR	Painted EUR	Veneer EUR
1	BBN2011460100080.	874,08	967,18	1.215,88	BBN2014460100080.	610,34	656,89	781,24
2	BBN2011460200080.	1.484,42	1.624,07	1.997,12	BBN2014460200080.	1.220,68	1.313,78	1.562,48
3	BBN2011460300080.	2.094,76	2.280,96	2.778,36	BBN2014460300080.	1.831,02	1.970,67	2.343,72
4	BBN2011460400080.	2.705,10	2.937,85	3.559,60	BBN2014460400080.	2.441,36	2.627,56	3.124,96
5	BBN2011460500080.	3.315,44	3.594,74	4.340,84	BBN2014460500080.	3.051,70	3.284,45	3.906,20
6	BBN2011460600080.	3.925,78	4.251,63	5.122,08	BBN2014460600080.	3.662,04	3.941,34	4.687,44
7	BBN2011460700080.	4.536,12	4.908,52	5.903,32	BBN2014460700080.	4.272,38	4.598,23	5.468,68
8	BBN2011460800080.	5.146,46	5.565,41	6.684,56				
9	BBN2011460900080.	5.756,80	6.222,30	7.465,80				
10	BBN2011461000080.	6.367,14	6.879,19	8.247,04				
11	BBN2011461100080.	6.977,48	7.536,08	9.028,28				
12	BBN2011461200080.	7.587,82	8.192,97	9.809,52				

LINGO ROUND SHELVING SYSTEM

26° - LOW STEEL BACK PANEL - ADJUSTABLE FEET - FOR TOP SHELF

Painted and veneered Lingo Shelving Systems are FSC-certified.

H1520 mm

No. of bays	Item no. Freestanding bay	Melamine EUR	Painted EUR	Veneer EUR	Item no. Intermediate bay	Melamine EUR	Painted EUR	Veneer EUR
1	BBN2011560100080.	987,40	1.085,54	1.347,56	BBN2014560100080.	709,56	758,63	889,64
2	BBN2011560200080.	1.696,96	1.844,17	2.237,20	BBN2014560200080.	1.419,12	1.517,26	1.779,28
3	BBN2011560300080.	2.406,52	2.602,80	3.126,84	BBN2014560300080.	2.128,68	2.275,89	2.668,92
4	BBN2011560400080.	3.116,08	3.361,43	4.016,48	BBN2014560400080.	2.838,24	3.034,52	3.558,56
5	BBN2011560500080.	3.825,64	4.120,06	4.906,12	BBN2014560500080.	3.547,80	3.793,15	4.448,20
6	BBN2011560600080.	4.535,20	4.878,69	5.795,76	BBN2014560600080.	4.257,36	4.551,78	5.337,84
7	BBN2011560700080.	5.244,76	5.637,32	6.685,40	BBN2014560700080.	4.966,92	5.310,41	6.227,48
8	BBN2011560800080.	5.954,32	6.395,95	7.575,04				
9	BBN2011560900080.	6.663,88	7.154,58	8.464,68				
10	BBN2011561000080.	7.373,44	7.913,21	9.354,32				
11	BBN2011561100080.	8.083,00	8.671,84	10.243,96				
12	BBN2011561200080.	8.792,56	9.430,47	11.133,60				

H1820 mm

No. of bays	Item no. Freestanding bay	Melamine EUR	Painted EUR	Veneer EUR	Item no. Intermediate bay	Melamine EUR	Painted EUR	Veneer EUR
1	BBN2011660100080.	1.173,45	1.289,71	1.598,53	BBN2014660100080.	845,21	903,34	1.057,75
2	BBN2011660200080.	2.018,66	2.193,05	2.656,28	BBN2014660200080.	1.690,42	1.806,68	2.115,50
3	BBN2011660300080.	2.863,87	3.096,39	3.714,03	BBN2014660300080.	2.535,63	2.710,02	3.173,25
4	BBN2011660400080.	3.709,08	3.999,73	4.771,78	BBN2014660400080.	3.380,84	3.613,36	4.231,00
5	BBN2011660500080.	4.554,29	4.903,07	5.829,53	BBN2014660500080.	4.226,05	4.516,70	5.288,75
6	BBN2011660600080.	5.399,50	5.806,41	6.887,28	BBN2014660600080.	5.071,26	5.420,04	6.346,50
7	BBN2011660700080.	6.244,71	6.709,75	7.945,03	BBN2014660700080.	5.916,47	6.323,38	7.404,25
8	BBN2011660800080.	7.089,92	7.613,09	9.002,78				
9	BBN2011660900080.	7.935,13	8.516,43	10.060,53				
10	BBN2011661000080.	8.780,34	9.419,77	11.118,28				
11	BBN2011661100080.	9.625,55	10.323,11	12.176,03				
12	BBN2011661200080.	10.470,76	11.226,45	13.233,78				

H2120 mm

No. of bays	Item no. Freestanding bay	Melamine EUR	Painted EUR	Veneer EUR	Item no. Intermediate bay	Melamine EUR	Painted EUR	Veneer EUR
1	BBN2011760100080.	1.355,93	1.489,21	1.844,05	BBN2014760100080.	979,01	1.045,65	1.223,07
2	BBN2011760200080.	2.334,94	2.534,86	3.067,12	BBN2014760200080.	1.958,02	2.091,30	2.446,14
3	BBN2011760300080.	3.313,95	3.580,51	4.290,19	BBN2014760300080.	2.937,03	3.136,95	3.669,21
4	BBN2011760400080.	4.292,96	4.626,16	5.513,26	BBN2014760400080.	3.916,04	4.182,60	4.892,28
5	BBN2011760500080.	5.271,97	5.671,81	6.736,33	BBN2014760500080.	4.895,05	5.228,25	6.115,35
6	BBN2011760600080.	6.250,98	6.717,46	7.959,40	BBN2014760600080.	5.874,06	6.273,90	7.338,42
7	BBN2011760700080.	7.229,99	7.763,11	9.182,47	BBN2014760700080.	6.853,07	7.319,55	8.561,49
8	BBN2011760800080.	8.209,00	8.808,76	10.405,54				
9	BBN2011760900080.	9.188,01	9.854,41	11.628,61				
10	BBN2011761000080.	10.167,02	10.900,06	12.851,68				
11	BBN2011761100080.	11.146,03	11.945,71	14.074,75				
12	BBN2011761200080.	12.125,04	12.991,36	15.297,82				

LINGO ROUND SHELVING SYSTEM

BBN202 - 26° - STEEL BACK FRAME - ADJUSTABLE FEET - WITH TOP PLATE



LINGO ROUND SHELVING SYSTEM

BBN202 - 26° - STEEL BACK FRAME - ADJUSTABLE FEET - WITH TOP PLATE

Round shelving system with wooden end panels, intermediate panels, steel back frame and overlaying top plate. See further description on starter, intermediate and end sections on pages 26-27.

- Prices based on steel price group 1 and wooden price group A (see Design Options pages 6-9).
- For shelves, see from page 328
- For end panel bays, see page 378
- For plinths, see page 349

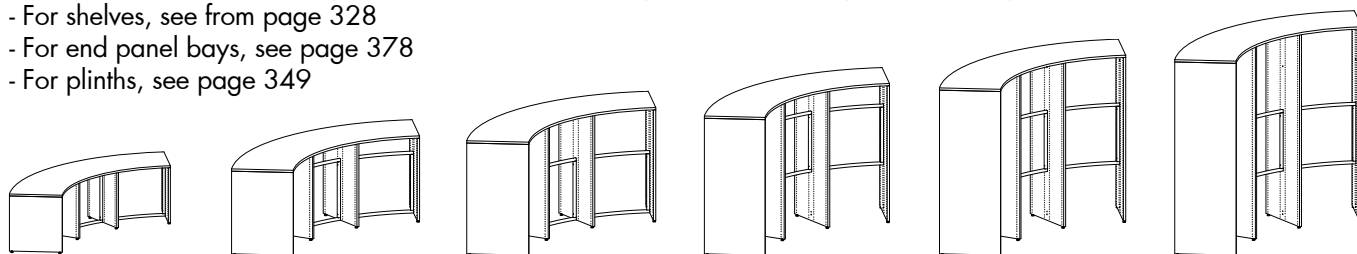

Freestanding 26° double-sided bays - H720/920/1220/1520/1820/2120 mm

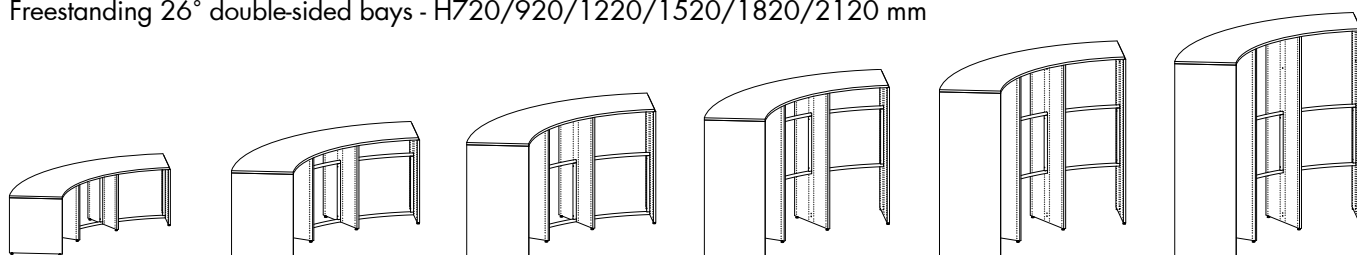

Left starter 26° double-sided bays - H720/920/1220/1520/1820/2120 mm

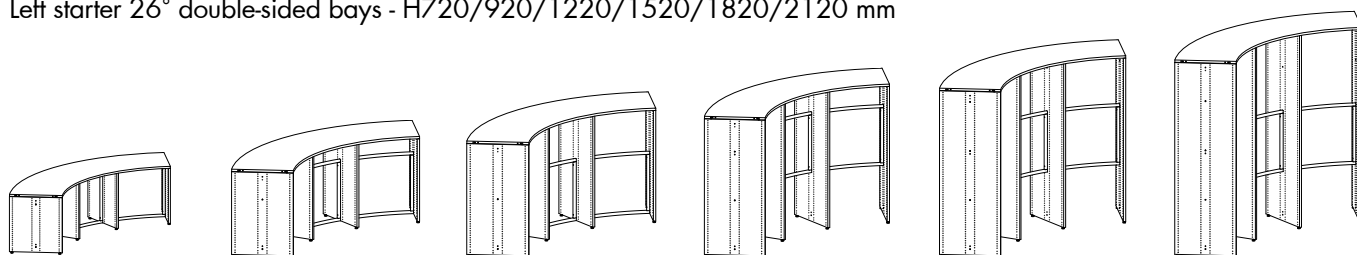

Right starter 26° double-sided bays - H720/920/1220/1520/1820/2120 mm

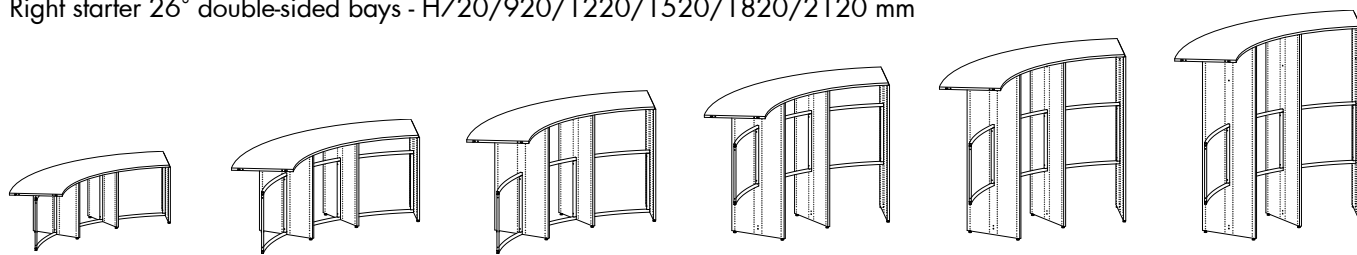

Intermediate 26° double-sided bays - H720/920/1220/1520/1820/2120 mm

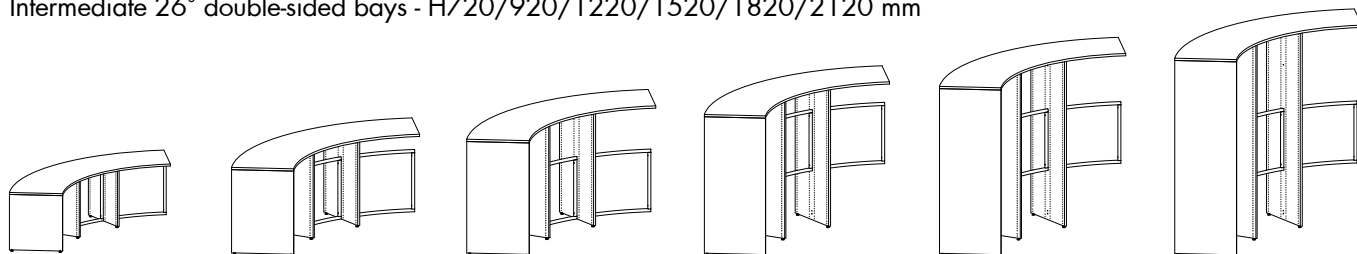

Left end 26° double-sided bays - H720/920/1220/1520/1820/2120 mm

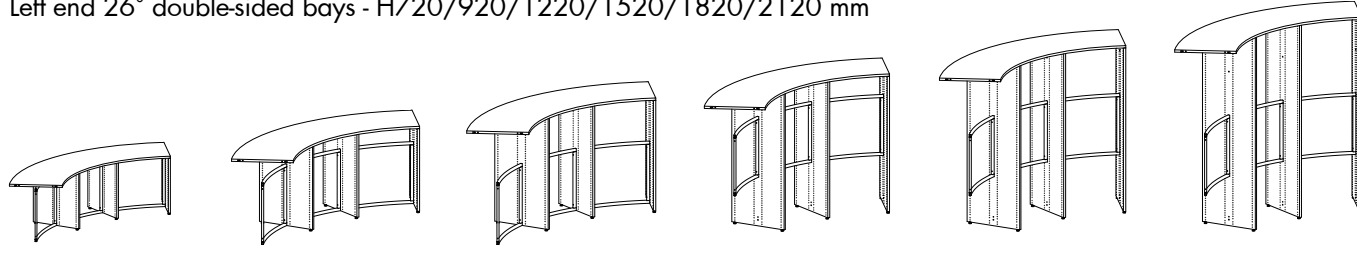

Right end 26° double-sided bays - H720/920/1220/1520/1820/2120 mm

LINGO ROUND SHELVING SYSTEM

26° - STEEL BACK FRAME - ADJUSTABLE FEET - WITH TOP PLATE - FREESTANDING SECTION

Painted and veneered Lingo Shelving Systems are FSC-certified.

H720 mm

No. of bays	Item no.	Melamine EUR	Painted EUR	Veneer EUR
1	BBN2021260110060.	1.092,72	1.237,16	1.623,53
2	BBN2021260210060.	2.148,21	2.430,70	3.185,48
3	BBN2021260310060.	3.332,04	3.775,20	4.958,90

H920 mm

No. of bays	Item no.	Melamine EUR	Painted EUR	Veneer EUR
1	BBN2021360110060.	1.181,04	1.341,44	1.769,31
2	BBN2021360210060.	2.280,69	2.587,12	3.404,15
3	BBN2021360310060.	3.508,68	3.983,76	5.250,46

H1220 mm

No. of bays	Item no.	Melamine EUR	Painted EUR	Veneer EUR
1	BBN2021460110060.	1.302,60	1.484,28	1.969,59
2	BBN2021460210060.	2.463,03	2.801,38	3.704,57
3	BBN2021460310060.	3.751,80	4.269,44	5.651,02

H1520 mm

No. of bays	Item no.	Melamine EUR	Painted EUR	Veneer EUR
1	BBN2021560110060.	1.330,80	1.517,52	2.016,15
2	BBN2021560210060.	2.505,33	2.851,24	3.774,41
3	BBN2021560310060.	3.808,20	4.335,92	5.744,14

H1820 mm

No. of bays	Item no.	Melamine EUR	Painted EUR	Veneer EUR
1	BBN2021660110060.	1.431,60	1.636,44	2.181,87
2	BBN2021660210060.	2.656,53	3.029,62	4.022,99
3	BBN2021660310060.	4.009,80	4.573,76	6.075,58

H2120 mm

No. of bays	Item no.	Melamine EUR	Painted EUR	Veneer EUR
1	BBN2021760110060.	1.528,96	1.750,82	2.342,27
2	BBN2021760210060.	2.802,57	3.201,19	4.263,59
3	BBN2021760310060.	4.204,52	4.802,52	6.396,38

LINGO ROUND SHELVING SYSTEM

26° - STEEL BACK FRAME - ADJUSTABLE FEET - WITH TOP PLATE - LEFT STARTER SECTION

Painted and veneered Lingo Shelving Systems are FSC-certified.

H720 mm

No. of bays	Item no.	Melamine EUR	Painted EUR	Veneer EUR
1	BBN2022260110060.	1.091,13	1.235,30	1.620,74
2	BBN2022260210060.	2.147,01	2.429,51	3.183,62
3	BBN2022260310060.	3.330,98	3.774,13	4.957,44

H920 mm

No. of bays	Item no.	Melamine EUR	Painted EUR	Veneer EUR
1	BBN2022360110060.	1.179,45	1.339,58	1.766,52
2	BBN2022360210060.	2.279,49	2.585,93	3.402,29
3	BBN2022360310060.	3.507,62	3.982,69	5.249,00

H1220 mm

No. of bays	Item no.	Melamine EUR	Painted EUR	Veneer EUR
1	BBN2022460110060.	1.301,01	1.482,42	1.966,80
2	BBN2022460210060.	2.461,83	2.800,19	3.702,71
3	BBN2022460310060.	3.750,74	4.268,37	5.649,56

H1520 mm

No. of bays	Item no.	Melamine EUR	Painted EUR	Veneer EUR
1	BBN2022560110060.	1.329,21	1.515,66	2.013,36
2	BBN2022560210060.	2.504,13	2.850,05	3.772,55
3	BBN2022560310060.	3.807,14	4.334,85	5.742,68

H1820 mm

No. of bays	Item no.	Melamine EUR	Painted EUR	Veneer EUR
1	BBN2022660110060.	1.430,01	1.634,58	2.179,08
2	BBN2022660210060.	2.655,33	3.028,43	4.021,13
3	BBN2022660310060.	4.008,74	4.572,69	6.074,12

H2120 mm

No. of bays	Item no.	Melamine EUR	Painted EUR	Veneer EUR
1	BBN2022760110060.	1.527,37	1.748,96	2.339,48
2	BBN2022760210060.	2.801,37	3.200,00	4.261,73
3	BBN2022760310060.	4.203,46	4.801,45	6.394,92

LINGO ROUND SHELVING SYSTEM

26° - STEEL BACK FRAME - ADJUSTABLE FEET - WITH TOP PLATE - RIGHT STARTER SECTION

Painted and veneered Lingo Shelving Systems are FSC-certified.

H720 mm

No. of bays	Item no.	Melamine EUR	Painted EUR	Veneer EUR
1	BBN2023260110060.	1.091,13	1.235,30	1.620,74
2	BBN2023260210060.	2.147,01	2.429,51	3.183,62
3	BBN2023260310060.	3.330,98	3.774,13	4.957,44

H920 mm

No. of bays	Item no.	Melamine EUR	Painted EUR	Veneer EUR
1	BBN2023360110060.	1.179,45	1.339,58	1.766,52
2	BBN2023360210060.	2.279,49	2.585,93	3.402,29
3	BBN2023360310060.	3.507,62	3.982,69	5.249,00

H1220 mm

No. of bays	Item no.	Melamine EUR	Painted EUR	Veneer EUR
1	BBN2023460110060.	1.301,01	1.482,42	1.966,80
2	BBN2023460210060.	2.461,83	2.800,19	3.702,71
3	BBN2023460310060.	3.750,74	4.268,37	5.649,56

H1520 mm

No. of bays	Item no.	Melamine EUR	Painted EUR	Veneer EUR
1	BBN2023560110060.	1.329,21	1.515,66	2.013,36
2	BBN2023560210060.	2.504,13	2.850,05	3.772,55
3	BBN2023560310060.	3.807,14	4.334,85	5.742,68

H1820 mm

No. of bays	Item no.	Melamine EUR	Painted EUR	Veneer EUR
1	BBN2023660110060.	1.430,01	1.634,58	2.179,08
2	BBN2023660210060.	2.655,33	3.028,43	4.021,13
3	BBN2023660310060.	4.008,74	4.572,69	6.074,12

H2120 mm

No. of bays	Item no.	Melamine EUR	Painted EUR	Veneer EUR
1	BBN2023760110060.	1.527,37	1.748,96	2.339,48
2	BBN2023760210060.	2.801,37	3.200,00	4.261,73
3	BBN2023760310060.	4.203,46	4.801,45	6.394,92

LINGO ROUND SHELVING SYSTEM

26° - STEEL BACK FRAME - ADJUSTABLE FEET - WITH TOP PLATE - INTERMEDIATE SECTION

Painted and veneered Lingo Shelving Systems are FSC-certified.

H720 mm

No. of bays	Item no.	Melamine EUR	Painted EUR	Veneer EUR
1	BBN2024260110060.	927,81	1.043,25	1.351,68
2	BBN2024260210060.	1.967,47	2.218,17	2.887,69
3	BBN2024260310060.	3.156,75	3.569,05	4.670,03

H920 mm

No. of bays	Item no.	Melamine EUR	Painted EUR	Veneer EUR
1	BBN2024360110060.	971,97	1.095,39	1.424,57
2	BBN2024360210060.	2.055,79	2.322,45	3.033,47
3	BBN2024360310060.	3.289,23	3.725,47	4.888,70

H1220 mm

No. of bays	Item no.	Melamine EUR	Painted EUR	Veneer EUR
1	BBN2024460110060.	1.032,75	1.166,81	1.524,71
2	BBN2024460210060.	2.177,35	2.465,29	3.233,75
3	BBN2024460310060.	3.471,57	3.939,73	5.189,12

H1520 mm

No. of bays	Item no.	Melamine EUR	Painted EUR	Veneer EUR
1	BBN2024560110060.	1.046,85	1.183,43	1.547,99
2	BBN2024560210060.	2.205,55	2.498,53	3.280,31
3	BBN2024560310060.	3.513,87	3.989,59	5.258,96

H1820 mm

No. of bays	Item no.	Melamine EUR	Painted EUR	Veneer EUR
1	BBN2024660110060.	1.097,25	1.242,89	1.630,85
2	BBN2024660210060.	2.306,35	2.617,45	3.446,03
3	BBN2024660310060.	3.665,07	4.167,97	5.507,54

H2120 mm

No. of bays	Item no.	Melamine EUR	Painted EUR	Veneer EUR
1	BBN2024760110060.	1.145,93	1.300,08	1.711,05
2	BBN2024760210060.	2.403,71	2.731,83	3.606,43
3	BBN2024760310060.	3.811,11	4.339,54	5.748,14

LINGO ROUND SHELVING SYSTEM

26° - STEEL BACK FRAME - ADJUSTABLE FEET - WITH TOP PLATE - LEFT END SECTION

Painted and veneered Lingo Shelving Systems are FSC-certified.

H720 mm

No. of bays	Item no.	Melamine EUR	Painted EUR	Veneer EUR
1	BBN2025260110060.	932,33	1.048,57	1.359,13
2	BBN2025260210060.	1.988,21	2.242,78	2.922,01
3	BBN2025260310060.	3.172,18	3.587,40	4.695,83

H920 mm

No. of bays	Item no.	Melamine EUR	Painted EUR	Veneer EUR
1	BBN2025360110060.	976,49	1.100,71	1.432,02
2	BBN2025360210060.	2.076,53	2.347,06	3.067,79
3	BBN2025360310060.	3.304,66	3.743,82	4.914,50

H1220 mm

No. of bays	Item no.	Melamine EUR	Painted EUR	Veneer EUR
1	BBN2025460110060.	1.037,27	1.172,13	1.532,16
2	BBN2025460210060.	2.198,09	2.489,90	3.268,07
3	BBN2025460310060.	3.487,00	3.958,08	5.214,92

H1520 mm

No. of bays	Item no.	Melamine EUR	Painted EUR	Veneer EUR
1	BBN2025560110060.	1.051,37	1.188,75	1.555,44
2	BBN2025560210060.	2.226,29	2.523,14	3.314,63
3	BBN2025560310060.	3.529,30	4.007,94	5.284,76

H1820 mm

No. of bays	Item no.	Melamine EUR	Painted EUR	Veneer EUR
1	BBN2025660110060.	1.101,77	1.248,21	1.638,30
2	BBN2025660210060.	2.327,09	2.642,06	3.480,35
3	BBN2025660310060.	3.680,50	4.186,32	5.533,34

H2120 mm

No. of bays	Item no.	Melamine EUR	Painted EUR	Veneer EUR
1	BBN2025760110060.	1.150,45	1.305,40	1.718,50
2	BBN2025760210060.	2.424,45	2.756,44	3.640,75
3	BBN2025760310060.	3.826,54	4.357,89	5.773,94

LINGO ROUND SHELVING SYSTEM

26° - STEEL BACK FRAME - ADJUSTABLE FEET - WITH TOP PLATE - RIGHT END SECTION

Painted and veneered Lingo Shelving Systems are FSC-certified.

H720 mm

No. of bays	Item no.	Melamine EUR	Painted EUR	Veneer EUR
1	BBN2026260110060.	932,33	1.048,57	1.359,13
2	BBN2026260210060.	1.988,21	2.242,78	2.922,01
3	BBN2026260310060.	3.172,18	3.587,40	4.695,83

H920 mm

No. of bays	Item no.	Melamine EUR	Painted EUR	Veneer EUR
1	BBN2026360110060.	976,49	1.100,71	1.432,02
2	BBN2026360210060.	2.076,53	2.347,06	3.067,79
3	BBN2026360310060.	3.304,66	3.743,82	4.914,50

H1220 mm

No. of bays	Item no.	Melamine EUR	Painted EUR	Veneer EUR
1	BBN2026460110060.	1.037,27	1.172,13	1.532,16
2	BBN2026460210060.	2.198,09	2.489,90	3.268,07
3	BBN2026460310060.	3.487,00	3.958,08	5.214,92

H1520 mm

No. of bays	Item no.	Melamine EUR	Painted EUR	Veneer EUR
1	BBN2026560110060.	1.051,37	1.188,75	1.555,44
2	BBN2026560210060.	2.226,29	2.523,14	3.314,63
3	BBN2026560310060.	3.529,30	4.007,94	5.284,76

H1820 mm

No. of bays	Item no.	Melamine EUR	Painted EUR	Veneer EUR
1	BBN2026660110060.	1.101,77	1.248,21	1.638,30
2	BBN2026660210060.	2.327,09	2.642,06	3.480,35
3	BBN2026660310060.	3.680,50	4.186,32	5.533,34

H2120 mm

No. of bays	Item no.	Melamine EUR	Painted EUR	Veneer EUR
1	BBN2026760110060.	1.150,45	1.305,40	1.718,50
2	BBN2026760210060.	2.424,45	2.756,44	3.640,75
3	BBN2026760310060.	3.826,54	4.357,89	5.773,94

LINGO ROUND SHELVING SYSTEM

BBN202 - 26° - STEEL BACK PANEL - ADJUSTABLE FEET - WITH TOP PLATE



LINGO ROUND SHELVING SYSTEM

BBN202 - 26° - STEEL BACK PANEL - ADJUSTABLE FEET - WITH TOP PLATE

Round shelving system with wooden end panels, intermediate panels, steel back panel and overlaying top plate.
See further description on starter, intermediate and end sections on pages 26-27.

- Prices based on steel price group 1 and wooden price group A (see Design Options pages 6-9).
- For shelves, see from page 328
- For castor frame, see page 347

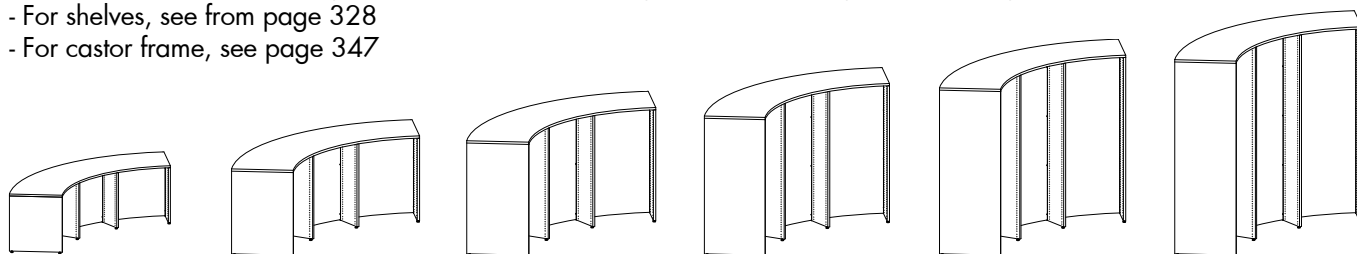

Freestanding 26° double-sided bays - H720/920/1220/1520/1820/2120 mm

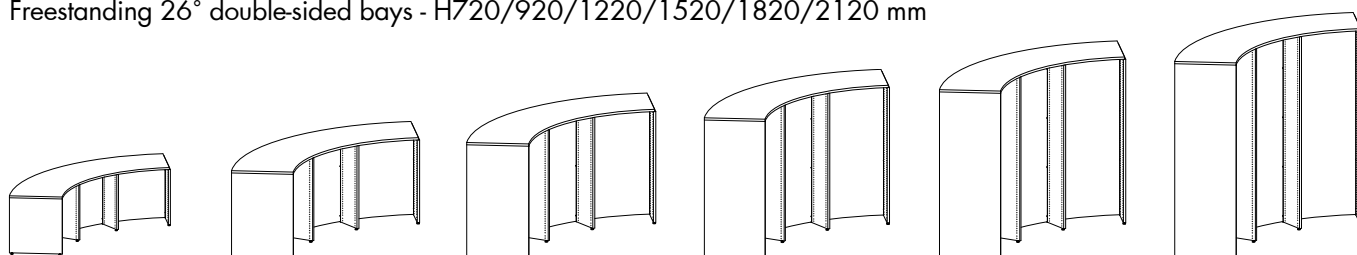

Left starter 26° double-sided bays - H720/920/1220/1520/1820/2120 mm

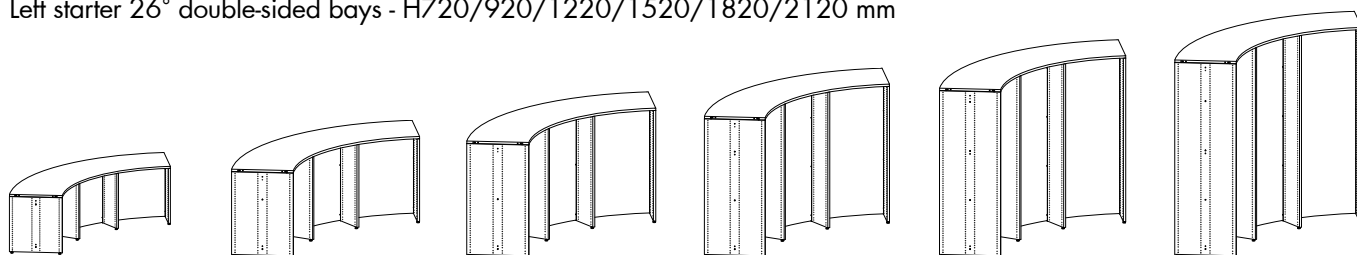

Right starter 26° double-sided bays - H720/920/1220/1520/1820/2120 mm

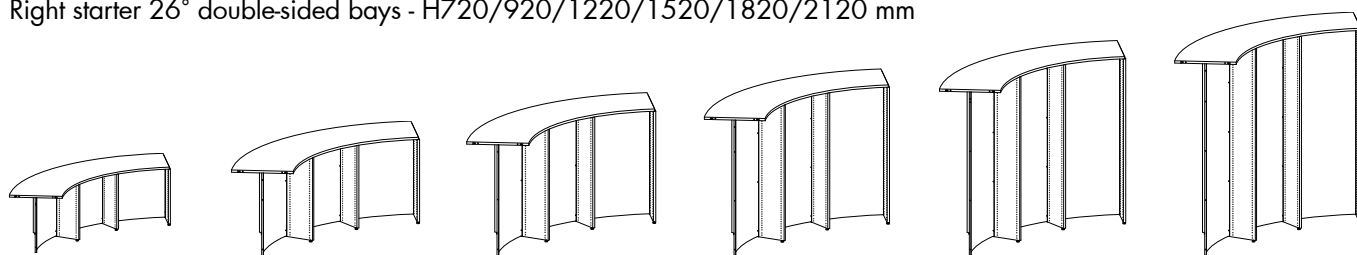

Intermediate 18° double-sided bays - H720/920/1220/1520/1820/2120 mm

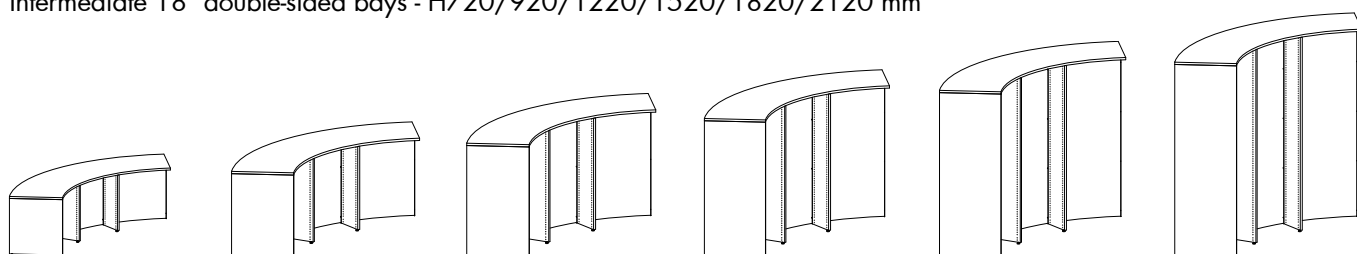

Left end 26° double-sided bays - H720/920/1220/1520/1820/2120 mm

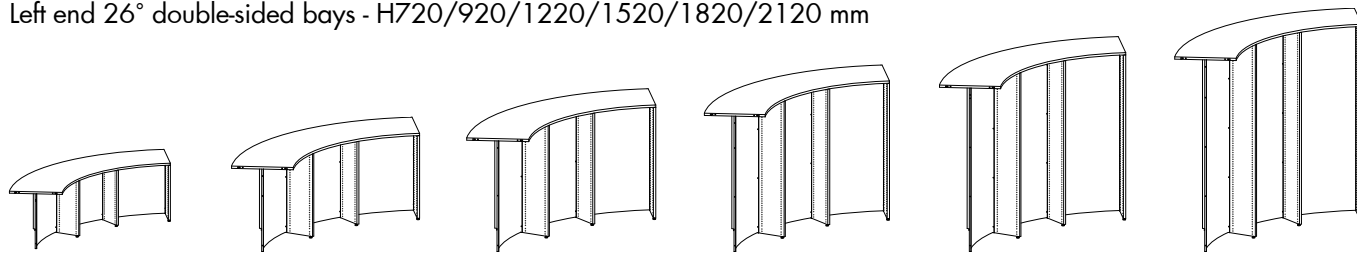

Right end 26° double-sided bays - H720/920/1220/1520/1820/2120 mm

LINGO ROUND SHELVING SYSTEM

26° - STEEL BACK PANEL - ADJUSTABLE FEET - WITH TOP PLATE - FREESTANDING SECTION

Painted and veneered Lingo Shelving Systems are FSC-certified.

H720 mm

No. of bays	Item no.	Melamine EUR	Painted EUR	Veneer EUR
1	BBN2021260110080.	1.024,62	1.169,06	1.555,43
2	BBN2021260210080.	2.012,01	2.294,50	3.049,28
3	BBN2021260310080.	3.127,74	3.570,90	4.754,60

H920 mm

No. of bays	Item no.	Melamine EUR	Painted EUR	Veneer EUR
1	BBN2021360110080.	1.169,74	1.330,14	1.758,01
2	BBN2021360210080.	2.258,09	2.564,52	3.381,55
3	BBN2021360310080.	3.474,78	3.949,86	5.216,56

H1220 mm

No. of bays	Item no.	Melamine EUR	Painted EUR	Veneer EUR
1	BBN2021460110080.	1.376,55	1.558,23	2.043,54
2	BBN2021460210080.	2.610,93	2.949,28	3.852,47
3	BBN2021460310080.	3.973,65	4.491,29	5.872,87

H1520 mm

No. of bays	Item no.	Melamine EUR	Painted EUR	Veneer EUR
1	BBN2021560110080.	1.489,87	1.676,59	2.175,22
2	BBN2021560210080.	2.823,47	3.169,38	4.092,55
3	BBN2021560310080.	4.285,41	4.813,13	6.221,35

H1820 mm

No. of bays	Item no.	Melamine EUR	Painted EUR	Veneer EUR
1	BBN2021660110080.	1.675,92	1.880,76	2.426,19
2	BBN2021660210080.	3.145,17	3.518,26	4.511,63
3	BBN2021660310080.	4.742,76	5.306,72	6.808,54

H2120 mm

No. of bays	Item no.	Melamine EUR	Painted EUR	Veneer EUR
1	BBN2021760110080.	1.858,40	2.080,26	2.671,71
2	BBN2021760210080.	3.461,45	3.860,07	4.922,47
3	BBN2021760310080.	5.192,84	5.790,84	7.384,70

LINGO ROUND SHELVING SYSTEM

26° - STEEL BACK PANEL - ADJUSTABLE FEET - WITH TOP PLATE - LEFT STARTER SECTION

Painted and veneered Lingo Shelving Systems are FSC-certified.

H720 mm

No. of bays	Item no.	Melamine EUR	Painted EUR	Veneer EUR
1	BBN2022260110080.	1.023,03	1.167,20	1.552,64
2	BBN2022260210080.	2.010,81	2.293,31	3.047,42
3	BBN2022260310080.	3.126,68	3.569,83	4.753,14

H920 mm

No. of bays	Item no.	Melamine EUR	Painted EUR	Veneer EUR
1	BBN2022360110080.	1.168,15	1.328,28	1.755,22
2	BBN2022360210080.	2.256,89	2.563,33	3.379,69
3	BBN2022360310080.	3.473,72	3.948,79	5.215,10

H1220 mm

No. of bays	Item no.	Melamine EUR	Painted EUR	Veneer EUR
1	BBN2022460110080.	1.374,96	1.556,37	2.040,75
2	BBN2022460210080.	2.609,73	2.948,09	3.850,61
3	BBN2022460310080.	3.972,59	4.490,22	5.871,41

H1520 mm

No. of bays	Item no.	Melamine EUR	Painted EUR	Veneer EUR
1	BBN2022560110080.	1.488,28	1.674,73	2.172,43
2	BBN2022560210080.	2.822,27	3.168,19	4.090,69
3	BBN2022560310080.	4.284,35	4.812,06	6.219,89

H1820 mm

No. of bays	Item no.	Melamine EUR	Painted EUR	Veneer EUR
1	BBN2022660110080.	1.674,33	1.878,90	2.423,40
2	BBN2022660210080.	3.143,97	3.517,07	4.509,77
3	BBN2022660310080.	4.741,70	5.305,65	6.807,08

H2120 mm

No. of bays	Item no.	Melamine EUR	Painted EUR	Veneer EUR
1	BBN2022760110080.	1.856,81	2.078,40	2.668,92
2	BBN2022760210080.	3.460,25	3.858,88	4.920,61
3	BBN2022760310080.	5.191,78	5.789,77	7.383,24

LINGO ROUND SHELVING SYSTEM

26° - STEEL BACK PANEL - ADJUSTABLE FEET - WITH TOP PLATE - RIGHT STARTER SECTION

Painted and veneered Lingo Shelving Systems are FSC-certified.

H720 mm

No. of bays	Item no.	Melamine EUR	Painted EUR	Veneer EUR
1	BBN2023260110080.	1.023,03	1.167,20	1.552,64
2	BBN2023260210080.	2.010,81	2.293,31	3.047,42
3	BBN2023260310080.	3.126,68	3.569,83	4.753,14

H920 mm

No. of bays	Item no.	Melamine EUR	Painted EUR	Veneer EUR
1	BBN2023360110080.	1.168,15	1.328,28	1.755,22
2	BBN2023360210080.	2.256,89	2.563,33	3.379,69
3	BBN2023360310080.	3.473,72	3.948,79	5.215,10

H1220 mm

No. of bays	Item no.	Melamine EUR	Painted EUR	Veneer EUR
1	BBN2023460110080.	1.374,96	1.556,37	2.040,75
2	BBN2023460210080.	2.609,73	2.948,09	3.850,61
3	BBN2023460310080.	3.972,59	4.490,22	5.871,41

H1520 mm

No. of bays	Item no.	Melamine EUR	Painted EUR	Veneer EUR
1	BBN2023560110080.	1.488,28	1.674,73	2.172,43
2	BBN2023560210080.	2.822,27	3.168,19	4.090,69
3	BBN2023560310080.	4.284,35	4.812,06	6.219,89

H1820 mm

No. of bays	Item no.	Melamine EUR	Painted EUR	Veneer EUR
1	BBN2023660110080.	1.674,33	1.878,90	2.423,40
2	BBN2023660210080.	3.143,97	3.517,07	4.509,77
3	BBN2023660310080.	4.741,70	5.305,65	6.807,08

H2120 mm

No. of bays	Item no.	Melamine EUR	Painted EUR	Veneer EUR
1	BBN2023760110080.	1.856,81	2.078,40	2.668,92
2	BBN2023760210080.	3.460,25	3.858,88	4.920,61
3	BBN2023760310080.	5.191,78	5.789,77	7.383,24

LINGO ROUND SHELVING SYSTEM

26° - STEEL BACK PANEL - ADJUSTABLE FEET - WITH TOP PLATE - INTERMEDIATE SECTION

Painted and veneered Lingo Shelving Systems are FSC-certified.

H720 mm

No. of bays	Item no.	Melamine EUR	Painted EUR	Veneer EUR
1	BBN2024260110080.	859,71	975,15	1.283,58
2	BBN2024260210080.	1.831,27	2.081,97	2.751,49
3	BBN2024260310080.	2.952,45	3.364,75	4.465,73

H920 mm

No. of bays	Item no.	Melamine EUR	Painted EUR	Veneer EUR
1	BBN2024360110080.	960,67	1.084,09	1.413,27
2	BBN2024360210080.	2.033,19	2.299,85	3.010,87
3	BBN2024360310080.	3.255,33	3.691,57	4.854,80

H1220 mm

No. of bays	Item no.	Melamine EUR	Painted EUR	Veneer EUR
1	BBN2024460110080.	1.106,70	1.240,76	1.598,66
2	BBN2024460210080.	2.325,25	2.613,19	3.381,65
3	BBN2024460310080.	3.693,42	4.161,58	5.410,97

H1520 mm

No. of bays	Item no.	Melamine EUR	Painted EUR	Veneer EUR
1	BBN2024560110080.	1.205,92	1.342,50	1.707,06
2	BBN2024560210080.	2.523,69	2.816,67	3.598,45
3	BBN2024560310080.	3.991,08	4.466,80	5.736,17

H1820 mm

No. of bays	Item no.	Melamine EUR	Painted EUR	Veneer EUR
1	BBN2024660110080.	1.341,57	1.487,21	1.875,17
2	BBN2024660210080.	2.794,99	3.106,09	3.934,67
3	BBN2024660310080.	4.398,03	4.900,93	6.240,50

H2120 mm

No. of bays	Item no.	Melamine EUR	Painted EUR	Veneer EUR
1	BBN2024760110080.	1.475,37	1.629,52	2.040,49
2	BBN2024760210080.	3.062,59	3.390,71	4.265,31
3	BBN2024760310080.	4.799,43	5.327,86	6.736,46

LINGO ROUND SHELVING SYSTEM

26° - STEEL BACK PANEL - ADJUSTABLE FEET - WITH TOP PLATE - LEFT END SECTION

Painted and veneered Lingo Shelving Systems are FSC-certified.

H720 mm

No. of bays	Item no.	Melamine EUR	Painted EUR	Veneer EUR
1	BBN2025260110080.	864,23	980,47	1.291,03
2	BBN2025260210080.	1.852,01	2.106,58	2.785,81
3	BBN2025260310080.	2.967,88	3.383,10	4.491,53

H920 mm

No. of bays	Item no.	Melamine EUR	Painted EUR	Veneer EUR
1	BBN2025360110080.	965,19	1.089,41	1.420,72
2	BBN2025360210080.	2.053,93	2.324,46	3.045,19
3	BBN2025360310080.	3.270,76	3.709,92	4.880,60

H1220 mm

No. of bays	Item no.	Melamine EUR	Painted EUR	Veneer EUR
1	BBN2025460110080.	1.111,22	1.246,08	1.606,11
2	BBN2025460210080.	2.345,99	2.637,80	3.415,97
3	BBN2025460310080.	3.708,85	4.179,93	5.436,77

H1520 mm

No. of bays	Item no.	Melamine EUR	Painted EUR	Veneer EUR
1	BBN2025560110080.	1.210,44	1.347,82	1.714,51
2	BBN2025560210080.	2.544,43	2.841,28	3.632,77
3	BBN2025560310080.	4.006,51	4.485,15	5.761,97

H1820 mm

No. of bays	Item no.	Melamine EUR	Painted EUR	Veneer EUR
1	BBN2025660110080.	1.346,09	1.492,53	1.882,62
2	BBN2025660210080.	2.815,73	3.130,70	3.968,99
3	BBN2025660310080.	4.413,46	4.919,28	6.266,30

H2120 mm

No. of bays	Item no.	Melamine EUR	Painted EUR	Veneer EUR
1	BBN2025760110080.	1.479,89	1.634,84	2.047,94
2	BBN2025760210080.	3.083,33	3.415,32	4.299,63
3	BBN2025760310080.	4.814,86	5.346,21	6.762,26

LINGO ROUND SHELVING SYSTEM

26° - STEEL BACK PANEL - ADJUSTABLE FEET - WITH TOP PLATE - RIGHT END SECTION

Painted and veneered Lingo Shelving Systems are FSC-certified.

H720 mm

No. of bays	Item no.	Melamine EUR	Painted EUR	Veneer EUR
1	BBN2026260110080.	864,23	980,47	1.291,03
2	BBN2026260210080.	1.852,01	2.106,58	2.785,81
3	BBN2026260310080.	2.967,88	3.383,10	4.491,53

H920 mm

No. of bays	Item no.	Melamine EUR	Painted EUR	Veneer EUR
1	BBN2026360110080.	965,19	1.089,41	1.420,72
2	BBN2026360210080.	2.053,93	2.324,46	3.045,19
3	BBN2026360310080.	3.270,76	3.709,92	4.880,60

H1220 mm

No. of bays	Item no.	Melamine EUR	Painted EUR	Veneer EUR
1	BBN2026460110080.	1.111,22	1.246,08	1.606,11
2	BBN2026460210080.	2.345,99	2.637,80	3.415,97
3	BBN2026460310080.	3.708,85	4.179,93	5.436,77

H1520 mm

No. of bays	Item no.	Melamine EUR	Painted EUR	Veneer EUR
1	BBN2026560110080.	1.210,44	1.347,82	1.714,51
2	BBN2026560210080.	2.544,43	2.841,28	3.632,77
3	BBN2026560310080.	4.006,51	4.485,15	5.761,97

H1820 mm

No. of bays	Item no.	Melamine EUR	Painted EUR	Veneer EUR
1	BBN2026660110080.	1.346,09	1.492,53	1.882,62
2	BBN2026660210080.	2.815,73	3.130,70	3.968,99
3	BBN2026660310080.	4.413,46	4.919,28	6.266,30

H2120 mm

No. of bays	Item no.	Melamine EUR	Painted EUR	Veneer EUR
1	BBN2026760110080.	1.479,89	1.634,84	2.047,94
2	BBN2026760210080.	3.083,33	3.415,32	4.299,63
3	BBN2026760310080.	4.814,86	5.346,21	6.762,26

LINGO ROUND SHELVING SYSTEM

BBN211 - 26° - STEEL BACK FRAME - CASTOR PLATE - FOR TOP SHELF



LINGO ROUND SHELVING SYSTEM

BBN211 - 26° - STEEL BACK FRAME - CASTOR PLATE - FOR TOP SHELF

Round shelving system with wooden panels, steel back frame and castor plate. To be used with top shelf.

- Prices based on steel price group 1 and wooden price group A (see Design Options pages 6-9).
- For top shelves, see from page 340
- For shelves, see from page 328

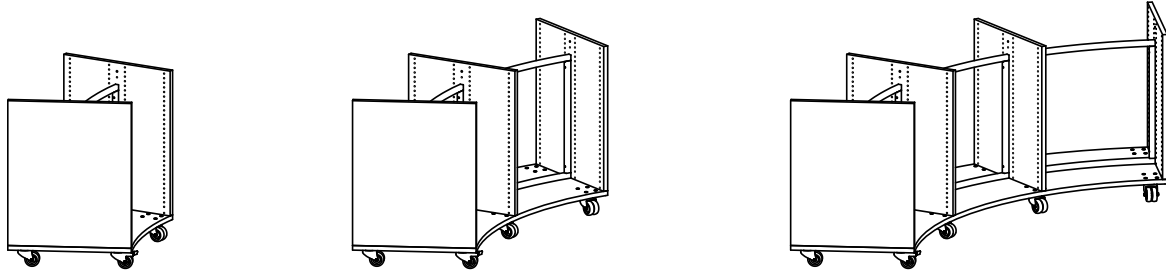

Double-sided H920 mm - 1/2/3 bays

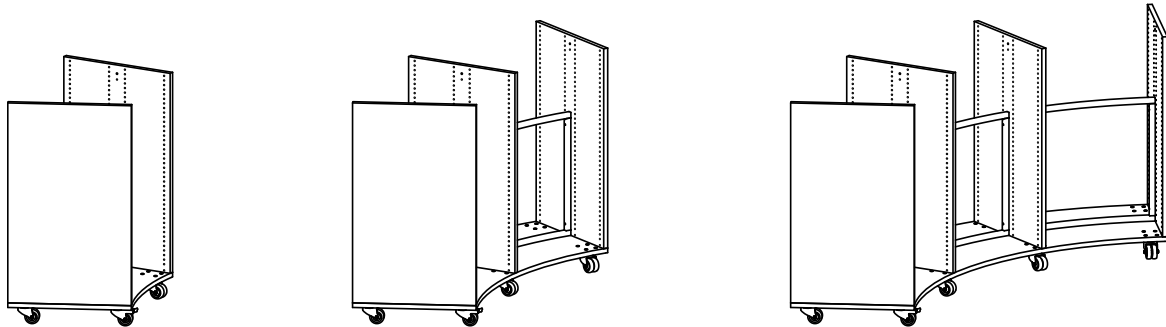

Double-sided H1220 mm - 1/2/3 bays

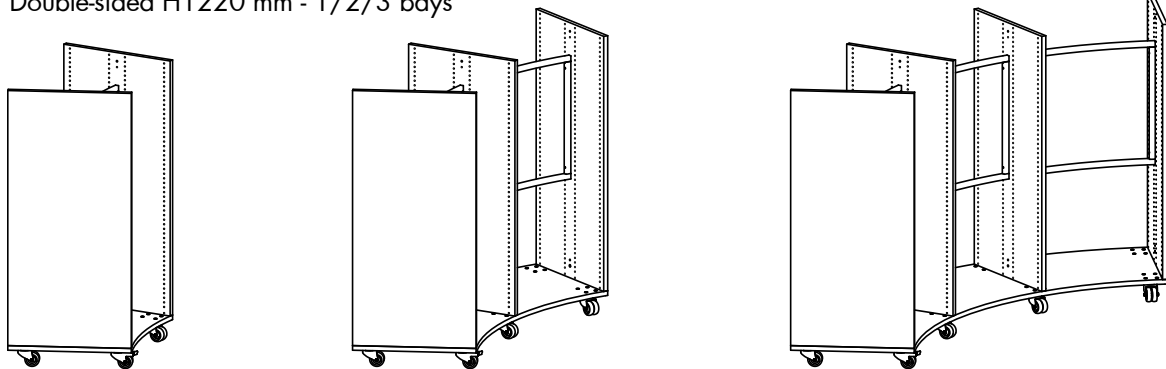

Double-sided H1520 mm - 1/2/3 bays

LINGO ROUND SHELVING SYSTEM

26° - STEEL BACK FRAME - CASTOR PLATE - FOR TOP SHELF

Painted and veneered Lingo Shelving Systems are FSC-certified.

H920 mm

No. of bays	Item no.	Melamine EUR	Painted EUR	Veneer EUR
1	BBN211136010006.	1.410,20	1.611,17	2.146,76
2	BBN211136020006.	2.587,65	2.948,35	3.909,82
3	BBN211136030006.	3.712,70	4.223,82	5.586,42

H1220 mm

No. of bays	Item no.	Melamine EUR	Painted EUR	Veneer EUR
1	BBN211146010006.	1.531,76	1.754,01	2.347,04
2	BBN211146020006.	2.769,99	3.162,61	4.210,24
3	BBN211146030006.	3.955,82	4.509,50	5.986,98

H1520 mm

No. of bays	Item no.	Melamine EUR	Painted EUR	Veneer EUR
1	BBN211156010006.	1.559,96	1.787,25	2.393,60
2	BBN211156020006.	2.812,29	3.212,47	4.280,08
3	BBN211156030006.	4.012,22	4.575,98	6.080,10

LINGO ROUND SHELVING SYSTEM

26° - STEEL BACK FRAME - CASTOR PLATE - FOR TOP SHELF

LINGO ROUND SHELVING SYSTEM

BBN211 - 26° - HIGH STEEL BACK PANEL - CASTOR PLATE - FOR TOP SHELF



LINGO ROUND SHELVING SYSTEM

BBN211 - 26° - HIGH STEEL BACK PANEL - CASTOR PLATE - FOR TOP SHELF

Round shelving system with wooden panels, high steel back panel and castor plate.
To be used with top shelves WT5 standard depth top shelf.

- Prices based on steel price group 1 and wooden price group A (see Design Options pages 6-9).
- For top shelves, see from page 340
- For shelves, see from page 328

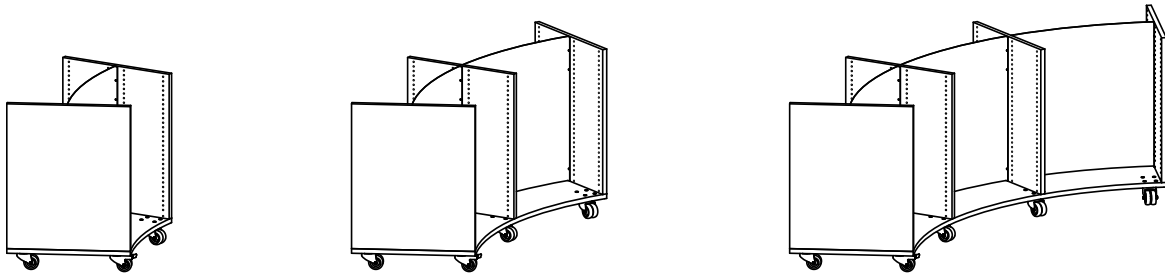

Double-sided H920 mm - 1/2/3 bays

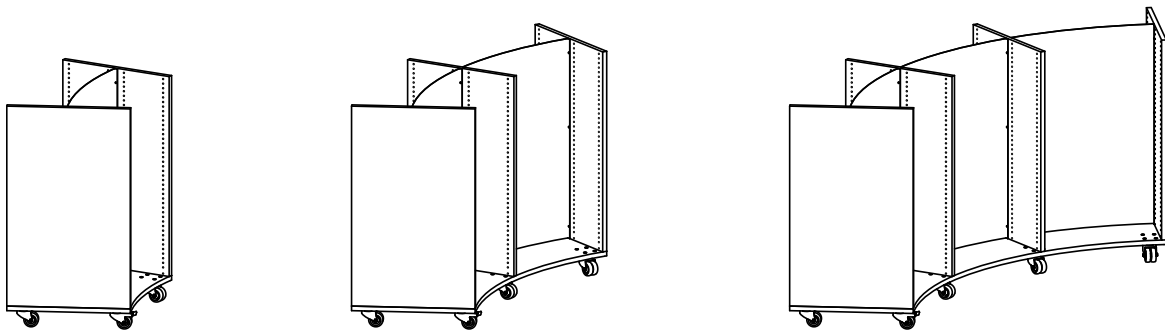

Double-sided H1220 mm - 1/2/3 bays

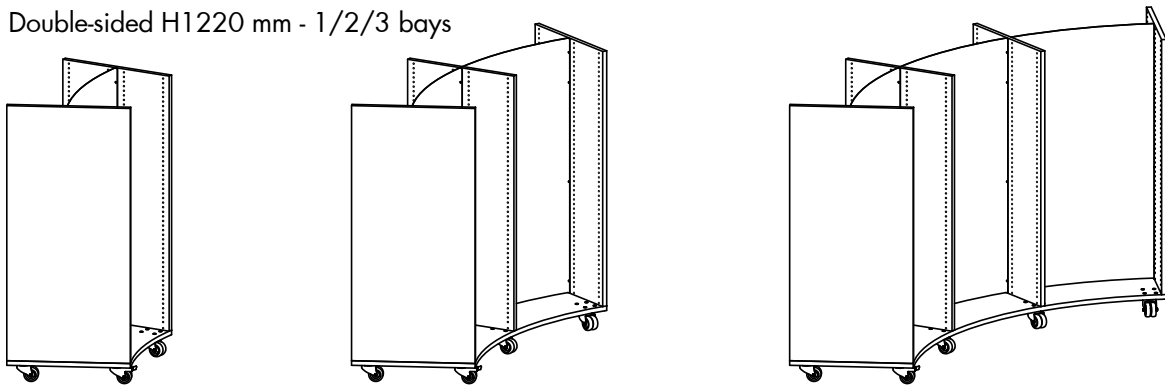

Double-sided H1520 mm - 1/2/3 bays

LINGO ROUND SHELVING SYSTEM

26° - HIGH STEEL BACK PANEL - CASTOR PLATE - FOR TOP SHELF

Painted and veneered Lingo Shelving Systems are FSC-certified.

H920 mm

No. of bays	Item no.	Melamine EUR	Painted EUR	Veneer EUR
1	BBN211136010008.	1.398,90	1.599,87	2.135,46
2	BBN211136020008.	2.565,05	2.925,75	3.887,22
3	BBN211136030008.	3.678,80	4.189,92	5.552,52

H1220 mm

No. of bays	Item no.	Melamine EUR	Painted EUR	Veneer EUR
1	BBN211146010008.	1.605,71	1.827,96	2.420,99
2	BBN211146020008.	2.917,89	3.310,51	4.358,14
3	BBN211146030008.	4.177,67	4.731,35	6.208,83

H1520 mm

No. of bays	Item no.	Melamine EUR	Painted EUR	Veneer EUR
1	BBN211156010008.	1.719,03	1.946,32	2.552,67
2	BBN211156020008.	3.130,43	3.530,61	4.598,22
3	BBN211156030008.	4.489,43	5.053,19	6.557,31

LINGO ROUND SHELVING SYSTEM

26° - HIGH STEEL BACK PANEL - CASTOR PLATE - FOR TOP SHELF

LINGO ROUND SHELVING SYSTEM

BBN211 - 26° - LOW STEEL BACK PANEL - CASTOR PLATE - FOR TOP SHELF



LINGO ROUND SHELVING SYSTEM

BBN211 - 26° - LOW STEEL BACK PANEL - CASTOR PLATE - FOR TOP SHELF

Round shelving system with wooden panels, low steel back panel and castor plate.
To be used with top shelves WT5 full depth and WT5 double-sided top shelf.

- Prices based on steel price group 1 and wooden price group A (see Design Options pages 6-9).
- For top shelves, see from page 340
- For shelves, see from page 328
- For slat panels, see from page 351 (note slate panel replaces outer panel)

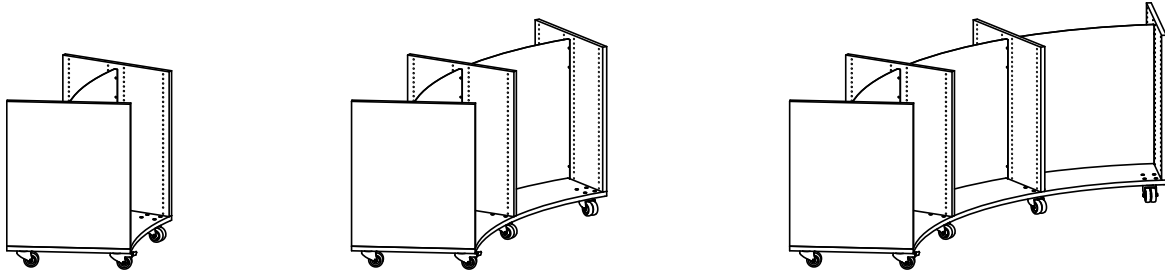

Double-sided H920 mm - 1/2/3 bays

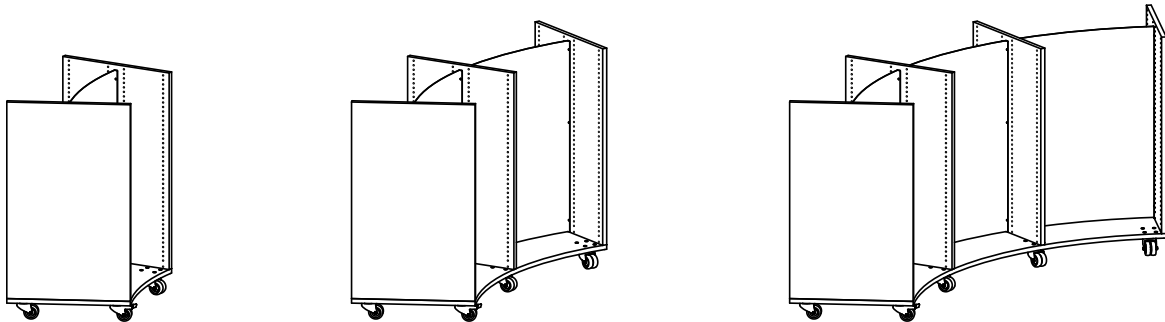

Double-sided H1220 mm - 1/2/3 bays

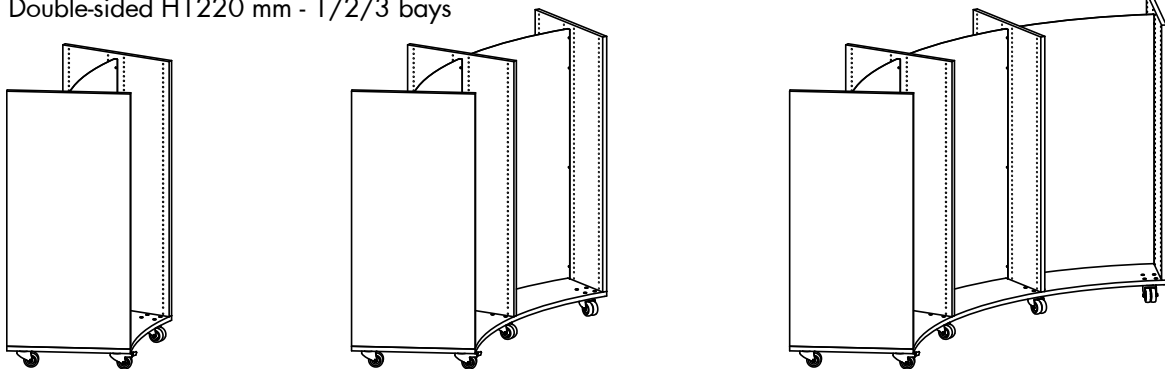

Double-sided H1520 mm - 1/2/3 bays

LINGO ROUND SHELVING SYSTEM

26° - LOW STEEL BACK PANEL - CASTOR PLATE - FOR TOP SHELF

Painted and veneered Lingo Shelving Systems are FSC-certified.

H920 mm

No. of bays	Item no.	Melamine EUR	Painted EUR	Veneer EUR
1	BBN211136010007.	1.398,90	1.599,87	2.135,46
2	BBN211136020007.	2.565,05	2.925,75	3.887,22
3	BBN211136030007.	3.678,80	4.189,92	5.552,52

H1220 mm

No. of bays	Item no.	Melamine EUR	Painted EUR	Veneer EUR
1	BBN211146010007.	1.605,71	1.827,96	2.420,99
2	BBN211146020007.	2.917,89	3.310,51	4.358,14
3	BBN211146030007.	4.177,67	4.731,35	6.208,83

H1520 mm

No. of bays	Item no.	Melamine EUR	Painted EUR	Veneer EUR
1	BBN211156010007.	1.719,03	1.946,32	2.552,67
2	BBN211156020007.	3.130,43	3.530,61	4.598,22
3	BBN211156030007.	4.489,43	5.053,19	6.557,31

LINGO ROUND SHELVING SYSTEM

26° - LOW STEEL BACK PANEL - CASTOR PLATE - FOR TOP SHELF

LINGO ROUND SHELVING SYSTEM

BBN212 - 26° - STEEL BACK FRAME - CASTOR PLATE - WITH OVERLAYING TOP PLATE



LINGO ROUND SHELVING SYSTEM

BBN212 - 26° - STEEL BACK FRAME - CASTOR PLATE - WITH OVERLAYING TOP PLATE

Round shelving system with wooden panels, steel back frame, castor plate and overlaying top plate.

- Prices based on steel price group 1 and wooden price group A (see Design Options pages 6-9).
- For shelves, see from page 328

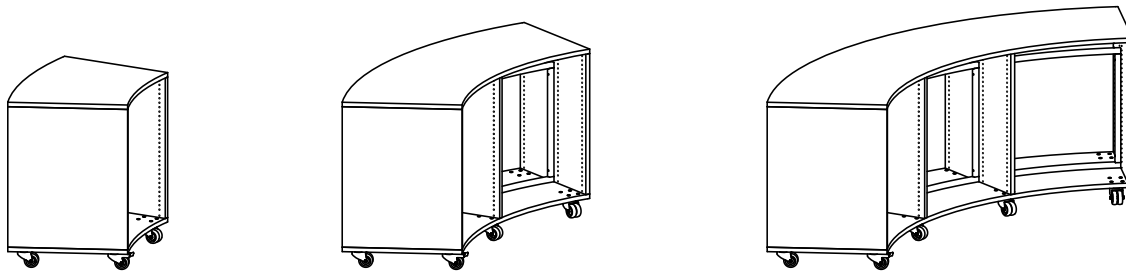

Double-sided H920 mm - 1/2/3 bays

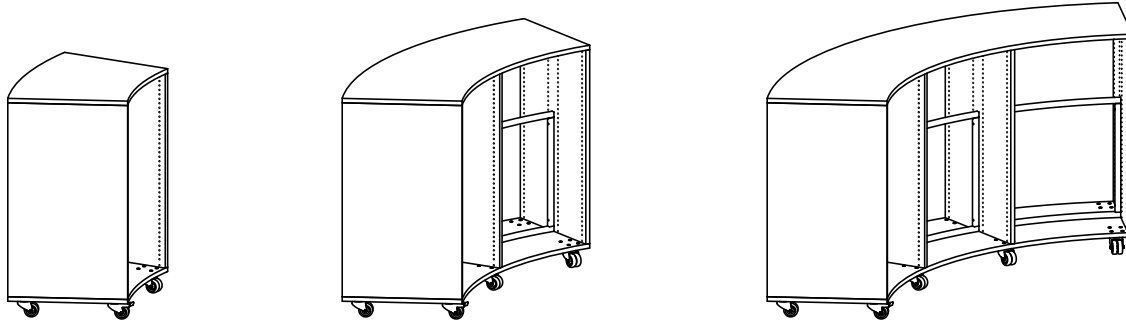

Double-sided H1220 mm - 1/2/3 bays

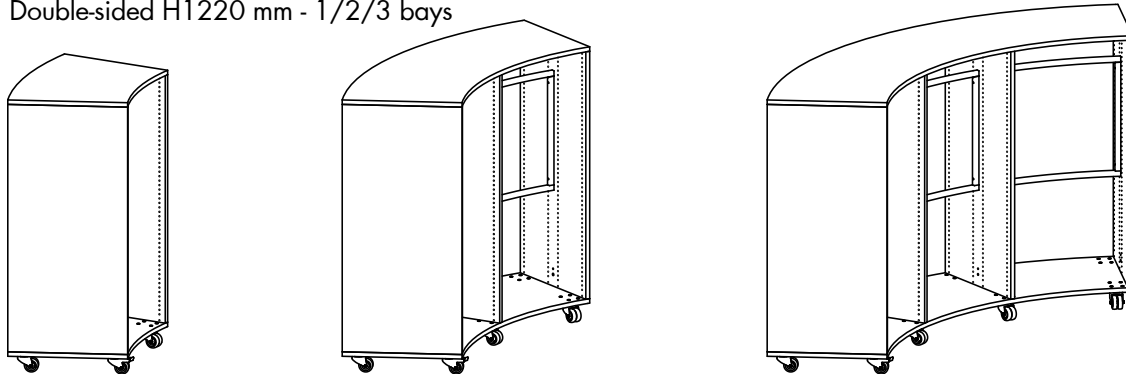

Double-sided H1520 mm - 1/2/3 bays

LINGO ROUND SHELVING SYSTEM

26° - STEEL BACK FRAME - CASTOR PLATE - WITH OVERLAYING TOP PLATE

Painted and veneered Lingo Shelving Systems are FSC-certified.

H920 mm

No. of bays	Item no.	Melamine EUR	Painted EUR	Veneer EUR
1	BBN212136011006.	1.912,67	2.202,22	2.974,42
2	BBN212136021006.	3.714,16	4.273,56	5.765,17
3	BBN212136031006.	5.591,59	6.434,15	8.680,93

H1220 mm

No. of bays	Item no.	Melamine EUR	Painted EUR	Veneer EUR
1	BBN212146011006.	2.034,23	2.345,06	3.174,70
2	BBN212146021006.	3.896,50	4.487,82	6.065,59
3	BBN212146031006.	5.834,71	6.719,83	9.081,49

H1520 mm

No. of bays	Item no.	Melamine EUR	Painted EUR	Veneer EUR
1	BBN212156011006.	2.062,43	2.378,30	3.221,26
2	BBN212156021006.	3.938,80	4.537,68	6.135,43
3	BBN212156031006.	5.891,11	6.786,31	9.174,61

LINGO ROUND SHELVING SYSTEM

26° - STEEL BACK FRAME - CASTOR PLATE - WITH OVERLAYING TOP PLATE

LINGO ROUND SHELVING SYSTEM

BBN212 - 26° - STEEL BACK PANEL - CASTOR PLATE - WITH OVERLAYING TOP PLATE



LINGO ROUND SHELVING SYSTEM

BBN212 - 26° - STEEL BACK PANEL - CASTOR PLATE - WITH OVERLAYING TOP PLATE

Round shelving system with wooden panels, steel back panel, castor plate and overlaying top plate.

- Prices based on steel price group 1 and wooden price group A (see Design Options pages 6-9).
- For shelves, see from page 328

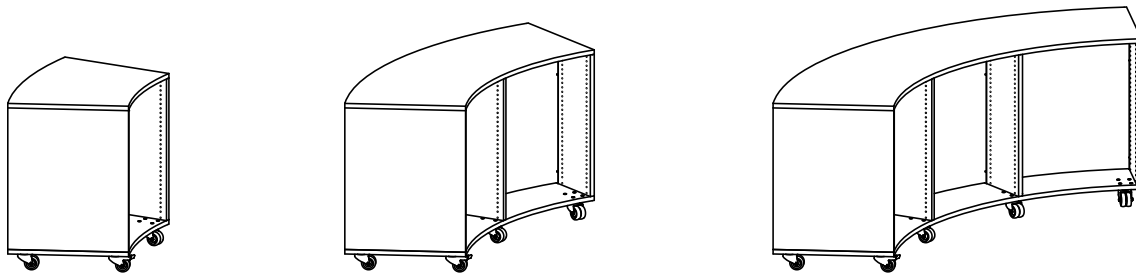

Double-sided H920 mm - 1/2/3 bays

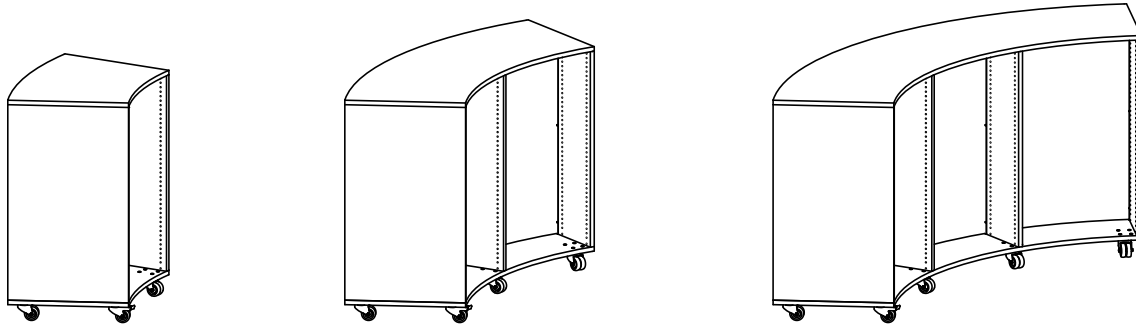

Double-sided H1220 mm - 1/2/3 bays

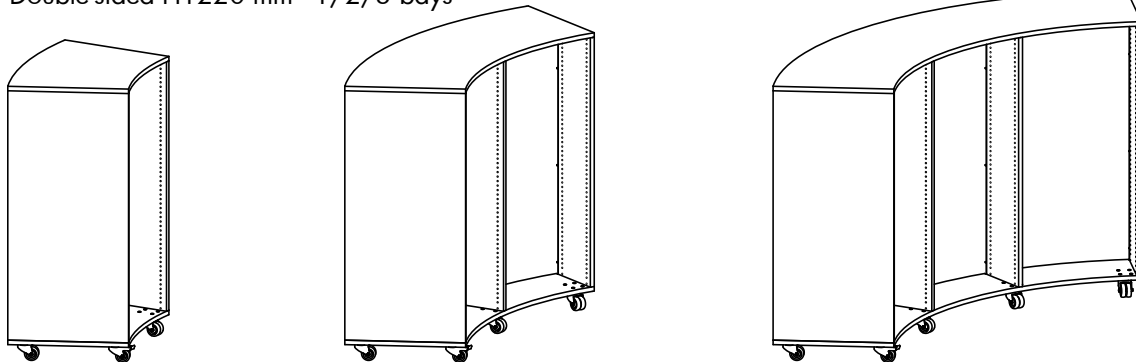

Double-sided H1520 mm - 1/2/3 bays

LINGO ROUND SHELVING SYSTEM

26° - STEEL BACK PANEL - CASTOR PLATE - WITH OVERLAYING TOP PLATE

Painted and veneered Lingo Shelving Systems are FSC-certified.

H920 mm

No. of bays	Item no.	Melamine EUR	Painted EUR	Veneer EUR
1	BBN212136011008.	1.901,37	2.190,92	2.963,12
2	BBN212136021008.	3.691,56	4.250,96	5.742,57
3	BBN212136031008.	5.557,69	6.400,25	8.647,03

H1220 mm

No. of bays	Item no.	Melamine EUR	Painted EUR	Veneer EUR
1	BBN212146011008.	2.108,18	2.419,01	3.248,65
2	BBN212146021008.	4.044,40	4.635,72	6.213,49
3	BBN212146031008.	6.056,56	6.941,68	9.303,34

H1520 mm

No. of bays	Item no.	Melamine EUR	Painted EUR	Veneer EUR
1	BBN212156011008.	2.221,50	2.537,37	3.380,33
2	BBN212156021008.	4.256,94	4.855,82	6.453,57
3	BBN212156031008.	6.368,32	7.263,52	9.651,82

LINGO ROUND SHELVING SYSTEM

26° - STEEL BACK PANEL - CASTOR PLATE - WITH OVERLAYING TOP PLATE

LINGO ROUND SHELVING SYSTEM

BBN221 - 18° - STEEL BACK FRAME - ADJUSTABLE FEET - FOR TOP SHELF



LINGO ROUND SHELVING SYSTEM

BBN221 - 18° - STEEL BACK FRAME - ADJUSTABLE FEET - FOR TOP SHELF

Round shelving system with wooden panels and steel back frame. To be used with top shelf.
Freestanding bay includes 2 end wooden panels and 1 or 2 steel back frame depending on height.
Intermediate bay includes 1 intermediate wooden panel and 1 steel back frame.

- Prices based on steel price group 1 and wooden price group A (see Design Options pages 6-9).
- For top shelves, see from page 340
- For shelves, see from page 328

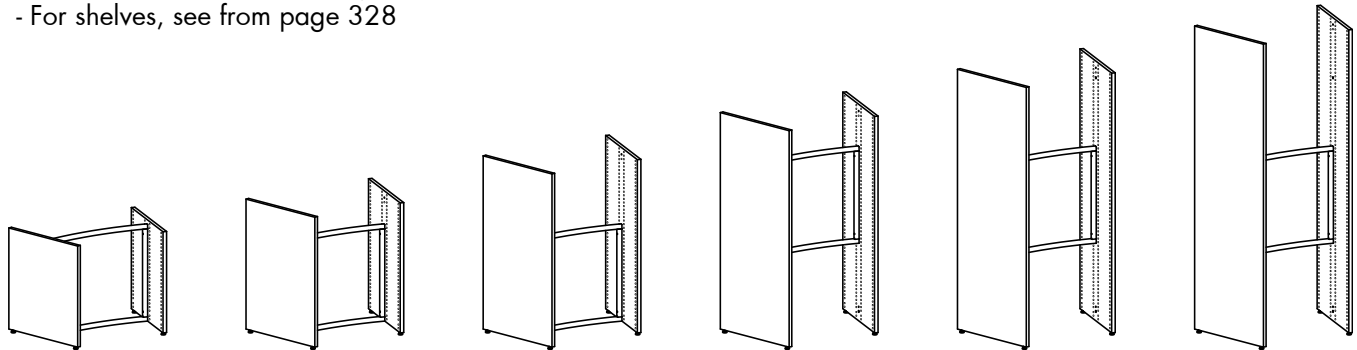

Double-sided freestanding bay - H720/920/1220/1520/1820/2120 mm

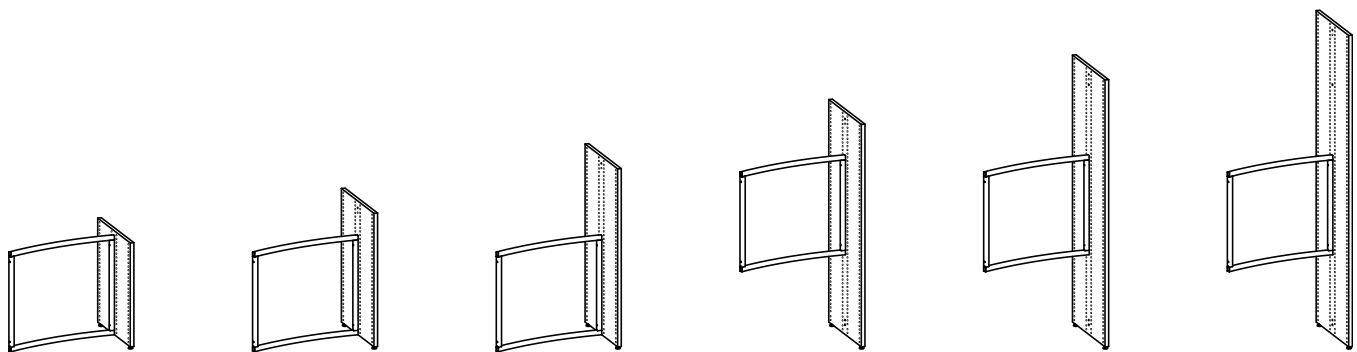

Double-sided intermediate bay - H720/920/1220/1520/1820/2120 mm

LINGO ROUND SHELVING SYSTEM

18° - STEEL BACK FRAME - ADJUSTABLE FEET - FOR TOP SHELF

Painted and veneered Lingo Shelving Systems are FSC-certified.

H720 mm

No. of bays	Item no. Freestanding bay	Melamine EUR	Painted EUR	Veneer EUR	Item no. Intermediate bay	Melamine EUR	Painted EUR	Veneer EUR
1	BBN2211260100060.	590,25	646,11	819,81	BBN2214260100060.	431,45	459,38	534,26
2	BBN2211260200060.	1.021,70	1.105,49	1.354,07	BBN2214260200060.	862,90	918,76	1.068,52
3	BBN2211260300060.	1.453,15	1.564,87	1.888,33	BBN2214260300060.	1.294,35	1.378,14	1.602,78
4	BBN2211260400060.	1.884,60	2.024,25	2.422,59	BBN2214260400060.	1.725,80	1.837,52	2.137,04
5	BBN2211260500060.	2.316,05	2.483,63	2.956,85	BBN2214260500060.	2.157,25	2.296,90	2.671,30
6	BBN2211260600060.	2.747,50	2.943,01	3.491,11	BBN2214260600060.	2.588,70	2.756,28	3.205,56
7	BBN2211260700060.	3.178,95	3.402,39	4.025,37	BBN2214260700060.	3.020,15	3.215,66	3.739,82
8	BBN2211260800060.	3.610,40	3.861,77	4.559,63	BBN2214260800060.	3.451,60	3.675,04	4.274,08
9	BBN2211260900060.	4.041,85	4.321,15	5.093,89	BBN2214260900060.	3.883,05	4.134,42	4.808,34
10	BBN2211261000060.	4.473,30	4.780,53	5.628,15	BBN2214261000060.	4.314,50	4.593,80	5.342,60
11	BBN2211261100060.	4.904,75	5.239,91	6.162,41				
12	BBN2211261200060.	5.336,20	5.699,29	6.696,67				
13	BBN2211261300060.	5.767,65	6.158,67	7.230,93				
14	BBN2211261400060.	6.199,10	6.618,05	7.765,19				
15	BBN2211261500060.	6.630,55	7.077,43	8.299,45				
16	BBN2211261600060.	7.062,00	7.536,81	8.833,71				
17	BBN2211261700060.	7.493,45	7.996,19	9.367,97				
18	BBN2211261800060.	7.924,90	8.455,57	9.902,23				

H920 mm

No. of bays	Item no. Freestanding bay	Melamine EUR	Painted EUR	Veneer EUR	Item no. Intermediate bay	Melamine EUR	Painted EUR	Veneer EUR
1	BBN2211360100060.	678,57	750,39	941,65	BBN2214360100060.	475,61	511,52	607,15
2	BBN2211360200060.	1.154,18	1.261,91	1.548,80	BBN2214360200060.	951,22	1.023,04	1.214,30
3	BBN2211360300060.	1.629,79	1.773,43	2.155,95	BBN2214360300060.	1.426,83	1.534,56	1.821,45
4	BBN2211360400060.	2.105,40	2.284,95	2.763,10	BBN2214360400060.	1.902,44	2.046,08	2.428,60
5	BBN2211360500060.	2.581,01	2.796,47	3.370,25	BBN2214360500060.	2.378,05	2.557,60	3.035,75
6	BBN2211360600060.	3.056,62	3.307,99	3.977,40	BBN2214360600060.	2.853,66	3.069,12	3.642,90
7	BBN2211360700060.	3.532,23	3.819,51	4.584,55	BBN2214360700060.	3.329,27	3.580,64	4.250,05
8	BBN2211360800060.	4.007,84	4.331,03	5.191,70	BBN2214360800060.	3.804,88	4.092,16	4.857,20
9	BBN2211360900060.	4.483,45	4.842,55	5.798,85	BBN2214360900060.	4.280,49	4.603,68	5.464,35
10	BBN2211361000060.	4.959,06	5.354,07	6.406,00	BBN2214361000060.	4.756,10	5.115,20	6.071,50
11	BBN2211361100060.	5.434,67	5.865,59	7.013,15				
12	BBN2211361200060.	5.910,28	6.377,11	7.620,30				
13	BBN2211361300060.	6.385,89	6.888,63	8.227,45				
14	BBN2211361400060.	6.861,50	7.400,15	8.834,60				
15	BBN2211361500060.	7.337,11	7.911,67	9.441,75				
16	BBN2211361600060.	7.812,72	8.423,19	10.048,90				
17	BBN2211361700060.	8.288,33	8.934,71	10.656,05				
18	BBN2211361800060.	8.763,94	9.446,23	11.263,20				

H1220 mm

No. of bays	Item no. Freestanding bay	Melamine EUR	Painted EUR	Veneer EUR	Item no. Intermediate bay	Melamine EUR	Painted EUR	Veneer EUR
1	BBN2211460100060.	800,13	893,23	1.141,93	BBN2214460100060.	536,39	582,94	707,29
2	BBN2211460200060.	1.336,52	1.476,17	1.849,22	BBN2214460200060.	1.072,78	1.165,88	1.414,58
3	BBN2211460300060.	1.872,91	2.059,11	2.556,51	BBN2214460300060.	1.609,17	1.748,82	2.121,87
4	BBN2211460400060.	2.409,30	2.642,05	3.263,80	BBN2214460400060.	2.145,56	2.331,76	2.829,16
5	BBN2211460500060.	2.945,69	3.224,99	3.971,09	BBN2214460500060.	2.681,95	2.914,70	3.536,45
6	BBN2211460600060.	3.482,08	3.807,93	4.678,38	BBN2214460600060.	3.218,34	3.497,64	4.243,74
7	BBN2211460700060.	4.018,47	4.390,87	5.385,67	BBN2214460700060.	3.754,73	4.080,58	4.951,03
8	BBN2211460800060.	4.554,86	4.973,81	6.092,96	BBN2214460800060.	4.291,12	4.663,52	5.658,32
9	BBN2211460900060.	5.091,25	5.556,75	6.800,25	BBN2214460900060.	4.827,51	5.246,46	6.365,61
10	BBN2211461000060.	5.627,64	6.139,69	7.507,54	BBN2214461000060.	5.363,90	5.829,40	7.072,90
11	BBN2211461100060.	6.164,03	6.722,63	8.214,83				
12	BBN2211461200060.	6.700,42	7.305,57	8.922,12				
13	BBN2211461300060.	7.236,81	7.888,51	9.629,41				
14	BBN2211461400060.	7.773,20	8.471,45	10.336,70				
15	BBN2211461500060.	8.309,59	9.054,39	11.043,99				
16	BBN2211461600060.	8.845,98	9.637,33	11.751,28				
17	BBN2211461700060.	9.382,37	10.220,27	12.458,57				
18	BBN2211461800060.	9.918,76	10.803,21	13.165,86				

LINGO ROUND SHELVING SYSTEM

18° - STEEL BACK FRAME - ADJUSTABLE FEET - FOR TOP SHELF

Painted and veneered Lingo Shelving Systems are FSC-certified.

H1520 mm

No. of bays	Item no. Freestanding bay	Melamine EUR	Painted EUR	Veneer EUR	Item no. Intermediate bay	Melamine EUR	Painted EUR	Veneer EUR
1	BBN2211560100060.	828,33	926,47	1.188,49	BBN2214560100060.	550,49	599,56	730,57
2	BBN2211560200060.	1.378,82	1.526,03	1.919,06	BBN2214560200060.	1.100,98	1.199,12	1.461,14
3	BBN2211560300060.	1.929,31	2.125,59	2.649,63	BBN2214560300060.	1.651,47	1.798,68	2.191,71
4	BBN2211560400060.	2.479,80	2.725,15	3.380,20	BBN2214560400060.	2.201,96	2.398,24	2.922,28
5	BBN2211560500060.	3.030,29	3.324,71	4.110,77	BBN2214560500060.	2.752,45	2.997,80	3.652,85
6	BBN2211560600060.	3.580,78	3.924,27	4.841,34	BBN2214560600060.	3.302,94	3.597,36	4.383,42
7	BBN2211560700060.	4.131,27	4.523,83	5.571,91	BBN2214560700060.	3.853,43	4.196,92	5.113,99
8	BBN2211560800060.	4.681,76	5.123,39	6.302,48	BBN2214560800060.	4.403,92	4.796,48	5.844,56
9	BBN2211560900060.	5.232,25	5.722,95	7.033,05	BBN2214560900060.	4.954,41	5.396,04	6.575,13
10	BBN2211561000060.	5.782,74	6.322,51	7.763,62	BBN2214561000060.	5.504,90	5.995,60	7.305,70
11	BBN2211561100060.	6.333,23	6.922,07	8.494,19				
12	BBN2211561200060.	6.883,72	7.521,63	9.224,76				
13	BBN2211561300060.	7.434,21	8.121,19	9.955,33				
14	BBN2211561400060.	7.984,70	8.720,75	10.685,90				
15	BBN2211561500060.	8.535,19	9.320,31	11.416,47				
16	BBN2211561600060.	9.085,68	9.919,87	12.147,04				
17	BBN2211561700060.	9.636,17	10.519,43	12.877,61				
18	BBN2211561800060.	10.186,66	11.118,99	13.608,18				

H1820 mm

No. of bays	Item no. Freestanding bay	Melamine EUR	Painted EUR	Veneer EUR	Item no. Intermediate bay	Melamine EUR	Painted EUR	Veneer EUR
1	BBN2211660100060.	929,13	1.045,39	1.354,21	BBN2214660100060.	600,89	659,02	813,43
2	BBN2211660200060.	1.530,02	1.704,41	2.167,64	BBN2214660200060.	1.201,78	1.318,04	1.626,86
3	BBN2211660300060.	2.130,91	2.363,43	2.981,07	BBN2214660300060.	1.802,67	1.977,06	2.440,29
4	BBN2211660400060.	2.731,80	3.022,45	3.794,50	BBN2214660400060.	2.403,56	2.636,08	3.253,72
5	BBN2211660500060.	3.332,69	3.681,47	4.607,93	BBN2214660500060.	3.004,45	3.295,10	4.067,15
6	BBN2211660600060.	3.933,58	4.340,49	5.421,36	BBN2214660600060.	3.605,34	3.954,12	4.880,58
7	BBN2211660700060.	4.534,47	4.999,51	6.234,79	BBN2214660700060.	4.206,23	4.613,14	5.694,01
8	BBN2211660800060.	5.135,36	5.658,53	7.048,22	BBN2214660800060.	4.807,12	5.272,16	6.507,44
9	BBN2211660900060.	5.736,25	6.317,55	7.861,65	BBN2214660900060.	5.408,01	5.931,18	7.320,87
10	BBN2211661000060.	6.337,14	6.976,57	8.675,08	BBN2214661000060.	6.008,90	6.590,20	8.134,30
11	BBN2211661100060.	6.938,03	7.635,59	9.488,51				
12	BBN2211661200060.	7.538,92	8.294,61	10.301,94				
13	BBN2211661300060.	8.139,81	8.953,63	11.115,37				
14	BBN2211661400060.	8.740,70	9.612,65	11.928,80				
15	BBN2211661500060.	9.341,59	10.271,67	12.742,23				
16	BBN2211661600060.	9.942,48	10.930,69	13.555,66				
17	BBN2211661700060.	10.543,37	11.589,71	14.369,09				
18	BBN2211661800060.	11.144,26	12.248,73	15.182,52				

H2120 mm

No. of bays	Item no. Freestanding bay	Melamine EUR	Painted EUR	Veneer EUR	Item no. Intermediate bay	Melamine EUR	Painted EUR	Veneer EUR
1	BBN2211760100060.	1.026,49	1.159,77	1.514,61	BBN2214760100060.	649,57	716,21	893,63
2	BBN2211760200060.	1.676,06	1.875,98	2.408,24	BBN2214760200060.	1.299,14	1.432,42	1.787,26
3	BBN2211760300060.	2.325,63	2.592,19	3.301,87	BBN2214760300060.	1.948,71	2.148,63	2.680,89
4	BBN2211760400060.	2.975,20	3.308,40	4.195,50	BBN2214760400060.	2.598,28	2.864,84	3.574,52
5	BBN2211760500060.	3.624,77	4.024,61	5.089,13	BBN2214760500060.	3.247,85	3.581,05	4.468,15
6	BBN2211760600060.	4.274,34	4.740,82	5.982,76	BBN2214760600060.	3.897,42	4.297,26	5.361,78
7	BBN2211760700060.	4.923,91	5.457,03	6.876,39	BBN2214760700060.	4.546,99	5.013,47	6.255,41
8	BBN2211760800060.	5.573,48	6.173,24	7.770,02	BBN2214760800060.	5.196,56	5.729,68	7.149,04
9	BBN2211760900060.	6.223,05	6.889,45	8.663,65	BBN2214760900060.	5.846,13	6.445,89	8.042,67
10	BBN2211761000060.	6.872,62	7.605,66	9.557,28	BBN2214761000060.	6.495,70	7.162,10	8.936,30
11	BBN2211761100060.	7.522,19	8.321,87	10.450,91				
12	BBN2211761200060.	8.171,76	9.038,08	11.344,54				
13	BBN2211761300060.	8.821,33	9.754,29	12.238,17				
14	BBN2211761400060.	9.470,90	10.470,50	13.131,80				
15	BBN2211761500060.	10.120,47	11.186,71	14.025,43				
16	BBN2211761600060.	10.770,04	11.902,92	14.919,06				
17	BBN2211761700060.	11.419,61	12.619,13	15.812,69				
18	BBN2211761800060.	12.069,18	13.335,34	16.706,32				

LINGO ROUND SHELVING SYSTEM

BBN221 - 18° - HIGH STEEL BACK PANEL - ADJUSTABLE FEET - FOR TOP SHELF



LINGO ROUND SHELVING SYSTEM

BBN221 - 18° - HIGH STEEL BACK PANEL - ADJUSTABLE FEET - FOR TOP SHELF

Round shelving system with wooden panels and high steel back panel.

To be used with top shelf WT5 standard depth top shelf.

Freestanding bay includes 2 wooden end panels and 1 high steel back panel.

Intermediate bay includes 1 intermediate wooden panel and 1 high steel back panel.

- Prices based on steel price group 1 and wooden price group A (see Design Options pages 6-9).

- For top shelves, see from page 340

- For shelves, see from page 328

- For castor frame, see page 347

- For end panel bay, see page 358

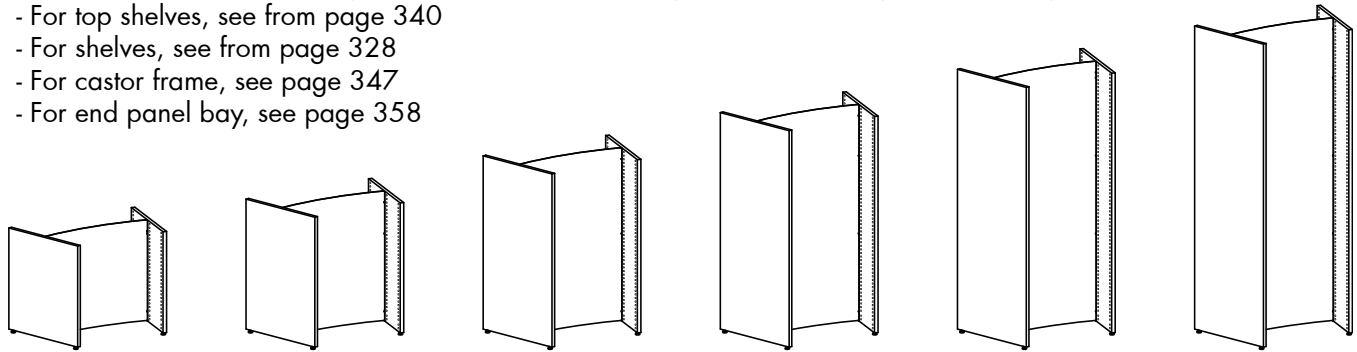

Double-sided freestanding bay - H720/920/1220/1520/1820/2120 mm

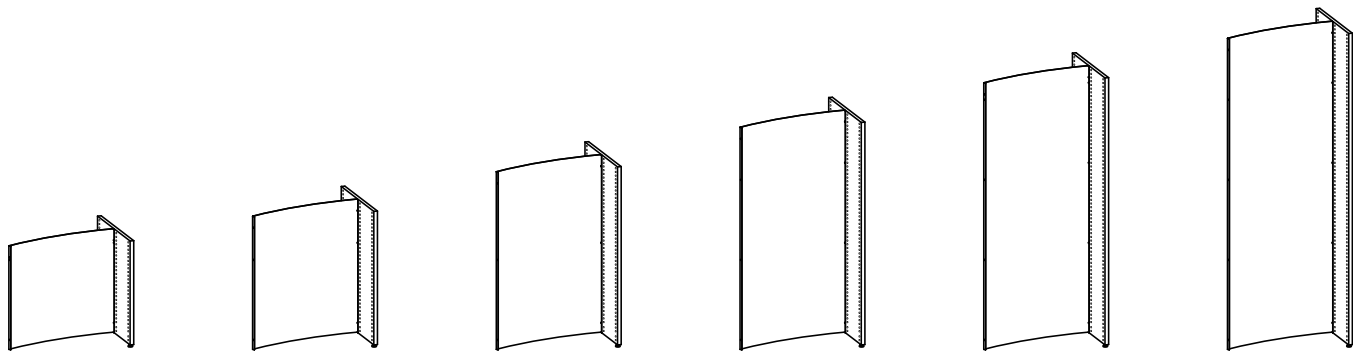

Double-sided intermediate bay - H720/920/1220/1520/1820/2120 mm

LINGO ROUND SHELVING SYSTEM

18° - HIGH STEEL BACK PANEL - ADJUSTABLE FEET - FOR TOP SHELF

Painted and veneered Lingo Shelving Systems are FSC-certified.

H720 mm

No. of bays	Item no. Freestanding bay	Melamine EUR	Painted EUR	Veneer EUR	Item no. Intermediate bay	Melamine EUR	Painted EUR	Veneer EUR
1	BBN2211260100070.	522,15	578,01	751,71	BBN2214260100070.	363,35	391,28	466,16
2	BBN2211260200070.	885,50	969,29	1.217,87	BBN2214260200070.	726,70	782,56	932,32
3	BBN2211260300070.	1.248,85	1.360,57	1.684,03	BBN2214260300070.	1.090,05	1.173,84	1.398,48
4	BBN2211260400070.	1.612,20	1.751,85	2.150,19	BBN2214260400070.	1.453,40	1.565,12	1.864,64
5	BBN2211260500070.	1.975,55	2.143,13	2.616,35	BBN2214260500070.	1.816,75	1.956,40	2.330,80
6	BBN2211260600070.	2.338,90	2.534,41	3.082,51	BBN2214260600070.	2.180,10	2.347,68	2.796,96
7	BBN2211260700070.	2.702,25	2.925,69	3.548,67	BBN2214260700070.	2.543,45	2.738,96	3.263,12
8	BBN2211260800070.	3.065,60	3.316,97	4.014,83	BBN2214260800070.	2.906,80	3.130,24	3.729,28
9	BBN2211260900070.	3.428,95	3.708,25	4.480,99	BBN2214260900070.	3.270,15	3.521,52	4.195,44
10	BBN2211261000070.	3.792,30	4.099,53	4.947,15	BBN2214261000070.	3.633,50	3.912,80	4.661,60
11	BBN2211261100070.	4.155,65	4.490,81	5.413,31				
12	BBN2211261200070.	4.519,00	4.882,09	5.879,47				
13	BBN2211261300070.	4.882,35	5.273,37	6.345,63				
14	BBN2211261400070.	5.245,70	5.664,65	6.811,79				
15	BBN2211261500070.	5.609,05	6.055,93	7.277,95				
16	BBN2211261600070.	5.972,40	6.447,21	7.744,11				
17	BBN2211261700070.	6.335,75	6.838,49	8.210,27				
18	BBN2211261800070.	6.699,10	7.229,77	8.676,43				

H920 mm

No. of bays	Item no. Freestanding bay	Melamine EUR	Painted EUR	Veneer EUR	Item no. Intermediate bay	Melamine EUR	Painted EUR	Veneer EUR
1	BBN2211360100070.	667,27	739,09	930,35	BBN2214360100070.	464,31	500,22	595,85
2	BBN2211360200070.	1.131,58	1.239,31	1.526,20	BBN2214360200070.	928,62	1.000,44	1.191,70
3	BBN2211360300070.	1.595,89	1.739,53	2.122,05	BBN2214360300070.	1.392,93	1.500,66	1.787,55
4	BBN2211360400070.	2.060,20	2.239,75	2.717,90	BBN2214360400070.	1.857,24	2.000,88	2.383,40
5	BBN2211360500070.	2.524,51	2.739,97	3.313,75	BBN2214360500070.	2.321,55	2.501,10	2.979,25
6	BBN2211360600070.	2.988,82	3.240,19	3.909,60	BBN2214360600070.	2.785,86	3.001,32	3.575,10
7	BBN2211360700070.	3.453,13	3.740,41	4.505,45	BBN2214360700070.	3.250,17	3.501,54	4.170,95
8	BBN2211360800070.	3.917,44	4.240,63	5.101,30	BBN2214360800070.	3.714,48	4.001,76	4.766,80
9	BBN2211360900070.	4.381,75	4.740,85	5.697,15	BBN2214360900070.	4.178,79	4.501,98	5.362,65
10	BBN2211361000070.	4.846,06	5.241,07	6.293,00	BBN2214361000070.	4.643,10	5.002,20	5.958,50
11	BBN2211361100070.	5.310,37	5.741,29	6.888,85				
12	BBN2211361200070.	5.774,68	6.241,51	7.484,70				
13	BBN2211361300070.	6.238,99	6.741,73	8.080,55				
14	BBN2211361400070.	6.703,30	7.241,95	8.676,40				
15	BBN2211361500070.	7.167,61	7.742,17	9.272,25				
16	BBN2211361600070.	7.631,92	8.242,39	9.868,10				
17	BBN2211361700070.	8.096,23	8.742,61	10.463,95				
18	BBN2211361800070.	8.560,54	9.242,83	11.059,80				

H1220 mm

No. of bays	Item no. Freestanding bay	Melamine EUR	Painted EUR	Veneer EUR	Item no. Intermediate bay	Melamine EUR	Painted EUR	Veneer EUR
1	BBN2211460100070.	874,08	967,18	1.215,88	BBN2214460100070.	610,34	656,89	781,24
2	BBN2211460200070.	1.484,42	1.624,07	1.997,12	BBN2214460200070.	1.220,68	1.313,78	1.562,48
3	BBN2211460300070.	2.094,76	2.280,96	2.778,36	BBN2214460300070.	1.831,02	1.970,67	2.343,72
4	BBN2211460400070.	2.705,10	2.937,85	3.559,60	BBN2214460400070.	2.441,36	2.627,56	3.124,96
5	BBN2211460500070.	3.315,44	3.594,74	4.340,84	BBN2214460500070.	3.051,70	3.284,45	3.906,20
6	BBN2211460600070.	3.925,78	4.251,63	5.122,08	BBN2214460600070.	3.662,04	3.941,34	4.687,44
7	BBN2211460700070.	4.536,12	4.908,52	5.903,32	BBN2214460700070.	4.272,38	4.598,23	5.468,68
8	BBN2211460800070.	5.146,46	5.565,41	6.684,56	BBN2214460800070.	4.882,72	5.255,12	6.249,92
9	BBN2211460900070.	5.756,80	6.222,30	7.465,80	BBN2214460900070.	5.493,06	5.912,01	7.031,16
10	BBN2211461000070.	6.367,14	6.879,19	8.247,04	BBN2214461000070.	6.103,40	6.568,90	7.812,40
11	BBN2211461100070.	6.977,48	7.536,08	9.028,28				
12	BBN2211461200070.	7.587,82	8.192,97	9.809,52				
13	BBN2211461300070.	8.198,16	8.849,86	10.590,76				
14	BBN2211461400070.	8.808,50	9.506,75	11.372,00				
15	BBN2211461500070.	9.418,84	10.163,64	12.153,24				
16	BBN2211461600070.	10.029,18	10.820,53	12.934,48				
17	BBN2211461700070.	10.639,52	11.477,42	13.715,72				
18	BBN2211461800070.	11.249,86	12.134,31	14.496,96				

LINGO ROUND SHELVING SYSTEM

18° - HIGH STEEL BACK PANEL - ADJUSTABLE FEET - FOR TOP SHELF

Painted and veneered Lingo Shelving Systems are FSC-certified.

H1520 mm

No. of bays	Item no. Freestanding bay	Melamine EUR	Painted EUR	Veneer EUR	Item no. Intermediate bay	Melamine EUR	Painted EUR	Veneer EUR
1	BBN2211560100070.	987,40	1.085,54	1.347,56	BBN2214560100070.	709,56	758,63	889,64
2	BBN2211560200070.	1.696,96	1.844,17	2.237,20	BBN2214560200070.	1.419,12	1.517,26	1.779,28
3	BBN2211560300070.	2.406,52	2.602,80	3.126,84	BBN2214560300070.	2.128,68	2.275,89	2.668,92
4	BBN2211560400070.	3.116,08	3.361,43	4.016,48	BBN2214560400070.	2.838,24	3.034,52	3.558,56
5	BBN2211560500070.	3.825,64	4.120,06	4.906,12	BBN2214560500070.	3.547,80	3.793,15	4.448,20
6	BBN2211560600070.	4.535,20	4.878,69	5.795,76	BBN2214560600070.	4.257,36	4.551,78	5.337,84
7	BBN2211560700070.	5.244,76	5.637,32	6.685,40	BBN2214560700070.	4.966,92	5.310,41	6.227,48
8	BBN2211560800070.	5.954,32	6.395,95	7.575,04	BBN2214560800070.	5.676,48	6.069,04	7.117,12
9	BBN2211560900070.	6.663,88	7.154,58	8.464,68	BBN2214560900070.	6.386,04	6.827,67	8.006,76
10	BBN2211561000070.	7.373,44	7.913,21	9.354,32	BBN2214561000070.	7.095,60	7.586,30	8.896,40
11	BBN2211561100070.	8.083,00	8.671,84	10.243,96				
12	BBN2211561200070.	8.792,56	9.430,47	11.133,60				
13	BBN2211561300070.	9.502,12	10.189,10	12.023,24				
14	BBN2211561400070.	10.211,68	10.947,73	12.912,88				
15	BBN2211561500070.	10.921,24	11.706,36	13.802,52				
16	BBN2211561600070.	11.630,80	12.464,99	14.692,16				
17	BBN2211561700070.	12.340,36	13.223,62	15.581,80				
18	BBN2211561800070.	13.049,92	13.982,25	16.471,44				

H1820 mm

No. of bays	Item no. Freestanding bay	Melamine EUR	Painted EUR	Veneer EUR	Item no. Intermediate bay	Melamine EUR	Painted EUR	Veneer EUR
1	BBN2211660100070.	1.173,45	1.289,71	1.598,53	BBN2214660100070.	845,21	903,34	1.057,75
2	BBN2211660200070.	2.018,66	2.193,05	2.656,28	BBN2214660200070.	1.690,42	1.806,68	2.115,50
3	BBN2211660300070.	2.863,87	3.096,39	3.714,03	BBN2214660300070.	2.535,63	2.710,02	3.173,25
4	BBN2211660400070.	3.709,08	3.999,73	4.771,78	BBN2214660400070.	3.380,84	3.613,36	4.231,00
5	BBN2211660500070.	4.554,29	4.903,07	5.829,53	BBN2214660500070.	4.226,05	4.516,70	5.288,75
6	BBN2211660600070.	5.399,50	5.806,41	6.887,28	BBN2214660600070.	5.071,26	5.420,04	6.346,50
7	BBN2211660700070.	6.244,71	6.709,75	7.945,03	BBN2214660700070.	5.916,47	6.323,38	7.404,25
8	BBN2211660800070.	7.089,92	7.613,09	9.002,78	BBN2214660800070.	6.761,68	7.226,72	8.462,00
9	BBN2211660900070.	7.935,13	8.516,43	10.060,53	BBN2214660900070.	7.606,89	8.130,06	9.519,75
10	BBN2211661000070.	8.780,34	9.419,77	11.118,28	BBN2214661000070.	8.452,10	9.033,40	10.577,50
11	BBN2211661100070.	9.625,55	10.323,11	12.176,03				
12	BBN2211661200070.	10.470,76	11.226,45	13.233,78				
13	BBN2211661300070.	11.315,97	12.129,79	14.291,53				
14	BBN2211661400070.	12.161,18	13.033,13	15.349,28				
15	BBN2211661500070.	13.006,39	13.936,47	16.407,03				
16	BBN2211661600070.	13.851,60	14.839,81	17.464,78				
17	BBN2211661700070.	14.696,81	15.743,15	18.522,53				
18	BBN2211661800070.	15.542,02	16.646,49	19.580,28				

H2120 mm

No. of bays	Item no. Freestanding bay	Melamine EUR	Painted EUR	Veneer EUR	Item no. Intermediate bay	Melamine EUR	Painted EUR	Veneer EUR
1	BBN2211760100070.	1.355,93	1.489,21	1.844,05	BBN2214760100070.	979,01	1.045,65	1.223,07
2	BBN2211760200070.	2.334,94	2.534,86	3.067,12	BBN2214760200070.	1.958,02	2.091,30	2.446,14
3	BBN2211760300070.	3.313,95	3.580,51	4.290,19	BBN2214760300070.	2.937,03	3.136,95	3.669,21
4	BBN2211760400070.	4.292,96	4.626,16	5.513,26	BBN2214760400070.	3.916,04	4.182,60	4.892,28
5	BBN2211760500070.	5.271,97	5.671,81	6.736,33	BBN2214760500070.	4.895,05	5.228,25	6.115,35
6	BBN2211760600070.	6.250,98	6.717,46	7.959,40	BBN2214760600070.	5.874,06	6.273,90	7.338,42
7	BBN2211760700070.	7.229,99	7.763,11	9.182,47	BBN2214760700070.	6.853,07	7.319,55	8.561,49
8	BBN2211760800070.	8.209,00	8.808,76	10.405,54	BBN2214760800070.	7.832,08	8.365,20	9.784,56
9	BBN2211760900070.	9.188,01	9.854,41	11.628,61	BBN2214760900070.	8.811,09	9.410,85	11.007,63
10	BBN2211761000070.	10.167,02	10.900,06	12.851,68	BBN2214761000070.	9.790,10	10.456,50	12.230,70
11	BBN2211761100070.	11.146,03	11.945,71	14.074,75				
12	BBN2211761200070.	12.125,04	12.991,36	15.297,82				
13	BBN2211761300070.	13.104,05	14.037,01	16.520,89				
14	BBN2211761400070.	14.083,06	15.082,66	17.743,96				
15	BBN2211761500070.	15.062,07	16.128,31	18.967,03				
16	BBN2211761600070.	16.041,08	17.173,96	20.190,10				
17	BBN2211761700070.	17.020,09	18.219,61	21.413,17				
18	BBN2211761800070.	17.999,10	19.265,26	22.636,24				

LINGO ROUND SHELVING SYSTEM

BBN221 - 18° - LOW STEEL BACK PANEL - ADJUSTABLE FEET - FOR TOP SHELF



LINGO ROUND SHELVING SYSTEM

BBN221 - 18° - LOW STEEL BACK PANEL - ADJUSTABLE FEET - FOR TOP SHELF

Round shelving system with wooden panels and low steel back panel.

To be used with top shelves WT5 full depth and WT5 double-sided top shelf.

Freestanding bay includes 2 end wooden panels and 1 low steel back panel.

Intermediate bay includes 1 intermediate wooden panel and 1 low steel back panel.

- Prices based on steel price group 1 and wooden price group A (see Design Options pages 6-9).

- For top shelves, see from page 340

- For shelves, see from page 328

- For plinths, see page 349

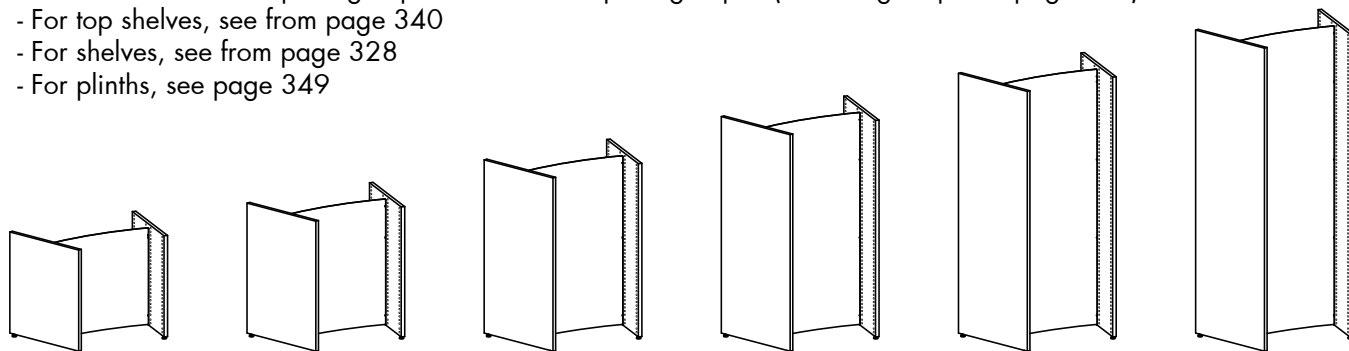

Double-sided freestanding bay - H720/920/1220/1520/1820/2120 mm

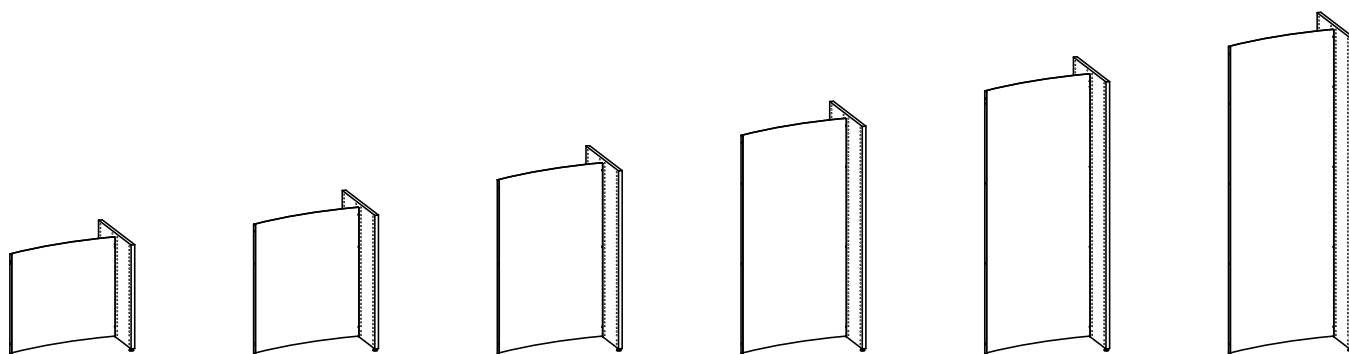

Double-sided intermediate bay - H720/920/1220/1520/1820/2120 mm

LINGO ROUND SHELVING SYSTEM

18° - LOW STEEL BACK PANEL - ADJUSTABLE FEET - FOR TOP SHELF

Painted and veneered Lingo Shelving Systems are FSC-certified.

H720 mm

No. of bays	Item no. Freestanding bay	Melamine EUR	Painted EUR	Veneer EUR	Item no. Intermediate bay	Melamine EUR	Painted EUR	Veneer EUR
1	BBN2211260100080.	522,15	578,01	751,71	BBN2214260100080.	363,35	391,28	466,16
2	BBN2211260200080.	885,50	969,29	1.217,87	BBN2214260200080.	726,70	782,56	932,32
3	BBN2211260300080.	1.248,85	1.360,57	1.684,03	BBN2214260300080.	1.090,05	1.173,84	1.398,48
4	BBN2211260400080.	1.612,20	1.751,85	2.150,19	BBN2214260400080.	1.453,40	1.565,12	1.864,64
5	BBN2211260500080.	1.975,55	2.143,13	2.616,35	BBN2214260500080.	1.816,75	1.956,40	2.330,80
6	BBN2211260600080.	2.338,90	2.534,41	3.082,51	BBN2214260600080.	2.180,10	2.347,68	2.796,96
7	BBN2211260700080.	2.702,25	2.925,69	3.548,67	BBN2214260700080.	2.543,45	2.738,96	3.263,12
8	BBN2211260800080.	3.065,60	3.316,97	4.014,83	BBN2214260800080.	2.906,80	3.130,24	3.729,28
9	BBN2211260900080.	3.428,95	3.708,25	4.480,99	BBN2214260900080.	3.270,15	3.521,52	4.195,44
10	BBN2211261000080.	3.792,30	4.099,53	4.947,15	BBN2214261000080.	3.633,50	3.912,80	4.661,60
11	BBN2211261100080.	4.155,65	4.490,81	5.413,31				
12	BBN2211261200080.	4.519,00	4.882,09	5.879,47				
13	BBN2211261300080.	4.882,35	5.273,37	6.345,63				
14	BBN2211261400080.	5.245,70	5.664,65	6.811,79				
15	BBN2211261500080.	5.609,05	6.055,93	7.277,95				
16	BBN2211261600080.	5.972,40	6.447,21	7.744,11				
17	BBN2211261700080.	6.335,75	6.838,49	8.210,27				
18	BBN2211261800080.	6.699,10	7.229,77	8.676,43				

H920 mm

No. of bays	Item no. Freestanding bay	Melamine EUR	Painted EUR	Veneer EUR	Item no. Intermediate bay	Melamine EUR	Painted EUR	Veneer EUR
1	BBN2211360100080.	667,27	739,09	930,35	BBN2214360100080.	464,31	500,22	595,85
2	BBN2211360200080.	1.131,58	1.239,31	1.526,20	BBN2214360200080.	928,62	1.000,44	1.191,70
3	BBN2211360300080.	1.595,89	1.739,53	2.122,05	BBN2214360300080.	1.392,93	1.500,66	1.787,55
4	BBN2211360400080.	2.060,20	2.239,75	2.717,90	BBN2214360400080.	1.857,24	2.000,88	2.383,40
5	BBN2211360500080.	2.524,51	2.739,97	3.313,75	BBN2214360500080.	2.321,55	2.501,10	2.979,25
6	BBN2211360600080.	2.988,82	3.240,19	3.909,60	BBN2214360600080.	2.785,86	3.001,32	3.575,10
7	BBN2211360700080.	3.453,13	3.740,41	4.505,45	BBN2214360700080.	3.250,17	3.501,54	4.170,95
8	BBN2211360800080.	3.917,44	4.240,63	5.101,30	BBN2214360800080.	3.714,48	4.001,76	4.766,80
9	BBN2211360900080.	4.381,75	4.740,85	5.697,15	BBN2214360900080.	4.178,79	4.501,98	5.362,65
10	BBN2211361000080.	4.846,06	5.241,07	6.293,00	BBN2214361000080.	4.643,10	5.002,20	5.958,50
11	BBN2211361100080.	5.310,37	5.741,29	6.888,85				
12	BBN2211361200080.	5.774,68	6.241,51	7.484,70				
13	BBN2211361300080.	6.238,99	6.741,73	8.080,55				
14	BBN2211361400080.	6.703,30	7.241,95	8.676,40				
15	BBN2211361500080.	7.167,61	7.742,17	9.272,25				
16	BBN2211361600080.	7.631,92	8.242,39	9.868,10				
17	BBN2211361700080.	8.096,23	8.742,61	10.463,95				
18	BBN2211361800080.	8.560,54	9.242,83	11.059,80				

H1220 mm

No. of bays	Item no. Freestanding bay	Melamine EUR	Painted EUR	Veneer EUR	Item no. Intermediate bay	Melamine EUR	Painted EUR	Veneer EUR
1	BBN2211460100080.	874,08	967,18	1.215,88	BBN2214460100080.	610,34	656,89	781,24
2	BBN2211460200080.	1.484,42	1.624,07	1.997,12	BBN2214460200080.	1.220,68	1.313,78	1.562,48
3	BBN2211460300080.	2.094,76	2.280,96	2.778,36	BBN2214460300080.	1.831,02	1.970,67	2.343,72
4	BBN2211460400080.	2.705,10	2.937,85	3.559,60	BBN2214460400080.	2.441,36	2.627,56	3.124,96
5	BBN2211460500080.	3.315,44	3.594,74	4.340,84	BBN2214460500080.	3.051,70	3.284,45	3.906,20
6	BBN2211460600080.	3.925,78	4.251,63	5.122,08	BBN2214460600080.	3.662,04	3.941,34	4.687,44
7	BBN2211460700080.	4.536,12	4.908,52	5.903,32	BBN2214460700080.	4.272,38	4.598,23	5.468,68
8	BBN2211460800080.	5.146,46	5.565,41	6.684,56	BBN2214460800080.	4.882,72	5.255,12	6.249,92
9	BBN2211460900080.	5.756,80	6.222,30	7.465,80	BBN2214460900080.	5.493,06	5.912,01	7.031,16
10	BBN2211461000080.	6.367,14	6.879,19	8.247,04	BBN2214461000080.	6.103,40	6.568,90	7.812,40
11	BBN2211461100080.	6.977,48	7.536,08	9.028,28				
12	BBN2211461200080.	7.587,82	8.192,97	9.809,52				
13	BBN2211461300080.	8.198,16	8.849,86	10.590,76				
14	BBN2211461400080.	8.808,50	9.506,75	11.372,00				
15	BBN2211461500080.	9.418,84	10.163,64	12.153,24				
16	BBN2211461600080.	10.029,18	10.820,53	12.934,48				
17	BBN2211461700080.	10.639,52	11.477,42	13.715,72				
18	BBN2211461800080.	11.249,86	12.134,31	14.496,96				

LINGO ROUND SHELVING SYSTEM

18° - LOW STEEL BACK PANEL - ADJUSTABLE FEET - FOR TOP SHELF

Painted and veneered Lingo Shelving Systems are FSC-certified.

H1520 mm

No. of bays	Item no. Freestanding bay	Melamine EUR	Painted EUR	Veneer EUR	Item no. Intermediate bay	Melamine EUR	Painted EUR	Veneer EUR
1	BBN2211560100080.	987,40	1.085,54	1.347,56	BBN2214560100080.	709,56	758,63	889,64
2	BBN2211560200080.	1.696,96	1.844,17	2.237,20	BBN2214560200080.	1.419,12	1.517,26	1.779,28
3	BBN2211560300080.	2.406,52	2.602,80	3.126,84	BBN2214560300080.	2.128,68	2.275,89	2.668,92
4	BBN2211560400080.	3.116,08	3.361,43	4.016,48	BBN2214560400080.	2.838,24	3.034,52	3.558,56
5	BBN2211560500080.	3.825,64	4.120,06	4.906,12	BBN2214560500080.	3.547,80	3.793,15	4.448,20
6	BBN2211560600080.	4.535,20	4.878,69	5.795,76	BBN2214560600080.	4.257,36	4.551,78	5.337,84
7	BBN2211560700080.	5.244,76	5.637,32	6.685,40	BBN2214560700080.	4.966,92	5.310,41	6.227,48
8	BBN2211560800080.	5.954,32	6.395,95	7.575,04	BBN2214560800080.	5.676,48	6.069,04	7.117,12
9	BBN2211560900080.	6.663,88	7.154,58	8.464,68	BBN2214560900080.	6.386,04	6.827,67	8.006,76
10	BBN2211561000080.	7.373,44	7.913,21	9.354,32	BBN2214561000080.	7.095,60	7.586,30	8.896,40
11	BBN2211561100080.	8.083,00	8.671,84	10.243,96				
12	BBN2211561200080.	8.792,56	9.430,47	11.133,60				
13	BBN2211561300080.	9.502,12	10.189,10	12.023,24				
14	BBN2211561400080.	10.211,68	10.947,73	12.912,88				
15	BBN2211561500080.	10.921,24	11.706,36	13.802,52				
16	BBN2211561600080.	11.630,80	12.464,99	14.692,16				
17	BBN2211561700080.	12.340,36	13.223,62	15.581,80				
18	BBN2211561800080.	13.049,92	13.982,25	16.471,44				

H1820 mm

No. of bays	Item no. Freestanding bay	Melamine EUR	Painted EUR	Veneer EUR	Item no. Intermediate bay	Melamine EUR	Painted EUR	Veneer EUR
1	BBN2211660100080.	1.173,45	1.289,71	1.598,53	BBN2214660100080.	845,21	903,34	1.057,75
2	BBN2211660200080.	2.018,66	2.193,05	2.656,28	BBN2214660200080.	1.690,42	1.806,68	2.115,50
3	BBN2211660300080.	2.863,87	3.096,39	3.714,03	BBN2214660300080.	2.535,63	2.710,02	3.173,25
4	BBN2211660400080.	3.709,08	3.999,73	4.771,78	BBN2214660400080.	3.380,84	3.613,36	4.231,00
5	BBN2211660500080.	4.554,29	4.903,07	5.829,53	BBN2214660500080.	4.226,05	4.516,70	5.288,75
6	BBN2211660600080.	5.399,50	5.806,41	6.887,28	BBN2214660600080.	5.071,26	5.420,04	6.346,50
7	BBN2211660700080.	6.244,71	6.709,75	7.945,03	BBN2214660700080.	5.916,47	6.323,38	7.404,25
8	BBN2211660800080.	7.089,92	7.613,09	9.002,78	BBN2214660800080.	6.761,68	7.226,72	8.462,00
9	BBN2211660900080.	7.935,13	8.516,43	10.060,53	BBN2214660900080.	7.606,89	8.130,06	9.519,75
10	BBN2211661000080.	8.780,34	9.419,77	11.118,28	BBN2214661000080.	8.452,10	9.033,40	10.577,50
11	BBN2211661100080.	9.625,55	10.323,11	12.176,03				
12	BBN2211661200080.	10.470,76	11.226,45	13.233,78				
13	BBN2211661300080.	11.315,97	12.129,79	14.291,53				
14	BBN2211661400080.	12.161,18	13.033,13	15.349,28				
15	BBN2211661500080.	13.006,39	13.936,47	16.407,03				
16	BBN2211661600080.	13.851,60	14.839,81	17.464,78				
17	BBN2211661700080.	14.696,81	15.743,15	18.522,53				
18	BBN2211661800080.	15.542,02	16.646,49	19.580,28				

H2120 mm

No. of bays	Item no. Freestanding bay	Melamine EUR	Painted EUR	Veneer EUR	Item no. Intermediate bay	Melamine EUR	Painted EUR	Veneer EUR
1	BBN2211760100080.	1.355,93	1.489,21	1.844,05	BBN2214760100080.	979,01	1.045,65	1.223,07
2	BBN2211760200080.	2.334,94	2.534,86	3.067,12	BBN2214760200080.	1.958,02	2.091,30	2.446,14
3	BBN2211760300080.	3.313,95	3.580,51	4.290,19	BBN2214760300080.	2.937,03	3.136,95	3.669,21
4	BBN2211760400080.	4.292,96	4.626,16	5.513,26	BBN2214760400080.	3.916,04	4.182,60	4.892,28
5	BBN2211760500080.	5.271,97	5.671,81	6.736,33	BBN2214760500080.	4.895,05	5.228,25	6.115,35
6	BBN2211760600080.	6.250,98	6.717,46	7.959,40	BBN2214760600080.	5.874,06	6.273,90	7.338,42
7	BBN2211760700080.	7.229,99	7.763,11	9.182,47	BBN2214760700080.	6.853,07	7.319,55	8.561,49
8	BBN2211760800080.	8.209,00	8.808,76	10.405,54	BBN2214760800080.	7.832,08	8.365,20	9.784,56
9	BBN2211760900080.	9.188,01	9.854,41	11.628,61	BBN2214760900080.	8.811,09	9.410,85	11.007,63
10	BBN2211761000080.	10.167,02	10.900,06	12.851,68	BBN2214761000080.	9.790,10	10.456,50	12.230,70
11	BBN2211761100080.	11.146,03	11.945,71	14.074,75				
12	BBN2211761200080.	12.125,04	12.991,36	15.297,82				
13	BBN2211761300080.	13.104,05	14.037,01	16.520,89				
14	BBN2211761400080.	14.083,06	15.082,66	17.743,96				
15	BBN2211761500080.	15.062,07	16.128,31	18.967,03				
16	BBN2211761600080.	16.041,08	17.173,96	20.190,10				
17	BBN2211761700080.	17.020,09	18.219,61	21.413,17				
18	BBN2211761800080.	17.999,10	19.265,26	22.636,24				

LINGO ROUND SHELVING SYSTEM

BBN222 - 18° - STEEL BACK FRAME - ADJUSTABLE FEET - WITH TOP PLATE



LINGO ROUND SHELVING SYSTEM

BBN222 - 18° - STEEL BACK FRAME - ADJUSTABLE FEET - WITH TOP PLATE

Round shelving system with wooden end panels, intermediate panels, steel back frame and overlaying top plate. See further description on starter, intermediate and end sections on pages 26-27.

- Prices based on steel price group 1 and wooden price group A (see Design Options pages 6-9).
- For shelves, see from page 328
- For end panel bays, see page 378
- For plinths, see page 349

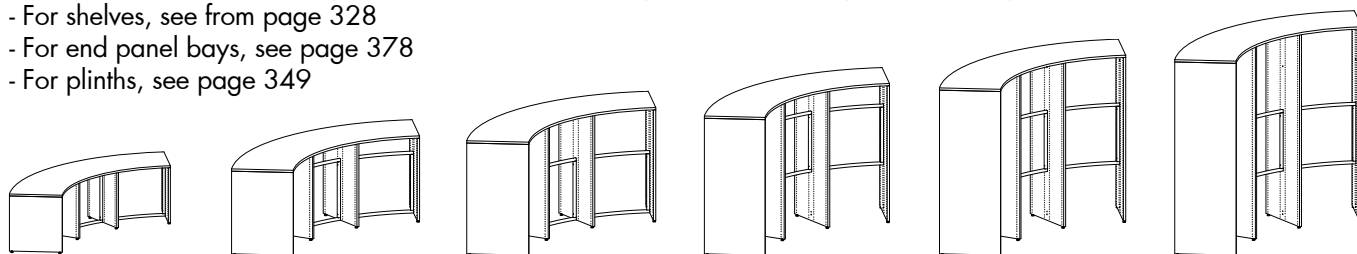

Freestanding 26° double-sided bays - H720/920/1220/1520/1820/2120 mm

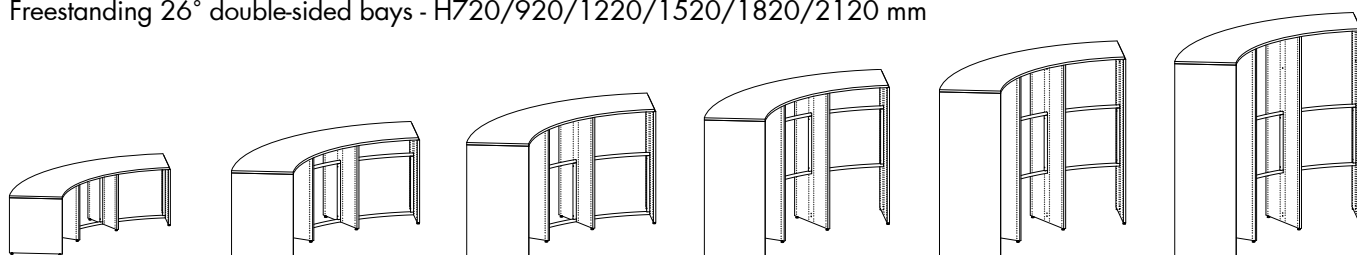

Left starter 26° double-sided bays - H720/920/1220/1520/1820/2120 mm

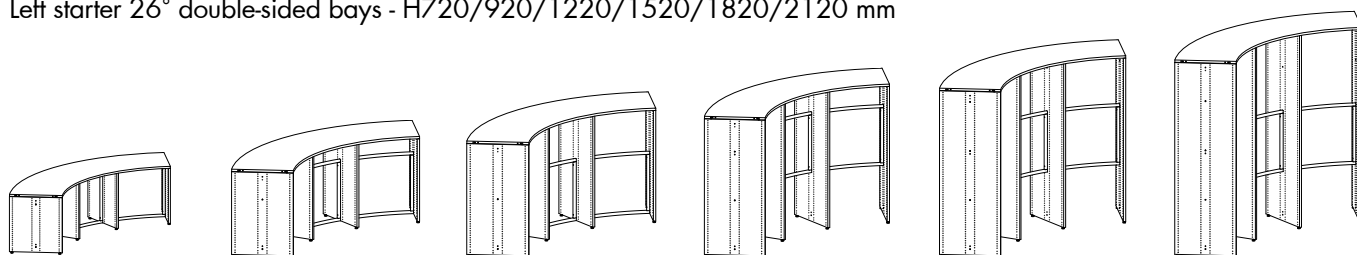

Right starter 26° double-sided bays - H720/920/1220/1520/1820/2120 mm

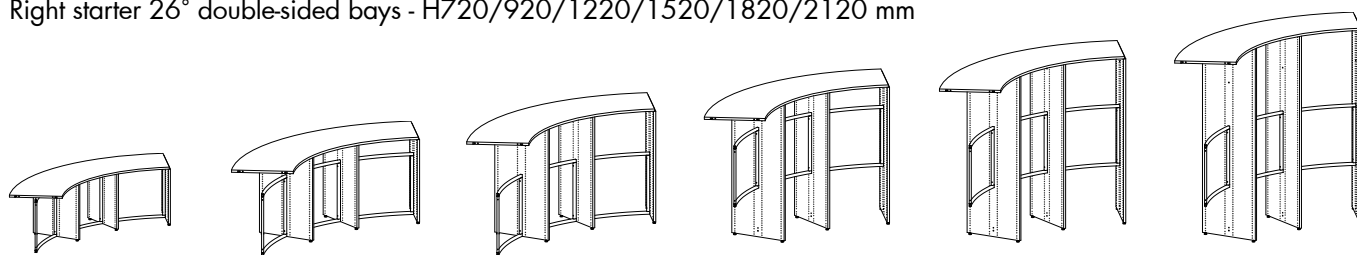

Intermediate 26° double-sided bays - H720/920/1220/1520/1820/2120 mm

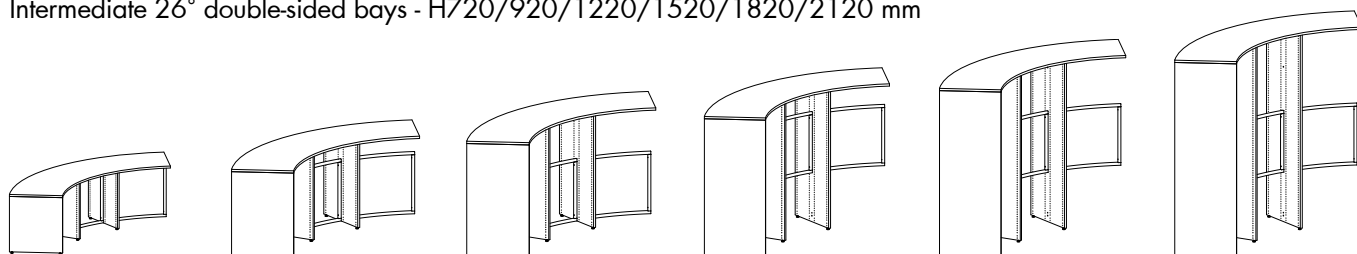

Left end 26° double-sided bays - H720/920/1220/1520/1820/2120 mm

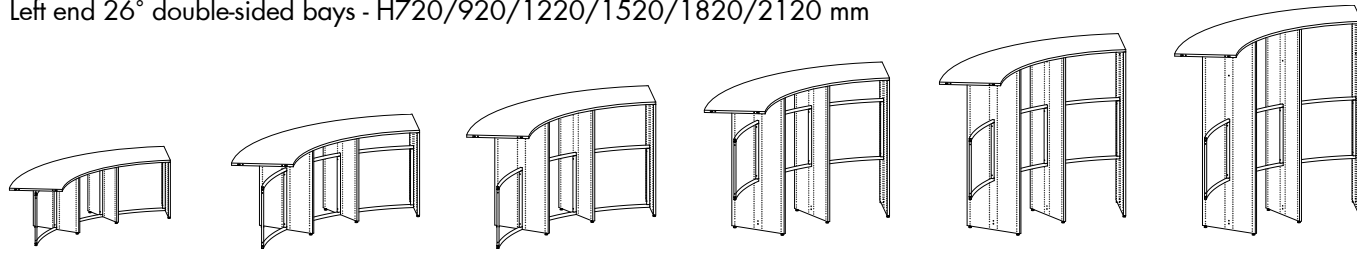

Right end 26° double-sided bays - H720/920/1220/1520/1820/2120 mm

LINGO ROUND SHELVING SYSTEM

18° - STEEL BACK FRAME - ADJUSTABLE FEET - WITH TOP PLATE - FREESTANDING SECTION

Painted and veneered Lingo Shelving Systems are FSC-certified.

H720 mm

No. of bays	Item no.	Melamine EUR	Painted EUR	Veneer EUR
1	BBN2221260110060.	1.092,72	1.237,16	1.623,53
2	BBN2221260210060.	2.045,93	2.310,47	3.017,10
3	BBN2221260310060.	2.956,18	3.333,11	4.339,92

H920 mm

No. of bays	Item no.	Melamine EUR	Painted EUR	Veneer EUR
1	BBN2221360110060.	1.181,04	1.341,44	1.769,31
2	BBN2221360210060.	2.178,41	2.466,89	3.235,77
3	BBN2221360310060.	3.132,82	3.541,67	4.631,48

H1220 mm

No. of bays	Item no.	Melamine EUR	Painted EUR	Veneer EUR
1	BBN2221460110060.	1.302,60	1.484,28	1.969,59
2	BBN2221460210060.	2.360,75	2.681,15	3.536,19
3	BBN2221460310060.	3.375,94	3.827,35	5.032,04

H1520 mm

No. of bays	Item no.	Melamine EUR	Painted EUR	Veneer EUR
1	BBN2221560110060.	1.330,80	1.517,52	2.016,15
2	BBN2221560210060.	2.403,05	2.731,01	3.606,03
3	BBN2221560310060.	3.432,34	3.893,83	5.125,16

H1820 mm

No. of bays	Item no.	Melamine EUR	Painted EUR	Veneer EUR
1	BBN2221660110060.	1.431,60	1.636,44	2.181,87
2	BBN2221660210060.	2.554,25	2.909,39	3.854,61
3	BBN2221660310060.	3.633,94	4.131,67	5.456,60

H2120 mm

No. of bays	Item no.	Melamine EUR	Painted EUR	Veneer EUR
1	BBN2221760110060.	1.528,96	1.750,82	2.342,27
2	BBN2221760210060.	2.700,29	3.080,96	4.095,21
3	BBN2221760310060.	3.828,66	4.360,43	5.777,40

LINGO ROUND SHELVING SYSTEM

18° - STEEL BACK FRAME - ADJUSTABLE FEET - WITH TOP PLATE - LEFT STARTER SECTION

Painted and veneered Lingo Shelving Systems are FSC-certified.

H720 mm

No. of bays	Item no.	Melamine EUR	Painted EUR	Veneer EUR
1	BBN2222260110060.	1.091,13	1.235,30	1.620,74
2	BBN2222260210060.	2.044,87	2.309,14	3.015,24
3	BBN2222260310060.	2.955,52	3.332,31	4.338,86

H920 mm

No. of bays	Item no.	Melamine EUR	Painted EUR	Veneer EUR
1	BBN2222360110060.	1.179,45	1.339,58	1.766,52
2	BBN2222360210060.	2.177,35	2.465,56	3.233,91
3	BBN2222360310060.	3.132,16	3.540,87	4.630,42

H1220 mm

No. of bays	Item no.	Melamine EUR	Painted EUR	Veneer EUR
1	BBN2222460110060.	1.301,01	1.482,42	1.966,80
2	BBN2222460210060.	2.359,69	2.679,82	3.534,33
3	BBN2222460310060.	3.375,28	3.826,55	5.030,98

H1520 mm

No. of bays	Item no.	Melamine EUR	Painted EUR	Veneer EUR
1	BBN2222560110060.	1.329,21	1.515,66	2.013,36
2	BBN2222560210060.	2.401,99	2.729,68	3.604,17
3	BBN2222560310060.	3.431,68	3.893,03	5.124,10

H1820 mm

No. of bays	Item no.	Melamine EUR	Painted EUR	Veneer EUR
1	BBN2222660110060.	1.430,01	1.634,58	2.179,08
2	BBN2222660210060.	2.553,19	2.908,06	3.852,75
3	BBN2222660310060.	3.633,28	4.130,87	5.455,54

H2120 mm

No. of bays	Item no.	Melamine EUR	Painted EUR	Veneer EUR
1	BBN2222760110060.	1.527,37	1.748,96	2.339,48
2	BBN2222760210060.	2.699,23	3.079,63	4.093,35
3	BBN2222760310060.	3.828,00	4.359,63	5.776,34

LINGO ROUND SHELVING SYSTEM

18° - STEEL BACK FRAME - ADJUSTABLE FEET - WITH TOP PLATE - RIGHT STARTER SECTION

Painted and veneered Lingo Shelving Systems are FSC-certified.

H720 mm

No. of bays	Item no.	Melamine EUR	Painted EUR	Veneer EUR
1	BBN2223260110060.	1.091,13	1.235,30	1.620,74
2	BBN2223260210060.	2.044,87	2.309,14	3.015,24
3	BBN2223260310060.	2.955,52	3.332,31	4.338,86

H920 mm

No. of bays	Item no.	Melamine EUR	Painted EUR	Veneer EUR
1	BBN2223360110060.	1.179,45	1.339,58	1.766,52
2	BBN2223360210060.	2.177,35	2.465,56	3.233,91
3	BBN2223360310060.	3.132,16	3.540,87	4.630,42

H1220 mm

No. of bays	Item no.	Melamine EUR	Painted EUR	Veneer EUR
1	BBN2223460110060.	1.301,01	1.482,42	1.966,80
2	BBN2223460210060.	2.359,69	2.679,82	3.534,33
3	BBN2223460310060.	3.375,28	3.826,55	5.030,98

H1520 mm

No. of bays	Item no.	Melamine EUR	Painted EUR	Veneer EUR
1	BBN2223560110060.	1.329,21	1.515,66	2.013,36
2	BBN2223560210060.	2.401,99	2.729,68	3.604,17
3	BBN2223560310060.	3.431,68	3.893,03	5.124,10

H1820 mm

No. of bays	Item no.	Melamine EUR	Painted EUR	Veneer EUR
1	BBN2223660110060.	1.430,01	1.634,58	2.179,08
2	BBN2223660210060.	2.553,19	2.908,06	3.852,75
3	BBN2223660310060.	3.633,28	4.130,87	5.455,54

H2120 mm

No. of bays	Item no.	Melamine EUR	Painted EUR	Veneer EUR
1	BBN2223760110060.	1.527,37	1.748,96	2.339,48
2	BBN2223760210060.	2.699,23	3.079,63	4.093,35
3	BBN2223760310060.	3.828,00	4.359,63	5.776,34

LINGO ROUND SHELVING SYSTEM

18° - STEEL BACK FRAME - ADJUSTABLE FEET - WITH TOP PLATE - INTERMEDIATE SECTION

Painted and veneered Lingo Shelving Systems are FSC-certified.

H720 mm

No. of bays	Item no.	Melamine EUR	Painted EUR	Veneer EUR
1	BBN2224260110060.	927,81	1.043,25	1.351,68
2	BBN2224260210060.	1.866,92	2.100,07	2.722,38
3	BBN2224260310060.	2.784,08	3.130,81	4.056,63

H920 mm

No. of bays	Item no.	Melamine EUR	Painted EUR	Veneer EUR
1	BBN2224360110060.	971,97	1.095,39	1.424,57
2	BBN2224360210060.	1.955,24	2.204,35	2.868,16
3	BBN2224360310060.	2.916,56	3.287,23	4.275,30

H1220 mm

No. of bays	Item no.	Melamine EUR	Painted EUR	Veneer EUR
1	BBN2224460110060.	1.032,75	1.166,81	1.524,71
2	BBN2224460210060.	2.076,80	2.347,19	3.068,44
3	BBN2224460310060.	3.098,90	3.501,49	4.575,72

H1520 mm

No. of bays	Item no.	Melamine EUR	Painted EUR	Veneer EUR
1	BBN2224560110060.	1.046,85	1.183,43	1.547,99
2	BBN2224560210060.	2.105,00	2.380,43	3.115,00
3	BBN2224560310060.	3.141,20	3.551,35	4.645,56

H1820 mm

No. of bays	Item no.	Melamine EUR	Painted EUR	Veneer EUR
1	BBN2224660110060.	1.097,25	1.242,89	1.630,85
2	BBN2224660210060.	2.205,80	2.499,35	3.280,72
3	BBN2224660310060.	3.292,40	3.729,73	4.894,14

H2120 mm

No. of bays	Item no.	Melamine EUR	Painted EUR	Veneer EUR
1	BBN2224760110060.	1.145,93	1.300,08	1.711,05
2	BBN2224760210060.	2.303,16	2.613,73	3.441,12
3	BBN2224760310060.	3.438,44	3.901,30	5.134,74

LINGO ROUND SHELVING SYSTEM

18° - STEEL BACK FRAME - ADJUSTABLE FEET - WITH TOP PLATE - LEFT END SECTION

Painted and veneered Lingo Shelving Systems are FSC-certified.

H720 mm

No. of bays	Item no.	Melamine EUR	Painted EUR	Veneer EUR
1	BBN2225260110060.	932,33	1.048,57	1.359,13
2	BBN2225260210060.	1.886,07	2.122,41	2.753,63
3	BBN2225260310060.	2.796,72	3.145,58	4.077,25

H920 mm

No. of bays	Item no.	Melamine EUR	Painted EUR	Veneer EUR
1	BBN2225360110060.	976,49	1.100,71	1.432,02
2	BBN2225360210060.	1.974,39	2.226,69	2.899,41
3	BBN2225360310060.	2.929,20	3.302,00	4.295,92

H1220 mm

No. of bays	Item no.	Melamine EUR	Painted EUR	Veneer EUR
1	BBN2225460110060.	1.037,27	1.172,13	1.532,16
2	BBN2225460210060.	2.095,95	2.369,53	3.099,69
3	BBN2225460310060.	3.111,54	3.516,26	4.596,34

H1520 mm

No. of bays	Item no.	Melamine EUR	Painted EUR	Veneer EUR
1	BBN2225560110060.	1.051,37	1.188,75	1.555,44
2	BBN2225560210060.	2.124,15	2.402,77	3.146,25
3	BBN2225560310060.	3.153,84	3.566,12	4.666,18

H1820 mm

No. of bays	Item no.	Melamine EUR	Painted EUR	Veneer EUR
1	BBN2225660110060.	1.101,77	1.248,21	1.638,30
2	BBN2225660210060.	2.224,95	2.521,69	3.311,97
3	BBN2225660310060.	3.305,04	3.744,50	4.914,76

H2120 mm

No. of bays	Item no.	Melamine EUR	Painted EUR	Veneer EUR
1	BBN2225760110060.	1.150,45	1.305,40	1.718,50
2	BBN2225760210060.	2.322,31	2.636,07	3.472,37
3	BBN2225760310060.	3.451,08	3.916,07	5.155,36

LINGO ROUND SHELVING SYSTEM

18° - STEEL BACK FRAME - ADJUSTABLE FEET - WITH TOP PLATE - RIGHT END SECTION

Painted and veneered Lingo Shelving Systems are FSC-certified.

H720 mm

No. of bays	Item no.	Melamine EUR	Painted EUR	Veneer EUR
1	BBN2226260110060.	932,33	1.048,57	1.359,13
2	BBN2226260210060.	1.886,07	2.122,41	2.753,63
3	BBN2226260310060.	2.796,72	3.145,58	4.077,25

H920 mm

No. of bays	Item no.	Melamine EUR	Painted EUR	Veneer EUR
1	BBN2226360110060.	976,49	1.100,71	1.432,02
2	BBN2226360210060.	1.974,39	2.226,69	2.899,41
3	BBN2226360310060.	2.929,20	3.302,00	4.295,92

H1220 mm

No. of bays	Item no.	Melamine EUR	Painted EUR	Veneer EUR
1	BBN2226460110060.	1.037,27	1.172,13	1.532,16
2	BBN2226460210060.	2.095,95	2.369,53	3.099,69
3	BBN2226460310060.	3.111,54	3.516,26	4.596,34

H1520 mm

No. of bays	Item no.	Melamine EUR	Painted EUR	Veneer EUR
1	BBN2226560110060.	1.051,37	1.188,75	1.555,44
2	BBN2226560210060.	2.124,15	2.402,77	3.146,25
3	BBN2226560310060.	3.153,84	3.566,12	4.666,18

H1820 mm

No. of bays	Item no.	Melamine EUR	Painted EUR	Veneer EUR
1	BBN2226660110060.	1.101,77	1.248,21	1.638,30
2	BBN2226660210060.	2.224,95	2.521,69	3.311,97
3	BBN2226660310060.	3.305,04	3.744,50	4.914,76

H2120 mm

No. of bays	Item no.	Melamine EUR	Painted EUR	Veneer EUR
1	BBN2226760110060.	1.150,45	1.305,40	1.718,50
2	BBN2226760210060.	2.322,31	2.636,07	3.472,37
3	BBN2226760310060.	3.451,08	3.916,07	5.155,36

LINGO ROUND SHELVING SYSTEM

BBN222 - 18° - STEEL BACK PANEL - ADJUSTABLE FEET - WITH TOP PLATE



LINGO ROUND SHELVING SYSTEM

BBN222 - 18° - STEEL BACK PANEL - ADJUSTABLE FEET - WITH TOP PLATE

Round shelving system with wooden end panels, intermediate panels, steel back panel and overlaying top plate.
See further description on starter, intermediate and end sections on pages 26-27.

- Prices based on steel price group 1 and wooden price group A (see Design Options pages 6-9).
- For shelves, see from page 328
- For castor frame, see page 347

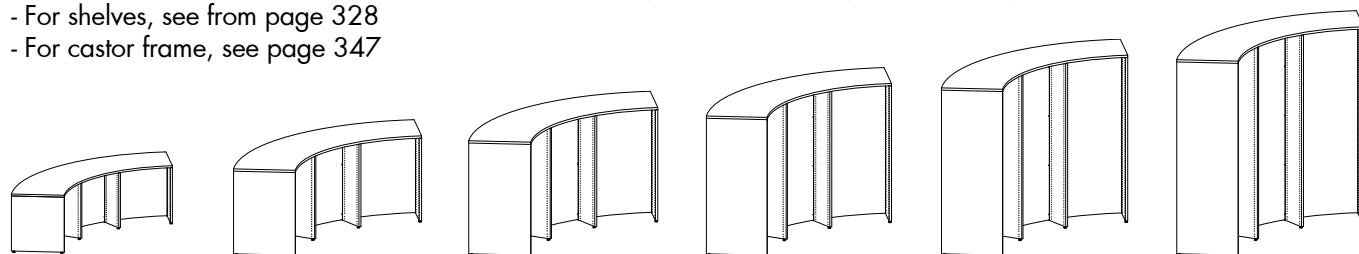

Freestanding 26° double-sided bays - H720/920/1220/1520/1820/2120 mm

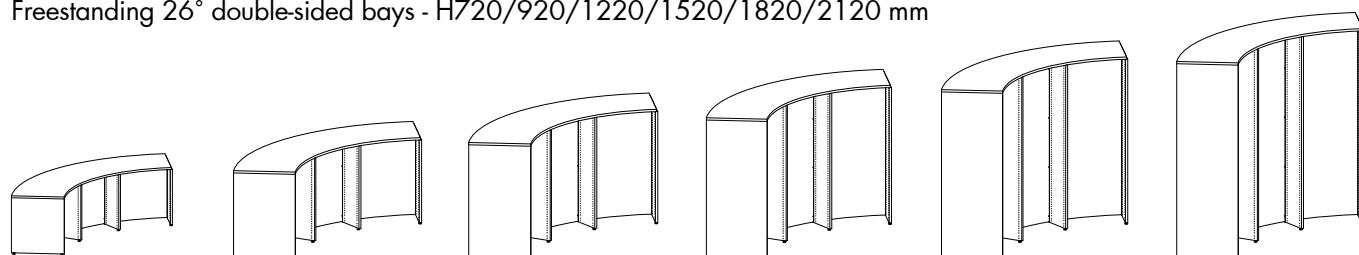

Left starter 26° double-sided bays - H720/920/1220/1520/1820/2120 mm

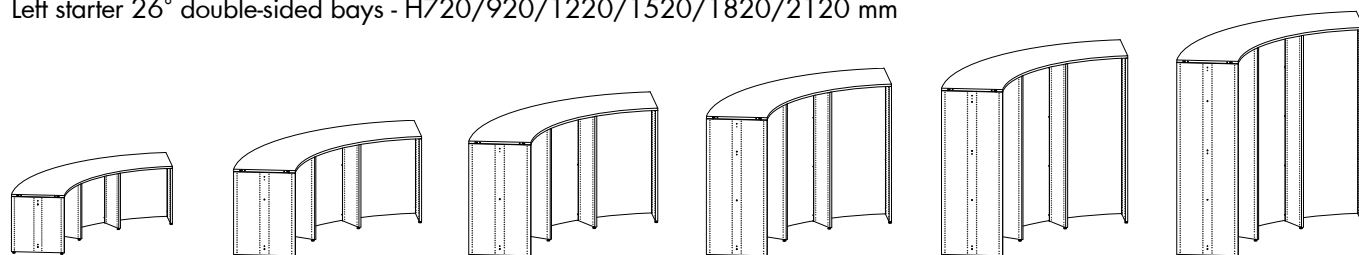

Right starter 26° double-sided bays - H720/920/1220/1520/1820/2120 mm

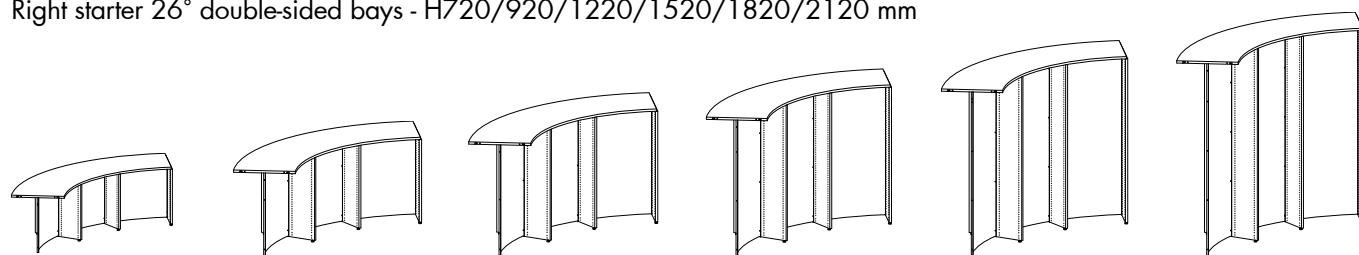

Intermediate 18° double-sided bays - H720/920/1220/1520/1820/2120 mm

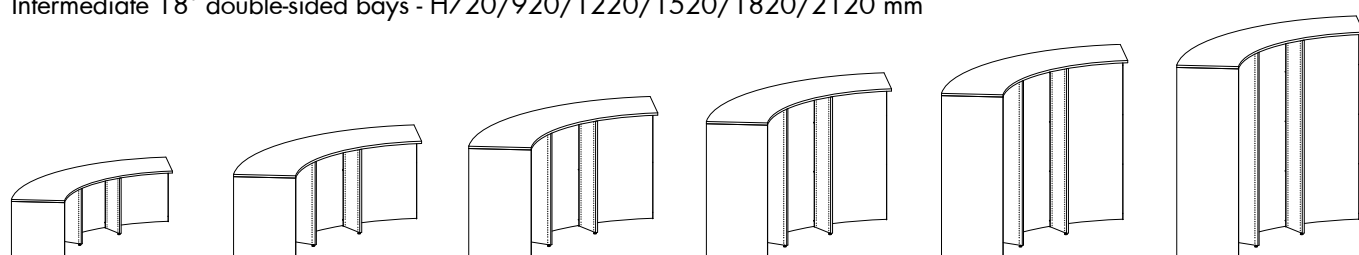

Left end 26° double-sided bays - H720/920/1220/1520/1820/2120 mm

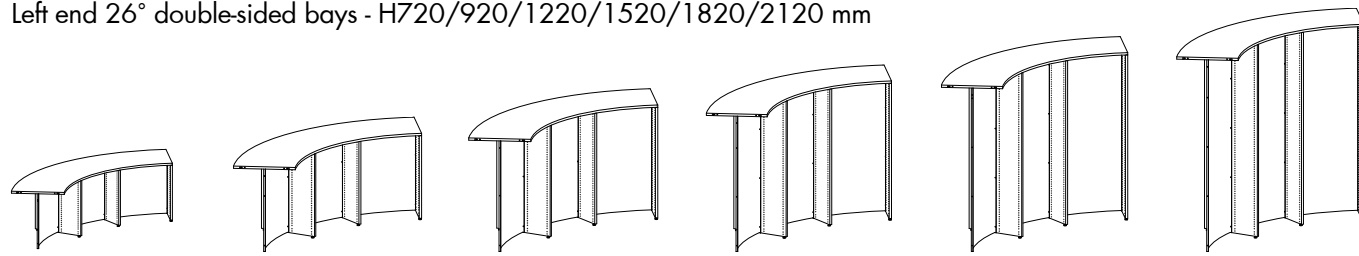

Right end 26° double-sided bays - H720/920/1220/1520/1820/2120 mm

LINGO ROUND SHELVING SYSTEM

18° - STEEL BACK PANEL - ADJUSTABLE FEET - WITH TOP PLATE - FREESTANDING SECTION

Painted and veneered Lingo Shelving Systems are FSC-certified.

H720 mm

No. of bays	Item no.	Melamine EUR	Painted EUR	Veneer EUR
1	BBN2221260110080.	1.024,62	1.169,06	1.555,43
2	BBN2221260210080.	1.909,73	2.174,27	2.880,90
3	BBN2221260310080.	2.751,88	3.128,81	4.135,62

H920 mm

No. of bays	Item no.	Melamine EUR	Painted EUR	Veneer EUR
1	BBN2221360110080.	1.169,74	1.330,14	1.758,01
2	BBN2221360210080.	2.155,81	2.444,29	3.213,17
3	BBN2221360310080.	3.098,92	3.507,77	4.597,58

H1220 mm

No. of bays	Item no.	Melamine EUR	Painted EUR	Veneer EUR
1	BBN2221460110080.	1.376,55	1.558,23	2.043,54
2	BBN2221460210080.	2.508,65	2.829,05	3.684,09
3	BBN2221460310080.	3.597,79	4.049,20	5.253,89

H1520 mm

No. of bays	Item no.	Melamine EUR	Painted EUR	Veneer EUR
1	BBN2221560110080.	1.489,87	1.676,59	2.175,22
2	BBN2221560210080.	2.721,19	3.049,15	3.924,17
3	BBN2221560310080.	3.909,55	4.371,04	5.602,37

H1820 mm

No. of bays	Item no.	Melamine EUR	Painted EUR	Veneer EUR
1	BBN2221660110080.	1.675,92	1.880,76	2.426,19
2	BBN2221660210080.	3.042,89	3.398,03	4.343,25
3	BBN2221660310080.	4.366,90	4.864,63	6.189,56

H2120 mm

No. of bays	Item no.	Melamine EUR	Painted EUR	Veneer EUR
1	BBN2221760110080.	1.858,40	2.080,26	2.671,71
2	BBN2221760210080.	3.359,17	3.739,84	4.754,09
3	BBN2221760310080.	4.816,98	5.348,75	6.765,72

LINGO ROUND SHELVING SYSTEM

18° - STEEL BACK PANEL - ADJUSTABLE FEET - WITH TOP PLATE - LEFT STARTER SECTION

Painted and veneered Lingo Shelving Systems are FSC-certified.

H720 mm

No. of bays	Item no.	Melamine EUR	Painted EUR	Veneer EUR
1	BBN2222260110080.	1.023,03	1.167,20	1.552,64
2	BBN2222260210080.	1.908,67	2.172,94	2.879,04
3	BBN2222260310080.	2.751,22	3.128,01	4.134,56

H920 mm

No. of bays	Item no.	Melamine EUR	Painted EUR	Veneer EUR
1	BBN2222360110080.	1.168,15	1.328,28	1.755,22
2	BBN2222360210080.	2.154,75	2.442,96	3.211,31
3	BBN2222360310080.	3.098,26	3.506,97	4.596,52

H1220 mm

No. of bays	Item no.	Melamine EUR	Painted EUR	Veneer EUR
1	BBN2222460110080.	1.374,96	1.556,37	2.040,75
2	BBN2222460210080.	2.507,59	2.827,72	3.682,23
3	BBN2222460310080.	3.597,13	4.048,40	5.252,83

H1520 mm

No. of bays	Item no.	Melamine EUR	Painted EUR	Veneer EUR
1	BBN2222560110080.	1.488,28	1.674,73	2.172,43
2	BBN2222560210080.	2.720,13	3.047,82	3.922,31
3	BBN2222560310080.	3.908,89	4.370,24	5.601,31

H1820 mm

No. of bays	Item no.	Melamine EUR	Painted EUR	Veneer EUR
1	BBN2222660110080.	1.674,33	1.878,90	2.423,40
2	BBN2222660210080.	3.041,83	3.396,70	4.341,39
3	BBN2222660310080.	4.366,24	4.863,83	6.188,50

H2120 mm

No. of bays	Item no.	Melamine EUR	Painted EUR	Veneer EUR
1	BBN2222760110080.	1.856,81	2.078,40	2.668,92
2	BBN2222760210080.	3.358,11	3.738,51	4.752,23
3	BBN2222760310080.	4.816,32	5.347,95	6.764,66

LINGO ROUND SHELVING SYSTEM

18° - STEEL BACK PANEL - ADJUSTABLE FEET - WITH TOP PLATE - RIGHT STARTER SECTION

Painted and veneered Lingo Shelving Systems are FSC-certified.

H720 mm

No. of bays	Item no.	Melamine EUR	Painted EUR	Veneer EUR
1	BBN2223260110080.	1.023,03	1.167,20	1.552,64
2	BBN2223260210080.	1.908,67	2.172,94	2.879,04
3	BBN2223260310080.	2.751,22	3.128,01	4.134,56

H920 mm

No. of bays	Item no.	Melamine EUR	Painted EUR	Veneer EUR
1	BBN2223360110080.	1.168,15	1.328,28	1.755,22
2	BBN2223360210080.	2.154,75	2.442,96	3.211,31
3	BBN2223360310080.	3.098,26	3.506,97	4.596,52

H1220 mm

No. of bays	Item no.	Melamine EUR	Painted EUR	Veneer EUR
1	BBN2223460110080.	1.374,96	1.556,37	2.040,75
2	BBN2223460210080.	2.507,59	2.827,72	3.682,23
3	BBN2223460310080.	3.597,13	4.048,40	5.252,83

H1520 mm

No. of bays	Item no.	Melamine EUR	Painted EUR	Veneer EUR
1	BBN2223560110080.	1.488,28	1.674,73	2.172,43
2	BBN2223560210080.	2.720,13	3.047,82	3.922,31
3	BBN2223560310080.	3.908,89	4.370,24	5.601,31

H1820 mm

No. of bays	Item no.	Melamine EUR	Painted EUR	Veneer EUR
1	BBN2223660110080.	1.674,33	1.878,90	2.423,40
2	BBN2223660210080.	3.041,83	3.396,70	4.341,39
3	BBN2223660310080.	4.366,24	4.863,83	6.188,50

H2120 mm

No. of bays	Item no.	Melamine EUR	Painted EUR	Veneer EUR
1	BBN2223760110080.	1.856,81	2.078,40	2.668,92
2	BBN2223760210080.	3.358,11	3.738,51	4.752,23
3	BBN2223760310080.	4.816,32	5.347,95	6.764,66

LINGO ROUND SHELVING SYSTEM

18° - STEEL BACK PANEL - ADJUSTABLE FEET - WITH TOP PLATE - INTERMEDIATE SECTION

Painted and veneered Lingo Shelving Systems are FSC-certified.

H720 mm

No. of bays	Item no.	Melamine EUR	Painted EUR	Veneer EUR
1	BBN2224260110080.	859,71	975,15	1.283,58
2	BBN2224260210080.	1.730,72	1.963,87	2.586,18
3	BBN2224260310080.	2.579,78	2.926,51	3.852,33

H920 mm

No. of bays	Item no.	Melamine EUR	Painted EUR	Veneer EUR
1	BBN2224360110080.	960,67	1.084,09	1.413,27
2	BBN2224360210080.	1.932,64	2.181,75	2.845,56
3	BBN2224360310080.	2.882,66	3.253,33	4.241,40

H1220 mm

No. of bays	Item no.	Melamine EUR	Painted EUR	Veneer EUR
1	BBN2224460110080.	1.106,70	1.240,76	1.598,66
2	BBN2224460210080.	2.224,70	2.495,09	3.216,34
3	BBN2224460310080.	3.320,75	3.723,34	4.797,57

H1520 mm

No. of bays	Item no.	Melamine EUR	Painted EUR	Veneer EUR
1	BBN2224560110080.	1.205,92	1.342,50	1.707,06
2	BBN2224560210080.	2.423,14	2.698,57	3.433,14
3	BBN2224560310080.	3.618,41	4.028,56	5.122,77

H1820 mm

No. of bays	Item no.	Melamine EUR	Painted EUR	Veneer EUR
1	BBN2224660110080.	1.341,57	1.487,21	1.875,17
2	BBN2224660210080.	2.694,44	2.987,99	3.769,36
3	BBN2224660310080.	4.025,36	4.462,69	5.627,10

H2120 mm

No. of bays	Item no.	Melamine EUR	Painted EUR	Veneer EUR
1	BBN2224760110080.	1.475,37	1.629,52	2.040,49
2	BBN2224760210080.	2.962,04	3.272,61	4.100,00
3	BBN2224760310080.	4.426,76	4.889,62	6.123,06

LINGO ROUND SHELVING SYSTEM

18° - STEEL BACK PANEL - ADJUSTABLE FEET - WITH TOP PLATE - LEFT END SECTION

Painted and veneered Lingo Shelving Systems are FSC-certified.

H720 mm

No. of bays	Item no.	Melamine EUR	Painted EUR	Veneer EUR
1	BBN2225260110080.	864,23	980,47	1.291,03
2	BBN2225260210080.	1.749,87	1.986,21	2.617,43
3	BBN2225260310080.	2.592,42	2.941,28	3.872,95

H920 mm

No. of bays	Item no.	Melamine EUR	Painted EUR	Veneer EUR
1	BBN2225360110080.	965,19	1.089,41	1.420,72
2	BBN2225360210080.	1.951,79	2.204,09	2.876,81
3	BBN2225360310080.	2.895,30	3.268,10	4.262,02

H1220 mm

No. of bays	Item no.	Melamine EUR	Painted EUR	Veneer EUR
1	BBN2225460110080.	1.111,22	1.246,08	1.606,11
2	BBN2225460210080.	2.243,85	2.517,43	3.247,59
3	BBN2225460310080.	3.333,39	3.738,11	4.818,19

H1520 mm

No. of bays	Item no.	Melamine EUR	Painted EUR	Veneer EUR
1	BBN2225560110080.	1.210,44	1.347,82	1.714,51
2	BBN2225560210080.	2.442,29	2.720,91	3.464,39
3	BBN2225560310080.	3.631,05	4.043,33	5.143,39

H1820 mm

No. of bays	Item no.	Melamine EUR	Painted EUR	Veneer EUR
1	BBN2225660110080.	1.346,09	1.492,53	1.882,62
2	BBN2225660210080.	2.713,59	3.010,33	3.800,61
3	BBN2225660310080.	4.038,00	4.477,46	5.647,72

H2120 mm

No. of bays	Item no.	Melamine EUR	Painted EUR	Veneer EUR
1	BBN2225760110080.	1.479,89	1.634,84	2.047,94
2	BBN2225760210080.	2.981,19	3.294,95	4.131,25
3	BBN2225760310080.	4.439,40	4.904,39	6.143,68

LINGO ROUND SHELVING SYSTEM

18° - STEEL BACK PANEL - ADJUSTABLE FEET - WITH TOP PLATE - RIGHT END SECTION

Painted and veneered Lingo Shelving Systems are FSC-certified.

H720 mm

No. of bays	Item no.	Melamine EUR	Painted EUR	Veneer EUR
1	BBN2226260110080.	864,23	980,47	1.291,03
2	BBN2226260210080.	1.749,87	1.986,21	2.617,43
3	BBN2226260310080.	2.592,42	2.941,28	3.872,95

H920 mm

No. of bays	Item no.	Melamine EUR	Painted EUR	Veneer EUR
1	BBN2226360110080.	965,19	1.089,41	1.420,72
2	BBN2226360210080.	1.951,79	2.204,09	2.876,81
3	BBN2226360310080.	2.895,30	3.268,10	4.262,02

H1220 mm

No. of bays	Item no.	Melamine EUR	Painted EUR	Veneer EUR
1	BBN2226460110080.	1.111,22	1.246,08	1.606,11
2	BBN2226460210080.	2.243,85	2.517,43	3.247,59
3	BBN2226460310080.	3.333,39	3.738,11	4.818,19

H1520 mm

No. of bays	Item no.	Melamine EUR	Painted EUR	Veneer EUR
1	BBN2226560110080.	1.210,44	1.347,82	1.714,51
2	BBN2226560210080.	2.442,29	2.720,91	3.464,39
3	BBN2226560310080.	3.631,05	4.043,33	5.143,39

H1820 mm

No. of bays	Item no.	Melamine EUR	Painted EUR	Veneer EUR
1	BBN2226660110080.	1.346,09	1.492,53	1.882,62
2	BBN2226660210080.	2.713,59	3.010,33	3.800,61
3	BBN2226660310080.	4.038,00	4.477,46	5.647,72

H2120 mm

No. of bays	Item no.	Melamine EUR	Painted EUR	Veneer EUR
1	BBN2226760110080.	1.479,89	1.634,84	2.047,94
2	BBN2226760210080.	2.981,19	3.294,95	4.131,25
3	BBN2226760310080.	4.439,40	4.904,39	6.143,68

LINGO ROUND SHELVING SYSTEM

BBN231 - 18° - STEEL BACK FRAME - CASTOR PLATE - FOR TOP SHELF



LINGO ROUND SHELVING SYSTEM

BBN231 - 18° - STEEL BACK FRAME - CASTOR PLATE - FOR TOP SHELF

Round shelving system with wooden panels, steel back frame and castor plate. To be used with top shelf.

- Prices based on steel price group 1 and wooden price group A (see Design Options pages 6-9).
- For top shelves, see from page 340
- For shelves, see from page 328

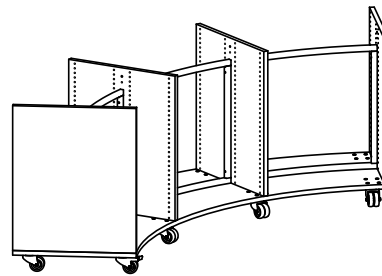
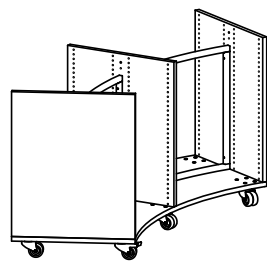
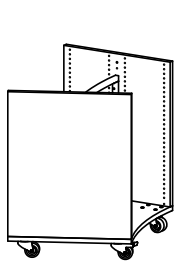

Double-sided H920 mm - 1/2/3 bays

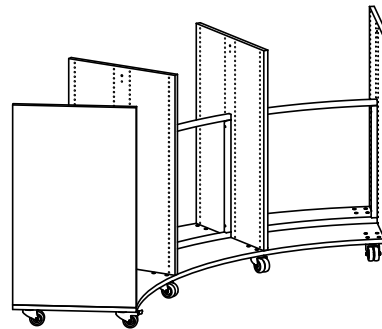
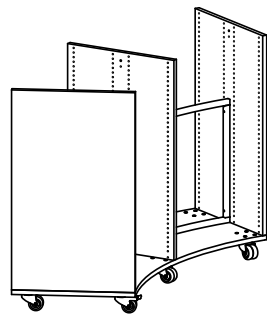
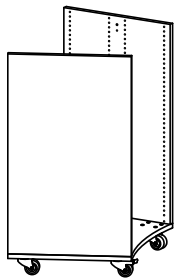

Double-sided H1220 mm - 1/2/3 bays

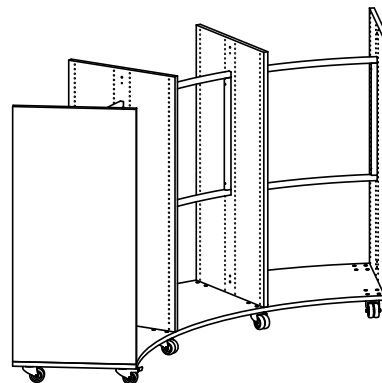
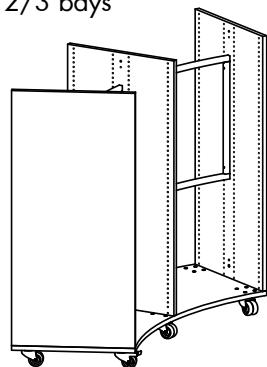
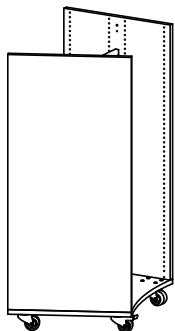

Double-sided H1520 mm - 1/2/3 bays

LINGO ROUND SHELVING SYSTEM

18° - STEEL BACK FRAME - CASTOR PLATE - FOR TOP SHELF

Painted and veneered Lingo Shelving Systems are FSC-certified.

H920 mm

No. of bays	Item no.	Melamine EUR	Painted EUR	Veneer EUR
1	BBN231136010006.	1.349,29	1.539,48	2.046,35
2	BBN231136020006.	2.468,22	2.807,90	3.713,11
3	BBN231136030006.	3.539,01	4.019,67	5.300,74

H1220 mm

No. of bays	Item no.	Melamine EUR	Painted EUR	Veneer EUR
1	BBN231146010006.	1.470,85	1.682,32	2.246,63
2	BBN231146020006.	2.650,56	3.022,16	4.013,53
3	BBN231146030006.	3.782,13	4.305,35	5.701,30

H1520 mm

No. of bays	Item no.	Melamine EUR	Painted EUR	Veneer EUR
1	BBN231156010006.	1.499,05	1.715,56	2.293,19
2	BBN231156020006.	2.692,86	3.072,02	4.083,37
3	BBN231156030006.	3.838,53	4.371,83	5.794,42

LINGO ROUND SHELVING SYSTEM

18° - STEEL BACK FRAME - CASTOR PLATE - FOR TOP SHELF



LINGO ROUND SHELVING SYSTEM

BBN231 - 18° - HIGH STEEL BACK PANEL - CASTOR PLATE - FOR TOP SHELF



LINGO ROUND SHELVING SYSTEM

BBN231 - 18° - HIGH STEEL BACK PANEL - CASTOR PLATE - FOR TOP SHELF

Round shelving system with wooden panels, high steel back panel and castor plate.
To be used with top shelves WT5 standard depth top shelf.

- Prices based on steel price group 1 and wooden price group A (see Design Options pages 6-9).
- For top shelves, see from page 340
- For shelves, see from page 328

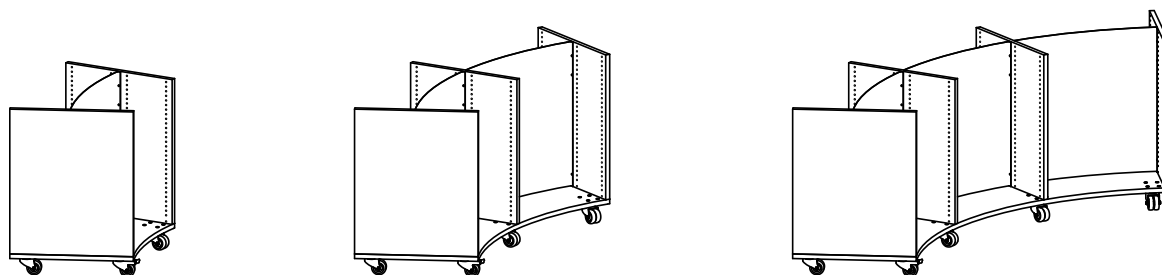

Double-sided H920 mm - 1/2/3 bays

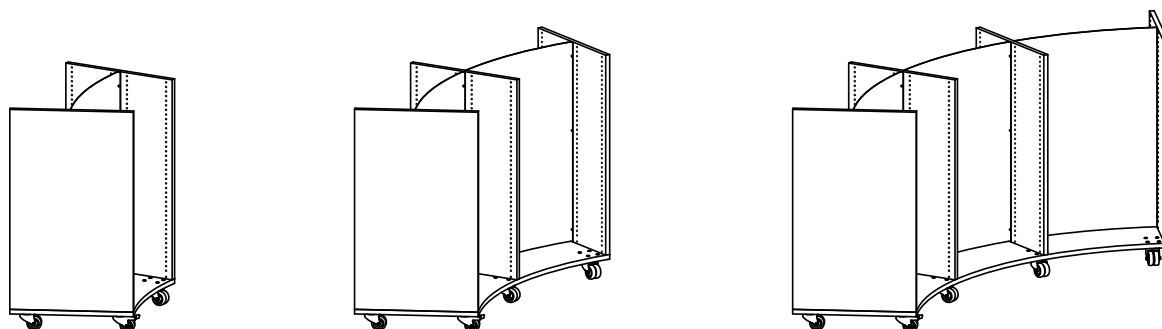

Double-sided H1220 mm - 1/2/3 bays

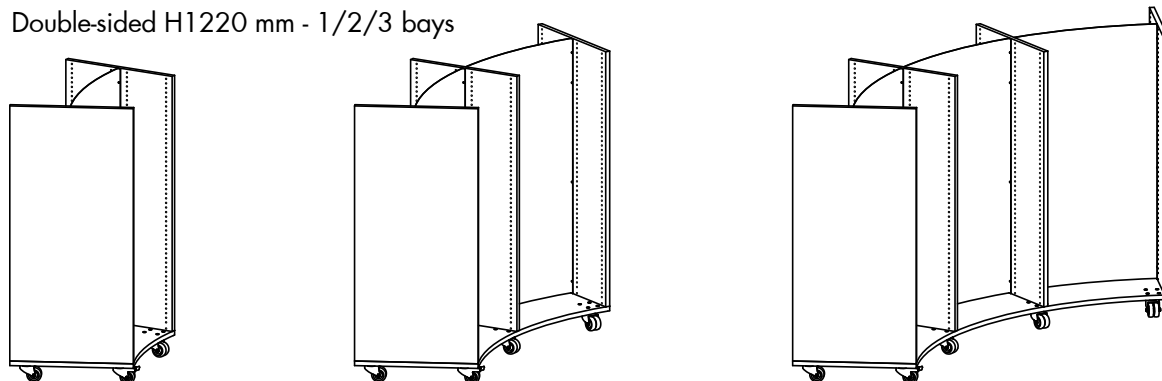

Double-sided H1520 mm - 1/2/3 bays

LINGO ROUND SHELVING SYSTEM

18° - HIGH STEEL BACK PANEL - CASTOR PLATE - FOR TOP SHELF

Painted and veneered Lingo Shelving Systems are FSC-certified.

H920 mm

No. of bays	Item no.	Melamine EUR	Painted EUR	Veneer EUR
1	BBN231136010008.	1.337,99	1.528,18	2.035,05
2	BBN231136020008.	2.445,62	2.785,30	3.690,51
3	BBN231136030008.	3.505,11	3.985,77	5.266,84

H1220 mm

No. of bays	Item no.	Melamine EUR	Painted EUR	Veneer EUR
1	BBN231146010008.	1.544,80	1.756,27	2.320,58
2	BBN231146020008.	2.798,46	3.170,06	4.161,43
3	BBN231146030008.	4.003,98	4.527,20	5.923,15

H1520 mm

No. of bays	Item no.	Melamine EUR	Painted EUR	Veneer EUR
1	BBN231156010008.	1.658,12	1.874,63	2.452,26
2	BBN231156020008.	3.011,00	3.390,16	4.401,51
3	BBN231156030008.	4.315,74	4.849,04	6.271,63

LINGO ROUND SHELVING SYSTEM

18° - HIGH STEEL BACK PANEL - CASTOR PLATE - FOR TOP SHELF

LINGO ROUND SHELVING SYSTEM

BBN231 - 18° - LOW STEEL BACK PANEL - CASTOR PLATE - FOR TOP SHELF



LINGO ROUND SHELVING SYSTEM

BBN231 - 18° - LOW STEEL BACK PANEL - CASTOR PLATE - FOR TOP SHELF

Round shelving system with wooden panels, low steel back panel and castor plate.
To be used with top shelves WT5 full depth and WT5 double-sided top shelf.

- Prices based on steel price group 1 and wooden price group A (see Design Options pages 6-9).
- For top shelves, see from page 340
- For shelves, see from page 328
- For slat panels, see from page 351 (note slate panel replaces outer panel)

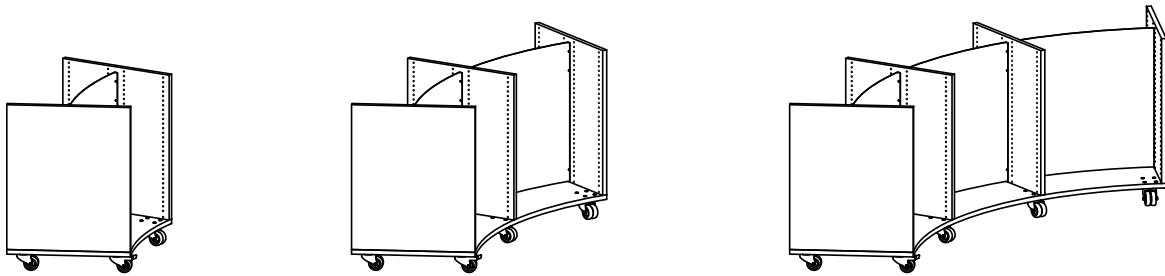

Double-sided H920 mm - 1/2/3 bays

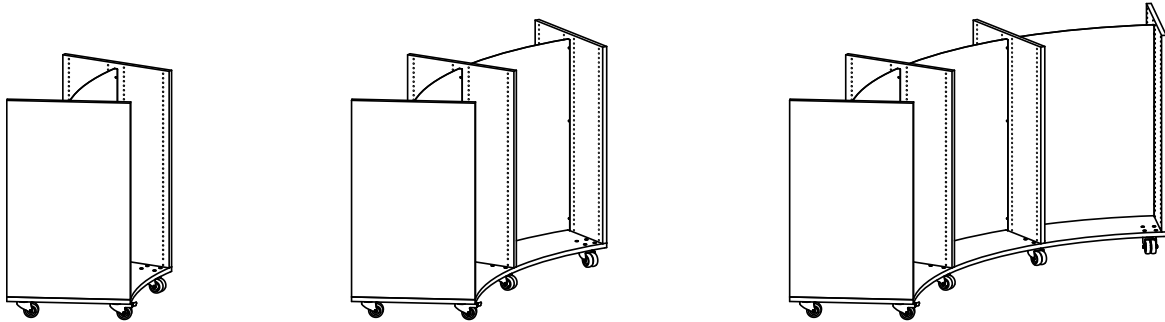

Double-sided H1220 mm - 1/2/3 bays

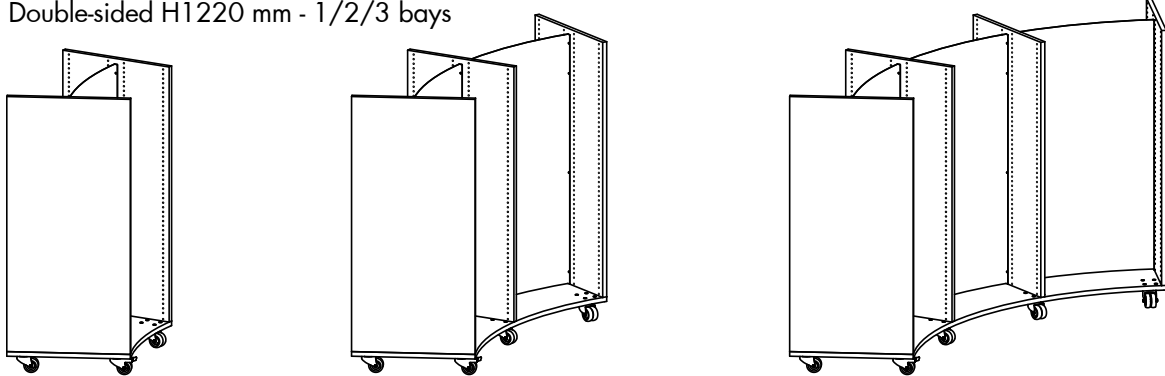

Double-sided H1520 mm - 1/2/3 bays

LINGO ROUND SHELVING SYSTEM

18° - LOW STEEL BACK PANEL - CASTOR PLATE - FOR TOP SHELF

Painted and veneered Lingo Shelving Systems are FSC-certified.

H920 mm

No. of bays	Item no.	Melamine EUR	Painted EUR	Veneer EUR
1	BBN231136010007.	1.337,99	1.528,18	2.035,05
2	BBN231136020007.	2.445,62	2.785,30	3.690,51
3	BBN231136030007.	3.505,11	3.985,77	5.266,84

H1220 mm

No. of bays	Item no.	Melamine EUR	Painted EUR	Veneer EUR
1	BBN231146010007.	1.544,80	1.756,27	2.320,58
2	BBN231146020007.	2.798,46	3.170,06	4.161,43
3	BBN231146030007.	4.003,98	4.527,20	5.923,15

H1520 mm

No. of bays	Item no.	Melamine EUR	Painted EUR	Veneer EUR
1	BBN231156010007.	1.658,12	1.874,63	2.452,26
2	BBN231156020007.	3.011,00	3.390,16	4.401,51
3	BBN231156030007.	4.315,74	4.849,04	6.271,63

LINGO ROUND SHELVING SYSTEM

18° - LOW STEEL BACK PANEL - CASTOR PLATE - FOR TOP SHELF

LINGO ROUND SHELVING SYSTEM

BBN232 - 18° - STEEL BACK FRAME - CASTOR PLATE - WITH OVERLAYING TOP PLATE



LINGO ROUND SHELVING SYSTEM

BBN232 - 18° - STEEL BACK FRAME - CASTOR PLATE - WITH OVERLAYING TOP PLATE

Round shelving system with wooden panels, steel back frame, castor plate and overlaying top plate.

- Prices based on steel price group 1 and wooden price group A (see Design Options pages 6-9).
- For shelves, see from page 328

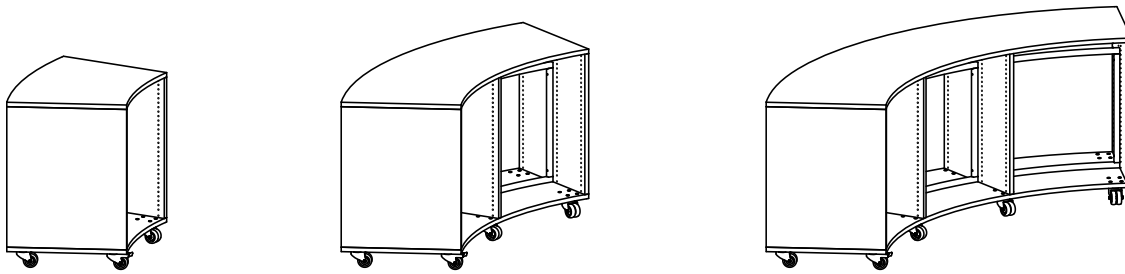

Double-sided H920 mm - 1/2/3 bays

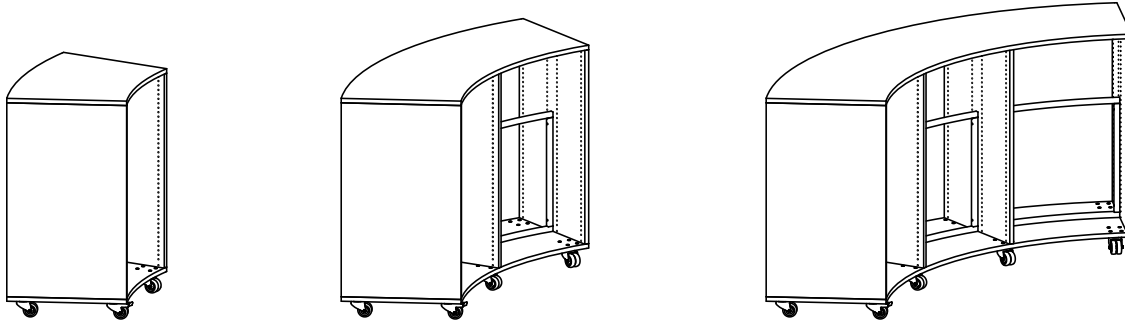

Double-sided H1220 mm - 1/2/3 bays

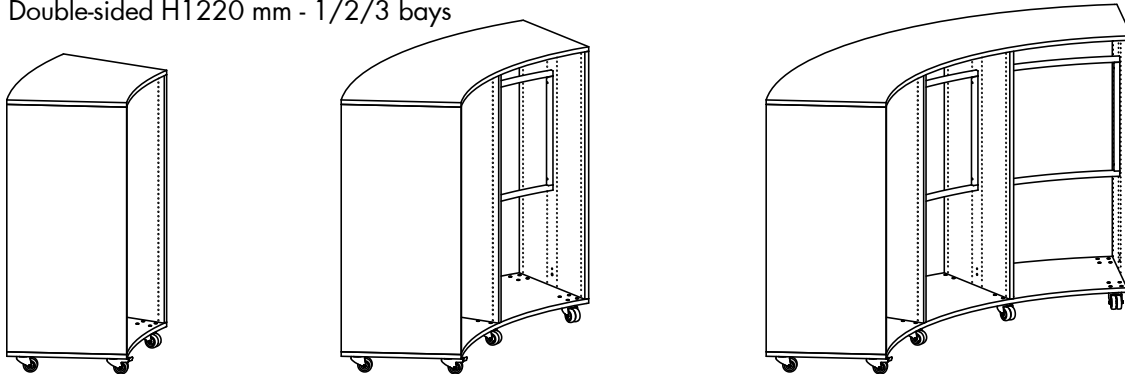

Double-sided H1520 mm - 1/2/3 bays

LINGO ROUND SHELVING SYSTEM

18° - STEEL BACK FRAME - CASTOR PLATE - WITH OVERLAYING TOP PLATE

Painted and veneered Lingo Shelving Systems are FSC-certified.

H920 mm

No. of bays	Item no.	Melamine EUR	Painted EUR	Veneer EUR
1	BBN232136011006.	1.851,76	2.130,53	2.874,01
2	BBN232136021006.	3.492,45	4.012,88	5.400,08
3	BBN232136031006.	5.042,04	5.787,91	7.776,27

H1220 mm

No. of bays	Item no.	Melamine EUR	Painted EUR	Veneer EUR
1	BBN232146011006.	1.973,32	2.273,37	3.074,29
2	BBN232146021006.	3.674,79	4.227,14	5.700,50
3	BBN232146031006.	5.285,16	6.073,59	8.176,83

H1520 mm

No. of bays	Item no.	Melamine EUR	Painted EUR	Veneer EUR
1	BBN232156011006.	2.001,52	2.306,61	3.120,85
2	BBN232156021006.	3.717,09	4.277,00	5.770,34
3	BBN232156031006.	5.341,56	6.140,07	8.269,95

LINGO ROUND SHELVING SYSTEM

18° - STEEL BACK FRAME - CASTOR PLATE - WITH OVERLAYING TOP PLATE

LINGO ROUND SHELVING SYSTEM

BBN232 - 18° - STEEL BACK PANEL - CASTOR PLATE - WITH OVERLAYING TOP PLATE



LINGO ROUND SHELVING SYSTEM

BBN232 - 18° - STEEL BACK PANEL - CASTOR PLATE - WITH OVERLAYING TOP PLATE

Round shelving system with wooden panels, steel back panel, castor plate and overlaying top plate.

- Prices based on steel price group 1 and wooden price group A (see Design Options pages 6-9).
- For shelves, see from page 328

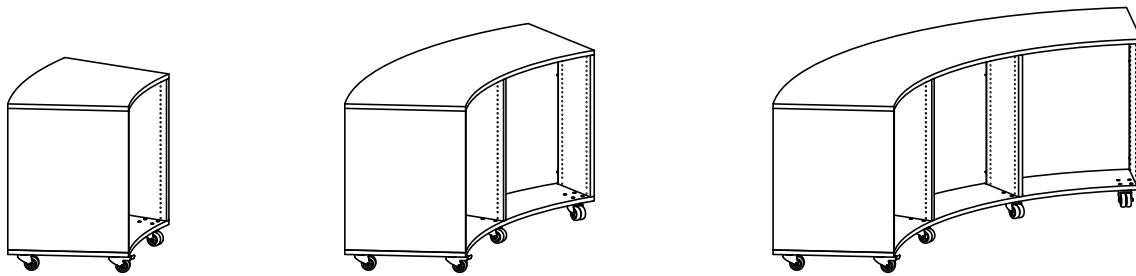

Double-sided H920 mm - 1/2/3 bays

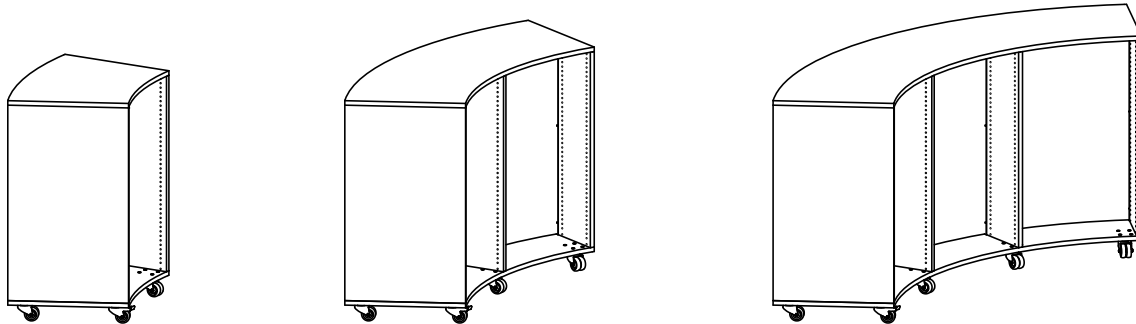

Double-sided H1220 mm - 1/2/3 bays

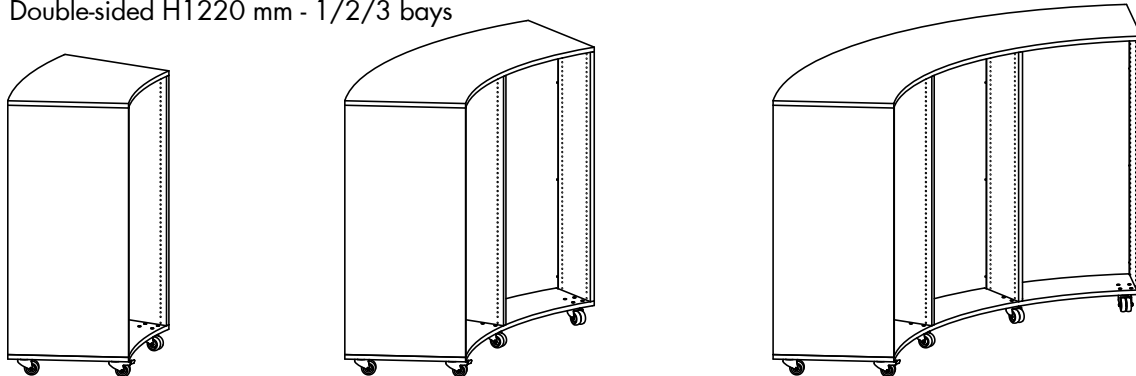

Double-sided H1520 mm - 1/2/3 bays

LINGO ROUND SHELVING SYSTEM

18° - STEEL BACK PANEL - CASTOR PLATE - WITH OVERLAYING TOP PLATE

Painted and veneered Lingo Shelving Systems are FSC-certified.

H920 mm

No. of bays	Item no.	Melamine EUR	Painted EUR	Veneer EUR
1	BBN232136011008.	1.840,46	2.119,23	2.862,71
2	BBN232136021008.	3.469,85	3.990,28	5.377,48
3	BBN232136031008.	5.008,14	5.754,01	7.742,37

H1220 mm

No. of bays	Item no.	Melamine EUR	Painted EUR	Veneer EUR
1	BBN232146011008.	2.047,27	2.347,32	3.148,24
2	BBN232146021008.	3.822,69	4.375,04	5.848,40
3	BBN232146031008.	5.507,01	6.295,44	8.398,68

H1520 mm

No. of bays	Item no.	Melamine EUR	Painted EUR	Veneer EUR
1	BBN232156011008.	2.160,59	2.465,68	3.279,92
2	BBN232156021008.	4.035,23	4.595,14	6.088,48
3	BBN232156031008.	5.818,77	6.617,28	8.747,16

LINGO ROUND SHELVING SYSTEM

18° - STEEL BACK PANEL - CASTOR PLATE - WITH OVERLAYING TOP PLATE



COMPONENTS

CHECK LIST

When constructing your round shelving, there are many factors to be taken into consideration and most importantly, you must remember to order all parts. Below you will find a check list of components you need to consider when constructing your round wooden shelving.

SHELVES

The following factors are all to be considered before choosing the shelf:

- steel or wooden shelf
- steel or wooden topshelf, or wooden overlaying top plate

CASTORS

Extra components to complete the function and design of shelving:

- castor frame with castors
- castor plate with castors
- plinth

PANELS

The following factors are all to be considered before choosing the panel:

- height (720/920/1220/1520/1820/2120 mm)
- stationary or mobile (adjustable feet/castor frame/castor plate)
- top (top shelf/overlaying top plate)

CONNECTION ELEMENTS

To support the shelving and determine the design of shelving system, you must choose between one of the 2 connection elements. Note that if you wish to combine straight and round shelving and maintain the same design, you must use the steel back frame.:

- steel back frame/ steel back panel

SHELVES

S5 - ROUND STEEL SHELVES

See below for overview of standard round steel shelves:

S5 - ROUND STEEL SHELF WITH STEEL BACKEDGE

Details:

- 26°/18°
- Inner & outer
- Depth 300 mm
- Steel backedge H47 mm
- Steel brackets
- Max. weight 80 kg.

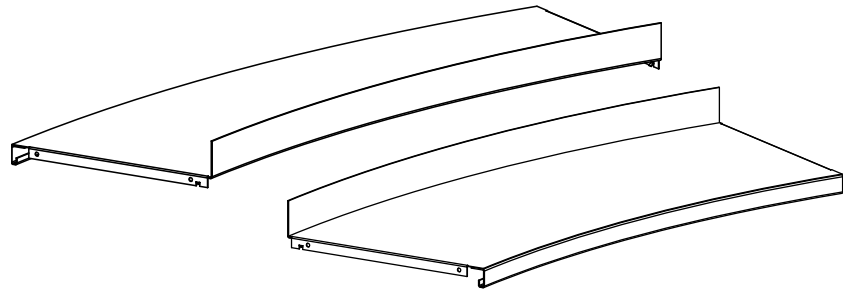

Use with:

- WT5 - wooden top shelf
- WO5 - wooden overlaying top plate

Note:

- Steel shelves placed at the bottom, must always be fixed with screws.

SHELVES

S6 - ROUND STEEL SHELVES

See below for overview of standard round steel shelves:

S6 - ROUND STEEL SHELF

Details:

- 26°/18°
- Inner & outer
- Depth 300 mm
- Steel brackets
- Max. weight 80 kg.

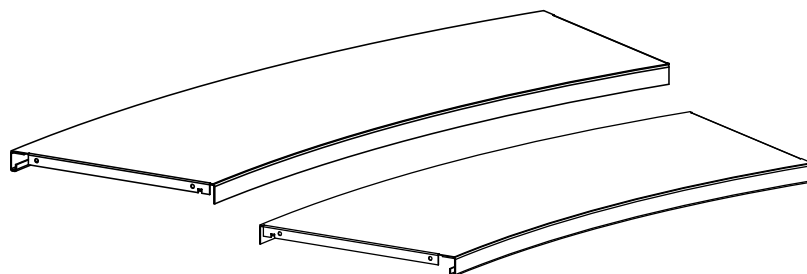

Use with:

- WT5 - wooden top shelf
- WO5 - wooden overlaying top plate

Note:

- Steel shelves placed at the bottom, must always be fixed with screws.

SHELVES

S5 - ROUND STEEL SHELF WITH STEEL BACKEDGE

S5 - intermediate, round, steel shelf with steel backedge and steel brackets - inner

Steel backedge 47 mm. With brackets and fittings.	Degree	Shelf depth mm	Item no.	Price EUR
	26	300	BBN290611	232,76
	18	300	BBN290811	232,76

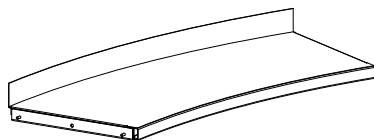

S5 - intermediate, round, steel shelf with steel backedge and steel brackets - outer

Steel backedge 47 mm. With brackets, fittings and shelf strengthner.	Degree	Shelf depth mm	Item no.	Price EUR
	26	300	BBN290621	263,88
	18	300	BBN290821	263,88

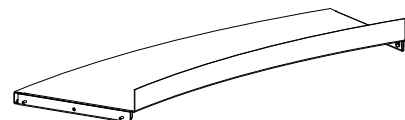

SHELVES

S5 - ROUND STEEL SHELF WITH STEEL BACKEDGE & BRACKETS

S5 - intermediate, round, steel shelf with steel backedge - inner

Steel backedge 47 mm.
Brackets to be ordered
separately, see below.

Degree	Shelf depth mm
26	300
18	300

Item no.	Price EUR
BN26561	214,40
BN26581	214,40

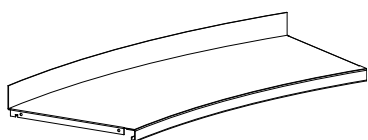

S5 - intermediate, round, steel shelf with steel backedge - outer

Steel backedge 47 mm.
With shelf strengthner.
Brackets to be ordered
separately, see below.

Degree	Shelf depth mm
26	300
18	300

Item no.	Price EUR
BN26562	245,52
BN26582	245,52

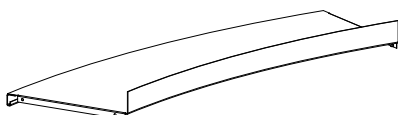

Steel bracket - for S5 & S6

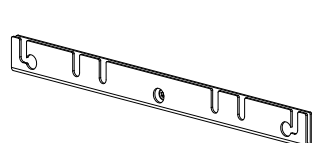

Shelf depth mm
300

Item no.	Price EUR
BN0843	9,18

SHELVES

S6 - ROUND STEEL SHELF

S6 - intermediate, round, steel shelf with steel brackets - inner

With brackets and fittings.	Degree	Shelf depth mm	Item no.	Price EUR
	26	300	BBN290612	232,76
	18	300	BBN290812	232,76

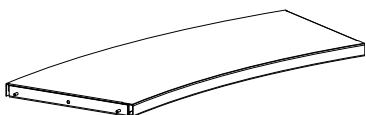

S6 - intermediate, round, steel shelf with steel brackets - outer

With brackets, fittings and shelf strengthenner.	Degree	Shelf depth mm	Item no.	Price EUR
	26	300	BBN290622	263,88
	18	300	BBN290822	263,88

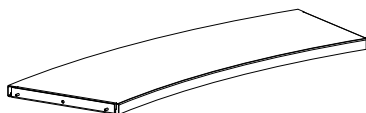

SHELVES

S6 - ROUND STEEL SHELF & BRACKETS

S6 - intermediate, round, steel shelf - inner

Brackets to be ordered separately, see below.

Degree	Shelf depth mm
26	300
18	300

Item no.	Price EUR
BN26661	214,40
BN26681	214,40

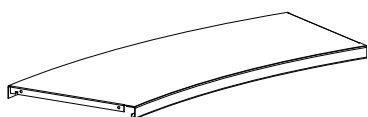

S6 - intermediate, round, steel shelf - outer

With shelf strengthner.
Brackets to be ordered separately, see below.

Degree	Shelf depth mm
26	300
18	300

Item no.	Price EUR
BN26662	245,52
BN26682	245,52



Steel bracket - for S5 & S6

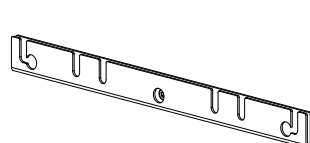

Shelf depth mm
300

Item no.	Price EUR
BN0843	9,18

SHELVES

W5 & W6 - ROUND WOODEN SHELVES

See below for overview of standard round wooden shelves:

W5 - ROUND WOODEN SHELF WITH H47 MM STEEL BACKEDGE

Details:

- 26°/18°
- Depth 300 mm
- Painted/veneer
- Steel backedge H47 mm
- Snapfix for intermediate shelf/
snapfix and screws for bottom shelf
- Max. weight 80 kg.
- Blockboard

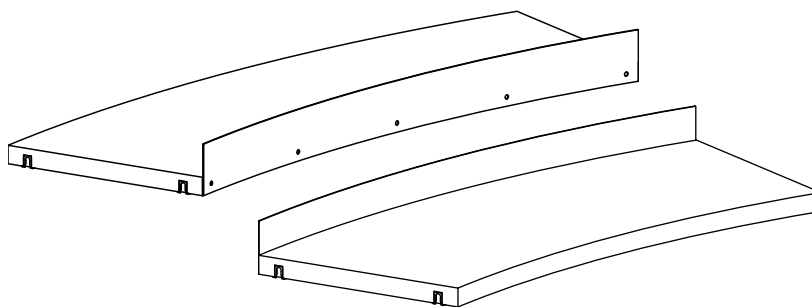

Use with:

- S6 - round steel top shelf
- WT5 - round wooden top shelf
- WO5 - round wooden overlaying top plate

Note:

- Wooden shelves placed at the bottom, must always be fixed with snapfix and screws.

W6 - ROUND WOODEN SHELF

Details:

- 26°/18°
- Depth 300 mm
- Painted/veneer
- No backedge
- Snapfix for intermediate shelf/
snapfix and screws for bottom shelf
- Max. weight 80 kg.
- Blockboard

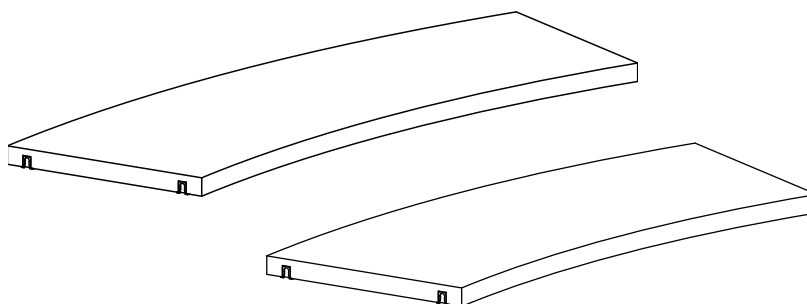

Use with:

- S6 - round steel top shelf
- WT5 - wooden top shelf
- WO5 - wooden overlaying top plate

Note:

- Wooden shelves placed at the bottom, must always be fixed with snapfix and screws.

SHELVES

W7 & W8 - ROUND WOODEN SHELVES

See below for overview of standard round wooden shelves:

W7 - ROUND WOODEN SHELF WITH H47 MM STEEL BACKEDGE

Details:

- 26°/18°
- Depth 300 mm
- Melamine
- Steel backedge H47 mm
- Snapfix for intermediate shelf/
snapfix and screws for bottom shelf
- Max. weight 60 kg.
- Particleboard

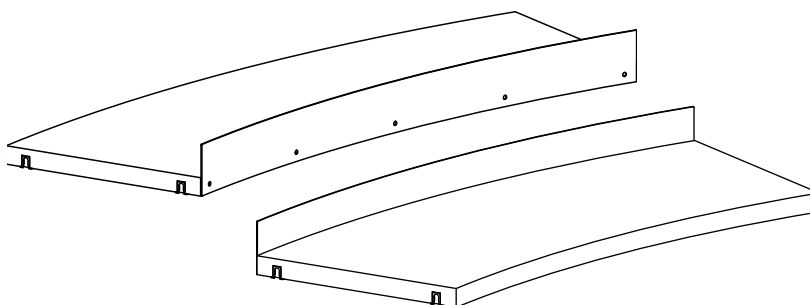

Use with:

- S6 - round steel top shelf
- WT7 - wooden top shelf
- WO5 - wooden overlaying top plate

Note:

- Wooden shelves placed at the bottom, must always be fixed with snapfix and screws.

W8 - ROUND WOODEN SHELF

Details:

- 26°/18°
- Depth 300 mm
- Melamine
- No backedge
- Snapfix for intermediate shelf/
snapfix and screws for bottom shelf
- Max. weight 60 kg.
- Particleboard

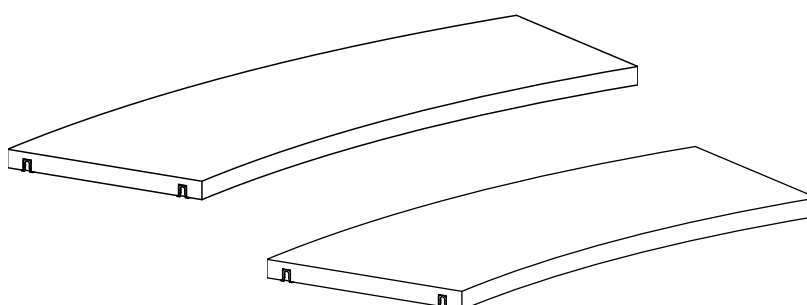

Use with:

- S6 - round steel top shelf
- WT7 - wooden top shelf
- WO5 - wooden overlaying top plate

Note:

- Wooden shelves placed at the bottom, must always be fixed with snapfix and screws.

SHELVES

W5 - ROUND WOODEN SHELF WITH H47 MM BACKEDGE AND COMPONENTS

Painted and veneered shelves are FSC-certified.

W5 - intermediate, round wooden shelf with steel backedge and snapfix - inner

H47 mm steel backedge. Blockboard. Incl. fittings (snapfix).	Degree	Shelf depth mm	Item no.	Melamine EUR	Painted EUR	Veneer EUR
	26	300	BN267611.ZZZZZ3	-	262,54	364,15
	18	300	BN267811.ZZZZZ3	-	262,54	364,15

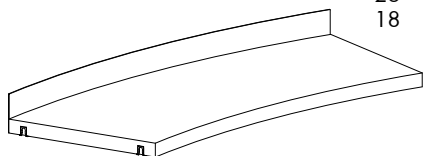

W5 - intermediate, round wooden shelf with steel backedge and snapfix - outer

H47 mm steel backedge. Blockboard. Incl. fittings (snapfix).	Degree	Shelf depth mm	Item no.	Melamine EUR	Painted EUR	Veneer EUR
	26	300	BN267621.ZZZZZ3	-	314,28	436,51
	18	300	BN267821.ZZZZZ3	-	314,28	436,51

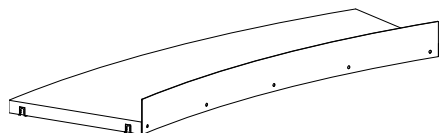

W5 - bottom, round wooden shelf with steel backedge, snapfix and screws - inner

H47 mm steel backedge. Blockboard. Incl. fittings (snapfix and screws).	Degree	Shelf depth mm	Item no.	Melamine EUR	Painted EUR	Veneer EUR
	26	300	BN267611.ZZZZZ2	-	262,54	364,15
	18	300	BN267811.ZZZZZ2	-	262,54	364,15

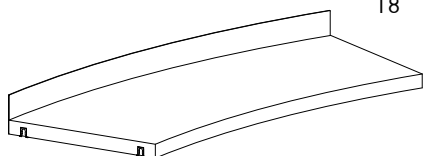

W5 - bottom, round wooden shelf with steel backedge, snapfix and screws - outer

H47 mm steel backedge. Blockboard. Incl. fittings (snapfix and screws).	Degree	Shelf depth mm	Item no.	Melamine EUR	Painted EUR	Veneer EUR
	26	300	BN267621.ZZZZZ2	-	314,28	436,51
	18	300	BN267821.ZZZZZ2	-	314,28	436,51

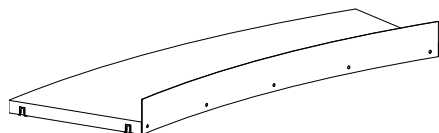

SHELVES

W6 - ROUND WOODEN SHELF AND COMPONENTS

Painted and veneered shelves are FSC-certified.

W6 - intermediate, round wooden shelf without backedge, with snapfix - inner

Blockboard. Incl. fittings (snapfix).	Degree	Shelf depth mm	Item no.	Melamine EUR	Painted EUR	Veneer EUR
	26	300	BN267610.ZZZZZ3	-	235,28	329,44
	18	300	BN267810.ZZZZZ3	-	235,28	329,44

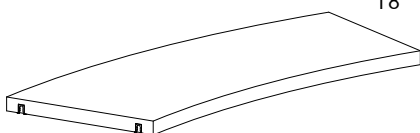

W6 - intermediate, round wooden shelf without backedge, with snapfix - outer

Blockboard. Incl. fittings (snapfix).	Degree	Shelf depth mm	Item no.	Melamine EUR	Painted EUR	Veneer EUR
	26	300	BN267620.ZZZZZ3	-	287,01	401,79
	18	300	BN267820.ZZZZZ3	-	287,01	401,79

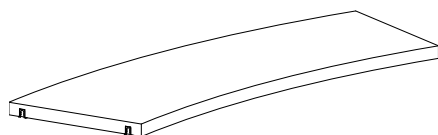

W6 - bottom, round wooden shelf without backedge, with snapfix and screws - inner

Blockboard. Incl. fittings (snapfix and screws).	Degree	Shelf depth mm	Item no.	Melamine EUR	Painted EUR	Veneer EUR
	26	300	BN267610.ZZZZZ2	-	235,28	329,44
	18	300	BN267810.ZZZZZ2	-	235,28	329,44

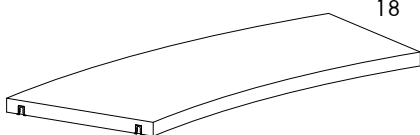

W6 - bottom, round wooden shelf without backedge, with snapfix and screws - outer

Blockboard. Incl. fittings (snapfix and screws).	Degree	Shelf depth mm	Item no.	Melamine EUR	Painted EUR	Veneer EUR
	26	300	BN267620.ZZZZZ2	-	287,01	401,79
	18	300	BN267820.ZZZZZ2	-	287,01	401,79

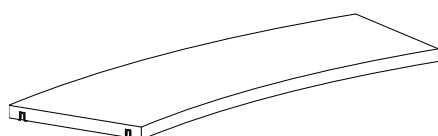

SHELVES

W7 - ROUND WOODEN SHELF WITH H47 MM BACKEDGE & COMPONENTS

W7 - intermediate, round wooden shelf with steel backedge and snapfix - inner

H47 mm steel backedge. Particleboard. Incl. fittings (snapfix)	Degree	Shelf depth mm	Item no.	Melamine EUR	Painted EUR	Veneer EUR
	26	300	BN270611.ZZZ3	223,17	-	-
	18	300	BN270811.ZZZ3	223,17	-	-

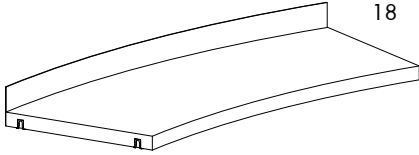

W7 - intermediate, round wooden shelf with steel backedge and snapfix - outer

H47 mm steel backedge. Particleboard. Incl. fittings (snapfix)	Degree	Shelf depth mm	Item no.	Laminate EUR	Painted EUR	Veneer EUR
	26	300	BN270621.ZZZ3	267,06	-	-
	18	300	BN270821.ZZZ3	267,06	-	-

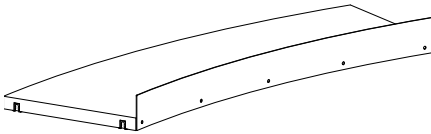

W7 - bottom, round wooden shelf with steel backedge, snapfix and screws - inner

H47 mm steel backedge. Particleboard Incl. fittings (snapfix)	Degree	Shelf depth mm	Item no.	Melamine EUR	Painted EUR	Veneer EUR
	26	300	BN270611.ZZZ2	223,17	-	-
	18	300	BN270811.ZZZ2	223,17	-	-

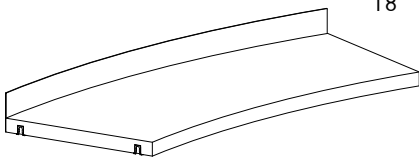

W7 - bottom, round wooden shelf with steel backedge, snapfix and screws - outer

H47 mm steel backedge. Particleboard. Incl. fittings (snapfix)	Degree	Shelf depth mm	Item no.	Laminate EUR	Painted EUR	Veneer EUR
	26	300	BN270621.ZZZ2	267,06	-	-
	18	300	BN270821.ZZZ2	267,06	-	-

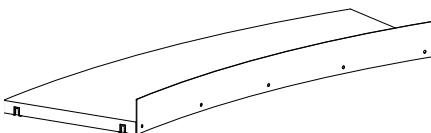

SHELVES

W8 - ROUND WOODEN SHELF

W8 - intermediate, round wooden shelf without backedge, with snapfix - inner

Particleboard. Incl. fittings (snapfix).	Degree	Shelf depth mm	Item no.	Melamine EUR	Painted EUR	Veneer EUR
	26	300	BN270610.ZZZ3	200,03	-	-
	18	300	BN270810.ZZZ3	200,03	-	-

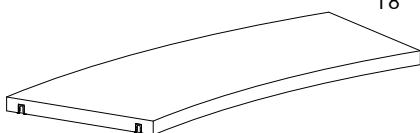

W8 - intermediate, round wooden shelf without backedge, with snapfix - outer

Particleboard. Incl. fittings (snapfix).	Degree	Shelf depth mm	Item no.	Laminate EUR	Painted EUR	Veneer EUR
	26	300	BN270620.ZZZ3	243,92	-	-
	18	300	BN270820.ZZZ3	243,92	-	-

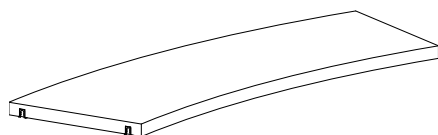

W8 - bottom, round wooden shelf without backedge, with snapfix and screws - inner

Particleboard. Incl. fittings (snapfix and screws).	Degree	Shelf depth mm	Item no.	Melamine EUR	Painted EUR	Veneer EUR
	26	300	BN270610.ZZZ2	200,03	-	-
	18	300	BN270810.ZZZ2	200,03	-	-

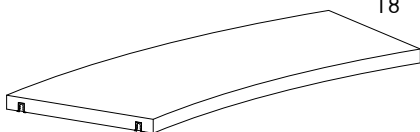

W8 - bottom, round wooden shelf without backedge, with snapfix and screws - outer

Particleboard. Incl. fittings (snapfix and screws).	Degree	Shelf depth mm	Item no.	Laminate EUR	Painted EUR	Veneer EUR
	26	300	BN270620.ZZZ2	243,92	-	-
	18	300	BN270820.ZZZ2	243,92	-	-

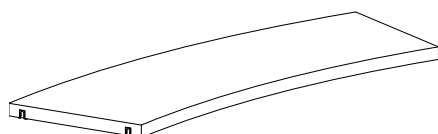

SHELVES

WT5 - ROUND WOODEN TOP SHELVES

Choose between a wooden top shelf (placed in between the wooden panels) or a wooden overlaying top plate (placed on top of the panels).

WT5 - ROUND WOODEN TOP SHELF

Details:

- 26°/18°
- Painted/veneer
- Single-sided standard depth inner & outer
Double-sided
- Snapfix and screws
- Max. weight 25 kg
- Particleboard

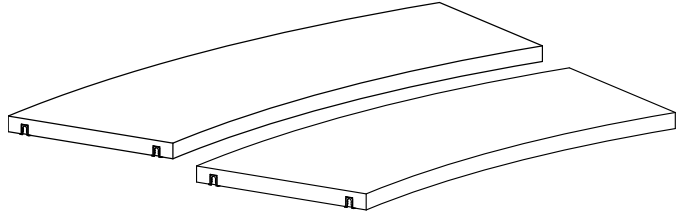

Use with:

- S5 - round steel shelves
- W5/W6/W7/W8 - round wooden shelves
- WP1/WP5 - wooden panel
- SBP5/SBP7 - round steel back panel for standard depth
SBP6/SBP8 - round steel back panel for double-sided

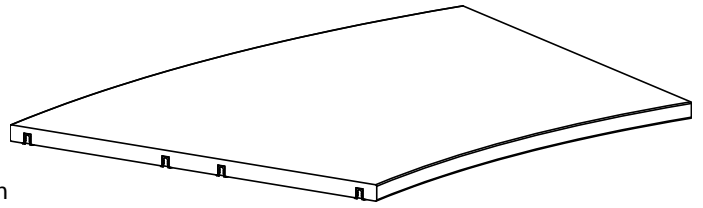

Note:

- Wooden top shelves must always be fixed with snapfix and screws.

SHELVES

WT7 - ROUND WOODEN TOP SHELVES

Choose between a wooden top shelf (placed in between the wooden panels) or a wooden overlaying top plate (placed on top of the panels).

WT7 - ROUND WOODEN TOP SHELF

Details:

- 26°/18°
- Melamine
- Single-sided standard depth inner & outer
Double-sided
- Snapfix and screws
- Max. weight 25 kg.
- Particleboard

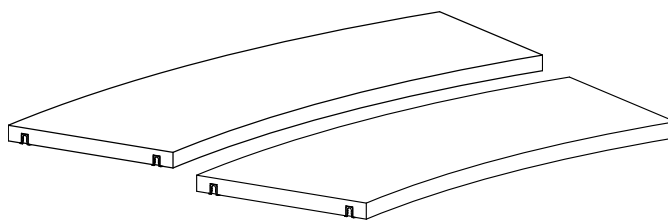

Use with:

- S5 - round steel shelves
- W5/W5/W7/W8 - round wooden shelves
- WP1/WP5 - wooden panel
- SBP5/SBP7 - round steel back panel for standard depth
SBP6/SBP8 - round steel back panel for double-sided

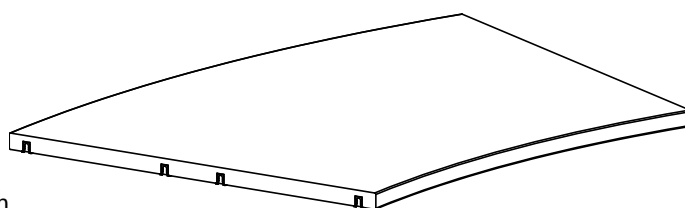

Note:

- Wooden top shelves must always be fixed with snapfix and screws.

SHELVES

WT5 - ROUND WOODEN TOP SHELF - PAINTED/VENEER

Painted and veneered shelves are FSC-certified.

WT5 - round single-sided wooden top shelf - standard depth - inner

Particleboard. Incl. fittings (snapfix and screws).	Degree	Shelf depth mm	Item no.	Melamine EUR	Painted EUR	Veneer EUR
	26	300	BN276561.	-	235,28	329,44
	18	300	BN276581.	-	235,28	329,44

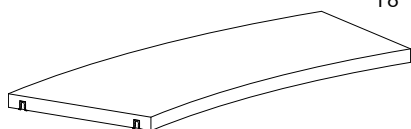

WT5 - round single-sided wooden top shelf - standard depth - outer

Particleboard. Incl. fittings (snapfix and screws).	Degree	Shelf depth mm	Item no.	Melamine EUR	Painted EUR	Veneer EUR
	26	300	BN276562.	-	287,01	401,79
	18	300	BN276582.	-	287,01	401,79

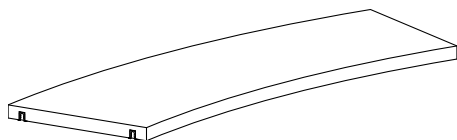

WT5 - round double-sided wooden top shelf

Particleboard. Incl. fittings (snapfix and screws).	Degree	Shelf depth mm	Item no.	Melamine EUR	Painted EUR	Veneer EUR
	26	300	BN276660.	-	522,29	731,10
	18	300	BN276680.	-	522,29	731,10

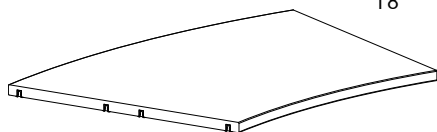

SHELVES

WT7 - ROUND WOODEN TOP SHELF - MELAMINE

WT7 - round single-sided wooden top shelf - standard depth - inner

Particleboard. Incl. fittings (snapfix and screws).	Degree	Shelf depth mm	Item no.	Melamine EUR	Painted EUR	Veneer EUR
	26	300	BN277561.	200,03	-	-
	18	300	BN277581.	200,03	-	-

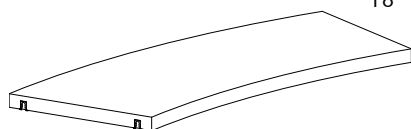

WT7 - round single-sided wooden top shelf - standard depth outer

Particleboard. Incl. fittings (snapfix and screws).	Degree	Shelf depth mm	Item no.	Melamine EUR	Painted EUR	Veneer EUR
	26	300	BN277562.	243,92	-	-
	18	300	BN277582.	243,92	-	-

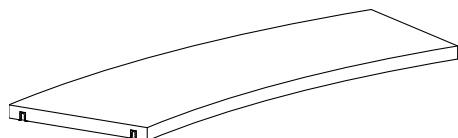

WT7 - round double-sided wooden top shelf

Particleboard. Incl. fittings (snapfix and screws).	Degree	Shelf depth mm	Item no.	Melamine EUR	Painted EUR	Veneer EUR
	26	300	BN277660.	443,82	-	-
	18	300	BN277680.	443,82	-	-

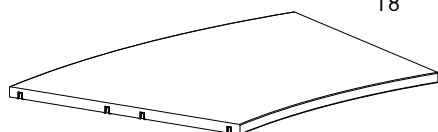

SHELVES

WO5 - ROUND WOODEN OVERLAYING TOP PLATE

Choose between a wooden top shelf (placed in between the wooden panels) or a wooden overlaying top plate (placed on top of the panels).

WO5 - ROUND WOODEN OVERLAYING TOP PLATE

Details:

- Melamine/painted/veneer
- Freestanding/outer/intermediate
- Max. weight 25 kg.
- Particle board

Use with:

- S5 - round steel shelves
- W5/W6/W7/W8 - round wooden shelves
- WP3/WP7 - wooden panel
- SBP5/7 - round steel back panel

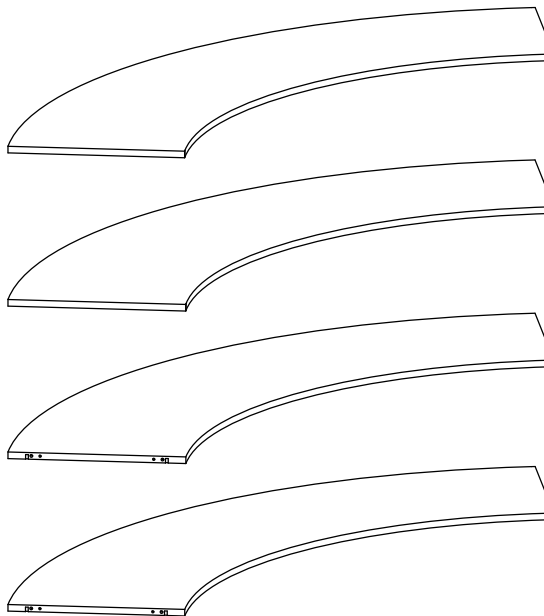

SHELVES

WO5 - ROUND WOODEN OVERLAYING TOP PLATE - DOUBLE-SIDED

Painted and veneered shelves are FSC-certified.

WO5 - round double-sided wooden overlaying top plate - freestanding

Particleboard. Incl. fittings.	Degree	Shelf depth mm	No. of bays	Item no.	Melamine EUR	Painted EUR	Veneer EUR
	26	300	1	BN2306615.	502,47	591,05	827,66
	26	300	2	BN2306625.	1.126,51	1.325,21	1.855,35
	26	300	3	BN2306635.	1.878,89	2.210,33	3.094,51
	18	300	1	BN2306815.	502,47	591,05	827,66
	18	300	2	BN2306825.	1.024,23	1.204,98	1.686,97
	18	300	3	BN2306835.	1.503,03	1.768,24	2.475,53

WO5 - round double-sided wooden overlaying top plate - left outer

Particleboard. Incl. fittings.	Degree	Shelf depth mm	No. of bays	Item no.	Melamine EUR	Painted EUR	Veneer EUR
	26	300	1	BN2306611.	500,88	589,19	824,87
	26	300	2	BN2306621.	1.125,31	1.324,02	1.853,49
	26	300	3	BN2306631.	1.877,83	2.209,26	3.093,05
	18	300	1	BN2306811.	500,88	589,19	824,87
	18	300	2	BN2306821.	1.023,17	1.203,65	1.685,11
	18	300	3	BN2306831.	1.502,37	1.767,44	2.474,47

WO5 - round double-sided wooden overlaying top plate - intermediate

Particleboard. Incl. fittings.	Degree	Shelf depth mm	No. of bays	Item no.	Melamine EUR	Painted EUR	Veneer EUR
	26	300	1	BN2306613.	496,36	583,87	817,42
	26	300	2	BN2306623.	1.104,57	1.299,41	1.819,17
	26	300	3	BN2306633.	1.862,40	2.190,91	3.067,25
	18	300	1	BN2306813.	496,36	1.181,31	1.653,86
	18	300	2	BN2306823.	1.004,02	1.752,67	2.453,85
	18	300	3	BN2306833.	1.489,73	589,19	824,87

WO5 - round double-sided wooden overlaying top plate - right outer

Particleboard. Incl. fittings.	Degree	Shelf depth mm	No. of bays	Item no.	Melamine EUR	Painted EUR	Veneer EUR
	26	300	1	BN2306612.	500,88	589,19	824,87
	26	300	2	BN2306622.	1.125,31	1.324,02	1.853,49
	26	300	3	BN2306632.	1.877,83	2.209,26	3.093,05
	18	300	1	BN2306812.	500,88	589,19	824,87
	18	300	2	BN2306822.	1.023,17	1.203,65	1.685,11
	18	300	3	BN2306832.	1.502,37	1.767,44	2.474,47

CASTORS

ROUND CASTOR FRAME & CASTOR PLATE



CASTORS

ROUND CASTOR FRAME & CASTORS

We recommend having a maximum of 3 adjoining bays mounted on castors.

Round castor frame set with visible castors

A set of 2 frames and 4 Ø75 mm castors. To be used with double-sided panels WP1, WP2, WP3, WP4 and back panels WPB1/WBP2. Max. height 1520 mm.

Degree	x castors with brake
26	0
26	2
18	0
18	2

Item no.	Price EUR
BN26060	372,27
BN26061	389,03
BN26080	372,27
BN26081	389,03

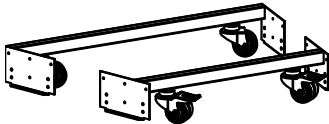

Castors for visible round castor frame set

Spare part. H112 mm, Ø75 mm. Max 90 kg. per castor.

Type

Item no.	Price EUR
----------	-----------

Without brake

B7860100	78,20
----------	-------

With brake

B7860101	94,70
----------	-------

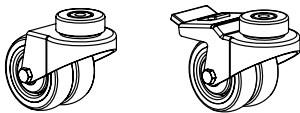

Round castor frame set with hidden castors and steel plinth

A set of 2 frames, 4 x Ø35 mm castors without brakes and 2 steel plinths. To be used with double-sided panels WP1, WP2, WP3, WP4 and back panels WPB1/WBP2. Max. height 1520 mm.

Degree

Item no.	Price EUR
----------	-----------

26

BN2616	569,51
--------	--------

18

BN2618	569,51
--------	--------

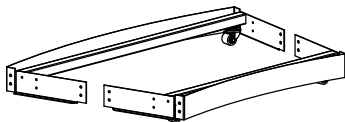

Castors for hidden round castor frame set

H50 mm, Ø35 mm. Spare part. Max. 100 kg per castor.

Type

Item no.	Price EUR
----------	-----------

Without brake

B301017	57,46
---------	-------

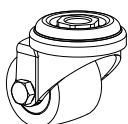

CASTORS

ROUND CASTOR PLATES

Painted and veneered castor plates are FSC-certified.

Double-sided round wooden castor plate

With 4/6/8 Ø75 mm castors, 2 of which are with brakes. To be used with double-sided panels WP5/WP7 for castor plate along with steel back panel SPB7/8 or steel back frame. Max. height 1520 mm.

Degree	Depth mm	No of bays	Item no.	Melamine EUR	Painted EUR	Veneer EUR
26	300	1	BN250661.	731,63	860,78	1.205,11
26	300	2	BN250662.	1.433,47	1.686,44	2.361,02
26	300	3	BN250663.	2.082,91	2.450,39	3.430,47
18	300	1	BN250681.	670,72	789,09	1.104,70
18	300	2	BN250682.	1.314,04	1.545,99	2.164,31
18	300	3	BN250683.	1.909,22	2.246,24	3.144,79

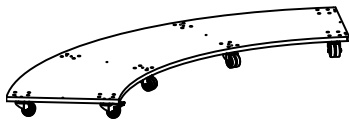

Castors for round castor plate

Spare part. H102 mm, Ø75 mm. Max 100 kg. per castor.

Type	Item no.	Price EUR
Without brake	B400001025	43,36
With brake	B400001125	52,80

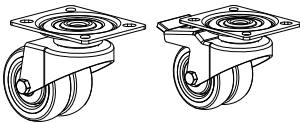

PLINTHS

ROUND STEEL PLINTHS

Painted and veneered plinths are FSC-certified.

Round steel plinth

Incl. screws. H71 mm. Cannot be used with castors.



26 Inner
26 Outer

Item no.

BN22761
BN22762

Price
EUR

34,05
34,05

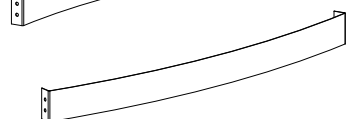

18 Inner
18 Outer

BN22781
BN22782

34,05
34,05

WOODEN PANELS

DOUBLE-SIDED - WITH ADJUSTABLE FEET - FOR WOODEN TOP SHELF

Painted and veneered panels are FSC-certified.

WP1 - double-sided outer end panel with adjustable feet - for WT5

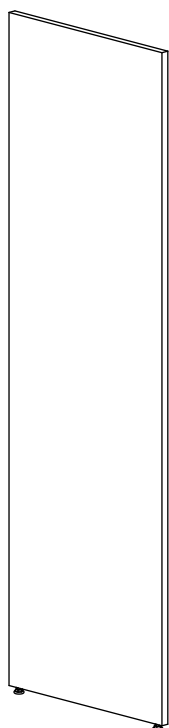

Height mm	Shelf depth mm	Item no.	Melamine EUR	Painted EUR	Veneer EUR
720	300	BN0014265.	158,80	186,73	273,58
920	300	BN0014365.	202,96	238,87	334,50
1220	300	BN0014465.	263,74	310,29	434,64
1520	300	BN0014565.	277,84	326,91	457,92
1820	300	BN0014665.	328,24	386,37	540,78
2120	300	BN0014765.	376,92	443,56	620,98

WP1 - double-sided intermediate panel with adjustable feet - for WT5

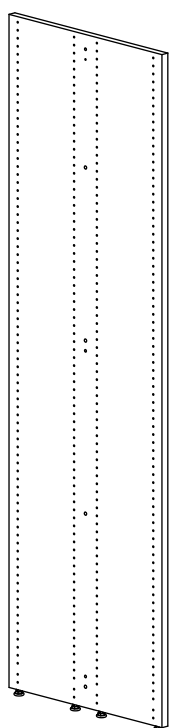

Height mm	Shelf depth mm	Item no.	Melamine EUR	Painted EUR	Veneer EUR
720	300	BN0014264.	158,80	186,73	261,61
920	300	BN0014364.	202,96	238,87	334,50
1220	300	BN0014464.	263,74	310,29	434,64
1520	300	BN0014564.	277,84	326,91	457,92
1820	300	BN0014664.	328,24	386,37	540,78
2120	300	BN0014764.	376,92	443,56	620,98

WOODEN PANELS

DOUBLE-SIDED - WITH ADJUSTABLE FEET - FOR STEEL AND WOODEN TOP SHELF

Painted and veneered panels are FSC-certified.

WP2 - double-sided slat outer end panel with milled slat - with adjustable feet - for ST1/ST2/ST3 and WT1

H1520 has 2 slats, H1820 and 2120 has 3 slats.

Height mm Shelf depth mm

Item no.

Melamine

Painted

Veneer

1520

300

BN0455651.

-

489,71

685,35

1820

300

BN0456651.

-

559,40

783,24

2120

300

BN0457651.

-

642,66

899,61

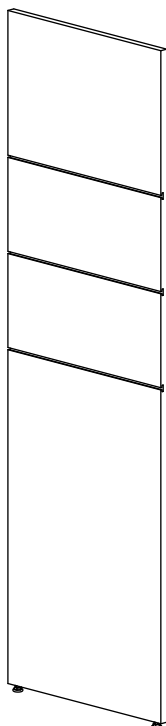

WOODEN PANELS

DOUBLE-SIDED - WITH ADJUSTABLE FEET & OVERLAYING TOP PLATE

Painted and veneered panels are FSC-certified.

WP3 - double-sided outer end panel with adjustable feet - for WO5

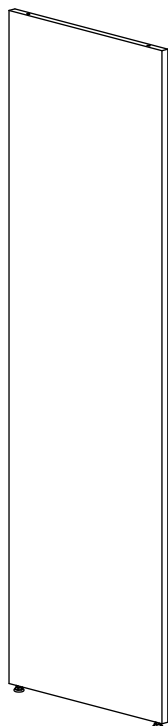

Height mm	Shelf depth mm	Item no.	Melamine EUR	Painted EUR	Veneer EUR
720	300	BN0014269.	158,80	186,73	261,61
920	300	BN0014369.	202,96	238,87	334,50
1220	300	BN0014469.	263,74	310,29	434,64
1520	300	BN0014569.	277,84	326,91	457,92
1820	300	BN0014669.	328,24	386,37	540,78
2120	300	BN0014769.	376,92	443,56	620,98

WP3 - double-sided intermediate panel with adjustable feet - for WO5

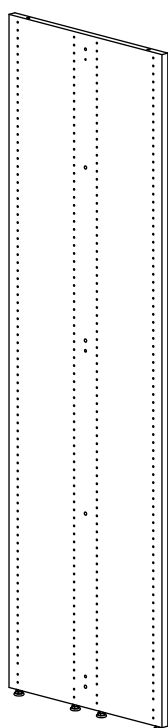

Height mm	Shelf depth mm	Item no.	Melamine EUR	Painted EUR	Veneer EUR
720	300	BN0014268.	158,80	186,73	261,61
920	300	BN0014368.	202,96	238,87	334,50
1220	300	BN0014468.	263,74	310,29	434,64
1520	300	BN0014568.	277,84	326,91	457,92
1820	300	BN0014668.	328,24	386,37	540,78
2120	300	BN0014768.	376,92	443,56	620,98

WOODEN PANELS

DOUBLE-SIDED - WITH ADJUSTABLE FEET & OVERLAYING TOP PLATE

Painted and veneered panels are FSC-certified.

WP4 - double-sided slat outer end panel with milled slat and adjustable feet - for WO1

H1520 has 2 slats, H1820 and 2120 has 3 slats.

Height
mm

Shelf depth
mm

Item no.

Melamine

Painted

Veneer

1520

300

BN0455691.

-

489,71

685,35

1820

300

BN0456691.

-

559,40

783,24

2120

300

BN0457691.

-

642,66

899,61

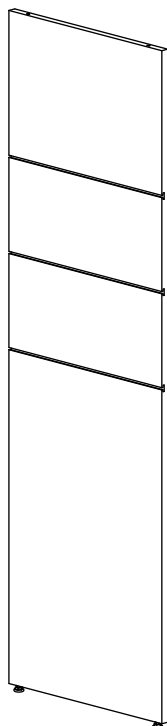

WOODEN PANELS

DOUBLE-SIDED - FOR CASTOR PLATE & WOODEN TOP SHELF

Painted and veneered panels are FSC-certified.

WP5 - double-sided outer end panel for castor plate - for WT5

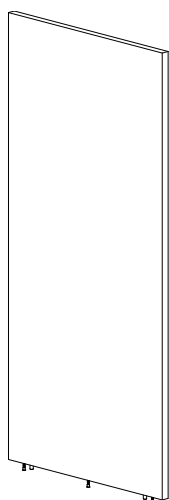

Height mm	Shelf depth mm	Item no.	Melamine EUR	Painted EUR	Veneer EUR
720	300	BN0015265.	158,80	186,73	261,61
920	300	BN0015365.	202,96	238,87	334,50
1220	300	BN0015465.	263,74	310,29	434,64
1520	300	BN0015565.	277,84	326,91	457,92

WP5 - double-sided intermediate panel for castor plate - for WT5

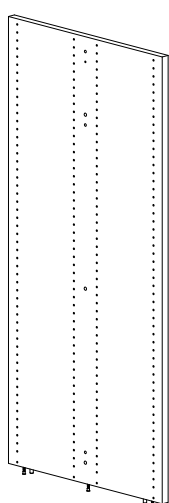

Height mm	Shelf depth mm	Item no.	Melamine EUR	Painted EUR	Veneer EUR
720	300	BN0015264.	158,80	186,73	261,61
920	300	BN0015364.	202,96	238,87	334,50
1220	300	BN0015464.	263,74	310,29	434,64
1520	300	BN0015564.	277,84	326,91	457,92

WOODEN PANELS

DOUBLE-SIDED - FOR CASTOR PLATE & TOP SHELF

Painted and veneered panels are FSC-certified.

WP6 - double-sided slat outer end panel with milled slats - for castor plate - for ST1/ST2/ST3 and WT1

H1520 has 2 slats.

Height
mm

Shelf depth
mm

Item no.

Melamine

Painted

Veneer

1520

300

BN0465651.

-

489,71

685,35

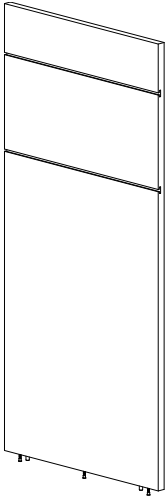

WOODEN PANELS

DOUBLE-SIDED - FOR CASTOR PLATE & OVERLAYING TOP PLATE

Painted and veneered panels are FSC-certified.

WP7 - double-sided outer end panel for castor plate - for WO5

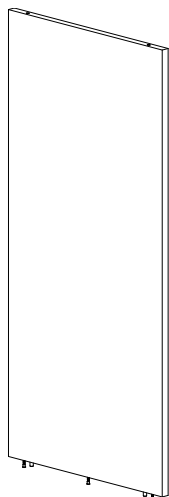

Height mm	Shelf depth mm	Item no.	Melamine EUR	Painted EUR	Veneer EUR
720	300	BN0015269.	158,80	186,73	261,61
920	300	BN0015369.	202,96	238,87	334,50
1220	300	BN0015469.	263,74	310,29	434,64
1520	300	BN0015569.	277,84	326,91	457,92

WP7 - double-sided intermediate panel for castor plate - for WO5

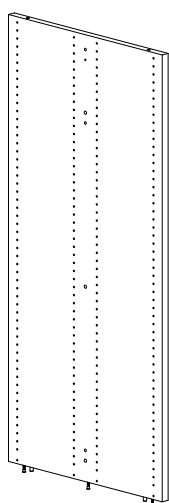

Height mm	Shelf depth mm	Item no.	Melamine EUR	Painted EUR	Veneer EUR
720	300	BN0015268.	158,80	186,73	261,61
920	300	BN0015368.	202,96	238,87	334,50
1220	300	BN0015468.	263,74	310,29	434,64
1520	300	BN0015568.	277,84	326,91	457,92

WOODEN PANELS

DOUBLE-SIDED - FOR CASTOR PLATE & OVERLAYING TOP PLATE

Painted and veneered panels are FSC-certified.

WP8 - double-sided slat outer end panel with milled slat - for castor plate - for WO1

H1520 has 2 slats.

Height
mm

Shelf depth
mm

Item no.

Melamine

Painted

1520

300

BN0465691.

-

489,71

685,35

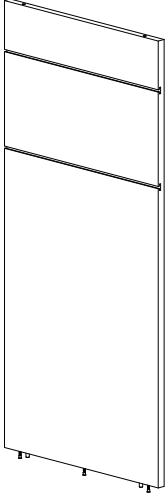

WOODEN PANELS

WOODEN END PANEL BAYS

Use the panel to create a display area on Lingo shelving system. The end panel bay is easily retrofitted on existing double-sided shelving systems with adjustable feet/castor frame (replace existing end panel with end panel bay). Painted and veneered panels are FSC-certified.

Wooden end panel bay - for bays with top shelf

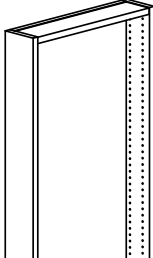
Fastening material included.	Height mm	Shelf depth mm	Width mm	Item no.	Melamine EUR	Painted EUR	Veneer EUR
	720	300	598	BN5402B1.	685,48	846,68	1.185,43
	920	300	598	BN5403B1.	863,57	1.015,99	1.422,57
	1220	300	598	BN5404B1.	1.036,34	1.219,34	1.706,92
	1520	300	598	BN5405B1.	1.191,95	1.402,22	1.963,08
	1820	300	598	BN5406B1.	1.370,57	1.612,49	2.257,41
	2120	300	598	BN5407B1.	1.439,19	1.693,22	2.370,46

Wooden end panel bay - for bays with overlaying top plate

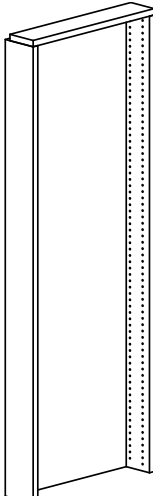
Fastening material included.	Height mm	Shelf depth mm	Width mm	Item no.	Melamine EUR	Painted EUR	Veneer EUR
	720	300	598	BN5402B2.	719,66	846,68	1.185,43
	920	300	598	BN5403B2.	863,57	1.015,99	1.422,57
	1220	300	598	BN5404B2.	1.036,34	1.219,34	1.706,92
	1520	300	598	BN5405B2.	1.191,95	1.402,22	1.963,08
	1820	300	598	BN5406B2.	1.370,57	1.612,49	2.257,41
	2120	300	598	BN5407B2.	1.439,19	1.693,22	2.370,46

WOODEN PANELS

WOODEN END PANEL BAYS

The functions below are suited for hanging on wooden end panel bays. Painted and veneered products are FSC-certified.

Wooden sign for wooden end panel bay

H368 mm. Incl. fittings.	Width mm	Shelf depth mm	Item no.	Melamine EUR	Painted EUR	Veneer EUR
	598	300	BN541B.	171,84	202,03	283,02

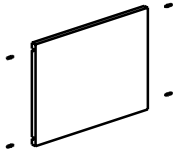

Steel display shelf for wooden end panel bay

H280 mm. Incl. fittings.	Width mm	Shelf depth mm	Item no.	Steel EUR
	598	300	BN542B	130,87

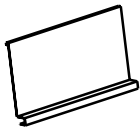

Wooden brochure rack for wooden end panel bay

H140 mm. Front and three adjustable dividers in acrylic glass. Incl. fittings.	Width mm	Shelf depth mm	Item no.	Melamine EUR	Painted EUR	Veneer EUR
	598	300	BN543B.	346,73	407,91	570,97

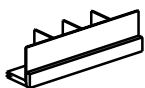

CONNECTION ELEMENTS

ROUND STEEL BACK PANELS - FOR ADJUSTABLE FEET

SBP5 - high steel back panel - for WT5/WT7 (standard depth)/WO5

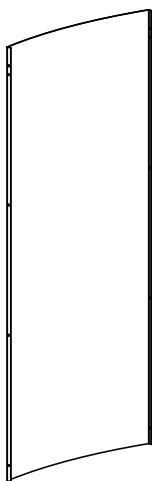

Degree	Height mm	Item no.	Price EUR
26	720	BN219264	204,55
26	920	BN219364	261,35
26	1220	BN219464	346,60
26	1520	BN219564	431,72
26	1820	BN219664	516,97
26	2120	BN219764	602,09
18	720	BN219284	204,55
18	920	BN219384	261,35
18	1220	BN219484	346,60
18	1520	BN219584	431,72
18	1820	BN219684	516,97
18	2120	BN219784	602,09

SBP6 - low steel back panel - for WT5/WT7 (double-sided)

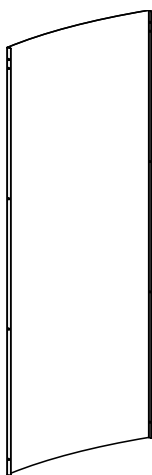

Degree	Height mm	Item no.	Price EUR
26	720	BN219266	204,55
26	920	BN219366	261,35
26	1220	BN219466	346,60
26	1520	BN219566	431,72
26	1820	BN219666	516,97
26	2120	BN219766	602,09
18	720	BN219286	204,55
18	920	BN219386	261,35
18	1220	BN219486	346,60
18	1520	BN219586	431,72
18	1820	BN219686	516,97
18	2120	BN219786	602,09

CONNECTION ELEMENTS

ROUND STEEL BACK PANELS - FOR CASTOR PLATE

SBP7 - high steel back panel - for WT5/WT7 (standard depth)/WO5

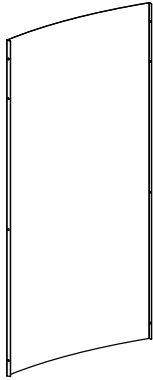

Degree	Height mm	Item no.	Price EUR
26	720	BN220264	204,55
26	920	BN220364	261,35
26	1220	BN220464	346,60
26	1520	BN220564	431,72
18	720	BN220284	204,55
18	920	BN220384	261,35
18	1220	BN220484	346,60
18	1520	BN220584	431,72

SBP8 - low steel back panel - for WT5/WT7 (double-sided)

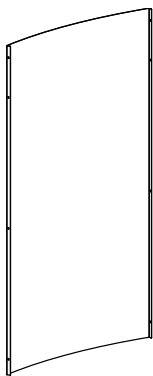

Degree	Height mm	Item no.	Price EUR
26	720	BN220266	204,55
26	920	BN220366	261,35
26	1220	BN220466	346,60
26	1520	BN220566	431,72
18	720	BN220286	204,55
18	920	BN220386	261,35
18	1220	BN220486	346,60
18	1520	BN220586	431,72

CONNECTION ELEMENTS

ROUND STEEL BACK FRAME

To ensure correct stability, double-sided shelvings H1820 mm and H2120 mm with back frame must have an additional steel back frames installed depending on number of bays. Configurations for freestanding bays include one additional back frame. Back frame for intermediate bays must be ordered separately, see overview page 11.

Round steel back frame

With fittings.

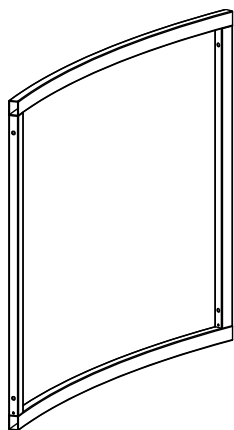

Degree	Bay	Item no.	Price EUR
26	Freestanding	BN21064ZZZ8	272,65
26	Intermediate	BN21064ZZZ9	272,65
18	Freestanding	BN21084ZZZ8	272,65
18	Intermediate	BN21084ZZZ9	272,65



LOCATIONS

WE ARE LIBRARY PEOPLE®



DENMARK

Lammhults Biblioteksdesign A/S
Dalbækvej 1
6670 Holsted

bci@bci.dk
www.bci.dk

SWEDEN

Lammhults Biblioteksdesign AB
Odlarevägen 16
226 60 Lund

eurobib@eurobib.se
www.eurobib.se

UNITED KINGDOM

thedesignconcept Ltd.
The Old Bakery,
10 Greenless Road
Cambuslang Belgrave Street
Glasgow G72 8JJ

info@thedesignconcept.co.uk
www.thedesignconcept.co.uk

FRANCE

BC Intérieur Sarl
6 allée Kepler
77420 Champs sur Marne

bci@bcinterieur.com
www.bcinterieur.com

GERMANY

Schulz Speyer Bibliothekstechnik AG
Hafenstraße 2
67346 Speyer

sales@schulzspeyer.de
www.schulzspeyer.de

NORWAY

BS Eurobib AS
Alf Bjerckes Vei 20
0582 Oslo

post@bseurobib.no
www.bseurobib.no

BELGIUM

SBNL - Schulz Benelux BVBA
Appelweg 94 C
3221 Holsbeek

info@sbnl.be
www.sbnl.be