



60/30 CLASSIC

EUR PRICE LIST

01.01.2024



60/30 CLASSIC STEEL SHELVING

The 60/30 Classic Steel Shelving system is the essence of many years of experience and success. This flexible product concept has evolved over the years and the modular structure and the large number of standard components ensure ideal room utilization and rational accommodation of all relevant functions. In addition the flexibility of the system allows a variety of individual solutions which our design teams bring to life for the individual library.

You will find all our standard products in this overview. For additional inspiration we invite you to visit our website, where you can find project inspiration from our latest projects around the world.

The 60/30 Classic Steel Shelving system is shown in many creative configurations mixed with special developments such as round shelving with seating benches and castors, integrated youth corners with tables and chairs etc. Our broad portfolio of library furniture provides endless possibilities. Please contact our professional sales teams for inspiration.



The price list is valid from 01.01.2024 until 31.12.2024.

Conditions of sale and terms of delivery

All prices excluding VAT and delivery. Please see our conditions of sale and terms of delivery on our website.

Updating the price list

The price list will continually be updated and can be downloaded on our website. Please contact our sales office, who will forward a log-in and password via e-mail. We reserve the right to make product and price alterations without prior notice and accept no liability for printing errors.

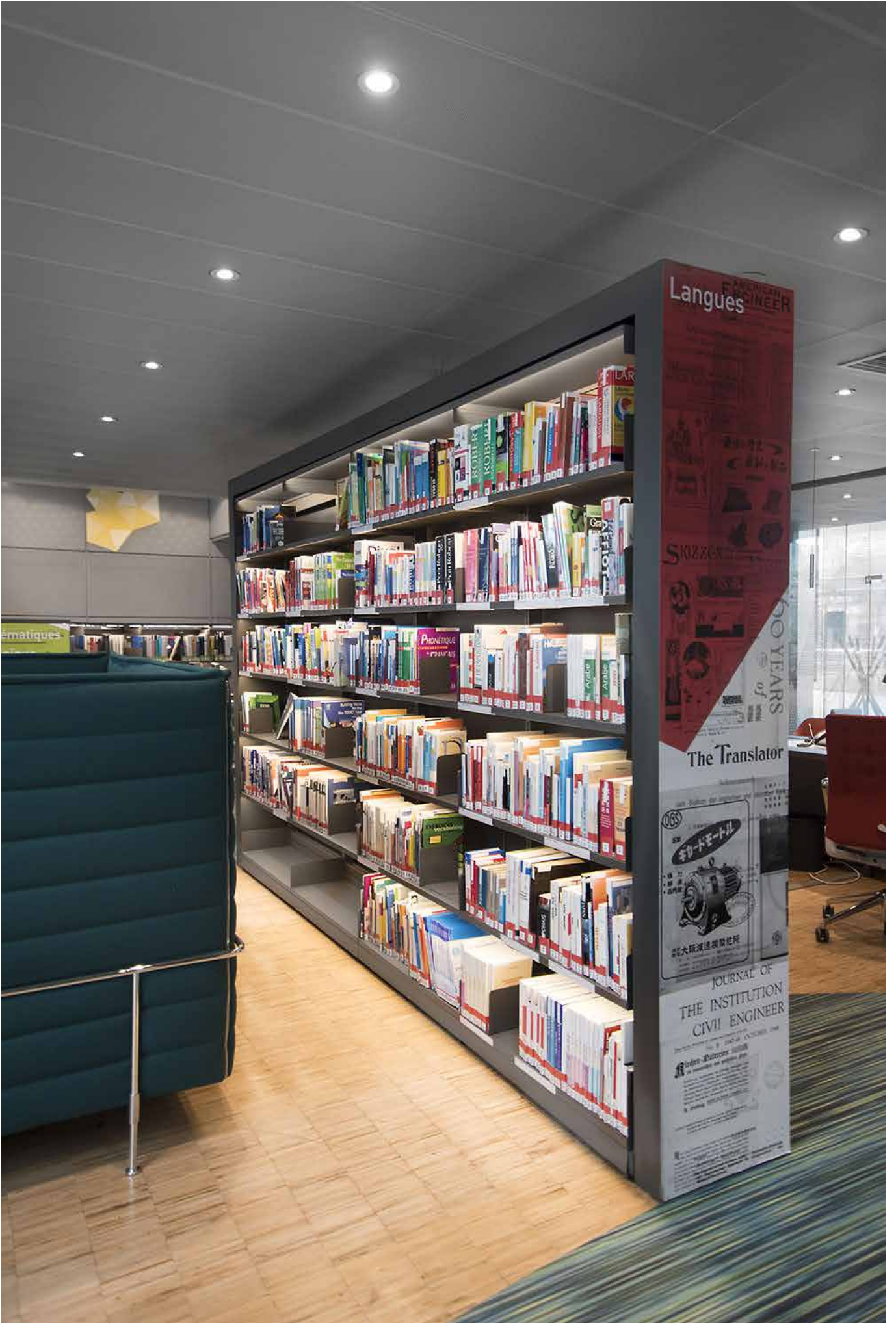

INDEX

FSC	6
DESIGN OPTIONS	9
TECHNICAL SPECIFICATIONS	12
DIMENSIONS	16

STRAIGHT CONFIGURATIONS

60/30 CLASSIC STEEL SHELVING	26
Single-sided configurations without shelves	28
Double-sided configurations without shelves	30
Single-sided configurations without top shelf	32
Double-sided configurations without top shelf	34
Single-sided configurations with top shelf	36
Double-sided configurations with top shelf	38
60/30 CLASSIC STEEL SHELVING WITH LED	40
Single-sided configurations without top shelf	42
Double-sided configurations without top shelf	44
Single-sided configurations with top shelf	46
Double-sided configurations with top shelf	48
80/30 CLASSIC STEEL SHELVING	50
Single-sided configurations	52
Double-sided configurations	53
60/30 CLASSIC STEEL SHELVING - WALL	54
Single-sided configurations	56
60/30 EXPO	58
Double-sided configurations - H122 cm	60
Double-sided configurations - H152 cm	63

COMPONENTS FOR STRAIGHT SHELVING

SHELVES	
Steel shelves	66
Steel top shelves and London top plates	74
Wooden shelves	102
Wooden top shelves and London top plates	104
Accessories for shelves	113
ACCESSORIES	
Book supports	114
Browsers	116
Display & storage - magazines	121
Display & storage - multimedia	125
Display & storage - for shelves	126
Display & storage - for slat end panels	128
Display & storage - for perforated end panels	129
Signage - for end panels/uprights/tops	131
Signage - for shelves	132
UPRIGHTS & CROSSBARS	
Uprights for 60/30 Classic	134
Uprights for 80/30 Classic	135
Wall strips for 60/30 Classic	136
Uprights, frame and castor set for hidden castors	137
Upright extensions & crossbars	138
CASTORS & PLINTHS	
Plinths & castors	139
PANELS	
Wooden end panels	140
Wooden slat end panels	142
Wooden London end panel	144
Perforated steel end panels	146
Steel London end panels	147
Glass end panels	148
Back panels	149
END PANEL BAYS	
End panel bay with adjustable feet	152
End panel bay with adjustable feet and London top	154
End panel bay with castors	156
End panel bay with castors and London top	157
Steel shelves for end panel bays	158
LIGHTING	
LED lighting	160
Book LED lighting	162

EUR

ROUND CONFIGURATIONS

60/30 ROUND STEEL SHELVING	164
Double-sided configurations without shelves	165
Double-sided configurations without top shelf	166
Double-sided configurations with top shelf	167

COMPONENTS FOR ROUND SHELVING

SHELVES	
Steel shelves	168
Steel top shelves	170
Wooden London top plates	176
Components for shelves	177
UPRIGHTS & CROSSBARS	
Uprights for 60/30 Classic Round	178
Crossbars	178
CASTORS & PLINTHS	
Plinths & castors	179
PANELS	
Wooden end panels	181
Wooden slat end panels	182
Wooden London end panels	183
Perforated steel end panels	184
END PANEL BAYS	
End panel bay with adjustable feet	188
End panel bay with adjustable feet and London top	190
End panel bay with castors	192
End panel bay with castors and London top	193
Steel shelves for end panel bays	194



WOOD FROM SUSTAINABLE MANAGED FORESTRY

We are committed to increasing the share of sustainable raw wooden material in our products and thereby support responsibly managed forests – for a better world.

Governments and local authorities are specifying the supply of legal and responsibly sourced wood in their procurement policies.

We have invested in a Chain-of-Custody Multi-site certificate (FSC-C 144988), issued by FSC®, which documents, that we can offer wood from responsibly managed forests. FSC (Forest Stewardship Council) is an international labeling scheme, that documents that FSC labelled products originate from sustainable forestry.

Working with certified suppliers, we can now offer all painted and veneered components as fully FSC Mix certified (noted in this document for each wooden product, which is FSC-certified).



What is sustainable managed forestry?

According to the FSC, forests, managed according to their principles and criteria, mean fair conditions for workers, respect for indigenous communities and local populations as well as strict environmental controls.

The FSC label guarantees that the trees that are harvested are replaced or allowed to regenerate naturally.

The FSC label also guarantees that all the wood is tracked from the forest to the store. Every link between the forest and the consumer is certified to make it clearly identifiable which wood is from sustainable forestry and which is not.

Source: Forest Stewardship Council
<http://www.fsc-uk.org/en-uk>





DESIGN OPTIONS

STEEL COMPONENTS - PAINTED

A PRICE GROUP - BASIS PRICE (smooth finish)



A03
Traffic white
RAL 9016
Gloss 75-90



A02
Oyster white
RAL 1013
Gloss 40-50



A22
Moss green
RAL 6005
Gloss 71-85

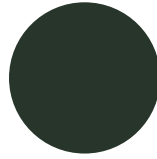

A26
Fir green
RAL 6009
Gloss 71-85

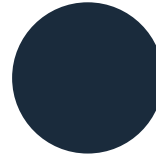

A12
Steel blue
RAL 5011
Gloss 71-85

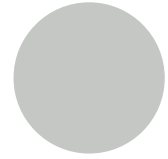

A13
Light grey
RAL 7035
Gloss 71-85

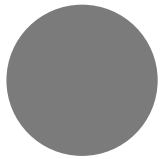

A15
Dusty grey
RAL 7037
Gloss 71-85

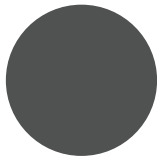

A16
Traffic grey
RAL 7043
Gloss 71-85

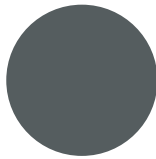

A17
Basalt grey
RAL 7012
Gloss 71-85

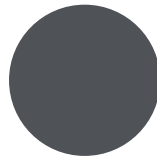

A18
Slate grey
RAL 7015
Gloss 71-85

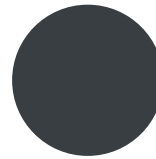

A19
Anthracite grey
RAL 7016
Gloss 71-85

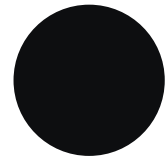

A25
Jet black
RAL 9005
Gloss 71-85

B PRICE GROUP - BASIS PRICE WITH 7% SURCHARGE (smooth finish)



A01
Pure white
RAL 9010
Gloss 71-85



A04
Traffic yellow
RAL 1023
Gloss 71-85

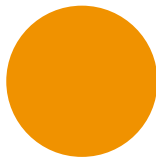

A05
Sun yellow
RAL 1037
Gloss 71-85

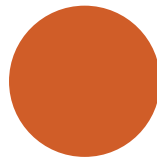

A06
Signal orange
RAL 2010
Gloss 71-85

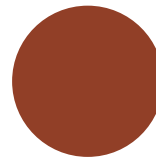

A07
Pearl orange
RAL 2013
Gloss 65-85

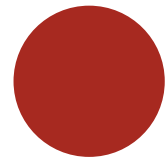

A08
Flame red
RAL 3000
Gloss 71-85

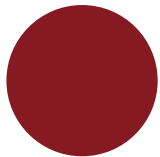

A09
Ruby red
RAL 3003
Gloss 71-85



A21
Reseda green
RAL 6011
Gloss 71-85

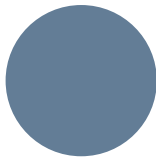

A10
Pigeon blue
RAL 5014
Gloss 71-85

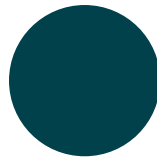

A11
Ocean blue
RAL 5020
Gloss 71-85

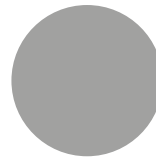

A14
White aluminium
RAL 9006
Gloss 50-70

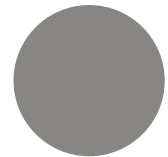

A31
Grey aluminium
RAL 9007
Gloss 50-70

B PRICE GROUP - BASIS PRICE WITH 7% SURCHARGE (textured finish)



A27
Pure white
RAL 9010

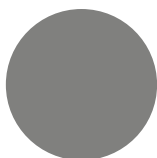

A29
Concertina grey

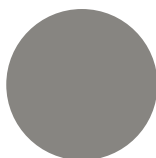

A28
Grey aluminium
RAL 9007

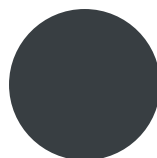

A23
Anthracite grey
RAL 7016

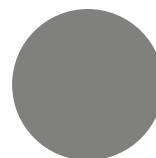

A24
Graphite black
RAL 9011

Note:

- Other RAL/NCS colours have a starter fee of GBP 215 / EUR 250 and a surcharge of 15%. A higher surcharge for colours with "metallic" look or different surface textures must be expected.
- See specific colour for steel gloss specification. Special requests outside specified gloss range are not covered by the above surcharges.
- Chrome, electro galvanised and aluminium parts are not available in other colours.
- Products such as e.g. castors and accurides cannot be produced in other colours than described in the price list.

DESIGN OPTIONS

WOODEN COMPONENTS - PAINTED

A PRICE GROUP - BASIS PRICE

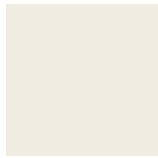

A01
Pure white
RAL 9010
Gloss 20-30



A02
Oyster white
RAL 1013
Gloss 20-30

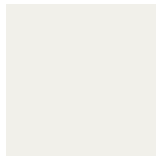

A03
Traffic white
RAL 9016
Gloss 20-30



A04
Traffic yellow
RAL 1023
Gloss 20-30



A05
Sun yellow
RAL 1037
Gloss 20-30



A06
Signal orange
RAL 2010
Gloss 20-30



A07
Pearl orange
RAL 2013
Gloss 20-30



A08
Flame red
RAL 3000
Gloss 20-30



A09
Ruby red
RAL 3003
Gloss 20-30



A21
Reseda green
RAL 6011
Gloss 20-30



A22
Moss green
RAL 6005
Gloss 20-30



A26
Fir green
RAL 6009
Gloss 20-30



A10
Pigeon blue
RAL 5014
Gloss 20-30



A11
Ocean blue
RAL 5020
Gloss 20-30



A12
Steel blue
RAL 5011
Gloss 20-30



A13
Light grey
RAL 7035
Gloss 20-30



A14
White aluminium
RAL 9006
Gloss 20-30



A31
Grey aluminium
RAL 9007
Gloss 20-30



A15
Dusty grey
RAL 7037
Gloss 20-30



A16
Traffic grey
RAL 7043
Gloss 20-30



A17
Basalt grey
RAL 7012
Gloss 20-30



A18
Slate grey
RAL 7015
Gloss 20-30



A19
Anthracite grey
RAL 7016
Gloss 20-30



A25
Jet black
RAL 9005
Gloss 20-30

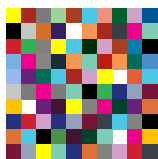

Any RAL/NCS colour
Gloss 20-30

Note:

- The above selection of colours match our steel colours. Note that you can order any RAL/NCS colour without surcharge.
- A surcharge for colours with "metallic" look or different surface textures must be expected, please contact Customer Service.

DESIGN OPTIONS

WOODEN COMPONENTS - VENEER

A PRICE GROUP - BASIS PRICE



55
Light steamed
beech



66
Oak



67
Maple



68
Ash



69
Birch

Note:

- The wooden veneers can also be stained for a surcharge, please contact Customer Service. Samples will be forwarded for approval.

TECHNICAL SPECIFICATIONS

GENERAL SPECIFICATIONS

DIMENSIONS

Dimensions of complete bays in available modules and heights can be found in each catalogue section which include complete configurations. See index page for overview.

MOUNTING TOLERANCES

The tolerances of the increments of the column limit the number of shelving bays, which can be built together. Generally the tolerances permit up to 10 successive bays. Above 10 bays it is advised to continue with a starter bay.

MAXIMUM LOAD

Steel top shelf - max. load of 25 kg.

Steel shelf with backedge - max. load of 80 kg.

Round steel top shelf - max. load of 25 kg.

Round steel shelf with backedge - max. load of 30 kg.

Round steel shelf with backedge and shelf strengthener - max. load of 80 kg.

Wooden top shelf - particleboard - max. load of 25 kg.

Wooden shelf with backedge - block board - max. load of 80 kg.

Steel browser with pull-out frame - max. load of 40 kg

MOBILE SHELVINGS/CASTORS

Only double-sided shelving units with a max. height of 152 cm and maximum 3 bays can be mounted with castors. Castors are available with or without brakes. Max. load of 120 kg per castor, max. load of 100 kg per hidden castor.

EXTENSIONS FOR UPRIGHTS

are used to increase the capacity. Enables an extra layer of shelves. Available for single- and double-sided uprights. Can be used for uprights of max. height of 229 cm.

STABILITY

All uprights are provided with adjustable feet that can be adjusted even when the system is loaded. Single-sided uprights are supplied with anti-topple brackets.

ROUNDED EDGES

All storage units and brackets have rounded edges.

BROWSERS

It is important to remember the following, when installing browsers in a shelving system:

- Browsers without tubes are meant for low medias with a maximum height of 20 cm, meaning they are not suited for e.g. picture books, as they may tip over the edge. If you wish to use store/display tall medias in browsers, then it is recommended to use single browsers with tubes, 20 cm in height and to place the books as far back as possible.
- The foot of the upright must minimally be the same depth as the browser, meaning that a 30 cm deep browser must only be installed on a 30 or 40 cm deep upright and a 40 cm deep browser on a 40 cm deep upright.
- We recommend that all shelving systems with browsers are either fixed to the floor or wall.
- Ensure that children do not play/crawl/hang on the shelving system.
- The maximum weight for each pull-out browser is 45 kg.

ASSEMBLY

No special fittings or tools are needed.

TECHNICAL SPECIFICATIONS

STEEL COMPONENTS

STEEL COMPONENTS

are powder coated with standard polyester based powders that secures high UV resistance. Powders comply with EN 45545 (fire protection - similar to DIN 4201). Thickness of the coating is 60-80 my. The powder used includes no triglycidylisocyanurate (TGIC), no heavy metal-containing pigments such as lead and cadmium and no volatiles

Steel components are not treated with any biocidal products.

Antibacterial equipping of surfaces upon request.

STEEL UPRIGHTS

are made of steel square tubes. The freestanding single- and double-faced uprights are available in two strengths which are recommended based on load carrying requirements. Choose between configurations with either 60 x 30 mm or 80 x 30 mm external dimensions. The upright is 2 mm thick and the welded foot is 3 mm thick. The uprights allow a wide range of shelves and other functions to be mounted in a row of punched holes with a distance of 25 mm. The uprights are provided with plastic caps to close the tube ends. The uprights are also provided with adjustable feet, adjustable to a max. of 25 mm.

STEEL WALL STRIPS

are made of 2 mm steel coils. The uprights allow a wide range of shelves and other functions to be mounted in a row of punched holes with a distance of 25 mm.

STEEL CROSSBARS

are made of 1.4 mm sheet steel. The crossbars are with hooks for easy connection to uprights. The uprights are connected with 2 crossbars for each bay. The top and bottom crossbar have an opening/groove to allow back panels to be fitted to the uprights without the use of special fittings or tools. A third crossbar is used on first and every third 229 and 259 cm high shelving bay. For heavy load it is recommended to use 3 crossbars in each bay. The third crossbar will be mounted at a fixed position using the slots at height 98 cm above the floor.

STEEL CROSSBARS FOR ROUND SHELVING

are made of 20 x 70 x 2 mm steel square tubes. The crossbars are with connection fittings for easy connection to uprights. The uprights are connected with 2 crossbars for each bay.

STEEL BRACKETS

are made of 1.4 mm sheet steel.

STEEL SHELVES/BROWSERS/CABINETS/PULL-OUT SHELVES

are made of 0.9 mm sheet steel. The flat steel shelves have a 25 mm high front edge. The sloping steel shelves are bent in a way so they have a stopper to prevent magazines from sliding off. Flat steel shelves can be mounted in a sloping position by changing brackets.

STEEL PLINTHS

are 60 mm high and made of 0.9 mm sheet steel.

LONDON STEEL PLINTHS

are made of 0.9 mm sheet steel over 1 and 2 bays and 1.5 mm sheet steel over 3 bays.

PERFORATED STEEL END PANELS

are made of 1.4 mm sheet steel. The perforations are Ø4.5 mm.

LONDON STEEL END PANELS AND TOPS

are made of 1.4 mm sheet steel with a 30 mm wide front edge.

TECHNICAL SPECIFICATIONS

WOODEN COMPONENTS

DENSITY

Particle board has a density of 600-700 kg/m³

Block board has a density of 602 m³ (+/- 2 %)

MDF has a density of 700 kg/m³ (+/- 5-7 %)

PAINTED WOODEN COMPONENTS

are made of MDF (medium density fibre board) which is painted with acid lacquer. Standard components have gloss 20 - 30, except for shelves for Expo that have gloss 60 - 70.

PAINTED PANELS

are made of 19 mm MDF. The wooden panels are supplied with fittings and hooks for easy connection to uprights.

PAINTED DISPLAY PANELS

are made of 22 mm MDF. The wooden panels are supplied with fittings with hooks for easy connection to uprights.

PAINTED LONDON WOODEN PANELS AND TOPS

are made of 30 mm MDF. Along the vertical edges of the panel a flat aluminium profile is attached. The aluminium profile is powder coated in the specified colour. The profiles are mounted on the front edge of panels using visible euro screws which are powder coated in the specified colour. The end panels and top are attached to the shelving using steel brackets.

PAINTED BACK PANELS

are made of 12 mm MDF.

PAINTED TOP SHELVES

are made of 22 mm MDF.

PAINTED SHELVES EXPO

are made of 22 mm MDF with special PU paint to increase robustness.

VENEERED WOODEN COMPONENTS

are mainly lacquered with UV-lacquer.

VENEERED PANELS

are made of 19 mm particleboard and are veneered with 0.6 mm veneer. All vertical and horizontal edges have a 2 mm veneer edge. The wooden panels are supplied with fittings and hooks for easy connection to uprights.

VENEERED DISPLAY PANELS

are made of 22 mm MDF and are veneered with 0.6 mm veneer. All vertical and horizontal edges have a 2 mm veneer edge. The wooden panels are supplied with fittings with hooks for easy connection to uprights.

VENEERED BACK PANELS

are made of 12 mm particleboard and are veneered with 0.6 mm veneer.

VENEERED SHELVES

are made of 22 mm block board and are veneered with 0.6 mm veneer. The front and back edges have a 2 mm veneer edge.

VENEERED TOP SHELVES

are made of 22 mm particleboard and are veneered with 0.6 mm veneer. The front and back edges have a 2 mm veneer edge.

VENEERED CORNER SHELVES

are made of 22 mm particleboard and are veneered with 0.6 mm veneer. The straight edges have a 2 mm veneer edge and the front has a 1 mm wooden edge strip.

TECHNICAL SPECIFICATIONS

GLASS COMPONENTS

GLASS COMPONENTS

GLASS END PANELS

are made of hardened frosted glass. Satimat 10 mm with straight mat facet edges.

DIMENSIONS

60/30 CLASSIC

Please find important dimensions below, configurations can be found on page 26.

HEIGHTS

The shelving system is available in 5 heights; 92, 122, 152, 182 and 212 cm. Heights include adjustable feet (max. 2.5 cm). The shelves are adjustable in 2.5 cm increments.

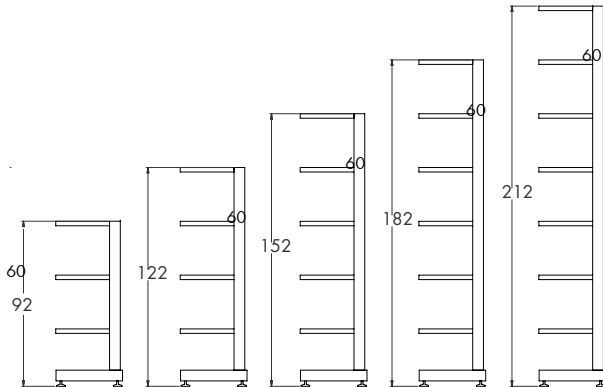

WIDTHS

The bays are available as starter and add-on bays. A starter bay has two uprights and an add-on bay has one upright.

78 cm is shown as module 75 in price list
 93 cm is shown as module 90 in price list
 103.5 is shown as module 100 in price list*

Module 75, 90 and 100 indicate distance from centre to centre of uprights.

*The exact measure of module 100 is 100.5 cm

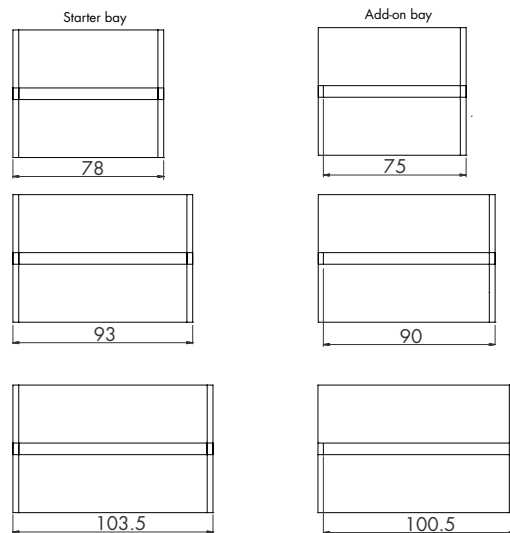

DEPTHS

The uprights are available in 4 depths:

- 30 cm for 22.5 cm deep shelves
- 32 cm for 25 cm deep shelves
- 37 cm for 30 cm deep shelves
- 47 cm for 40 cm deep shelves

- 51 cm for 2 x 22.5 cm deep shelves
- 56 cm for 2 x 25 cm deep shelves
- 66 cm for 2 x 30 cm deep shelves
- 86 cm for 2 x 40 cm deep shelves

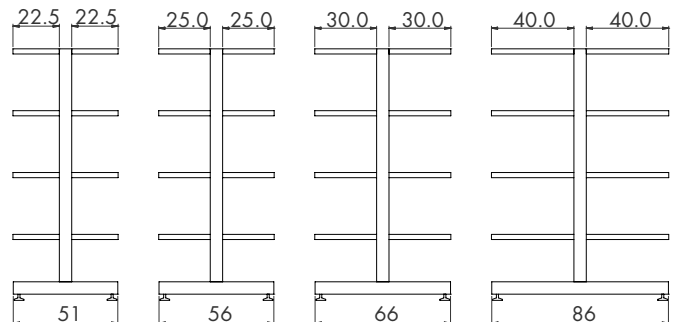
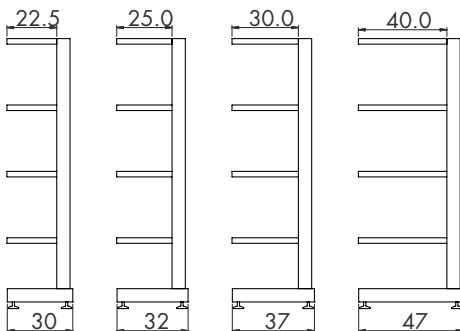

DIMENSIONS

80/30 CLASSIC

Please find important dimensions below, configurations can be found on page 50.

HEIGHTS

80/30 Classic Steel shelving system comes in 3 heights; 199, 229 and 259 cm. Heights include adjustable feet (max. 2.5 cm). The shelves are adjustable in 2.5 cm increments.

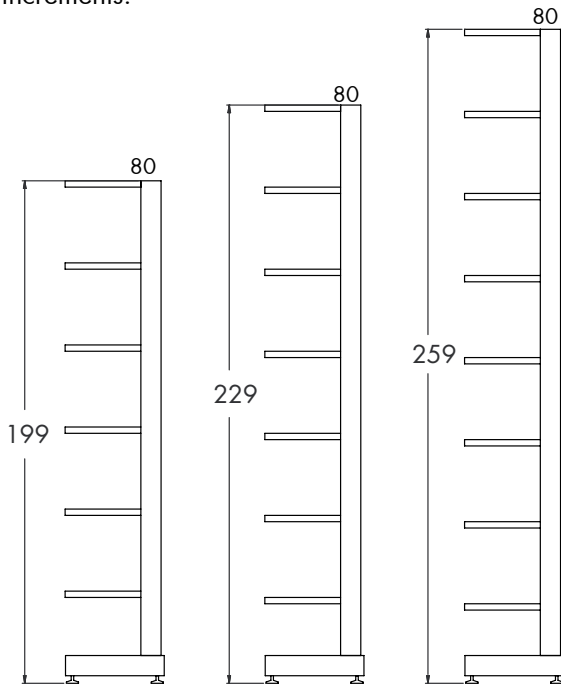

WIDTHS

The bays are available as starter and add-on bays. A starter bay has two uprights and an add-on bay has one upright.

78 cm is shown as module 75 in price list
93 cm is shown as module 90 in price list
103.5 is shown as module 100 in price list*

Module 75, 90 and 100 indicate distance from centre to centre of uprights.

*The exact measure of module 100 is 100.5 cm

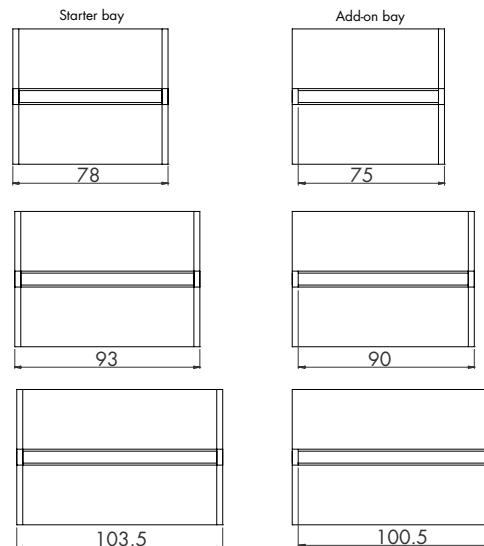

DEPTHS

The uprights come in 4 depths:
32 cm for 22.5 cm deep shelves
34 cm for 25 cm deep shelves
39 cm for 30 cm deep shelves
49 cm for 40 cm deep shelves

53 cm for 2x22.5 cm deep shelves
58 cm for 2x25 cm deep shelves
68 cm for 2x30 cm deep shelves
88 cm for 2x40 cm deep shelves

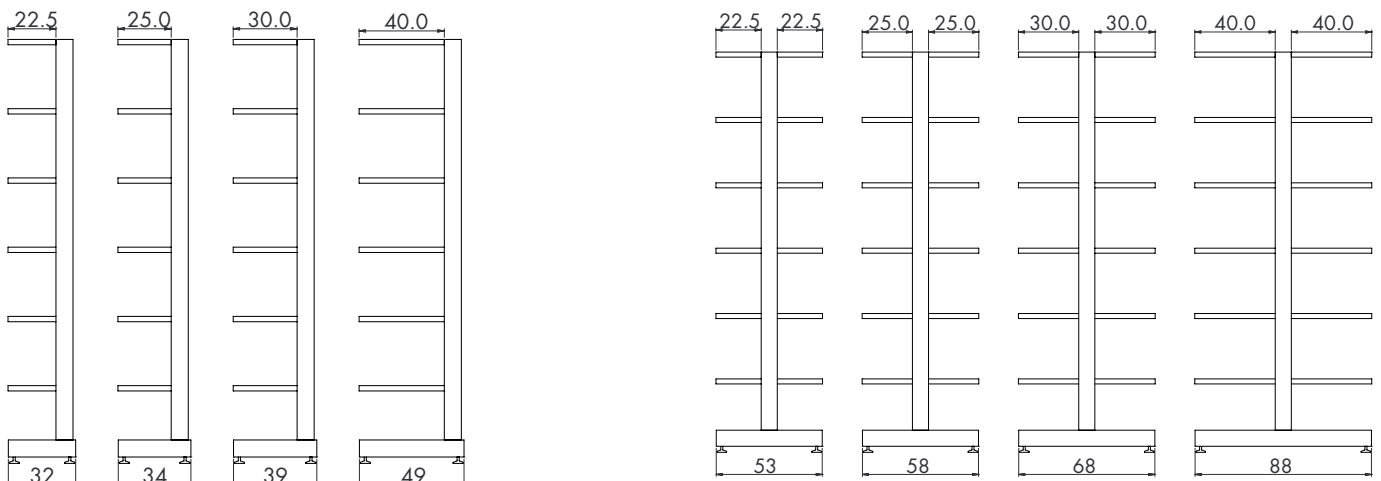

DIMENSIONS

60/30 CLASSIC WALL

Please find important dimensions below, configurations can be found on page 54.

HEIGHTS

60/30 Classic Steel shelving - Wall system comes in 4 heights; 112.5, 142.5, 172.5 and 202.5 cm. The shelves are adjustable in 2.5 cm increments.

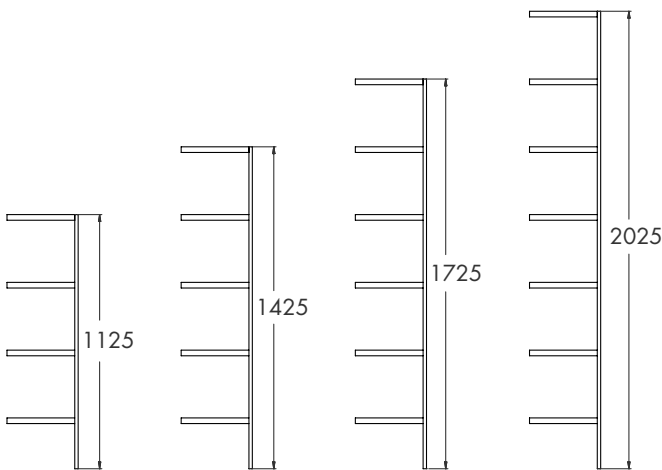

WIDTHS

The bays are available as starter and add-on bays. A starter bay has two wall strips and an add-on bay has one wall strip.

78 cm is shown as module 75 in price list
 93 cm is shown as module 90 in price list
 103.5 is shown as module 100 in price list*

Module 75, 90 and 100 indicate distance from centre to centre of uprights.

*The exact measure of module 100 is 100.5 cm

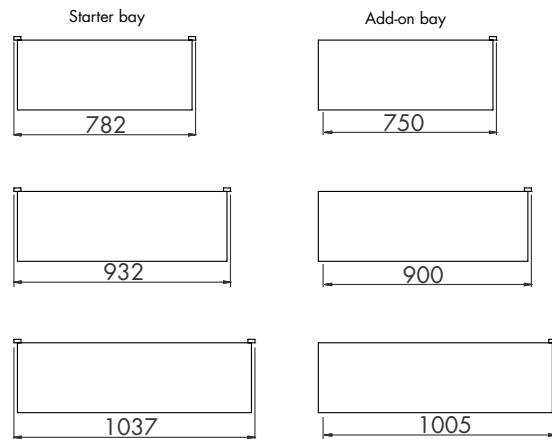

DEPTHS

The uprights come in 4 depths:
 24 cm for 22.5 cm deep shelves
 26.5 cm for 25 cm deep shelves
 31.5 cm for 30 cm deep shelves
 41.5 cm for 40 cm deep shelves

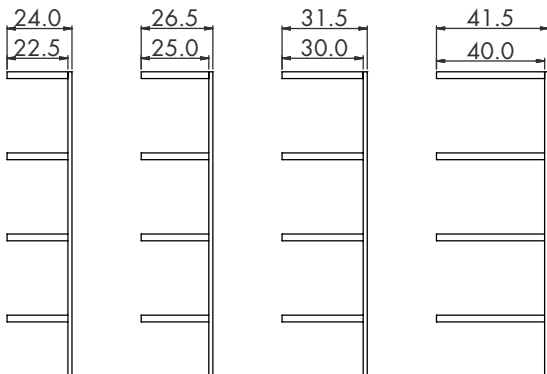

DIMENSIONS

60/30 EXPO

Please find important dimensions below, configurations can be found on page 58.

HEIGHTS

60/30 Expo is available in heights 122 cm and 152 cm. Heights include adjustable feet (max. 2.5 cm). The shelves are adjustable in 2.5 cm increments.

WIDTHS

One bay is 130 cm wide.
Two bays are 220 cm wide.
Three bays are 310 cm wide.

DEPTHS

60/30 Expo is available with a shelf depth of 30 cm.

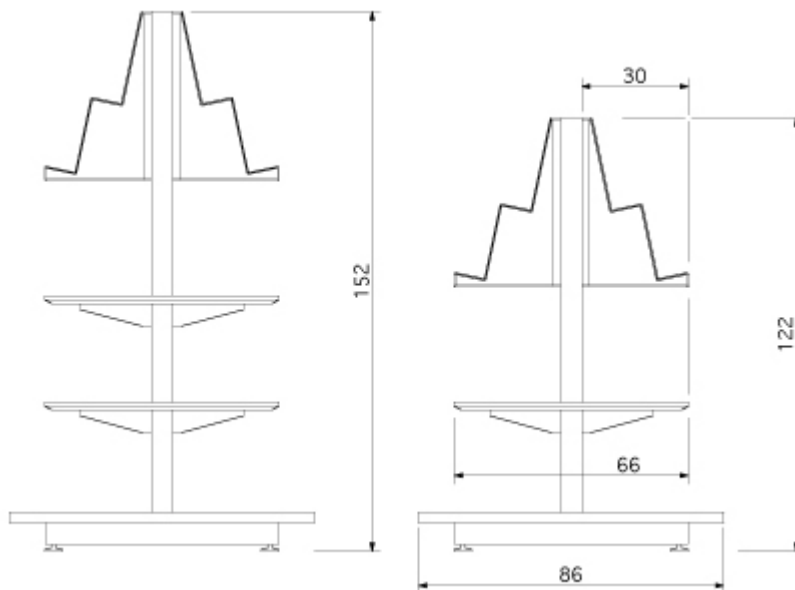

DIMENSIONS

60/30 CLASSIC ROUND

Please find important dimensions below, configurations can be found on page 164.

HEIGHTS

60/30 Classic Round Steel Shelving system is available in 5 heights; 92, 122, 152, 182 and 212 cm. Heights include adjustable feet (max. 2.5 cm). The shelves are adjustable in 2.5 cm increments.

WIDTHS

The bays are available as starter and add-on bays. A starter bay has two uprights and an add-on bay has one upright.

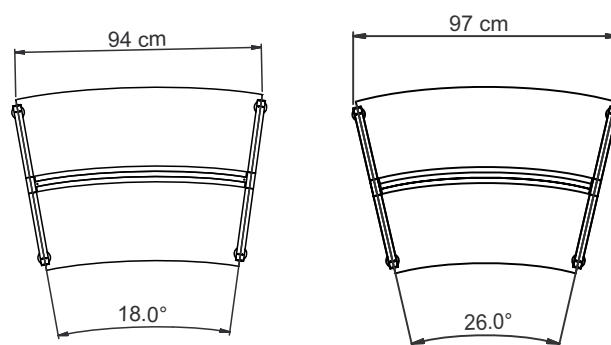
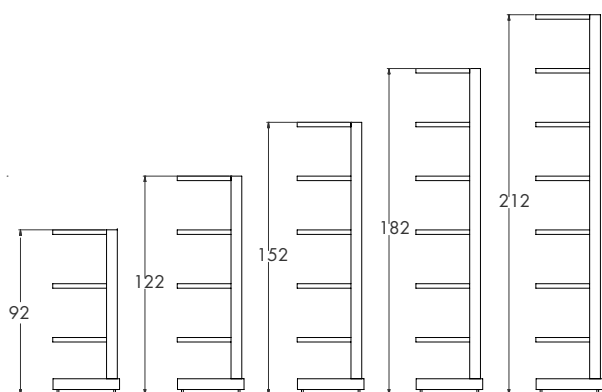

DEPTHS

The uprights come in one depth:
66 cm for 2 x 30 cm deep shelves

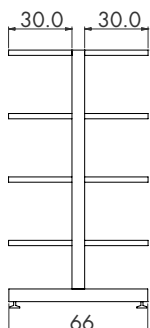

DIMENSIONS

60/30 CLASSIC ROUND

60/30 CLASSIC ROUND 26°

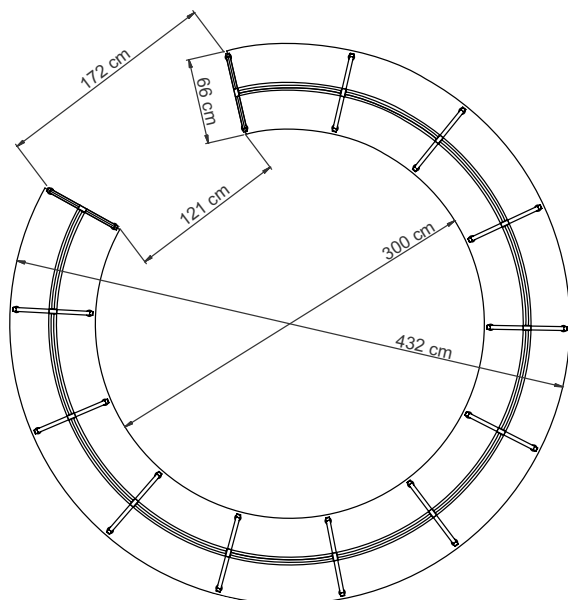

60/30 CLASSIC ROUND 18°

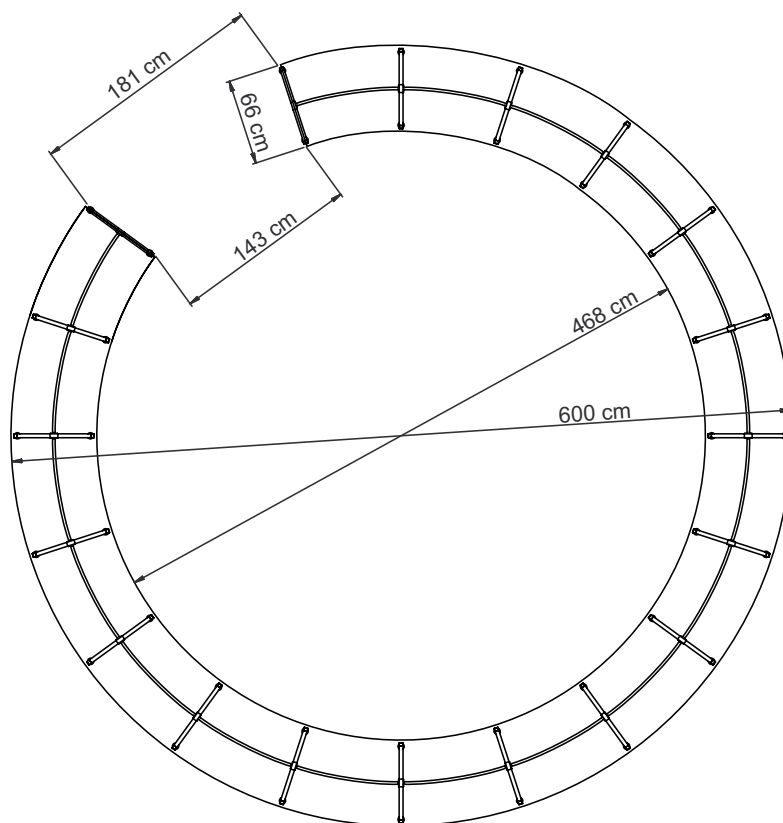

DIMENSIONS

60/30 CLASSIC LONDON TOP PLATE

LONDON WOODEN AND STEEL OVERLAYING TOP PLATES FOR STRAIGHT BAYS

If you build a shelving system with 1, 2 or 3 bays, then you can use just one freestanding top plate.

If you build a shelving system with more than 3 bays, then the overlaying top plates will be a combination of outer and intermediate overlaying top plates.

Freestanding wooden overlaying top plate

Is always used for 1 bay and can be used for 1, 2 or 3 bays. The overlaying top plate covers the end panels in both ends.

Total width mm			
Module	750	900	1000
1 bay	816	966	1071
2 bays	1566	1866	2071
3 bays	2316	2766	3071

Freestanding steel overlaying top plate

Is always used for 1 bay and can be used for up to 2 bays for London Steel. The overlaying top plate fits in between both end panels.

Total width mm			
Module	750	900	1000
1 bay	755	905	1010
2 bays	1505	1805	2010
3 bays	-	-	-

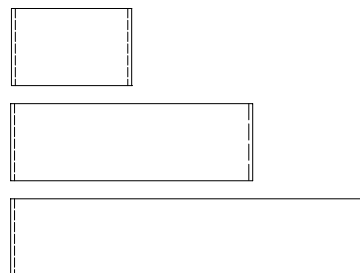

Outer wooden overlaying top plate

Can be used for 1, 2 or 3 bays in combination with either outer or intermediate overlaying top plates. The overlaying top plate covers one end panel.

Total width mm			
Module	750	900	1000
1 bay	783	933	1038
2 bays	1533	1833	2038
3 bays	2283	2733	3038

Outer steel overlaying top plate

Can be used for 1 and 2 bays in combination with either outer or intermediate overlaying top plates. The overlaying top plate is placed in between the end panel and outer/intermediate top plate.

Total width mm			
Module	750	900	1000
1 bay	753	903	1008
2 bays	1503	1803	2008
3 bays	-	-	-

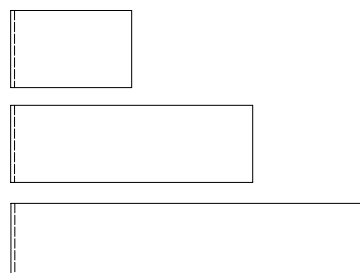

Intermediate wooden overlaying top plate

Can be used for 1, 2 or 3 bays in combination with either outer or intermediate overlaying top plates. The overlaying top plate is placed next to the outer/intermediate overlaying top plate.

Total width mm			
Module	750	900	1000
1 bay	751	901	1006
2 bays	1501	1801	2006
3 bays	2251	2701	3006

Intermediate steel overlaying top plate

Can be used for 1 and 2 bays in combination with either outer or intermediate overlaying top plates. The overlaying top plate is placed next to the outer/intermediate overlaying top plate.

Total width mm			
Module	750	900	1000
1 bay	750	900	1005
2 bays	1500	1800	2005
3 bays	-	-	-

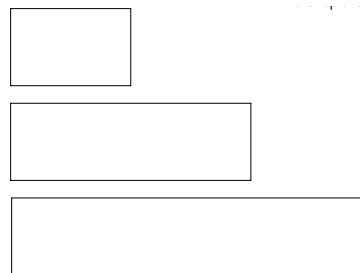

DIMENSIONS

60/30 CLASSIC ROUND LONDON TOP PLATE

LONDON WOODEN OVERLAYING TOP PLATES FOR ROUND BAYS

Use a freestanding or a combination of outer and intermediate wooden London top plates for your shelving system.

Freestanding wooden overlaying top plate

Is always used for 1 bay. The overlaying top plate covers the end panels in both ends.

Dimensions mm				
Bay	26°x	26°y	18°x	18°y
1 bay	1040	724	1006	707

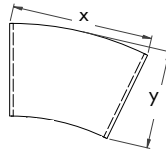

Outer wooden overlaying top plate

Can be used in combination with either outer or intermediate top plates. The overlaying top plate covers one end panel.

Dimensions mm				
Bay	26°x	26°y	18°x	18°y
1 bay	1008	724	974	707

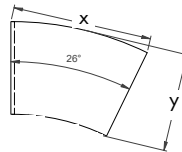

Intermediate wooden overlaying top plate

Can be used in combination with either outer or intermediate top plates. The overlaying top plate is placed next to the outer/intermediate overlaying top plate.

Dimensions mm				
Bay	26°x	26°y	18°x	18°y
1 bay	976	716	941	707

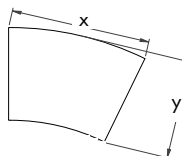

DIMENSIONS

END PANEL BAYS FOR DOUBLE-SIDED 60/30 CLASSIC STEEL SHELVING

Please find important dimensions below, configurations can be found on page 150 and 186.

HEIGHTS

The end panel bays comes in 5 heights for double-sided shelving with/without London wooden top plate. Heights include adjustable feet. The shelves are adjustable in 2.5 cm increments.

For double-sided shelving

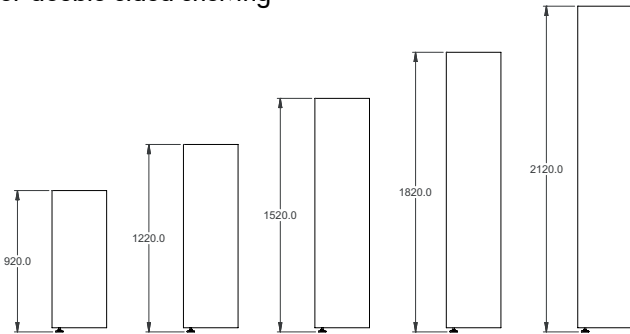

For double-sided shelving with overlaying London wooden top plate

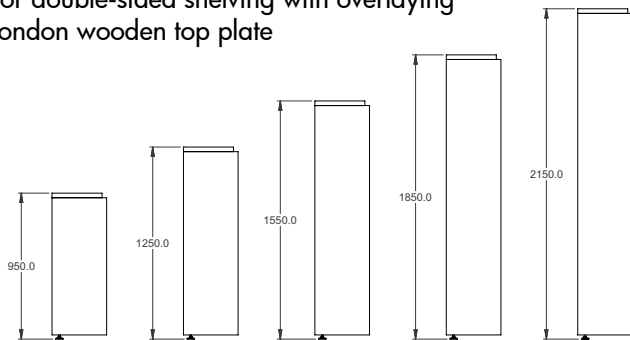

WIDTHS

The width of the end panel bays depend on the depth of the double-sided shelving system they are mounted on:

52,8 cm - for 22,5/22,5 cm shelving

57,8 cm - for 25/25 cm shelving

67,8 cm - for 30/30 cm shelving

87,8 cm - for 40/40 cm shelving

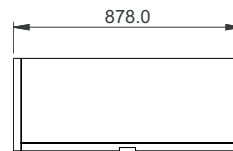
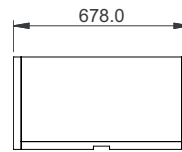
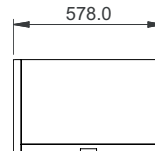
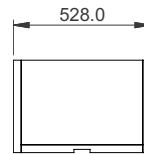

DEPTHS

The end panel bays come in 2 depths:

30,5 cm - for 25 cm deep shelves

35,5 cm - for 30 cm deep shelves

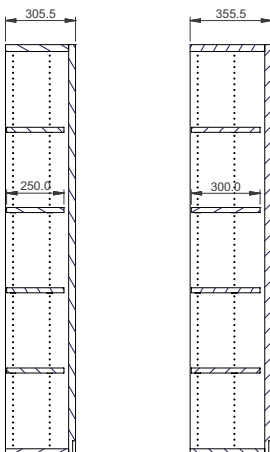



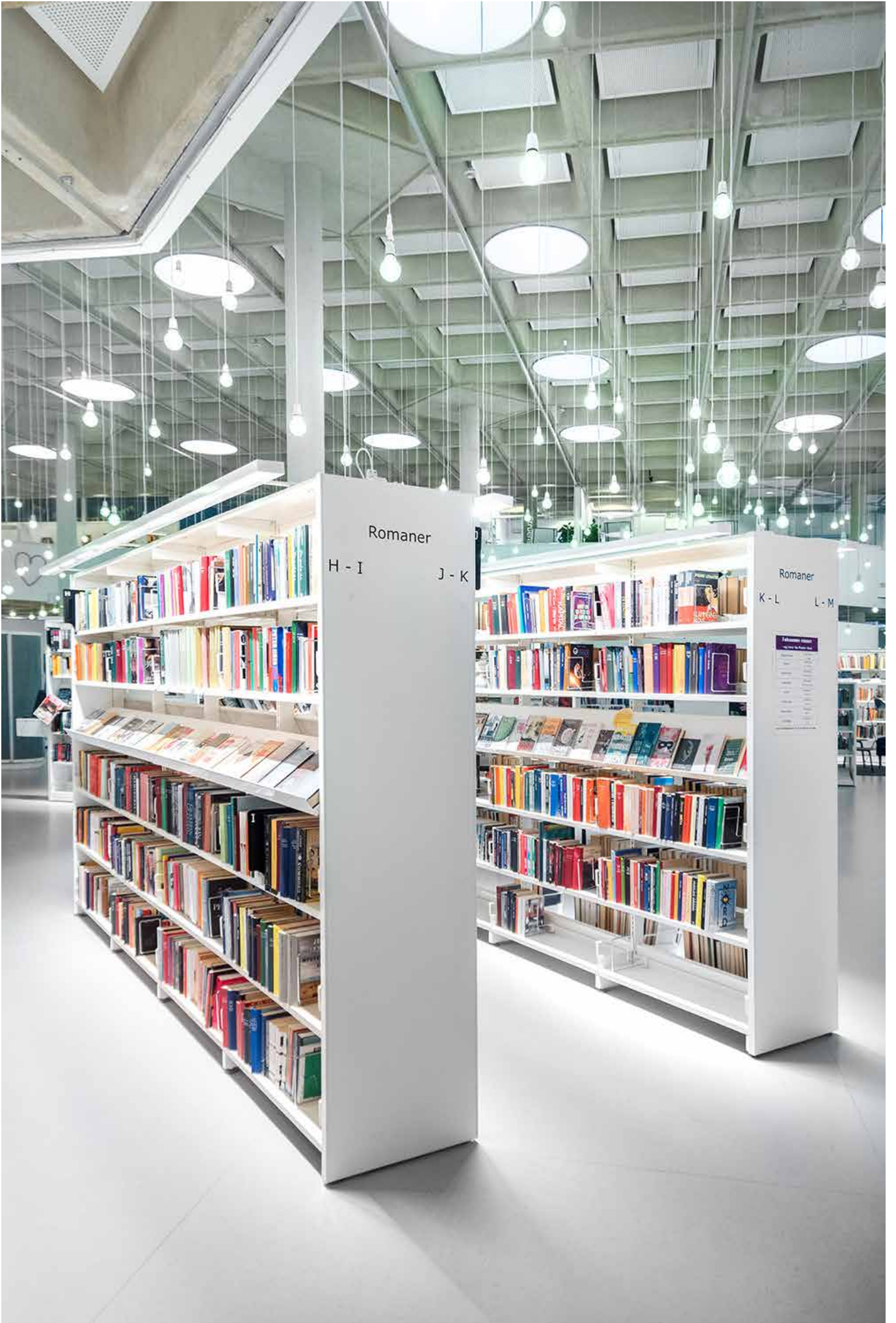

60/30 CLASSIC

The following pages will show basic configurations of the 60/30 Classic Steel Shelving system.



60/30 CLASSIC

SINGLE-SIDED - WITHOUT SHELVES

Configurations with uprights, crossbars, fittings and wall securement. Find shelves from page 66.

Height 92 cm

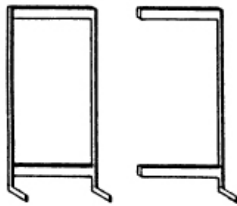

Module cm	Shelf depth cm	Item no. Starter bay	Price EUR	Item no. Add-on bay	Price EUR
75	22.5	BB301007171000	379,04	BB301017171000	250,43
75	25	BB301007271000	390,74	BB301017271000	256,28
75	30	BB301007371000	393,94	BB301017371000	257,88
75	40	BB301007471000	401,66	BB301017471000	261,74
90	22.5	BB301007191000	389,68	BB301017191000	261,07
90	25	BB301007291000	401,38	BB301017291000	266,92
90	30	BB301007391000	404,58	BB301017391000	268,52
90	40	BB301007491000	412,30	BB301017491000	272,38
100	22.5	BB301007111000	401,40	BB301017111000	272,79
100	25	BB301007211000	413,10	BB301017211000	278,64
100	30	BB301007311000	416,30	BB301017311000	280,24
100	40	BB301007411000	424,02	BB301017411000	284,10

Height 122 cm

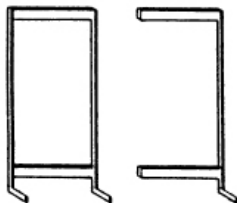

Module cm	Shelf depth cm	Item no. Starter bay	Price EUR	Item no. Add-on bay	Price EUR
75	22.5	BB301002171000	407,78	BB301012171000	264,80
75	25	BB301002271000	419,74	BB301012271000	270,78
75	30	BB301002371000	423,74	BB301012371000	272,78
75	40	BB301002471000	431,98	BB301012471000	276,90
90	22.5	BB301002191000	418,42	BB301012191000	275,44
90	25	BB301002291000	430,38	BB301012291000	281,42
90	30	BB301002391000	434,38	BB301012391000	283,42
90	40	BB301002491000	442,62	BB301012491000	287,54
100	22.5	BB301002111000	430,14	BB301012111000	287,16
100	25	BB301002211000	442,10	BB301012211000	293,14
100	30	BB301002311000	446,10	BB301012311000	295,14
100	40	BB301002411000	454,34	BB301012411000	299,26

Height 152 cm

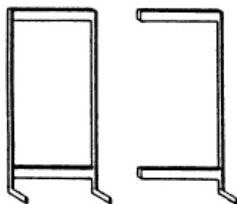

Module cm	Shelf depth cm	Item no. Starter bay	Price EUR	Item no. Add-on bay	Price EUR
75	22.5	BB301005171000	438,36	BB301015171000	280,09
75	25	BB301005271000	445,02	BB301015271000	283,42
75	30	BB301005371000	449,54	BB301015371000	285,68
75	40	BB301005471000	455,92	BB301015471000	288,87
90	22.5	BB301005191000	449,00	BB301015191000	290,73
90	25	BB301005291000	455,66	BB301015291000	294,06
90	30	BB301005391000	460,18	BB301015391000	296,32
90	40	BB301005491000	466,56	BB301015491000	299,51
100	22.5	BB301005111000	460,72	BB301015111000	302,45
100	25	BB301005211000	467,38	BB301015211000	305,78
100	30	BB301005311000	471,90	BB301015311000	308,04
100	40	BB301005411000	478,28	BB301015411000	311,23

60/30 CLASSIC

SINGLE-SIDED - WITHOUT SHELVES

Configurations with uprights, crossbars, fittings and wall securement. Find shelves from page 66.

Height 182 cm

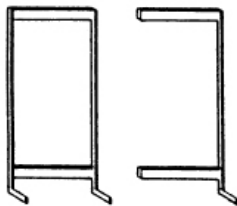

Module cm	Shelf depth cm	Item no. Starter bay	Price EUR	Item no. Add-on bay	Price EUR
75	22.5	BB301008171000	466,56	BB301018171000	294,19
75	25	BB301008271000	471,08	BB301018271000	296,45
75	30	BB301008371000	475,86	BB301018371000	298,84
75	40	BB301008471000	485,70	BB301018471000	303,76
90	22.5	BB301008191000	477,20	BB301018191000	304,83
90	25	BB301008291000	481,72	BB301018291000	307,09
90	30	BB301008391000	486,50	BB301018391000	309,48
90	40	BB301008491000	496,34	BB301018491000	314,40
100	22.5	BB301008111000	488,92	BB301018111000	316,55
100	25	BB301008211000	493,44	BB301018211000	318,81
100	30	BB301008311000	498,22	BB301018311000	321,20
100	40	BB301008411000	508,06	BB301018411000	326,12

Height 212 cm

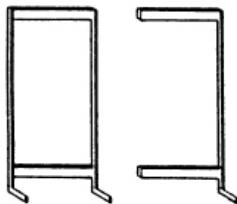

Module cm	Shelf depth cm	Item no. Starter bay	Price EUR	Item no. Add-on bay	Price EUR
75	22.5	BB301001171000	495,82	BB301011171000	308,82
75	25	BB301001271000	501,94	BB301011271000	311,88
75	30	BB301001371000	506,98	BB301011371000	314,40
75	40	BB301001471000	514,44	BB301011471000	318,13
90	22.5	BB301001191000	506,46	BB301011191000	319,46
90	25	BB301001291000	512,58	BB301011291000	322,52
90	30	BB301001391000	517,62	BB301011391000	325,04
90	40	BB301001491000	525,08	BB301011491000	328,77
100	22.5	BB301001111000	518,18	BB301011111000	331,18
100	25	BB301001211000	524,30	BB301011211000	334,24
100	30	BB301001311000	529,34	BB301011311000	336,76
100	40	BB301001411000	536,80	BB301011411000	340,49

60/30 CLASSIC

DOUBLE-SIDED - WITHOUT SHELVES

Configurations with uprights, crossbars and fittings. Find shelves from page 66.

Height 92 cm

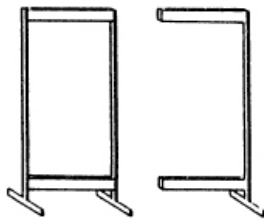

Module cm	Shelf depth cm	Item no. Starter bay	Price EUR	Item no. Add-on bay	Price EUR
75	22.5	BB301007172000	402,46	BB301017172000	262,14
75	25	BB301007272000	409,90	BB301017272000	265,86
75	30	BB301007372000	421,08	BB301017372000	271,45
75	40	BB301007472000	433,04	BB301017472000	277,43
90	22.5	BB301007192000	413,10	BB301017192000	272,78
90	25	BB301007292000	420,54	BB301017292000	276,50
90	30	BB301007392000	431,72	BB301017392000	282,09
90	40	BB301007492000	443,68	BB301017492000	288,07
100	22.5	BB301007112000	424,82	BB301017112000	284,50
100	25	BB301007212000	432,26	BB301017212000	288,22
100	30	BB301007312000	443,44	BB301017312000	293,81
100	40	BB301007412000	455,40	BB301017412000	299,79

Height 122 cm

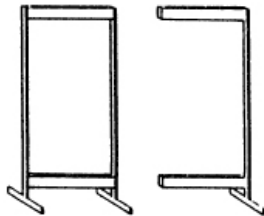

Module cm	Shelf depth cm	Item no. Starter bay	Price EUR	Item no. Add-on bay	Price EUR
75	22.5	BB301002172000	434,10	BB301012172000	277,96
75	25	BB301002272000	442,62	BB301012272000	282,22
75	30	BB301002372000	455,12	BB301012372000	288,47
75	40	BB301002472000	466,56	BB301012472000	294,19
90	22.5	BB301002192000	444,74	BB301012192000	288,60
90	25	BB301002292000	453,26	BB301012292000	292,86
90	30	BB301002392000	465,76	BB301012392000	299,11
90	40	BB301002492000	477,20	BB301012492000	304,83
100	22.5	BB301002112000	456,46	BB301012112000	300,32
100	25	BB301002212000	464,98	BB301012212000	304,58
100	30	BB301002312000	477,48	BB301012312000	310,83
100	40	BB301002412000	488,92	BB301012412000	316,55

Height 152 cm

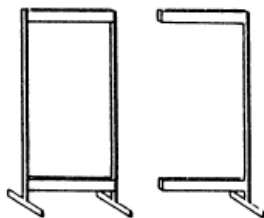

Module cm	Shelf depth cm	Item no. Starter bay	Price EUR	Item no. Add-on bay	Price EUR
75	22.5	BB301005172000	470,82	BB301015172000	296,32
75	25	BB301005272000	478,52	BB301015272000	300,17
75	30	BB301005372000	486,50	BB301015372000	304,16
75	40	BB301005472000	506,20	BB301015472000	314,01
90	22.5	BB301005192000	481,46	BB301015192000	306,96
90	25	BB301005292000	489,16	BB301015292000	310,81
90	30	BB301005392000	497,14	BB301015392000	314,80
90	40	BB301005492000	516,84	BB301015492000	324,65
100	22.5	BB301005112000	493,18	BB301015112000	318,68
100	25	BB301005212000	500,88	BB301015212000	322,53
100	30	BB301005312000	508,86	BB301015312000	326,52
100	40	BB301005412000	528,56	BB301015412000	336,37

60/30 CLASSIC

DOUBLE-SIDED - WITHOUT SHELVES

Configurations with uprights, crossbars and fittings. Find shelves from page 66.

Height 182 cm

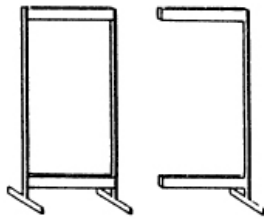

Module cm	Shelf depth cm	Item no. Starter bay	Price EUR	Item no. Add-on bay	Price EUR
75	22.5	BB301008172000	486,50	BB301018172000	304,16
75	25	BB301008272000	502,74	BB301018272000	312,28
75	30	BB301008372000	513,38	BB301018372000	317,60
75	40	BB301008472000	532,26	BB301018472000	327,04
90	22.5	BB301008192000	497,14	BB301018192000	314,80
90	25	BB301008292000	513,38	BB301018292000	322,92
90	30	BB301008392000	524,02	BB301018392000	328,24
90	40	BB301008492000	542,90	BB301018492000	337,68
100	22.5	BB301008112000	508,86	BB301018112000	326,52
100	25	BB301008212000	525,10	BB301018212000	334,64
100	30	BB301008312000	535,74	BB301018312000	339,96
100	40	BB301008412000	554,62	BB301018412000	349,40

Height 212 cm

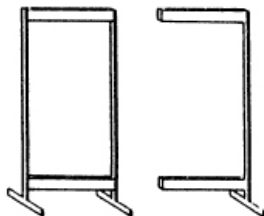

Module cm	Shelf depth cm	Item no. Starter bay	Price EUR	Item no. Add-on bay	Price EUR
75	22.5	BB301001172000	528,54	BB301011172000	325,18
75	25	BB301001272000	534,12	BB301011272000	327,97
75	30	BB301001372000	538,12	BB301011372000	329,97
75	40	BB301001472000	556,74	BB301011472000	339,28
90	22.5	BB301001192000	539,18	BB301011192000	335,82
90	25	BB301001292000	544,76	BB301011292000	338,61
90	30	BB301001392000	548,76	BB301011392000	340,61
90	40	BB301001492000	567,38	BB301011492000	349,92
100	22.5	BB301001112000	550,90	BB301011112000	347,54
100	25	BB301001212000	556,48	BB301011212000	350,33
100	30	BB301001312000	560,48	BB301011312000	352,33
100	40	BB301001412000	579,10	BB301011412000	361,64

60/30 CLASSIC

SINGLE-SIDED - WITH SHELVES - WITHOUT TOP SHELF

Complete shelving system with uprights, crossbars, shelves, brackets, fittings and wall securement. Shelves are steel shelves with backedge. Number of shelves are calculated for optimal shelf spacing for fiction. A starter bay is delivered with one right and one left bracket per shelf. An add-on bay is delivered with a double bracket per shelf, which places the shelves in the same height as that of the starter bay.

Height 92 cm (2 shelves)

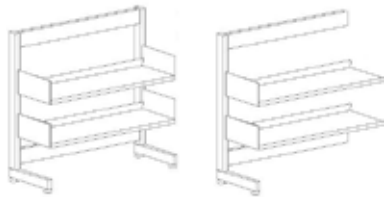

Module cm	Shelf depth cm	Item no. Starter bay	Price EUR	Item no. Add-on bay	Price EUR
75	22.5	BB301007171120	529,88	BB301017171120	378,11
75	25	BB301007271120	555,38	BB301017271120	392,20
75	30	BB301007371120	567,40	BB301017371120	402,86
75	40	BB301007471120	611,00	BB301017471120	437,04
90	22.5	BB301007191120	551,16	BB301017191120	399,39
90	25	BB301007291120	572,40	BB301017291120	409,22
90	30	BB301007391120	587,60	BB301017391120	423,06
90	40	BB301007491120	645,32	BB301017491120	471,36
100	22.5	BB301007111120	573,52	BB301017111120	421,75
100	25	BB301007211120	598,22	BB301017211120	435,04
100	30	BB301007311120	611,56	BB301017311120	447,02
100	40	BB301007411120	662,88	BB301017411120	488,92

Height 122 cm (3 shelves)

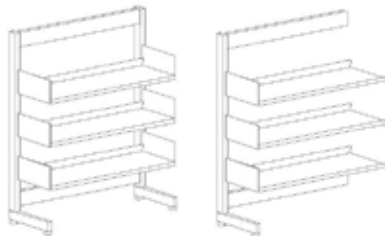

Module cm	Shelf depth cm	Item no. Starter bay	Price EUR	Item no. Add-on bay	Price EUR
75	22.5	BB301002171130	634,04	BB301012171130	456,32
75	25	BB301002271130	666,70	BB301012271130	474,66
75	30	BB301002371130	683,93	BB301012371130	490,25
75	40	BB301002471130	745,99	BB301012471130	539,85
90	22.5	BB301002191130	660,64	BB301012191130	482,92
90	25	BB301002291130	686,91	BB301012291130	494,87
90	30	BB301002391130	708,91	BB301012391130	515,23
90	40	BB301002491130	792,15	BB301012491130	586,01
100	22.5	BB301002111130	688,32	BB301012111130	510,60
100	25	BB301002211130	719,78	BB301012211130	527,74
100	30	BB301002311130	738,99	BB301012311130	545,31
100	40	BB301002411130	812,63	BB301012411130	606,49

Height 152 cm (4 shelves)

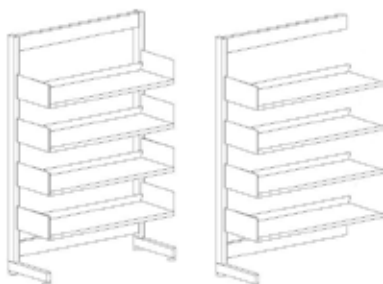

Module cm	Shelf depth cm	Item no. Starter bay	Price EUR	Item no. Add-on bay	Price EUR
75	22.5	BB301005171140	740,04	BB301015171140	535,45
75	25	BB301005271140	774,30	BB301015271140	555,26
75	30	BB301005371140	796,46	BB301015371140	575,64
75	40	BB301005471140	874,60	BB301015471140	639,47
90	22.5	BB301005191140	771,96	BB301015191140	567,37
90	25	BB301005291140	797,70	BB301015291140	578,66
90	30	BB301005391140	826,22	BB301015391140	605,40
90	40	BB301005491140	932,60	BB301015491140	697,47
100	22.5	BB301005111140	804,96	BB301015111140	600,37
100	25	BB301005211140	837,62	BB301015211140	618,58
100	30	BB301005311140	862,42	BB301015311140	641,60
100	40	BB301005411140	956,00	BB301015411140	720,87

60/30 CLASSIC

SINGLE-SIDED - WITH SHELVES - WITHOUT TOP SHELF

Complete shelving system with uprights, crossbars, shelves, brackets, fittings and wall securement. Shelves are steel shelves with backedge. Number of shelves are calculated for optimal shelf spacing for fiction. A starter bay is delivered with one right and one left bracket per shelf. An add-on bay is delivered with a double bracket per shelf, which places the shelves in the same height as that of the starter bay.

Height 182 cm (5 shelves)

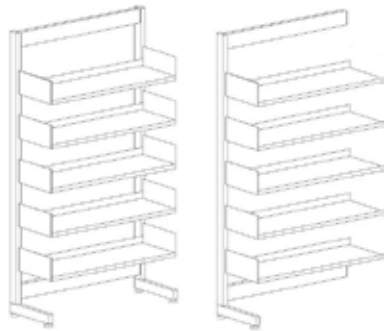

Module cm	Shelf depth cm	Item no. Starter bay	Price EUR	Item no. Add-on bay	Price EUR
75	22.5	BB301008171150	843,66	BB301018171150	613,39
75	25	BB301008271150	882,68	BB301018271150	636,25
75	30	BB301008371150	909,51	BB301018371150	661,29
75	40	BB301008471150	1.009,05	BB301018471150	742,01
90	22.5	BB301008191150	880,90	BB301018191150	650,63
90	25	BB301008291150	909,27	BB301018291150	662,84
90	30	BB301008391150	944,05	BB301018391150	695,83
90	40	BB301008491150	1.078,89	BB301018491150	811,85
100	22.5	BB301008111150	919,22	BB301018111150	688,95
100	25	BB301008211150	956,24	BB301018211150	709,81
100	30	BB301008311150	986,37	BB301018311150	738,15
100	40	BB301008411150	1.105,21	BB301018411150	838,17

Height 212 cm (6 shelves)

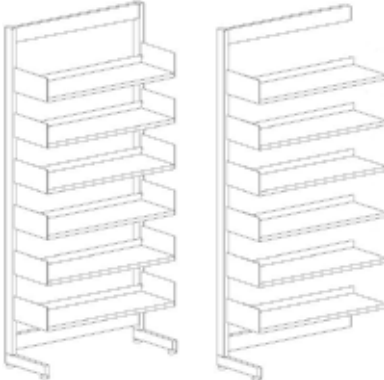

Module cm	Shelf depth cm	Item no. Starter bay	Price EUR	Item no. Add-on bay	Price EUR
75	22.5	BB301001171160	948,34	BB301011171160	691,86
75	25	BB301001271160	995,86	BB301011271160	719,64
75	30	BB301001371160	1.027,36	BB301011371160	749,34
75	40	BB301001471160	1.142,46	BB301011471160	844,03
90	22.5	BB301001191160	990,90	BB301011191160	734,42
90	25	BB301001291160	1.025,64	BB301011291160	749,42
90	30	BB301001391160	1.066,68	BB301011391160	788,66
90	40	BB301001491160	1.224,14	BB301011491160	925,71
100	22.5	BB301001111160	1.034,54	BB301011111160	778,06
100	25	BB301001211160	1.079,66	BB301011211160	803,44
100	30	BB301001311160	1.115,12	BB301011311160	837,10
100	40	BB301001411160	1.253,38	BB301011411160	954,95

60/30 CLASSIC

DOUBLE-SIDED - WITH SHELVES - WITHOUT TOP SHELF

Complete shelving system with uprights, crossbars, shelves, brackets and fittings. Shelves are steel shelves with backedge. Number of shelves are calculated for optimal shelf spacing for fiction. A starter bay is delivered with one right and one left bracket per shelf. An add-on bay is delivered with a double bracket per shelf, which places the shelves in the same height as that of the starter bay.

Height 92 cm (2 shelves on each side)

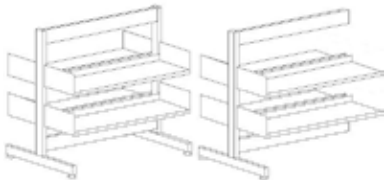
Module cm	Shelf depth cm	Item no. Starter bay	Price EUR	Item no. Add-on bay	Price EUR	
	75	22.5	BB301007172120	704,14	BB301017172120	517,50
	75	25	BB301007272120	739,18	BB301017272120	537,70
	75	30	BB301007372120	768,00	BB301017372120	561,41
	75	40	BB301007472120	851,72	BB301017472120	628,03
	90	22.5	BB301007192120	736,06	BB301017192120	549,42
	90	25	BB301007292120	762,58	BB301017292120	561,10
	90	30	BB301007392120	797,76	BB301017392120	591,17
	90	40	BB301007492120	909,72	BB301017492120	686,03
	100	22.5	BB301007112120	769,06	BB301017112120	582,42
	100	25	BB301007212120	802,50	BB301017212120	601,02
	100	30	BB301007312120	833,96	BB301017312120	627,37
	100	40	BB301007412120	933,12	BB301017412120	709,43

Height 122 cm (3 shelves on each side)

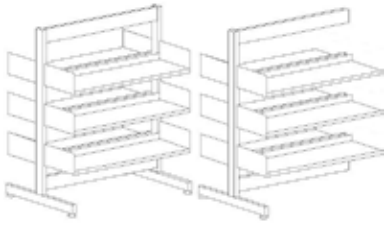
Module cm	Shelf depth cm	Item no. Starter bay	Price EUR	Item no. Add-on bay	Price EUR	
	75	22.5	BB301002172130	886,62	BB301012172130	661,00
	75	25	BB301002272130	936,54	BB301012272130	689,98
	75	30	BB301002372130	975,50	BB301012372130	723,41
	75	40	BB301002472130	1.094,58	BB301012472130	820,09
	90	22.5	BB301002192130	929,18	BB301012192130	703,56
	90	25	BB301002292130	966,32	BB301012292130	719,76
	90	30	BB301002392130	1.014,82	BB301012392130	762,73
	90	40	BB301002492130	1.176,26	BB301012492130	901,77
	100	22.5	BB301002112130	972,82	BB301012112130	747,20
	100	25	BB301002212130	1.020,34	BB301012212130	773,78
	100	30	BB301002312130	1.063,26	BB301012312130	811,17
	100	40	BB301002412130	1.205,50	BB301012412130	931,01

Height 152 cm (4 shelves on each side)

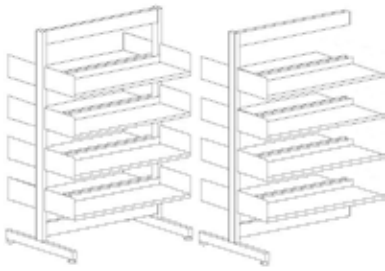
Module cm	Shelf depth cm	Item no. Starter bay	Price EUR	Item no. Add-on bay	Price EUR	
	75	22.5	BB301005172140	1.074,18	BB301015172140	807,04
	75	25	BB301005272140	1.137,08	BB301015272140	843,85
	75	30	BB301005372140	1.180,34	BB301015372140	884,08
	75	40	BB301005472140	1.343,56	BB301015472140	1.015,21
	90	22.5	BB301005192140	1.127,38	BB301015192140	860,24
	90	25	BB301005292140	1.173,24	BB301015292140	880,01
	90	30	BB301005392140	1.229,22	BB301015392140	932,96
	90	40	BB301005492140	1.448,92	BB301015492140	1.120,57
	100	22.5	BB301005112140	1.181,66	BB301015112140	914,52
	100	25	BB301005212140	1.241,36	BB301015212140	948,13
	100	30	BB301005312140	1.289,90	BB301015312140	993,64
	100	40	BB301005412140	1.484,00	BB301015412140	1.155,65

60/30 CLASSIC

DOUBLE-SIDED - WITH SHELVES - WITHOUT TOP SHELF

Complete shelving system with uprights, crossbars, shelves, brackets and fittings. Shelves are steel shelves with backedge. Number of shelves are calculated for optimal shelf spacing for fiction. A starter bay is delivered with one right and one left bracket per shelf. An add-on bay is delivered with a double bracket per shelf, which places the shelves in the same height as that of the starter bay.

Height 182 cm (5 shelves on each side)

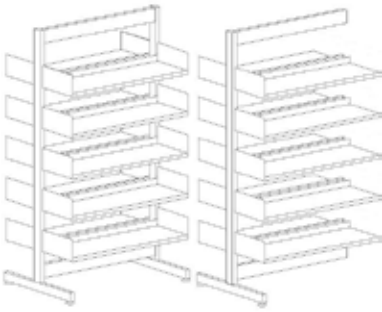
	Module cm	Shelf depth cm	Item no.	Price	Item no.	Price
			Starter bay	EUR	Add-on bay	EUR
	75	22.5	BB301008172150	1.240,70	BB301018172150	942,56
	75	25	BB301008272150	1.325,94	BB301018272150	991,88
	75	30	BB301008372150	1.380,68	BB301018372150	1.042,50
	75	40	BB301008472150	1.578,96	BB301018472150	1.203,54
	90	22.5	BB301008192150	1.304,54	BB301018192150	1.006,40
	90	25	BB301008292150	1.368,48	BB301018292150	1.034,42
	90	30	BB301008392150	1.439,12	BB301018392150	1.100,94
	90	40	BB301008492150	1.708,00	BB301018492150	1.332,58
	100	22.5	BB301008112150	1.369,46	BB301018112150	1.071,32
	100	25	BB301008212150	1.450,70	BB301018212150	1.116,64
	100	30	BB301008312150	1.512,04	BB301018312150	1.173,86
	100	40	BB301008412150	1.748,92	BB301018412150	1.373,50

Height 212 cm (6 shelves on each side)

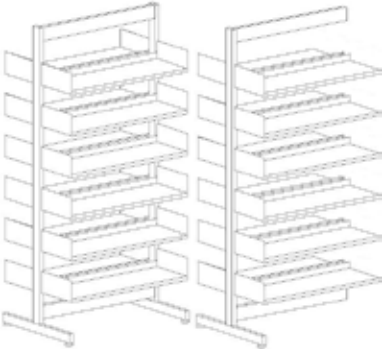
	Module cm	Shelf depth cm	Item no.	Price	Item no.	Price
			Starter bay	EUR	Add-on bay	EUR
	75	22.5	BB301001172160	1.433,58	BB301011172160	1.091,26
	75	25	BB301001272160	1.521,96	BB301011272160	1.143,49
	75	30	BB301001372160	1.578,88	BB301011372160	1.199,85
	75	40	BB301001472160	1.812,78	BB301011472160	1.391,08
	90	22.5	BB301001192160	1.508,06	BB301011192160	1.165,74
	90	25	BB301001292160	1.570,88	BB301011292160	1.192,41
	90	30	BB301001392160	1.646,88	BB301011392160	1.267,85
	90	40	BB301001492160	1.965,50	BB301011492160	1.543,80
	100	22.5	BB301001112160	1.583,62	BB301011112160	1.241,30
	100	25	BB301001212160	1.667,20	BB301011212160	1.288,73
	100	30	BB301001312160	1.732,04	BB301011312160	1.353,01
	100	40	BB301001412160	2.012,26	BB301011412160	1.590,56

60/30 CLASSIC

SINGLE-SIDED - WITH SHELVES AND TOP SHELF

Complete shelving system with uprights, crossbars, shelves, top shelf, brackets, fittings and wall securement. Shelves are steel shelves with backedge, top shelf is steel shelf without backedge. Number of shelves are calculated for optimal shelf spacing for fiction. A starter bay is delivered with one right and one left bracket per shelf. An add-on bay is delivered with a double bracket per shelf, which places the shelves in the same height as that of the starter bay.

Height 92 cm (2 shelves + top shelf)

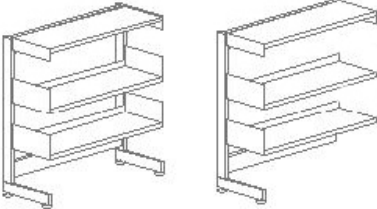
	Module cm	Shelf depth cm	Item no.	Price	Item no.	Price
			Starter bay	EUR	Add-on bay	EUR
	75	22.5	BB301007171121	612,73	BB301017171121	446,74
	75	25	BB301007271121	639,57	BB301017271121	462,16
	75	30	BB301007371121	660,24	BB301017371121	481,46
	75	40	BB301007471121	716,33	BB301017471121	526,81
	90	22.5	BB301007191121	635,88	BB301017191121	469,89
	90	25	BB301007291121	662,84	BB301017291121	485,43
	90	30	BB301007391121	683,50	BB301017391121	504,72
	90	40	BB301007491121	760,50	BB301017491121	570,98
	100	22.5	BB301007111121	667,01	BB301017111121	501,02
	100	25	BB301007211121	695,97	BB301017211121	518,56
	100	30	BB301007311121	713,58	BB301017311121	534,80
	100	40	BB301007411121	782,45	BB301017411121	592,93

Height 122 cm (3 shelves + top shelf)

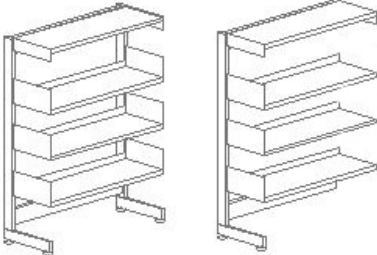
	Module cm	Shelf depth cm	Item no.	Price	Item no.	Price
			Starter bay	EUR	Add-on bay	EUR
	75	22.5	BB301002171131	716,89	BB301012171131	524,95
	75	25	BB301002271131	750,89	BB301012271131	544,62
	75	30	BB301002371131	776,77	BB301012371131	568,85
	75	40	BB301002471131	851,32	BB301012471131	629,62
	90	22.5	BB301002191131	745,36	BB301012191131	553,42
	90	25	BB301002291131	777,35	BB301012291131	571,08
	90	30	BB301002391131	804,81	BB301012391131	596,89
	90	40	BB301002491131	907,33	BB301012491131	685,63
	100	22.5	BB301002111131	781,81	BB301012111131	589,87
	100	25	BB301002211131	817,53	BB301012211131	611,26
	100	30	BB301002311131	841,01	BB301012311131	633,09
	100	40	BB301002411131	932,20	BB301012411131	710,50

Height 152 cm (4 shelves + top shelf)

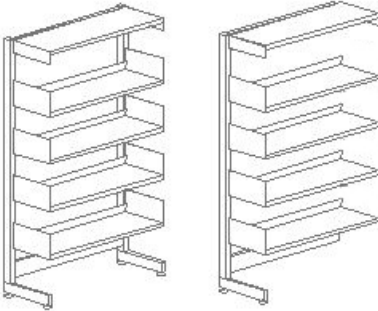
	Module cm	Shelf depth cm	Item no.	Price	Item no.	Price
			Starter bay	EUR	Add-on bay	EUR
	75	22.5	BB301005171141	822,89	BB301015171141	604,08
	75	25	BB301005271141	858,49	BB301015271141	625,22
	75	30	BB301005371141	889,30	BB301015371141	654,24
	75	40	BB301005471141	979,93	BB301015471141	729,24
	90	22.5	BB301005191141	856,68	BB301015191141	637,87
	90	25	BB301005291141	888,14	BB301015291141	654,87
	90	30	BB301005391141	922,12	BB301015391141	687,06
	90	40	BB301005491141	1.047,78	BB301015491141	797,09
	100	22.5	BB301005111141	898,45	BB301015111141	679,64
	100	25	BB301005211141	935,37	BB301015211141	702,10
	100	30	BB301005311141	964,44	BB301015311141	729,38
	100	40	BB301005411141	1.075,57	BB301015411141	824,88

60/30 CLASSIC

SINGLE-SIDED - WITH SHELVES AND TOP SHELF

Complete shelving system with uprights, crossbars, shelves, top shelf, brackets, fittings and wall securement. Shelves are steel shelves with backedge, top shelf is steel shelf without backedge. Number of shelves are calculated for optimal shelf spacing for fiction. A starter bay is delivered with one right and one left bracket per shelf. An add-on bay is delivered with a double bracket per shelf, which places the shelves in the same height as that of the starter bay.

Height 182 cm (5 shelves + top shelf)

	Module cm	Shelf depth cm	Item no.	Price	Item no.	Price
			Starter bay	EUR	Add-on bay	EUR
	75	22.5	BB301008171151	926,51	BB301018171151	682,02
	75	25	BB301008271151	966,87	BB301018271151	706,21
	75	30	BB301008371151	1.002,35	BB301018371151	739,89
	75	40	BB301008371151	1.002,35	BB301018471151	831,78
	90	22.5	BB301008191151	965,62	BB301018191151	721,13
	90	25	BB301008291151	999,71	BB301018291151	739,05
	90	30	BB301008391151	1.039,95	BB301018391151	777,49
	90	40	BB301008491151	1.194,07	BB301018491151	911,47
	100	22.5	BB301008111151	1.012,71	BB301018111151	768,22
	100	25	BB301008211151	1.053,99	BB301018211151	793,33
	100	30	BB301008311151	1.088,39	BB301018311151	825,93
	100	40	BB301008411151	1.224,78	BB301018411151	942,18

Height 212 cm (6 shelves + top shelf)

	Module cm	Shelf depth cm	Item no.	Price	Item no.	Price
			Starter bay	EUR	Add-on bay	EUR
	75	22.5	BB301001171161	1.031,19	BB301011171161	760,49
	75	25	BB301001271161	1.080,05	BB301011271161	789,60
	75	30	BB301001371161	1.120,20	BB301011371161	827,94
	75	40	BB301001471161	1.247,79	BB301011471161	933,80
	90	22.5	BB301001191161	1.075,62	BB301011191161	804,92
	90	25	BB301001291161	1.116,08	BB301011291161	825,63
	90	30	BB301001391161	1.162,58	BB301011391161	870,32
	90	40	BB301001491161	1.339,32	BB301011491161	1.025,33
	100	22.5	BB301001111161	1.128,03	BB301011111161	857,33
	100	25	BB301001211161	1.177,41	BB301011211161	886,96
	100	30	BB301001311161	1.217,14	BB301011311161	924,88
	100	40	BB301001411161	1.372,95	BB301011411161	1.058,96

60/30 CLASSIC

DOUBLE-SIDED - WITH SHELVES AND TOP SHELVES

Complete shelving system with uprights, crossbars, shelves, top shelf, brackets and fittings. Shelves are steel shelves with backedge, top shelf is steel shelf without backedge. Number of shelves are calculated for optimal shelf spacing for fiction. A starter bay is delivered with one right and one left bracket per shelf. An add-on bay is delivered with a double bracket per shelf, which places the shelves in the same height as that of the starter bay.

Height 92 cm (2 shelves + top shelf on each side)

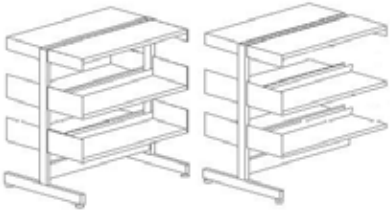
	Module cm	Shelf depth cm	Item no.	Price	Item no.	Price
			Starter bay	EUR	Add-on bay	EUR
	75	22.5	BB301007172121	869,84	BB301017172121	654,76
	75	25	BB301007272121	907,56	BB301017272121	677,62
	75	30	BB301007372121	953,68	BB301017372121	718,61
	75	40	BB301007472121	1.062,38	BB301017472121	807,57
	90	22.5	BB301007192121	905,50	BB301017192121	690,42
	90	25	BB301007292121	943,46	BB301017292121	713,52
	90	30	BB301007392121	989,56	BB301017392121	754,49
	90	40	BB301007492121	1.140,08	BB301017492121	885,27
	100	22.5	BB301007112121	956,04	BB301017112121	740,96
	100	25	BB301007212121	998,00	BB301017212121	768,06
	100	30	BB301007312121	1.038,00	BB301017312121	802,93
	100	40	BB301007412121	1.172,26	BB301017412121	917,45

Height 122 cm (3 shelves + top shelf on each side)

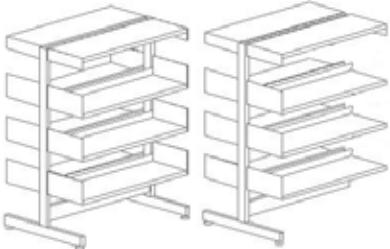
	Module cm	Shelf depth cm	Item no.	Price	Item no.	Price
			Starter bay	EUR	Add-on bay	EUR
	75	22.5	BB301002172131	1.052,32	BB301012172131	798,26
	75	25	BB301002272131	1.104,92	BB301012272131	829,90
	75	30	BB301002372131	1.161,18	BB301012372131	880,61
	75	40	BB301002472131	1.305,24	BB301012472131	999,63
	90	22.5	BB301002192131	1.098,62	BB301012192131	844,56
	90	25	BB301002292131	1.147,20	BB301012292131	872,18
	90	30	BB301002392131	1.206,62	BB301012392131	926,05
	90	40	BB301002492131	1.406,62	BB301012492131	1.101,01
	100	22.5	BB301002112131	1.159,80	BB301012112131	905,74
	100	25	BB301002212131	1.215,84	BB301012212131	940,82
	100	30	BB301002312131	1.267,30	BB301012312131	986,73
	100	40	BB301002412131	1.444,64	BB301012412131	1.139,03

Height 152 cm (4 shelves + top shelf on each side)

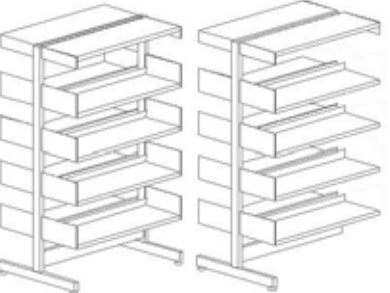
	Module cm	Shelf depth cm	Item no.	Price	Item no.	Price
			Starter bay	EUR	Add-on bay	EUR
	75	22.5	BB301005172141	1.239,88	BB301015172141	944,30
	75	25	BB301005272141	1.305,46	BB301015272141	983,77
	75	30	BB301005372141	1.366,02	BB301015372141	1.041,28
	75	40	BB301005472141	1.554,22	BB301015472141	1.194,75
	90	22.5	BB301005192141	1.296,82	BB301015192141	1.001,24
	90	25	BB301005292141	1.354,12	BB301015292141	1.032,43
	90	30	BB301005392141	1.421,02	BB301015392141	1.096,28
	90	40	BB301005492141	1.679,28	BB301015492141	1.319,81
	100	22.5	BB301005112141	1.368,64	BB301015112141	1.073,06
	100	25	BB301005212141	1.436,86	BB301015212141	1.115,17
	100	30	BB301005312141	1.493,94	BB301015312141	1.169,20
	100	40	BB301005412141	1.723,14	BB301015412141	1.363,67

60/30 CLASSIC

DOUBLE-SIDED - WITH SHELVES AND TOP SHELVES

Complete shelving system with uprights, crossbars, shelves, top shelf, brackets and fittings. Shelves are steel shelves with backedge, top shelf is steel shelf without backedge. Number of shelves are calculated for optimal shelf spacing for fiction. A starter bay is delivered with one right and one left bracket per shelf. An add-on bay is delivered with a double bracket per shelf, which places the shelves in the same height as that of the starter bay.

Height 182 cm (5 shelves + top shelf on each side)

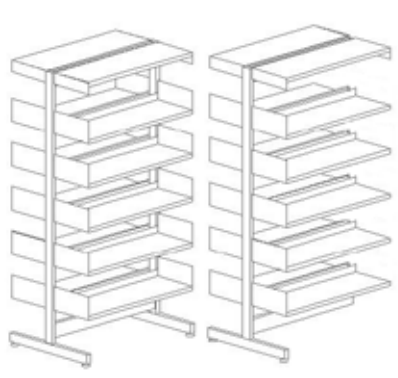
	Module cm	Shelf depth cm	Item no. Starter bay	Price EUR	Item no. Add-on bay	Price EUR
	75	22.5	BB301008172151	1.406,40	BB301018172151	1.079,82
	75	25	BB301008272151	1.494,32	BB301018272151	1.131,80
	75	30	BB301008372151	1.566,36	BB301018372151	1.199,70
	75	40	BB301008472151	1.789,62	BB301018472151	1.383,08
	90	22.5	BB301008192151	1.473,98	BB301018192151	1.147,40
	90	25	BB301008292151	1.549,36	BB301018292151	1.186,84
	90	30	BB301008392151	1.630,92	BB301018392151	1.264,26
	90	40	BB301008492151	1.938,36	BB301018492151	1.531,82
	100	22.5	BB301008112151	1.556,44	BB301018112151	1.229,86
	100	25	BB301008212151	1.646,20	BB301018212151	1.283,68
	100	30	BB301008312151	1.716,08	BB301018312151	1.349,42
	100	40	BB301008412151	1.988,06	BB301018412151	1.581,52

Height 212 cm (6 shelves + top shelf on each side)

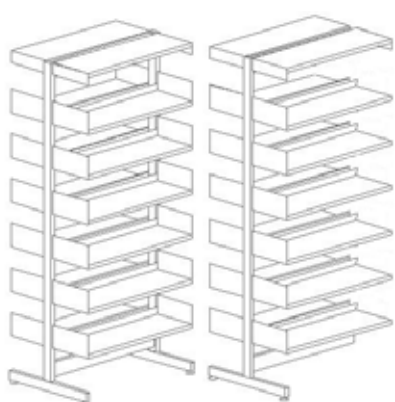
	Module cm	Shelf depth cm	Item no. Starter bay	Price EUR	Item no. Add-on bay	Price EUR
	75	22.5	BB301001172161	1.599,28	BB301011172161	1.228,52
	75	25	BB301001272161	1.690,34	BB301011272161	1.283,41
	75	30	BB301001372161	1.764,56	BB301011372161	1.357,05
	75	40	BB301001472161	2.023,44	BB301011472161	1.570,62
	90	22.5	BB301001192161	1.677,50	BB301011192161	1.306,74
	90	25	BB301001292161	1.751,76	BB301011292161	1.344,83
	90	30	BB301001392161	1.838,68	BB301011392161	1.431,17
	90	40	BB301001492161	2.195,86	BB301011492161	1.743,04
	100	22.5	BB301001112161	1.770,60	BB301011112161	1.399,84
	100	25	BB301001212161	1.862,70	BB301011212161	1.455,77
	100	30	BB301001312161	1.936,08	BB301011312161	1.528,57
	100	40	BB301001412161	2.251,40	BB301011412161	1.798,58

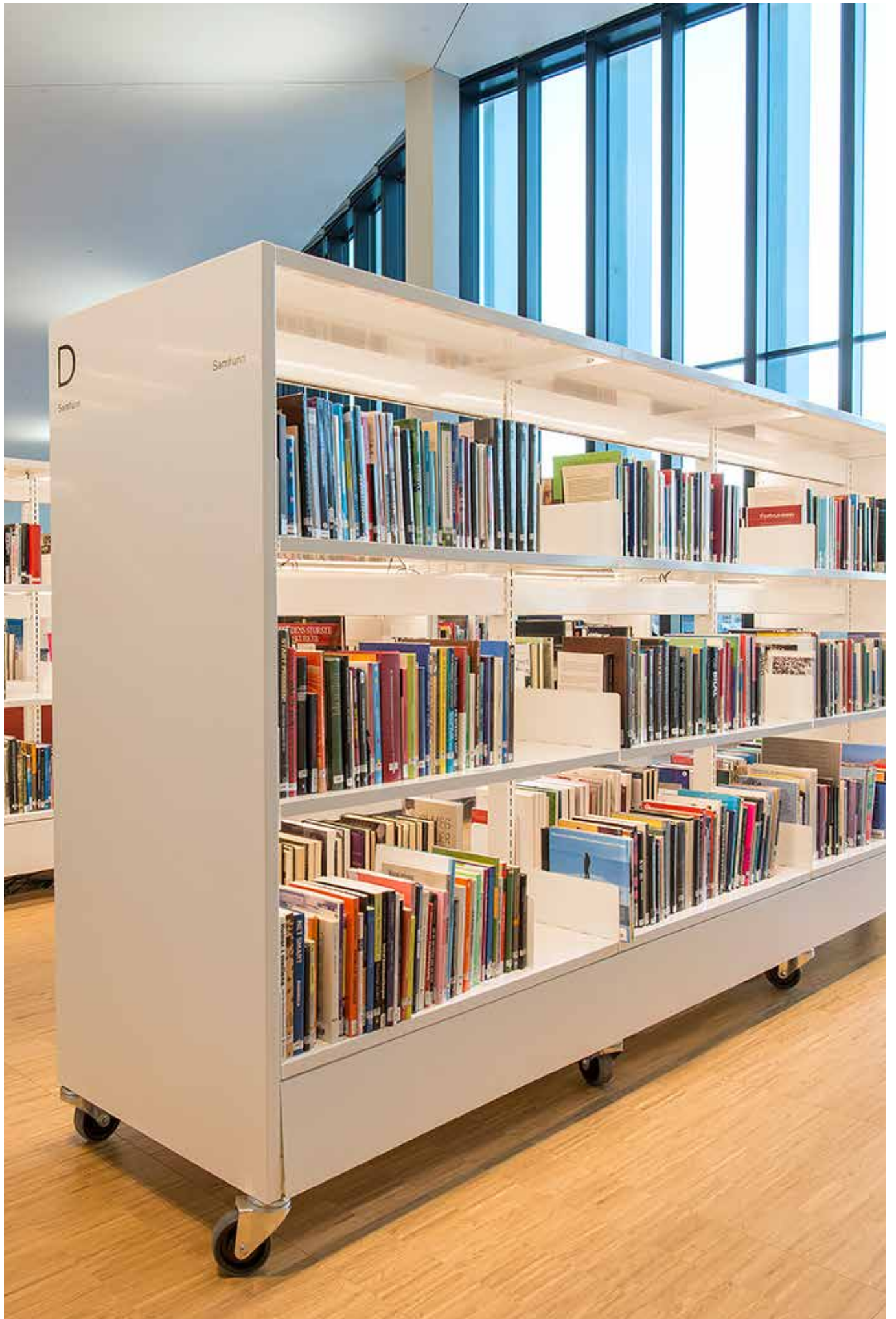

60/30 CLASSIC WITH LED

The following pages will show basic configurations of the 60/30 Classic Steel Shelving system with LED based on 60/30 upright installations.



60/30 CLASSIC WITH LED

SINGLE-SIDED - WITHOUT TOP SHELF AND WITH LED LIGHTING ON INTERMEDIATE SHELVES

Complete shelving system with uprights, cable channels, crossbars, steel shelves with backedge and LED lighting (see page 160 for details on LED lighting), brackets, fittings and wall securement. Cabling from bottom (cabling from above is an option, contact sales). Number of shelves are calculated for optimal shelf spacing for fiction. The LED light is placed underneath each shelf and the cable channel is placed on the left side of the bay. A starter bay is delivered with one right and one left bracket per shelf. An add-on bay is delivered with a double bracket per shelf, which places the shelves in the same height as that of the starter bay.

Height 92 cm (2 shelves and 1 LED light)

Please contact Sales for prices on 60/30 configurations with LED.

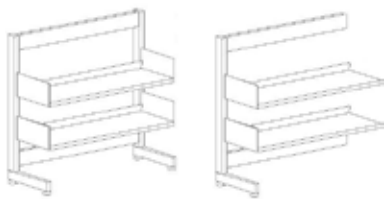

Module cm	Shelf depth cm	Item no. Starter bay	Price EUR	Item no. Add-on bay	Price EUR
75	22.5	BB30203717141120	-	BB30204717141120	-
75	25	BB30203727141120	-	BB30204727141120	-
75	30	BB30203737141120	-	BB30204737141120	-
75	40	BB30203747141120	-	BB30204747141120	-
90	22.5	BB30203719141120	-	BB30204719141120	-
90	25	BB30203729141120	-	BB30204729141120	-
90	30	BB30203739141120	-	BB30204739141120	-
90	40	BB30203749141120	-	BB30204749141120	-
100	22.5	BB30203711141120	-	BB30204711141120	-
100	25	BB30203721141120	-	BB30204721141120	-
100	30	BB30203731141120	-	BB30204731141120	-
100	40	BB30203741141120	-	BB30204741141120	-

Height 122 cm (3 shelves and 2 LED lights)

Please contact Sales for prices on 60/30 configurations with LED.

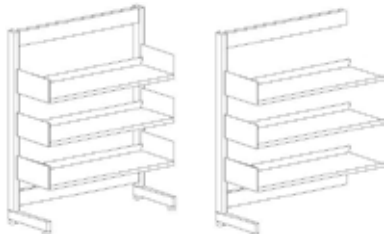

Module cm	Shelf depth cm	Item no. Starter bay	Price EUR	Item no. Add-on bay	Price EUR
75	22.5	BB30203217141130	-	BB30204217141130	-
75	25	BB30203227141130	-	BB30204227141130	-
75	30	BB30203237141130	-	BB30204237141130	-
75	40	BB30203247141130	-	BB30204247141130	-
90	22.5	BB30203219141130	-	BB30204219141130	-
90	25	BB30203229141130	-	BB30204229141130	-
90	30	BB30203239141130	-	BB30204239141130	-
90	40	BB30203249141130	-	BB30204249141130	-
100	22.5	BB30203211141130	-	BB30204211141130	-
100	25	BB30203221141130	-	BB30204221141130	-
100	30	BB30203231141130	-	BB30204231141130	-
100	40	BB30203241141130	-	BB30204241141130	-

Height 152 cm (4 shelves and and 3 LED lights)

Please contact Sales for prices on 60/30 configurations with LED.

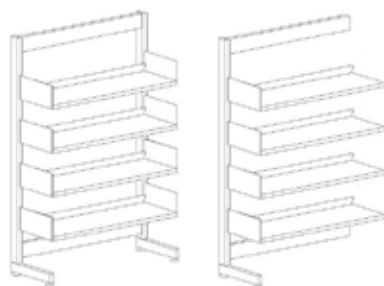

Module cm	Shelf depth cm	Item no. Starter bay	Price EUR	Item no. Add-on bay	Price EUR
75	22.5	BB30203517141140	-	BB30204517141140	-
75	25	BB30203527141140	-	BB30204527141140	-
75	30	BB30203537141140	-	BB30204537141140	-
75	40	BB30203547141140	-	BB30204547141140	-
90	22.5	BB30203519141140	-	BB30204519141140	-
90	25	BB30203529141140	-	BB30204529141140	-
90	30	BB30203539141140	-	BB30204539141140	-
90	40	BB30203549141140	-	BB30204549141140	-
100	22.5	BB30203511141140	-	BB30204511141140	-
100	25	BB30203521141140	-	BB30204521141140	-
100	30	BB30203531141140	-	BB30204531141140	-
100	40	BB30203541141140	-	BB30204541141140	-

60/30 CLASSIC WITH LED

SINGLE-SIDED - WITHOUT TOP SHELF AND WITH LED LIGHTING ON INTERMEDIATE SHELVES

Complete shelving system with uprights, cable channels, crossbars, steel shelves with backedge and LED lighting (see page 160 for details on LED lighting), brackets, fittings and wall securement. Cabling from bottom (cabling from above is an option, contact sales). Number of shelves are calculated for optimal shelf spacing for fiction. The LED light is placed underneath each shelf and the cable channel is placed on the left side of the bay. A starter bay is delivered with one right and one left bracket per shelf. An add-on bay is delivered with a double bracket per shelf, which places the shelves in the same height as that of the starter bay.

Height 182 cm (5 shelves and 4 LED lights)

Please contact Sales for prices on 60/30 configurations with LED.

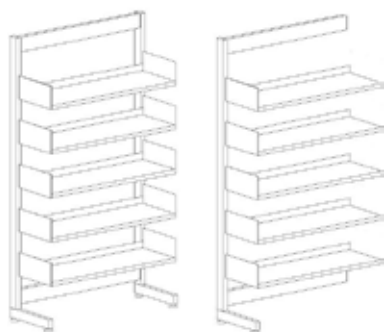

Module cm	Shelf depth cm	Item no. Starter bay	Price EUR	Item no. Add-on bay	Price EUR
75	22.5	BB30203817141150	-	BB30204817141150	-
75	25	BB30203827141150	-	BB30204827141150	-
75	30	BB30203837141150	-	BB30204837141150	-
75	40	BB30203847141150	-	BB30204847141150	-
90	22.5	BB30203819141150	-	BB30204819141150	-
90	25	BB30203829141150	-	BB30204829141150	-
90	30	BB30203839141150	-	BB30204839141150	-
90	40	BB30203849141150	-	BB30204849141150	-
100	22.5	BB30203811141150	-	BB30204811141150	-
100	25	BB30203821141150	-	BB30204821141150	-
100	30	BB30203831141150	-	BB30204831141150	-
100	40	BB30203841141150	-	BB30204841141150	-

Height 212 cm (6 shelves and 5 LED lights)

Please contact Sales for prices on 60/30 configurations with LED.

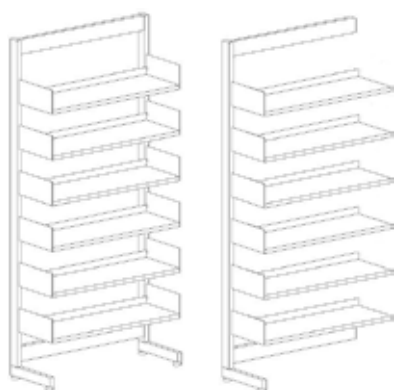

Module cm	Shelf depth cm	Item no. Starter bay	Price EUR	Item no. Add-on bay	Price EUR
75	22.5	BB30203117141160	-	BB30204117141160	-
75	25	BB30203127141160	-	BB30204127141160	-
75	30	BB30203137141160	-	BB30204137141160	-
75	40	BB30203147141160	-	BB30204147141160	-
90	22.5	BB30203119141160	-	BB30204119141160	-
90	25	BB30203129141160	-	BB30204129141160	-
90	30	BB30203139141160	-	BB30204139141160	-
90	40	BB30203149141160	-	BB30204149141160	-
100	22.5	BB30203111141160	-	BB30204111141160	-
100	25	BB30203121141160	-	BB30204121141160	-
100	30	BB30203131141160	-	BB30204131141160	-
100	40	BB30203141141160	-	BB30204141141160	-

60/30 CLASSIC WITH LED

DOUBLE-SIDED - WITHOUT TOP SHELF AND WITH LED LIGHTING ON INTERMEDIATE SHELVES

Complete shelving system with uprights, cable channels, crossbars, steel shelves with backedge and LED lighting (see page 160 for details on LED lighting), brackets and fittings. Cabling from bottom (cabling from above is an option, contact sales). Number of shelves are calculated for optimal shelf spacing for fiction. The LED light is placed underneath each shelf and the cable channel is placed on the left side of the bay. A starter bay is delivered with one right and one left bracket per shelf. An add-on bay is delivered with a double bracket per shelf, which places the shelves in the same height as that of the starter bay.

Height 92 cm (2 shelves and 1 LED light on each side)

Please contact Sales for prices on 60/30 configurations with LED.

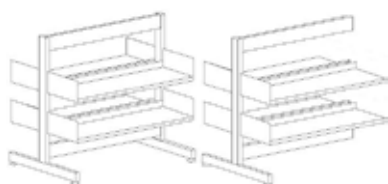

Module cm	Shelf depth cm	Item no. Starter bay	Price EUR	Item no. Add-on bay	Price EUR
75	22.5	BB30203717241120	-	BB30204717241120	-
75	25	BB30203727241120	-	BB30204727241120	-
75	30	BB30203737241120	-	BB30204737241120	-
75	40	BB30203747241120	-	BB30204747241120	-
90	22.5	BB30203719241120	-	BB30204719241120	-
90	25	BB30203729241120	-	BB30204729241120	-
90	30	BB30203739241120	-	BB30204739241120	-
90	40	BB30203749241120	-	BB30204749241120	-
100	22.5	BB30203711241120	-	BB30204711241120	-
100	25	BB30203721241120	-	BB30204721241120	-
100	30	BB30203731241120	-	BB30204731241120	-
100	40	BB30203741241120	-	BB30204741241120	-

Height 122 cm (3 shelves and 2 LED lights on each side)

Please contact Sales for prices on 60/30 configurations with LED.

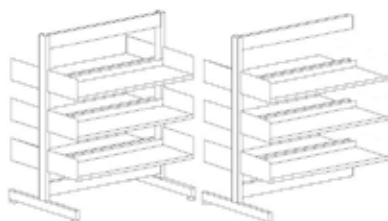

Module cm	Shelf depth cm	Item no. Starter bay	Price EUR	Item no. Add-on bay	Price EUR
75	22.5	BB30203217241130	-	BB30204217241130	-
75	25	BB30203227241130	-	BB30204227241130	-
75	30	BB30203237241130	-	BB30204237241130	-
75	40	BB30203247241130	-	BB30204247241130	-
90	22.5	BB30203219241130	-	BB30204219241130	-
90	25	BB30203229241130	-	BB30204229241130	-
90	30	BB30203239241130	-	BB30204239241130	-
90	40	BB30203249241130	-	BB30204249241130	-
100	22.5	BB30203211241130	-	BB30204211241130	-
100	25	BB30203221241130	-	BB30204221241130	-
100	30	BB30203231241130	-	BB30204231241130	-
100	40	BB30203241241130	-	BB30204241241130	-

Height 152 cm (4 shelves and 3 LED lights on each side)

Please contact Sales for prices on 60/30 configurations with LED.

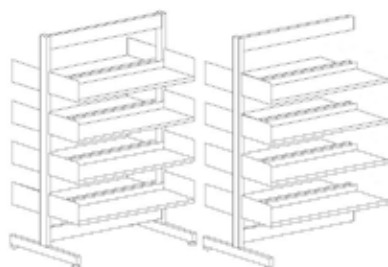

Module cm	Shelf depth cm	Item no. Starter bay	Price EUR	Item no. Add-on bay	Price EUR
75	22.5	BB30203517241140	-	BB30204517241140	-
75	25	BB30203527241140	-	BB30204527241140	-
75	30	BB30203537241140	-	BB30204537241140	-
75	40	BB30203547241140	-	BB30204547241140	-
90	22.5	BB30203519241140	-	BB30204519241140	-
90	25	BB30203529241140	-	BB30204529241140	-
90	30	BB30203539241140	-	BB30204539241140	-
90	40	BB30203549241140	-	BB30204549241140	-
100	22.5	BB30203511241140	-	BB30204511241140	-
100	25	BB30203521241140	-	BB30204521241140	-
100	30	BB30203531241140	-	BB30204531241140	-
100	40	BB30203541241140	-	BB30204541241140	-

60/30 CLASSIC WITH LED

DOUBLE-SIDED - WITHOUT TOP SHELF AND WITH LED LIGHTING ON INTERMEDIATE SHELVES

Complete shelving system with uprights, cable channels, crossbars, steel shelves with backedge and LED lighting (see page 160 for details on LED lighting), brackets and fittings. Cabling from bottom (cabling from above is an option, contact sales). Number of shelves are calculated for optimal shelf spacing for fiction. The LED light is placed underneath each shelf and the cable channel is placed on the left side of the bay. A starter bay is delivered with one right and one left bracket per shelf. An add-on bay is delivered with a double bracket per shelf, which places the shelves in the same height as that of the starter bay.

Height 182 cm (5 shelves and 4 LED lights on each side)

Please contact Sales for prices on 60/30 configurations with LED.

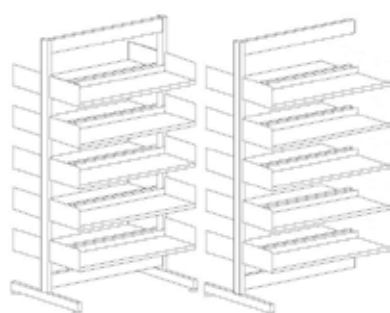

Module cm	Shelf depth cm	Item no. Starter bay	Price EUR	Item no. Add-on bay	Price EUR
75	22.5	BB30203817241150	-	BB30204817241150	-
75	25	BB30203827241150	-	BB30204827241150	-
75	30	BB30203837241150	-	BB30204837241150	-
75	40	BB30203847241150	-	BB30204847241150	-
90	22.5	BB30203819241150	-	BB30204819241150	-
90	25	BB30203829241150	-	BB30204829241150	-
90	30	BB30203839241150	-	BB30204839241150	-
90	40	BB30203849241150	-	BB30204849241150	-
100	22.5	BB30203811241150	-	BB30204811241150	-
100	25	BB30203821241150	-	BB30204821241150	-
100	30	BB30203831241150	-	BB30204831241150	-
100	40	BB30203841241150	-	BB30204841241150	-

Height 212 cm (6 shelves and 5 LED lights on each side)

Please contact Sales for prices on 60/30 configurations with LED.

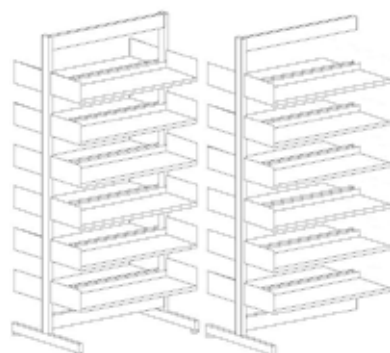

Module cm	Shelf depth cm	Item no. Starter bay	Price EUR	Item no. Add-on bay	Price EUR
75	22.5	BB30203117241160	-	BB30204117241160	-
75	25	BB30203127241160	-	BB30204127241160	-
75	30	BB30203137241160	-	BB30204137241160	-
75	40	BB30203147241160	-	BB30204147241160	-
90	22.5	BB30203119241160	-	BB30204119241160	-
90	25	BB30203129241160	-	BB30204129241160	-
90	30	BB30203139241160	-	BB30204139241160	-
90	40	BB30203149241160	-	BB30204149241160	-
100	22.5	BB30203111241160	-	BB30204111241160	-
100	25	BB30203121241160	-	BB30204121241160	-
100	30	BB30203131241160	-	BB30204131241160	-
100	40	BB30203241141160	-	BB30204241141160	-

60/30 CLASSIC WITH LED

SINGLE-SIDED - WITH TOP SHELF AND LED LIGHTING ON TOP AND INTERMEDIATE SHELVES

Complete shelving system with uprights, cable channels, crossbars, steel shelves with backedge and LED lighting, top shelves with LED lighting (see page 160 for details on LED lighting), brackets, fittings and wall securement. Cabling from bottom (cabling from above is an option, contact sales). Number of shelves are calculated for optimal shelf spacing for fiction. The LED light is placed underneath each shelf and the cable channel is placed on the left side of the bay. A starter bay is delivered with one right and one left bracket per shelf. An add-on bay is delivered with a double bracket per shelf, which places the shelves in the same height as that of the starter bay.

Height 92 cm (1 top shelf, 2 shelves and 2 LED lights)

Please contact Sales for prices on 60/30 configurations with LED.

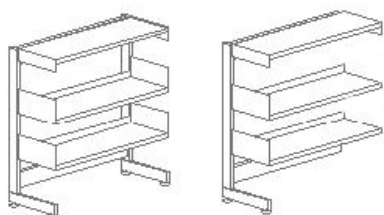

Module cm	Shelf depth cm	Item no. Starter bay	Price EUR	Item no. Add-on bay	Price EUR
75	22.5	BB30203717121121	-	BB30204717121121	-
75	25	BB30203727121121	-	BB30204727121121	-
75	30	BB30203737121121	-	BB30204737121121	-
75	40	BB30203747121121	-	BB30204747121121	-
90	22.5	BB30203719121121	-	BB30204719121121	-
90	25	BB30203729121121	-	BB30204729121121	-
90	30	BB30203739121121	-	BB30204739121121	-
90	40	BB30203749121121	-	BB30204749121121	-
100	22.5	BB30203711121121	-	BB30204711121121	-
100	25	BB30203721121121	-	BB30204721121121	-
100	30	BB30203731121121	-	BB30204731121121	-
100	40	BB30203741121121	-	BB30204741121121	-

Height 122 cm (1 top shelf, 3 shelves and 3 LED lights)

Please contact Sales for prices on 60/30 configurations with LED.

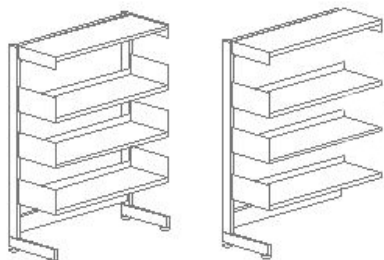

Module cm	Shelf depth cm	Item no. Starter bay	Price EUR	Item no. Add-on bay	Price EUR
75	22.5	BB30203217131131	-	BB30204217131131	-
75	25	BB30203227131131	-	BB30204227131131	-
75	30	BB30203237131131	-	BB30204237131131	-
75	40	BB30203247131131	-	BB30204247131131	-
90	22.5	BB30203219131131	-	BB30204219131131	-
90	25	BB30203229131131	-	BB30204229131131	-
90	30	BB30203239131131	-	BB30204239131131	-
90	40	BB30203249131131	-	BB30204249131131	-
100	22.5	BB30203211131131	-	BB30204211131131	-
100	25	BB30203221131131	-	BB30204221131131	-
100	30	BB30203231131131	-	BB30204231131131	-
100	40	BB30203241131131	-	BB30204241131131	-

Height 152 cm (1 top shelf, 4 shelves and 4 LED lights)

Please contact Sales for prices on 60/30 configurations with LED.

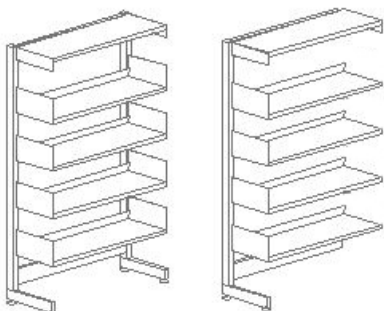

Module cm	Shelf depth cm	Item no. Starter bay	Price EUR	Item no. Add-on bay	Price EUR
75	22.5	BB30203517131141	-	BB30204517131141	-
75	25	BB30203527131141	-	BB30204527131141	-
75	30	BB30203537131141	-	BB30204537131141	-
75	40	BB30203547131141	-	BB30204547131141	-
90	22.5	BB30203519131141	-	BB30204519131141	-
90	25	BB30203529131141	-	BB30204529131141	-
90	30	BB30203539131141	-	BB30204539131141	-
90	40	BB30203549131141	-	BB30204549131141	-
100	22.5	BB30203511131141	-	BB30204511131141	-
100	25	BB30203521131141	-	BB30204521131141	-
100	30	BB30203531131141	-	BB30204531131141	-
100	40	BB30203541131141	-	BB30204541131141	-

60/30 CLASSIC WITH LED

SINGLE-SIDED - WITH TOP SHELF AND LED LIGHTING ON TOP AND INTERMEDIATE SHELVES

Complete shelving system with uprights, cable channels, crossbars, steel shelves with backedge and LED lighting, top shelves with LED lighting (see page 160 for details on LED lighting), brackets, fittings and wall securement. Cabling from bottom (cabling from above is an option, contact sales). Number of shelves are calculated for optimal shelf spacing for fiction. The LED light is placed underneath each shelf and the cable channel is placed on the left side of the bay. A starter bay is delivered with one right and one left bracket per shelf. An add-on bay is delivered with a double bracket per shelf, which places the shelves in the same height as that of the starter bay.

Height 182 cm (1 top shelf, 5 shelves and 5 LED lights)

Please contact Sales for prices on 60/30 configurations with LED.

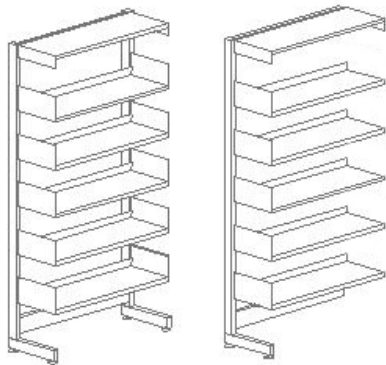

Module cm	Shelf depth cm	Item no. Starter bay	Price EUR	Item no. Add-on bay	Price EUR
75	22.5	BB30203817131151	-	BB30204817131151	-
75	25	BB30203827131151	-	BB30204827131151	-
75	30	BB30203837131151	-	BB30204837131151	-
75	40	BB30203847131151	-	BB30204847131151	-
90	22.5	BB30203819131151	-	BB30204819131151	-
90	25	BB30203829131151	-	BB30204829131151	-
90	30	BB30203839131151	-	BB30204839131151	-
90	40	BB30203849131151	-	BB30204849131151	-
100	22.5	BB30203811131151	-	BB30204811131151	-
100	25	BB30203821131151	-	BB30204821131151	-
100	30	BB30203831131151	-	BB30204831131151	-
100	40	BB30203841131151	-	BB30204841131151	-

Height 212 cm (1 top shelf, 6 shelves and 6 LED lights)

Please contact Sales for prices on 60/30 configurations with LED.

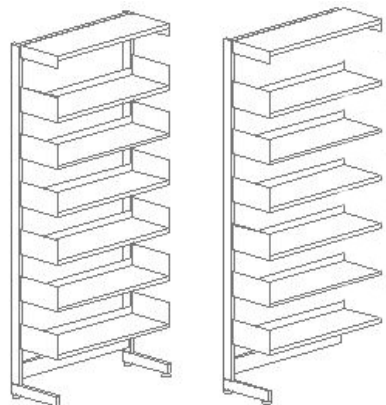

Module cm	Shelf depth cm	Item no. Starter bay	Price EUR	Item no. Add-on bay	Price EUR
75	22.5	BB30203117131161	-	BB30204117131161	-
75	25	BB30203127131161	-	BB30204127131161	-
75	30	BB30203137131161	-	BB30204137131161	-
75	40	BB30203147131161	-	BB30204147131161	-
90	22.5	BB30203119131161	-	BB30204119131161	-
90	25	BB30203129131161	-	BB30204129131161	-
90	30	BB30203139131161	-	BB30204139131161	-
90	40	BB30203149131161	-	BB30204149131161	-
100	22.5	BB30203111131161	-	BB30204111131161	-
100	25	BB30203121131161	-	BB30204121131161	-
100	30	BB30203131131161	-	BB30204131131161	-
100	40	BB30203141131161	-	BB30204141131161	-

60/30 CLASSIC WITH LED

DOUBLE-SIDED - WITH TOP SHELF AND LED LIGHTING ON TOP AND INTERMEDIATE SHELVES

Complete shelving system with uprights, cable channels, crossbars, steel shelves with backedge and LED lighting, top shelves with LED lighting (see page 160 for details on LED lighting), brackets and fittings. Cabling from bottom (cabling from above is an option, contact sales). Number of shelves are calculated for optimal shelf spacing for fiction. The LED light is placed underneath each shelf and the cable channel is placed on the left side of the bay. A starter bay is delivered with one right and one left bracket per shelf. An add-on bay is delivered with a double bracket per shelf, which places the shelves in the same height as that of the starter bay.

Height 92 cm (1 top shelf, 2 shelves and 2 LED lights on each side)

Please contact Sales for prices on 60/30 configurations with LED.

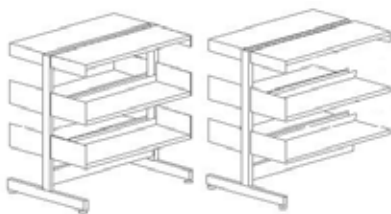

Module cm	Shelf depth cm	Item no. Starter bay	Price EUR	Item no. Add-on bay	Price EUR
75	22.5	BB30203717231121	-	BB30204717231121	-
75	25	BB30203727231121	-	BB30204727231121	-
75	30	BB30203737231121	-	BB30204737231121	-
75	40	BB30203747231121	-	BB30204747231121	-
90	22.5	BB30203719231121	-	BB30204719231121	-
90	25	BB30203729231121	-	BB30204729231121	-
90	30	BB30203739231121	-	BB30204739231121	-
90	40	BB30203749231121	-	BB30204749231121	-
100	22.5	BB30203711231121	-	BB30204711231121	-
100	25	BB30203721231121	-	BB30204721231121	-
100	30	BB30203731231121	-	BB30204731231121	-
100	40	BB30203741231121	-	BB30204741231121	-

Height 122 cm (1 top shelf, 3 shelves and 3 LED lights on each side)

Please contact Sales for prices on 60/30 configurations with LED.

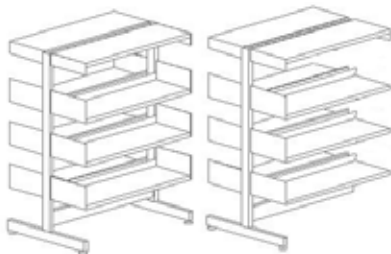

Module cm	Shelf depth cm	Item no. Starter bay	Price EUR	Item no. Add-on bay	Price EUR
75	22.5	BB30203217231131	-	BB30204217231131	-
75	25	BB30203227231131	-	BB30204227231131	-
75	30	BB30203237231131	-	BB30204237231131	-
75	40	BB30203247231131	-	BB30204247231131	-
90	22.5	BB30203219231131	-	BB30204219231131	-
90	25	BB30203229231131	-	BB30204229231131	-
90	30	BB30203239231131	-	BB30204239231131	-
90	40	BB30203249231131	-	BB30204249231131	-
100	22.5	BB30203211231131	-	BB30204211231131	-
100	25	BB30203221231131	-	BB30204221231131	-
100	30	BB30203231231131	-	BB30204231231131	-
100	40	BB30203241231131	-	BB30204241231131	-

Height 152 cm (1 top shelf, 4 shelves and 4 LED lights on each side)

Please contact Sales for prices on 60/30 configurations with LED.

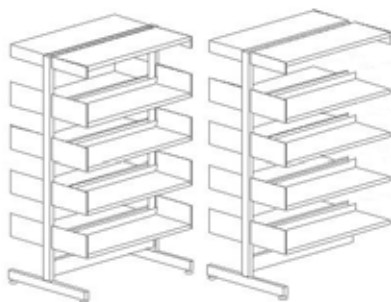

Module cm	Shelf depth cm	Item no. Starter bay	Price EUR	Item no. Add-on bay	Price EUR
75	22.5	BB30203517231141	-	BB30204517231141	-
75	25	BB30203527231141	-	BB30204527231141	-
75	30	BB30203537231141	-	BB30204537231141	-
75	40	BB30203547231141	-	BB30204547231141	-
90	22.5	BB30203519231141	-	BB30204519231141	-
90	25	BB30203529231141	-	BB30204529231141	-
90	30	BB30203539231141	-	BB30204539231141	-
90	40	BB30203549231141	-	BB30204549231141	-
100	22.5	BB30203511231141	-	BB30204511231141	-
100	25	BB30203521231141	-	BB30204521231141	-
100	30	BB30203531231141	-	BB30204531231141	-
100	40	BB30203541231141	-	BB30204541231141	-

60/30 CLASSIC WITH LED

DOUBLE-SIDED - WITH TOP SHELF AND LED LIGHTING ON TOP AND INTERMEDIATE SHELVES

Complete shelving system with uprights, cable channels, crossbars, steel shelves with backedge and LED lighting, top shelves with LED lighting (see page 160 for details on LED lighting), brackets and fittings. Cabling from bottom (cabling from above is an option, contact sales). Number of shelves are calculated for optimal shelf spacing for fiction. The LED light is placed underneath each shelf and the cable channel is placed on the left side of the bay. A starter bay is delivered with one right and one left bracket per shelf. An add-on bay is delivered with a double bracket per shelf, which places the shelves in the same height as that of the starter bay.

Height 182 cm (1 top shelf, 5 shelves and 5 LED lights on each side)

Please contact Sales for prices on 60/30 configurations with LED.

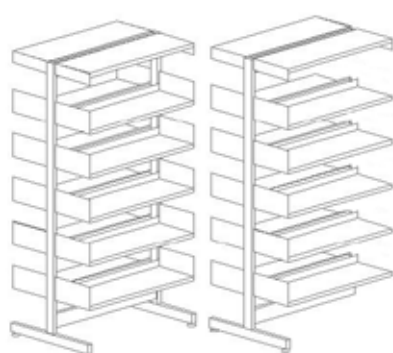

Module cm	Shelf depth cm	Item no. Starter bay	Price EUR	Item no. Add-on bay	Price EUR
75	22.5	BB30203817231151	-	BB30204817231151	-
75	25	BB30203827231151	-	BB30204827231151	-
75	30	BB30203837231151	-	BB30204837231151	-
75	40	BB30203847231151	-	BB30204847231151	-
90	22.5	BB30203819231151	-	BB30204819231151	-
90	25	BB30203829231151	-	BB30204829231151	-
90	30	BB30203839231151	-	BB30204839231151	-
90	40	BB30203849231151	-	BB30204849231151	-
100	22.5	BB30203811231151	-	BB30204811231151	-
100	25	BB30203821231151	-	BB30204821231151	-
100	30	BB30203831231151	-	BB30204831231151	-
100	40	BB30203841231151	-	BB30204841231151	-

Height 212 cm (1 top shelf, 6 shelves and 6 LED lights on each side)

Please contact Sales for prices on 60/30 configurations with LED.

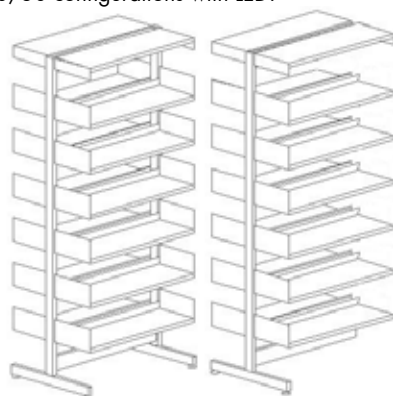

Module cm	Shelf depth cm	Item no. Starter bay	Price EUR	Item no. Add-on bay	Price EUR
75	22.5	BB30203117231161	-	BB30204117231161	-
75	25	BB30203127231161	-	BB30204127231161	-
75	30	BB30203137231161	-	BB30204137231161	-
75	40	BB30203147231161	-	BB30204147231161	-
90	22.5	BB30203119231161	-	BB30204119231161	-
90	25	BB30203129231161	-	BB30204129231161	-
90	30	BB30203139231161	-	BB30204139231161	-
90	40	BB30203149231161	-	BB30204149231161	-
100	22.5	BB30203111231161	-	BB30204111231161	-
100	25	BB30203121231161	-	BB30204121231161	-
100	30	BB30203231131161	-	BB30204231131161	-
100	40	BB30203141231161	-	BB30204141231161	-



80/30 CLASSIC STEEL SHELVING

The following pages will show basic configurations of the 60/30 Classic Steel Shelving system based on 80/30 upright installations. The wider construction of this upright allows for greater total weight and also a taller construction.



80/30 CLASSIC STEEL SHELVING

SINGLE-SIDED - WITH TOP SHELF

Complete shelving system with uprights, crossbars, shelves, top shelf, brackets, fittings and wall securement. Shelves are steel shelves with backedge, top shelf is steel shelf without backedge. Number of shelves are calculated for optimal shelf spacing for fiction. A starter bay is delivered with one right and one left bracket per shelf. An add-on bay is delivered with a double bracket per shelf, which places the shelves in the same height as that of the starter bay. Please note that standard end panels do not fit on 80/30 steel shelving and must be ordered specially, please contact customer service.

Height 199 cm (5 shelves + top shelf)

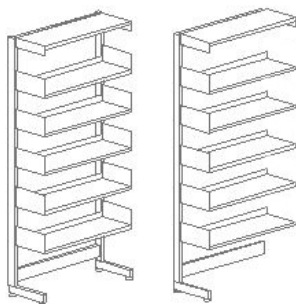

Module cm	Shelf depth cm	Item no. Starter bay	Price EUR	Item no. Add-on bay	Price EUR
75	22.5	BB304003171151	1.209,90	BB304013171151	816,00
75	25	BB304003271151	1.258,40	BB304013271151	844,70
75	30	BB304003371151	1.304,60	BB304013371151	885,70
75	40	BB304003471151	1.429,80	BB304013471151	987,80
90	22.5	BB304003191151	1.259,50	BB304013191151	859,60
90	25	BB304003291151	1.301,40	BB304013291151	881,70
90	30	BB304003391151	1.352,50	BB304013391151	927,60
90	40	BB304003491151	1.525,40	BB304013491151	1.077,40
100	22.5	BB304003111151	1.318,80	BB304013111151	912,40
100	25	BB304003211151	1.368,60	BB304013211151	942,40
100	30	BB304003311151	1.413,40	BB304013311151	982,00
100	40	BB304003411151	1.566,30	BB304013411151	1.111,80

Height 229 cm (6 shelves + top shelf)

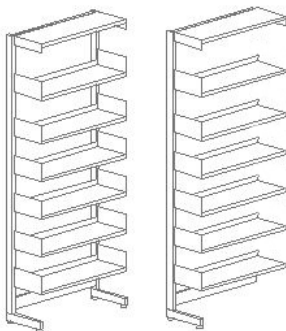

Module cm	Shelf depth cm	Item no. Starter bay	Price EUR	Item no. Add-on bay	Price EUR
75	22.5	BB304002171161	1.322,10	BB304012171161	901,40
75	25	BB304002271161	1.378,50	BB304012271161	934,80
75	30	BB304002371161	1.428,50	BB304012371161	980,30
75	40	BB304002471161	1.575,90	BB304012471161	1.100,30
90	22.5	BB304002191161	1.377,60	BB304012191161	950,90
90	25	BB304002291161	1.425,10	BB304012291161	975,40
90	30	BB304002391161	1.481,70	BB304012391161	1.027,50
90	40	BB304002491161	1.684,80	BB304012491161	1.203,20
100	22.5	BB304002111161	1.442,90	BB304012111161	1.009,70
100	25	BB304002211161	1.500,20	BB304012211161	1.044,00
100	30	BB304002311161	1.549,50	BB304012311161	1.088,80
100	40	BB304002411161	1.729,00	BB304012411161	1.240,90

Height 259 cm (7 shelves + top shelf)

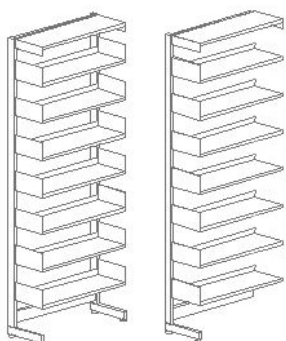

Module cm	Shelf depth cm	Item no. Starter bay	Price EUR	Item no. Add-on bay	Price EUR
75	22.5	BB304001171171	1.429,10	BB304011171171	984,20
75	25	BB304001271171	1.496,60	BB304011271171	1.023,90
75	30	BB304001371171	1.553,00	BB304011371171	1.075,20
75	40	BB304001471171	1.718,00	BB304011471171	1.210,80
90	22.5	BB304001191171	1.490,50	BB304011191171	1.039,60
90	25	BB304001291171	1.546,80	BB304011291171	1.068,10
90	30	BB304001391171	1.611,50	BB304011391171	1.127,70
90	40	BB304001491171	1.840,20	BB304011491171	1.327,00
100	22.5	BB304001111171	1.561,80	BB304011111171	1.104,40
100	25	BB304001211171	1.629,80	BB304011211171	1.144,60
100	30	BB304001311171	1.686,20	BB304011311171	1.195,90
100	40	BB304001411171	1.887,70	BB304011411171	1.368,00

80/30 CLASSIC STEEL SHELVING

DOUBLE-SIDED - WITH TOP SHELF

Complete shelving system with uprights, crossbars, shelves, top shelf, brackets and fittings. Shelves are steel shelves with backedge, top shelf is steel shelf without backedge. Number of shelves are calculated for optimal shelf spacing for fiction. A starter bay is delivered with one right and one left bracket per shelf. An add-on bay is delivered with a double bracket per shelf, which places the shelves in the same height as that of the starter bay. Please note that standard end panels do not fit on 80/30 steel shelving and must be ordered specially, please contact customer service.

Height 199 cm (5 shelves + top shelf on each side)

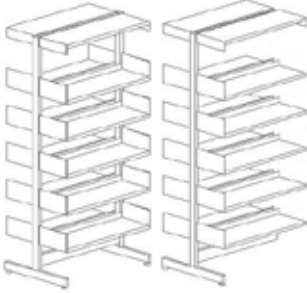
	Module cm	Shelf depth cm	Item no.		Price	
			Starter bay	Price EUR	Add-on bay	Price EUR
	75	22.5	BB304003172151	1.775,40	BB304013172151	1.275,70
	75	25	BB304003272151	1.891,80	BB304013272151	1.342,80
	75	30	BB304003372151	1.953,40	BB304013372151	1.409,40
	75	40	BB304003472151	2.223,20	BB304013472151	1.623,30
	90	22.5	BB304003192151	1.856,60	BB304013192151	1.350,90
	90	25	BB304003292151	1.959,80	BB304013292151	1.404,80
	90	30	BB304003392151	2.031,20	BB304013392151	1.481,20
	90	40	BB304003492151	2.396,40	BB304013492151	1.790,50
	100	22.5	BB304003112151	1.955,70	BB304013112151	1.443,50
	100	25	BB304003212151	2.074,70	BB304013212151	1.513,20
	100	30	BB304003312151	2.133,50	BB304013312151	1.577,00
	100	40	BB304003412151	2.458,70	BB304013412151	1.846,30

Height 229 cm (6 shelves + top shelf on each side)

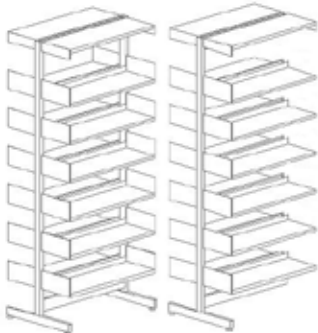
	Module cm	Shelf depth cm	Item no.		Price	
			Starter bay	Price EUR	Add-on bay	Price EUR
	75	22.5	BB304002172161	1.973,00	BB304012172161	1.433,10
	75	25	BB304002272161	2.076,00	BB304012272161	1.495,00
	75	30	BB304002372161	2.171,60	BB304012372161	1.583,80
	75	40	BB304002472161	2.484,60	BB304012472161	1.832,90
	90	22.5	BB304002192161	2.066,00	BB304012192161	1.520,10
	90	25	BB304002292161	2.151,20	BB304012292161	1.564,20
	90	30	BB304002392161	2.260,00	BB304012392161	1.666,20
	90	40	BB304002492161	2.684,40	BB304012492161	2.026,70
	100	22.5	BB304002112161	2.177,10	BB304012112161	1.624,70
	100	25	BB304002212161	2.281,90	BB304012212161	1.688,40
	100	30	BB304002312161	2.376,10	BB304012312161	1.775,80
	100	40	BB304002412161	2.753,30	BB304012412161	2.089,10

Height 259 cm (7 shelves + top shelf on each side)

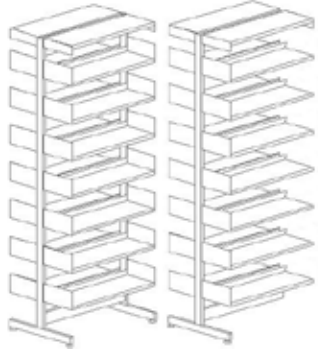
	Module cm	Shelf depth cm	Item no.		Price	
			Starter bay	Price EUR	Add-on bay	Price EUR
	75	22.5	BB304001172171	2.166,60	BB304011172171	1.588,50
	75	25	BB304001272171	2.290,40	BB304011272171	1.662,30
	75	30	BB304001372171	2.395,40	BB304011372171	1.761,00
	75	40	BB304001472171	2.747,00	BB304011472171	2.043,00
	90	22.5	BB304001192171	2.271,40	BB304011192171	1.687,30
	90	25	BB304001292171	2.372,80	BB304011292171	1.738,70
	90	30	BB304001392171	2.494,40	BB304011392171	1.854,00
	90	40	BB304001492171	2.973,40	BB304011492171	2.263,40
	100	22.5	BB304001112171	2.394,50	BB304011112171	1.803,90
	100	25	BB304001212171	2.519,30	BB304011212171	1.878,70
	100	30	BB304001312171	2.624,30	BB304011312171	1.977,40
	100	40	BB304001412171	3.048,90	BB304011412171	2.332,40



60/30 CLASSIC STEEL SHELVING - WALL

The following pages will show basic configurations of the 60/30 Classic Steel Shelving system based on 60/30 Classic wall strip installations.



CLASSIC STEEL SHELVING - WALL

WITH TOP SHELF

Complete shelving system with wall strips, shelves, top shelf, brackets and fittings. Shelves are steel shelves with backedge, top shelf is steel shelf without backedge. Number of shelves are calculated for optimal shelf spacing for fiction. A starter bay is delivered with one right and one left bracket per shelf. An add-on bay is delivered with a double bracket per shelf, which places the shelves in the same height as that of the starter bay. Please note that standard end panels do not fit on 60/30 wall steel shelving and must be ordered specially, please contact customer service.

Height 112.5 cm (3 shelves + top shelf)

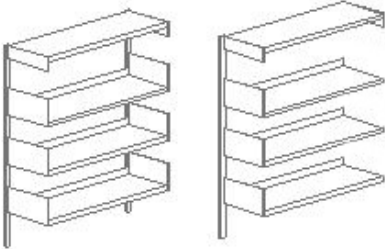
	Module cm	Shelf depth cm	Item no. Starter bay	Price EUR	Item no. Add-on bay	Price EUR
	75	22.5	BB302001117131	401,90	BB302011117131	319,30
	75	25	BB302001127131	426,60	BB302011127131	334,60
	75	30	BB302001137131	451,20	BB302011137131	359,60
	75	40	BB302001147131	525,80	BB302011147131	422,80
	90	22.5	BB302001119131	421,70	BB302011119131	339,10
	90	25	BB302001129131	444,40	BB302011129131	352,40
	90	30	BB302001139131	470,50	BB302011139131	378,90
	90	40	BB302001149131	576,80	BB302011149131	473,80
	100	22.5	BB302001111131	449,50	BB302011111131	366,90
	100	25	BB302001121131	476,30	BB302011121131	384,30
	100	30	BB302001131131	498,10	BB302011131131	406,50
	100	40	BB302001141131	591,60	BB302011141131	488,60

Height 142.5 cm (4 shelves + top shelf)

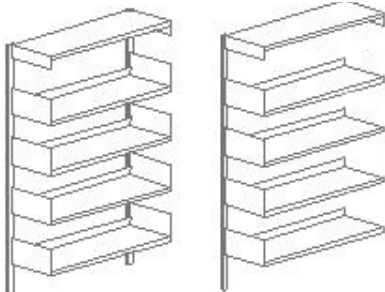
	Module cm	Shelf depth cm	Item no. Starter bay	Price EUR	Item no. Add-on bay	Price EUR
	75	22.5	BB302001417141	502,70	BB302011417141	399,00
	75	25	BB302001427141	535,10	BB302011427141	418,90
	75	30	BB302001437141	564,70	BB302011437141	449,00
	75	40	BB302001447141	659,50	BB302011447141	529,10
	90	22.5	BB302001419141	528,40	BB302011419141	424,70
	90	25	BB302001429141	556,50	BB302011429141	440,30
	90	30	BB302001439141	589,30	BB302011439141	473,60
	90	40	BB302001449141	723,80	BB302011449141	593,40
	100	22.5	BB302001411141	562,20	BB302011411141	458,50
	100	25	BB302001421141	596,30	BB302011421141	480,10
	100	30	BB302001431141	623,80	BB302011431141	508,10
	100	40	BB302001441141	741,90	BB302011441141	611,50

CLASSIC STEEL SHELVING - WALL

WITH TOP SHELF

Complete shelving system with wall strips, shelves, top shelf, brackets and fittings. Shelves are steel shelves with backedge, top shelf is steel shelf without backedge. Number of shelves are calculated for optimal shelf spacing for fiction. A starter bay is delivered with one right and one left bracket per shelf. An add-on bay is delivered with a double bracket per shelf, which places the shelves in the same height as that of the starter bay. Please note that standard end panels do not fit on 60/30 wall steel shelving and must be ordered specially, please contact customer service.

Height 172.5 cm (5 shelves + top shelf)

	Module cm	Shelf depth cm	Item no. Starter bay	Price EUR	Item no. Add-on bay	Price EUR
	75	22.5	BB302001717151	597,50	BB302011717151	475,70
	75	25	BB302001727151	637,60	BB302011727151	500,20
	75	30	BB302001737151	672,20	BB302011737151	535,40
	75	40	BB302001747151	787,20	BB302011747151	632,40
	90	22.5	BB302001719151	629,10	BB302011719151	507,30
	90	25	BB302001729151	662,60	BB302011729151	525,20
	90	30	BB302001739151	702,10	BB302011739151	565,30
	90	40	BB302001749151	864,80	BB302011749151	710,00
	100	22.5	BB302001711151	668,90	BB302011711151	547,10
	100	25	BB302001721151	710,30	BB302011721151	572,90
	100	30	BB302001731151	743,50	BB302011731151	606,70
	100	40	BB302001741151	886,20	BB302011741151	731,40

Height 202.5 cm (6 shelves + top shelf)

	Module cm	Shelf depth cm	Item no. Starter bay	Price EUR	Item no. Add-on bay	Price EUR
	75	22.5	BB302002017161	693,30	BB302012017161	552,90
	75	25	BB302002027161	741,10	BB302012027161	582,00
	75	30	BB302002037161	780,70	BB302012037161	622,30
	75	40	BB302002047161	915,90	BB302012047161	736,20
	90	22.5	BB302002019161	730,80	BB302012019161	590,40
	90	25	BB302002029161	769,70	BB302012029161	610,60
	90	30	BB302002039161	815,90	BB302012039161	657,50
	90	40	BB302002049161	1.006,80	BB302012049161	827,10
	100	22.5	BB302002011161	776,60	BB302012011161	636,20
	100	25	BB302002021161	825,30	BB302012021161	666,20
	100	30	BB302002031161	864,20	BB302012031161	705,80
	100	40	BB302002041161	1.031,50	BB302012041161	851,80

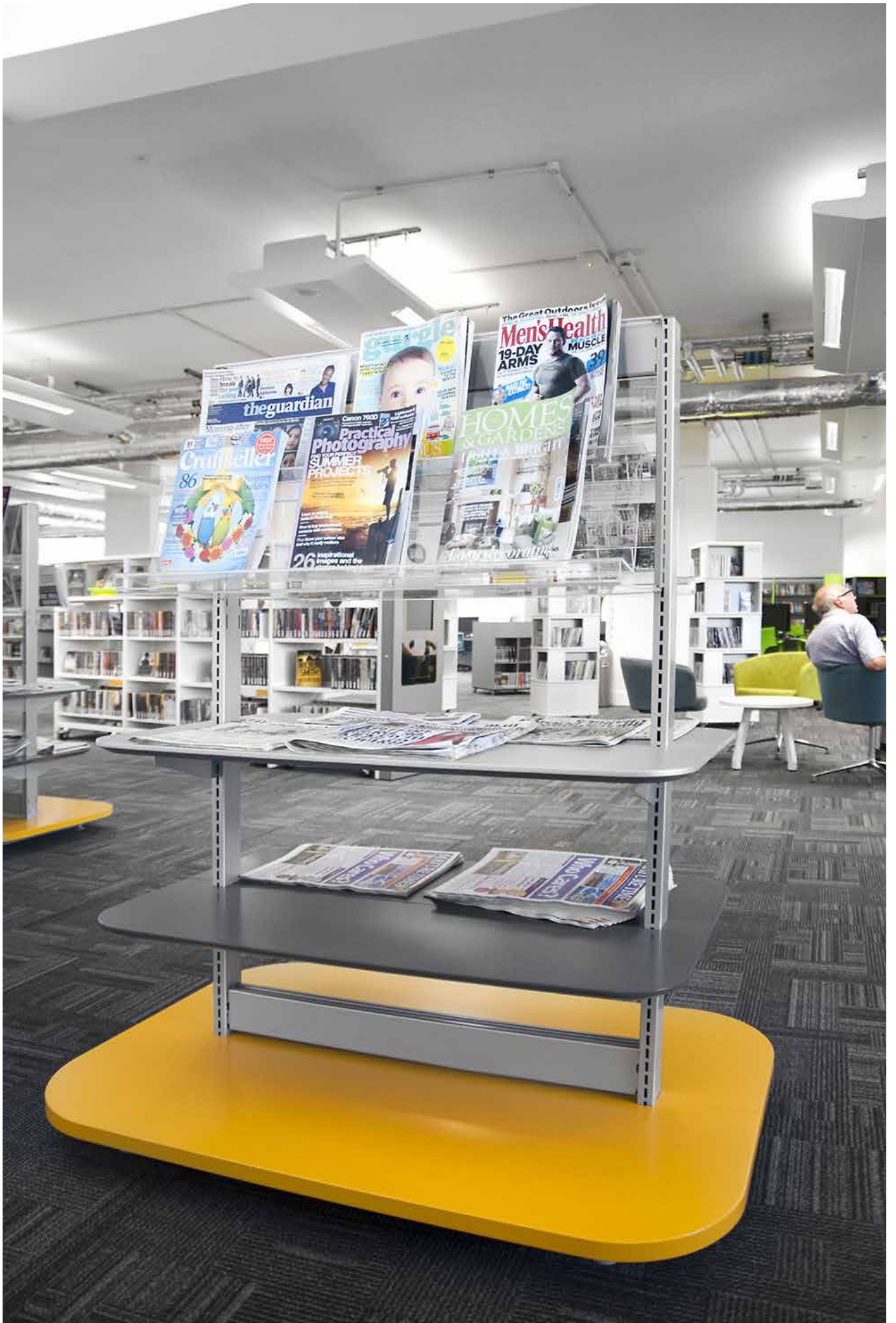

On the following pages you will find a selection of 60/30 Expo configurations including prices and lists of components included in the specific configuration. Please note that other configurations are available.

60/30 Expo is available as double-sided over a maximum of 3 bays. It consists of components, which are used for the 60/30 Classic shelving configurations along with a series of specific 60/30 Expo components. 60/30 Expo is made of steel uprights, painted wooden shelves and acrylic display shelves. The steel uprights and painted wooden shelves are available in all our standard colours. Note that wooden shelves cannot be placed next to an acrylic shelf and wooden shelves cannot be placed in front of back panels.

Acrylic display shelf

Shelf depth cm	Item no.	Price EUR
30	B30850039	318,27

Bracket for shelf

Shelf depth cm	Item no. Starter bay	Price EUR
30	B3085043	6,52

Double-sided bottom shelf with round corners



No. of bays	Item no. Painted	Price EUR
1	B308505392155	601,43
2	B308505392255	958,66
3	B308505392355	1.303,93

Double-sided shelf with round corners



No. of bays	Item no. Painted	Price EUR
1	B308508392155	465,63
2	B308508392255	673,51
3	B308508392355	996,04

Double-sided shelf for back panel with round corners



No. of bays	Item no. Painted	Price EUR
1	B308511392145	378,39
2	B308511392245	540,78

Castors

H9.9 cm.

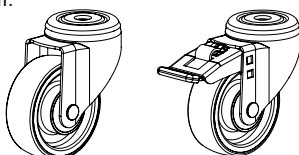

Brakes	Item no.	Price EUR
Without	B3060000	51,87
With	B3060001	72,22

60/30 EXPO

DOUBLE-SIDED - H122 CM - 1 BAY

Height 122 cm - 1 bay

Module 90 cm / depth 30 cm

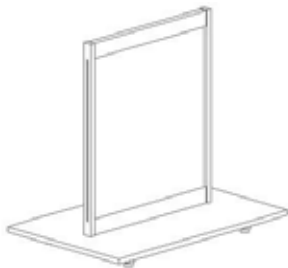

The configurations consist of the following components:

Component	Round corners Item no.	Quantity
Upright	B301000232	2
Crossbar	B3010129	2
Back panel	B301900295	1
Bottom shelf	B30850539215	1

Round corners Configuration	Price EUR
Expo 34	1.270,68

Height 122 cm - 1 bay

Module 90 cm / depth 30 cm

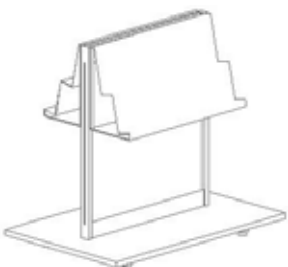

The configurations consist of the following components:

Component	Round corners Item no.	Quantity
Upright	B301000232	2
Crossbar	B3010129	2
Back panel	B301900295	1
Bottom shelf	B30850539215	1
Acrylic display shelf	B30850039	2

Round corners Configuration	Price EUR
Expo 35	1.907,22

Height 122 cm - 1 bay

Module 90 cm / depth 30 cm

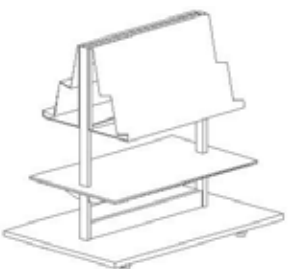

The configurations consist of the following components:

Component	Round corners Item no.	Quantity
Upright	B301000232	2
Crossbar	B3010129	2
Bottom shelf	B30850539215	1
Acrylic display shelf	B30850039	2
Shelf	B30850839215	1
Bracket for shelf	B3085043	4

Round corners Configuration	Price EUR
Expo 36	2.195,44

Height 122 cm - 1 bay

Module 90 cm / depth 30 cm



The configurations consist of the following components:

Component	Round corners Item no.	Quantity
Upright	B301000232	2
Crossbar	B3010129	2
Bottom shelf	B30850539215	1
Shelf	B30850839215	3
Bracket for shelf	B3085043	12

Round corners Configuration	Price EUR
Expo 37	2.542,32

60/30 EXPO

DOUBLE-SIDED - H122 CM - 2 BAYS

Height 122 cm - 2 bays

Module 90 cm / depth 30 cm

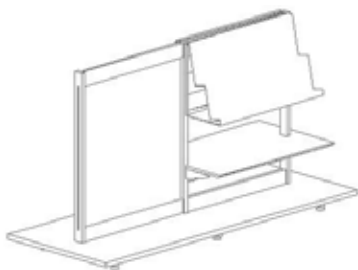

The configurations consist of the following components:

Component	Round corners Item no.	Quantity
Upright	B301000232	3
Crossbar	B3010129	4
Back panel	B301900295	1
Bottom shelf	B30850539225	1
Acrylic display shelf	B30850039	2
Shelf	B30851139214	1
Bracket for shelf	B3085043	4

Round corners Configuration	Price EUR
Expo 38	2.968,03

Height 122 cm - 2 bays

Module 90 cm / depth 30 cm

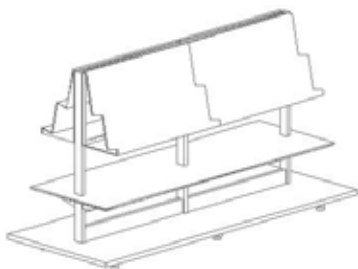

The configurations consist of the following components:

Component	Round corners Item no.	Quantity
Upright	B301000232	3
Crossbar	B3010129	4
Bottom shelf	B30850539225	1
Acrylic display shelf	B30850039	4
Shelf	B30850839225	1
Bracket for shelf	B3085043	6

Round corners Configuration	Price EUR
Expo 39	3.709,24

Height 122 cm - 2 bays

Module 90 cm / depth 30 cm

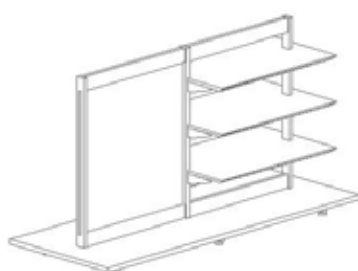

The configurations consist of the following components:

Component	Round corners Item no.	Quantity
Upright	B301000232	3
Crossbar	B3010129	4
Back panel	B301900295	1
Bottom shelf	B30850539225	1
Shelf	B30851139214	3
Bracket for shelf	B3085043	12

Round corners Configuration	Price EUR
Expo 40	3.140,43

Height 122 cm - 2 bays

Module 90 cm / depth 30 cm

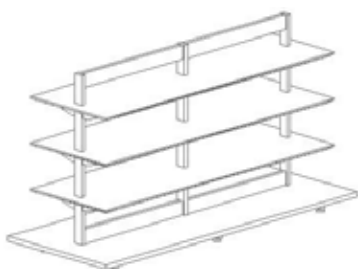

The configurations consist of the following components:

Component	Round corners Item no.	Quantity
Upright	B301000232	3
Crossbar	B3010129	4
Bottom shelf	B30850539225	1
Shelf	B30850839225	3
Bracket for shelf	B3085043	18

Round corners Configuration	Price EUR
Expo 41	3.861,42

60/30 EXPO

DOUBLE-SIDED - H122 CM - 3 BAYS

Height 122 cm - 3 bays

Module 90 cm / depth 30 cm

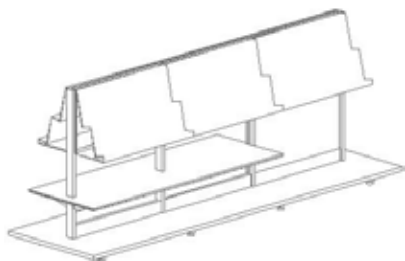

The configurations consist of the following components:

Component

Upright
Crossbar
Back panel
Bottom shelf
Acrylic display shelf
Shelf
Bracket for shelf

Round corners
Configuration

Expo 42

Price
EUR

5.060,92

Round corners
Item no.

Quantity

B301000232
B3010129
B301900295
B30850539235
B30850039
B30851139224
B3085043

4
6
1
1
6
1
6

Height 122 cm - 3 bays

Module 90 cm / depth 30 cm

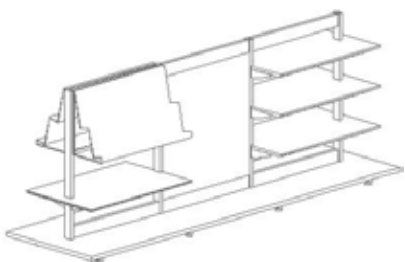

The configurations consist of the following components:

Component

Upright
Crossbar
Back panel
Bottom shelf
Acrylic display shelf
Shelf
Bracket for shelf

Round corners
Configuration

Expo 43

Price
EUR

5.475,38

Round corners
Item no.

Quantity

B301000232
B3010129
B301900295
B30850539235
B30850039
B30851139224
B3085043

4
6
1
1
2
4
16

Height 122 cm - 3 bays

Module 90 cm / depth 30 cm

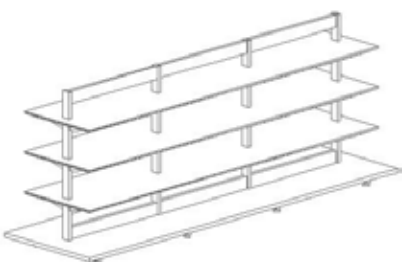

The configurations consist of the following components:

Component

Upright
Crossbar
Bottom shelf
Shelf
Bracket for shelf

Round corners
Configuration

Expo 44

Price
EUR

5.512,51

Round corners
Item no.

Quantity

B301000232
B3010129
B30850539235
B30850839235
B3085043

4
6
1
3
24

60/30 EXPO

DOUBLE-SIDED - H152 CM - 1 BAY

Height 152 cm - 1 bay

Module 90 cm / depth 30 cm



The configurations consist of the following components:

Component	Round corners Item no.	Quantity
Upright	B301000532	2
Crossbar	B3010129	2
Back panel	B301900595	1
Bottom shelf	B30850539215	1

Round corners Configuration	Price EUR
Expo 81	1.367,36

Height 152 cm - 1 bay

Module 90 cm / depth 30 cm

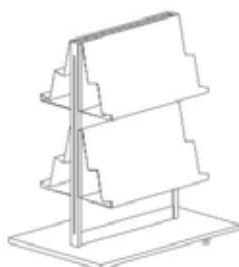

The configurations consist of the following components:

Component	Round corners Item no.	Quantity
Upright	B301000532	2
Crossbar	B3010129	2
Back panel	B301900595	1
Bottom shelf	B30850539215	1
Acrylic display shelf	B30850039	4

Round corners Configuration	Price EUR
Expo 82	2.640,44

Height 152 cm - 1 bay

Module 90 cm / depth 30 cm

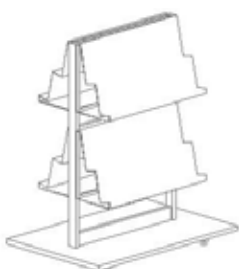

The configurations consist of the following components:

Component	Round corners Item no.	Quantity
Upright	B301000532	2
Crossbar	B3010129	2
Bottom shelf	B30850539215	1
Acrylic display shelf	B30850039	4

Round corners Configuration	Price EUR
Expo 83	2.371,65

Height 152 cm - 1 bay

Module 90 cm / depth 30 cm



The configurations consist of the following components:

Component	Round corners Item no.	Quantity
Upright	B301000532	2
Crossbar	B3010129	2
Bottom shelf	B30850539215	1
Acrylic display shelf	B30850039	2
Shelf	B30850839215	2
Bracket for shelf	B3085043	8

Round corners Configuration	Price EUR
Expo 84	2.718,53

60/30 EXPO

DOUBLE-SIDED - H152 CM - 1 & 2 BAYS

Height 152 cm - 1 bay

Module 90 cm / depth 30 cm



The configurations consist of the following components:

Component	Round corners Item no.	Quantity
Upright	B301000532	2
Crossbar	B3010129	2
Bottom shelf	B30850539215	1
Shelf	B30850839215	4
Bracket for shelf	B3085043	16

Round corners Configuration

Price EUR

Expo 85

3.065,41

Height 152 cm - 2 bays

Module 90 cm / depth 30 cm

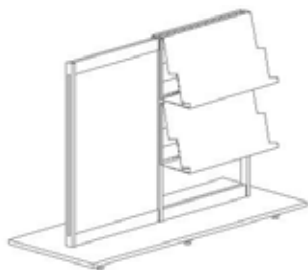

The configurations consist of the following components:

Component	Round corners Item no.	Quantity
Upright	B301000532	3
Crossbar	B3010129	4
Back panel	B301900595	1
Bottom shelf	B30850539225	1
Acrylic display shelf	B30850039	4

Round corners Configuration

Price EUR

Expo 86

3.312,47

Height 152 cm - 2 bays

Module 90 cm / depth 30 cm



The configurations consist of the following components:

Component	Round corners Item no.	Quantity
Upright	B301000532	3
Crossbar	B3010129	4
Bottom shelf	B30850539225	1
Acrylic display shelf	B30850039	2
Shelf	B30851139214	2
Bracket for shelf	B3085043	8

Round corners Configuration

Price EUR

Expo 87

3.216,08

Height 152 cm - 2 bays

Module 90 cm / depth 30 cm

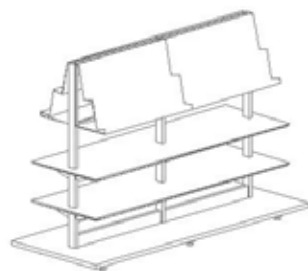

The configurations consist of the following components:

Component	Round corners Item no.	Quantity
Upright	B301000532	3
Crossbar	B3010129	4
Bottom shelf	B30850539225	1
Acrylic display shelf	B30850039	4
Shelf	B30850839225	2
Bracket for shelf	B3085043	12

Round corners Configuration

Price EUR

Expo 88

4.468,94

60/30 EXPO

DOUBLE-SIDED - H152 CM - 2 & 3 BAYS

Height 152 cm - 2 bays

Module 90 cm / depth 30 cm

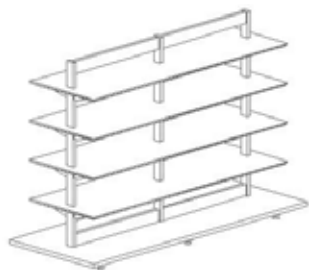

The configurations consist of the following components:

Component	Round corners Item no.	Quantity
Upright	B301000532	3
Crossbar	B3010129	4
Bottom shelf	B30850539225	1
Shelf	B30850839225	4
Bracket for shelf	B3085043	24

Round corners Configuration	Price EUR
Expo 89	4.621,12

Height 152 cm - 3 bays

Module 90 cm / depth 30 cm

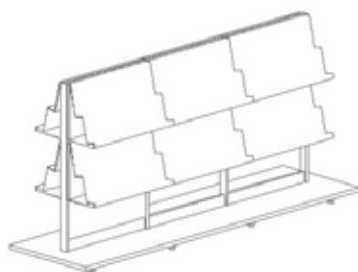

The configurations consist of the following components:

Component	Round corners Item no.	Quantity
Upright	B301000532	4
Crossbar	B3010129	6
Back panel	B301900595	1
Bottom shelf	B30850539235	1
Acrylic display shelf	B30850039	12

Round corners Configuration	Price EUR
Expo 90	6.518,70

Height 152 cm - 3 bays

Module 90 cm / depth 30 cm

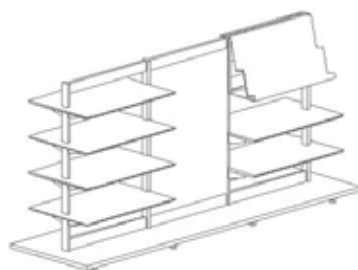

The configurations consist of the following components:

Component	Round corners Item no.	Quantity
Upright	B301000532	4
Crossbar	B3010129	6
Back panel	B301900595	1
Bottom shelf	B30850539235	1
Acrylic display shelf	B30850039	2
Shelf	B30851139214	6
Bracket for shelf	B3085043	24

Round corners Configuration	Price EUR
Expo 91	5.762,82

Height 152 cm - 3 bays

Module 90 cm / depth 30 cm

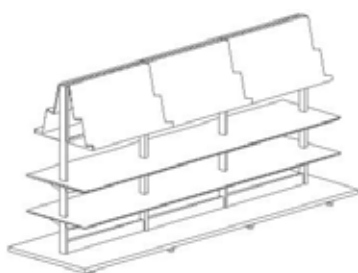

The configurations consist of the following components:

Component	Round corners Item no.	Quantity
Upright	B301000532	4
Crossbar	B3010129	6
Bottom shelf	B30850539235	1
Acrylic display shelf	B30850039	6
Shelf	B30850839235	2
Bracket for shelf	B3085043	16

Round corners Configuration	Price EUR
Expo 92	6.436,69

SHELVES

S1 & S2 STEEL SHELVES

See below for overview of standard steel shelves:

B401001 - S1 STEEL SHELF WITH STEEL BACKEDGE - FOR BACKEDGE BOOK SUPPORT

Details:

- Module 750/900/1000 mm
- Depth 225/250/300/400 mm
- Steel backedge H47 mm
- Backedge book support
- Steel plate brackets
- Max. weight 80 kg.
- Straight, 45°/60° sloping & 7,5° reverse tilted
- Use with steel top shelf B401003, B401011, B301049, B301049 and wooden top shelf B401020

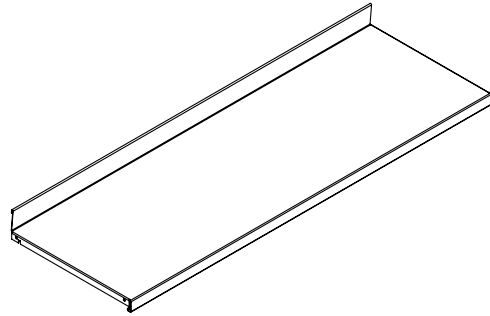

B401013 - S2 STEEL SHELF WITH ACRYLIC BACKEDGE - FOR HANGING BOOK SUPPORT

Details:

- Module 750/900/1000 mm
- Depth 225/250/300/400 mm
- Acrylic backedge H17 mm (loose part)
- Hanging book support
- Steel plate brackets
- Max. weight 80 kg.
- Straight, 45°/60° sloping & 7,5° reverse tilted
- Use with steel top shelf B401005

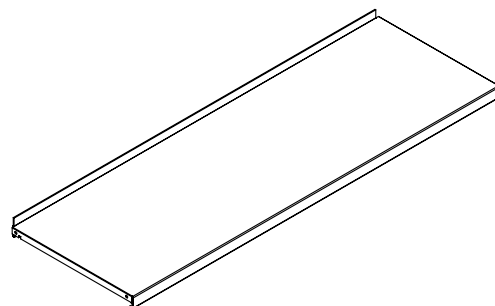

See below for overview of standard steel bottom shelves:

B301410 - BOTTOM STEEL SHELF WITH PLINTH

Details:

- Module 750/900/1000 mm
- Depth 225/250/300/400 mm
- Steel backedge H47 mm
- Steel brackets
- Max. weight 80 kg.
- Use with steel shelf B401001, steel top shelf B401003, B401011, B301049, B301049, and wooden top shelf B401020

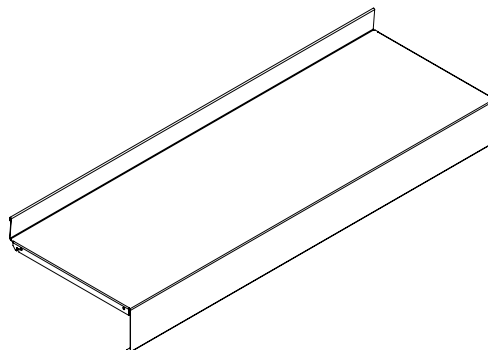

SHELVES

S1 STEEL SHELF WITH STEEL BACKEDGE

S1 steel shelf with steel backedge and steel brackets - for backedge book support

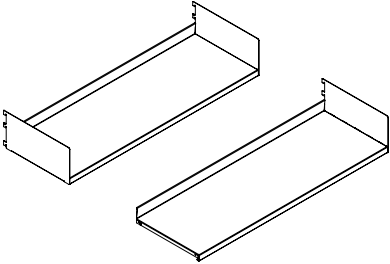
Steel backedge H47 mm. Incl. H15 cm brackets. Shelves for starter bays include left and right brackets. Shelves for add-on bays include double bracket.	Module cm	Shelf depth cm	Item no. Starter bay	Price EUR	Item no. Add-on bay	Price EUR
	75	22.5	BB4007621117	75,42	BB4007622117	63,84
	75	25	BB4007621127	82,32	BB4007622127	67,96
	75	30	BB4007621137	86,73	BB4007622137	72,49
	75	40	BB4007621147	104,67	BB4007622147	87,65
	90	22.5	BB4007621119	80,74	BB4007622119	69,16
	90	25	BB4007621129	85,51	BB4007622129	71,15
	90	30	BB4007621139	91,51	BB4007622139	77,27
	90	40	BB4007621149	116,51	BB4007622149	99,49
	100	22.5	BB4007621111	86,06	BB4007622111	74,48
	100	25	BB4007621121	92,56	BB4007622121	78,20
	100	30	BB4007621131	97,63	BB4007622131	83,39
	100	40	BB4007621141	119,43	BB4007622141	102,41

S1 steel shelf with steel frontedge and 45°/60° steel plate brackets

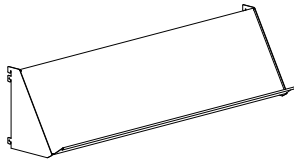
Steel backedge H47 mm. Incl. left and right brackets.	Module cm	Shelf depth cm	Item no. 45°	Price EUR	Item no. 60°	Price EUR
	75	22.5	BB301201745	124,36	BB301201760	124,36
	75	25	BB301202745	128,08	BB301202760	128,08
	75	30	BB301203745	131,41	BB301203760	131,41
	90	22.5	BB301201945	129,68	BB301201960	129,68
	90	25	BB301202945	131,27	BB301202960	131,27
	90	30	BB301203945	136,19	BB301203960	136,19
	100	22.5	BB301201145	135,00	BB301201160	135,00
	100	25	BB301202145	138,32	BB301202160	138,32
	100	30	BB301203145	142,31	BB301203160	142,31

S1 steel shelf with steel backedge and 7.5° reverse tilted steel plate brackets

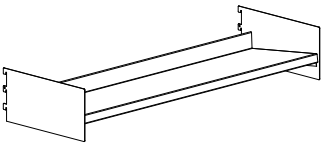
Steel backedge H47 mm. Incl. left and right brackets.	Module cm	Shelf depth cm	Dimension W X H cm	Item no.	Price EUR
	75	22.5	25 x 15	BB30122174	109,46
	75	22.5	30 x 15	BB30122171	109,46
	75	25	30 x 15	BB30122275	113,18
	75	30	35 x 20	BB30122372	131,41
	75	30	40 x 15	BB30122376	131,41
	75	30	40 x 20	BB30122373	131,41
	90	22.5	25 x 15	BB30122194	114,78
	90	22.5	30 x 15	BB30122191	114,78
	90	25	30 x 15	BB30122295	116,37
	90	30	35 x 20	BB30122392	136,19
	90	30	40 x 15	BB30122396	136,19
	90	30	40 x 20	BB30122393	136,19
	100	22.5	25 x 15	BB30122114	120,10
	100	22.5	30 x 15	BB30122111	120,10
	100	25	30 x 15	BB30122215	123,42
	100	30	35 x 20	BB30122312	142,31
	100	30	40 x 15	BB30122316	142,31
	100	30	40 x 20	BB30122313	142,31

SHELVES

S1 STEEL SHELF WITH STEEL BACKEDGE

S1 steel shelf with steel backedge - for backedge book support

Steel backedge H47 mm. Left, right or double brackets must be ordered separately. See page 72.

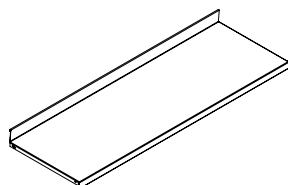

Module cm	Shelf depth cm	Item no.	Price EUR
75	22.5	B40100117	49,08
75	25	B40100127	52,80
75	30	B40100137	56,13
75	40	B40100147	67,43
90	22.5	B40100119	54,40
90	25	B40100129	55,99
90	30	B40100139	60,91
90	40	B40100149	79,27
100	22.5	B40100111	59,72
100	25	B40100121	63,04
100	30	B40100131	67,03
100	40	B40100141	82,19

Backedge book support - for S1 steel shelf

Nickel plated steel, Ø6 mm, with a nylon glider.

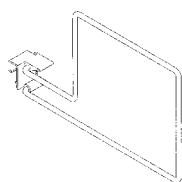

Height cm	Shelf depth cm	Type	Item no.	Price EUR
16,3	22.5/25	For books on left side of book support	B4011221	16,89
16,3	30	For books on left side of book support	B4011222	18,22
24,3	25/30	For books on left side of book support	B4011223	23,67
16,3	22.5/25	For books on right side of book support	B4011224	16,89
16,3	30	For books on right side of book support	B4011225	18,22

SHELVES

S2 STEEL SHELF WITH ACRYLIC BACKEDGE

S2 steel shelf with acrylic backedge and steel brackets - for hanging book support

Acrylic backedge H17 mm. Shelves for starter bays include left and right brackets. Shelves for add-on bays include double bracket. Note: Spot welding visible on top of surface.

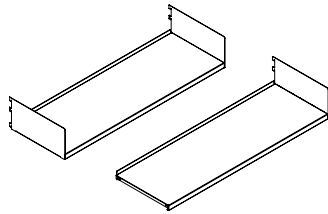

Module cm	Shelf depth cm	Item no. Starter bay	Price EUR	Item no. Add-on bay	Price EUR
75	22.5	BB4007721117	65,04	BB4007722117	53,46
75	25	BB4007721127	68,22	BB4007722127	53,86
75	30	BB4007721137	73,96	BB4007722137	59,72
75	40	BB4007721147	109,86	BB4007722147	92,84
90	22.5	BB4007721119	65,04	BB4007722119	53,46
90	25	BB4007721129	68,22	BB4007722129	53,86
90	30	BB4007721139	73,96	BB4007722139	59,72
90	40	BB4007721149	109,86	BB4007722149	92,84
100	22.5	BB4007721111	69,30	BB4007722111	57,72
100	25	BB4007721121	72,48	BB4007722121	58,12
100	30	BB4007721131	79,54	BB4007722131	65,30
100	40	BB4007721141	118,64	BB4007722141	101,62

S2 steel shelf with acrylic backedge and 45°/60° steel plate brackets

Acrylic backedge H17 mm. Incl. left and right brackets. Note: Spot welding visible on top of surface.

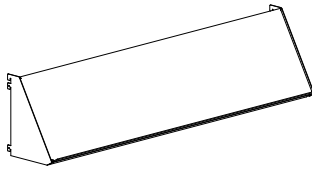

Module cm	Shelf depth cm	Item no. 45°	Price EUR	Item no. 60°	Price EUR
75	22.5	BB301241745	113,98	BB301241760	113,98
75	25	BB301242745	113,98	BB301242760	113,98
75	30	BB301243745	118,64	BB301243760	118,64
90	22.5	BB301241945	113,98	BB301241960	113,98
90	25	BB301242945	113,98	BB301242960	113,98
90	30	BB301243945	118,64	BB301243960	118,64
100	22.5	BB301241145	118,24	BB301241160	118,24
100	25	BB301242145	118,24	BB301242160	118,24
100	30	BB301243145	124,22	BB301243160	124,22

S2 steel shelf with acrylic backedge and 7.5° reverse tilted steel plate brackets

Acrylic backedge H17 mm. Incl. left and right brackets. Note: Spot welding visible on top of surface.

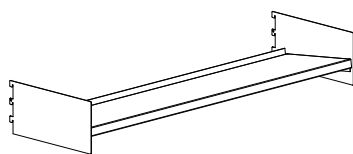

Module cm	Shelf depth cm	Dimension W X H cm	Item no.	Price EUR
75	22.5	25 x 15	BB30126174	99,08
75	22.5	30 x 15	BB30126171	99,08
75	25	30 x 15	BB30126275	99,08
75	30	35 x 20	BB30126372	118,64
75	30	40 x 15	BB30126376	118,64
75	30	40 x 20	BB30126373	118,64
90	22.5	25 x 15	BB30126194	99,08
90	22.5	30 x 15	BB30126191	99,08
90	25	30 x 15	BB30126295	99,08
90	30	35 x 20	BB30126392	118,64
90	30	40 x 15	BB30126396	118,64
90	30	40 x 20	BB30126393	118,64
100	22.5	25 x 15	BB30126114	103,34
100	22.5	30 x 15	BB30126111	103,34
100	25	30 x 15	BB30126215	103,34
100	30	35 x 20	BB30126312	124,22
100	30	40 x 15	BB30126316	124,22
100	30	40 x 20	BB30126313	124,22

SHELVES

S2 STEEL SHELF WITH ACRYLIC BACKEDGE

S2 steel shelf with acrylic backedge - for hanging book support

Acrylic backedge 17 mm. Left, right or double brackets must be ordered separately. See page 72. Note: Spot welding visible on top of surface.

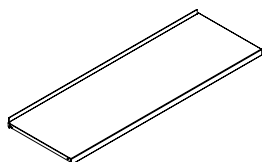

Module cm	Shelf depth cm	Item no.	Price EUR
75	22.5	B40101317	38,70
75	25	B40101327	38,70
75	30	B40101337	43,36
75	40	B40101347	72,62
90	22.5	B40101319	38,70
90	25	B40101329	38,70
90	30	B40101339	43,36
90	40	B40101349	72,62
100	22.5	B40101311	42,96
100	25	B40101321	42,96
100	30	B40101331	48,94
100	40	B40101341	81,40

Hanging book support - for S2

Available in chromed steel or standard steel colours.



Height cm	Item no.	Price EUR
20	B4011242	9,04
25	B4011245	9,71

SHELVES

BRACKETS FOR S1 & S2

Steel plate bracket for S1 & S2

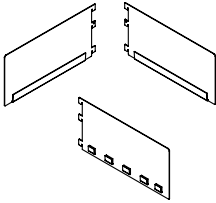

Type	Shelf depth cm	Item no. H15 cm	Price EUR	Item no. H20 cm	Price EUR
Left	22,5	B30101417	13,17	B30102017	18,62
Left	25	B30101427	14,76	B30102027	20,22
Left	30	B30101437	15,30	B30102037	21,68
Left	40	B30101447	18,62	B30102047	24,87
Right	22,5	B30101418	13,17	B30102018	18,62
Right	25	B30101428	14,76	B30102028	20,22
Right	30	B30101438	15,30	B30102038	21,68
Right	40	B30101448	18,62	B30102048	24,87
Double	22,5	B30101419	14,76		
Double	25	B30101429	15,16		
Double	30	B30101439	16,36		
Double	40	B30101449	20,22		

45°/60° steel plate bracket - for S1 & S2

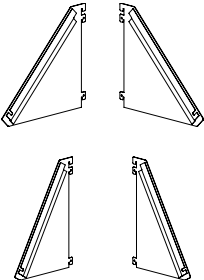

Depth cm	Degree	Item no. Left	Price EUR	Item no. Right	Price EUR
22.5	45°	B3010321458	37,64	B3010321459	37,64
25	45°	B3010322458	37,64	B3010322459	37,64
30	45°	B3010323458	37,64	B3010323459	37,64
22.5	60°	B3010321608	37,64	B3010321609	37,64
25	60°	B3010322608	37,64	B3010322609	37,64
30	60°	B3010323608	37,64	B3010323609	37,64

7.5° reverse tilted steel plate bracket - for S1 & S2

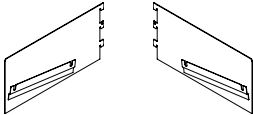

Shelf depth cm	Dimension W X H cm	Item no. Left	Price EUR	Item no. Right	Price EUR
22.5	25 x 15	B30114048	30,19	B30114049	30,19
22.5	30 x 15	B30114018	30,19	B30114019	30,19
25	30 x 15	B30114058	30,19	B30114059	30,19
30	35 x 20	B30114028	37,64	B30114029	37,64
30	40 x 15	B30114068	37,64	B30114069	37,64
30	40 x 20	B30114038	37,64	B30114039	37,64

Steel brackets for various shelf depths - for S1 & S2

Brackets for shelves with shorter depth than actual shelving system. This places the shelf in line with the front of shelving system.

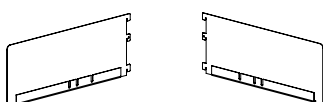

Depth cm	For shelving depths cm	Item no. Left	Price EUR	Item no. Right	Price EUR
25	22.5	B30102628	19,42	B30102629	19,42
30	22.5, 25	B30102638	20,62	B30102639	20,62
40	22.5, 25, 30	B30102648	24,34	B30102649	24,34

SHELVES

STEEL BOTTOM SHELF WITH BACKEDGE AND INTEGRATED PLINTH

Steel bottom shelf with steel backedge and integrated plinth - for backedge book support

Steel backedge H47 mm, integrated plinth H92 mm. Brackets must be ordered separately. See below. Does not fit Classic Steel 80/30.

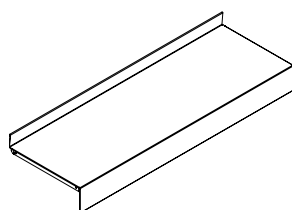

Module cm	Shelf depth cm	Item no.	Price EUR
75	22.5	B30141017	54,13
75	25	B30141027	57,86
75	30	B30141037	61,18
75	40	B30141047	74,75
90	22.5	B30141019	59,98
90	25	B30141029	60,91
90	30	B30141039	67,03
90	40	B30141049	86,85
100	22.5	B30141011	65,44
100	25	B30141021	69,03
100	30	B30141031	74,08
100	40	B30141041	90,57

Steel plate brackets for steel bottom shelf with steel backedge and integrated plinth

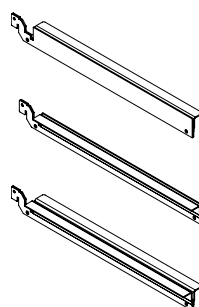

Type	Shelf depth cm	Item no.	Price EUR
Left	22.5	B30141417	37,37
Left	25	B30141427	42,96
Left	30	B30141437	46,02
Left	40	B30141447	55,20
Right	22.5	B30141418	37,37
Right	25	B30141428	42,96
Right	30	B30141438	46,02
Right	40	B30141448	55,20
Double	22.5	B30141419	42,96
Double	25	B30141429	45,09
Double	30	B30141439	47,75
Double	40	B30141449	59,45

SHELVES

SINGLE-SIDED STEEL TOP SHELVES

See below for overview of standard steel top shelves:

B401003 - SINGLE-SIDED STEEL TOP SHELF - 25 MM FRONTEDGE

Details:

- Module 750/900/1000 mm
- Depth 225/250/300/400 mm
- Steel brackets
- Max. weight 25 kg.
- Use with steel shelves with steel backedge for backedge book support

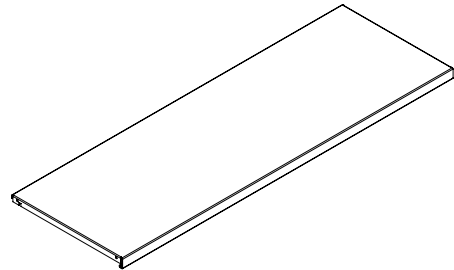

B401005 - SINGLE-SIDED STEEL TOP SHELF - SIGN PROFILE

Details:

- Module 750/900/1000 mm
- Depth 225/250/300/400 mm
- Steel brackets
- Max. weight 25 kg.
- Use with steel shelves with steel backedge for backedge book support

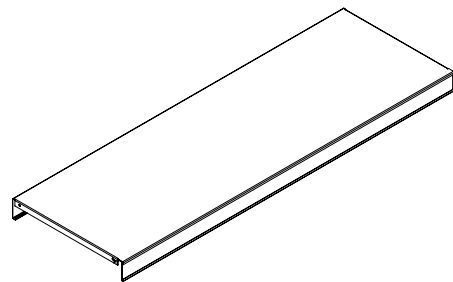

B401011 - SINGLE-SIDED STEEL TOP SHELF - 25 MM FRONTEDGE

Details:

- Module 750/900/1000 mm
- Depth 250/300/400 mm
- Steel brackets
- Max. weight 25 kg.
- Use with steel shelves with acrylic backedge for hanging book support

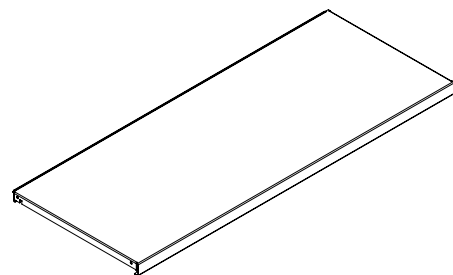

SHELVES

SINGLE- & DOUBLE-SIDED STEEL TOP SHELVES & LONDON TOP PLATE

See below for overview of standard steel top shelves:

B301049 - SINGLE-SIDED STEEL TOP SHELF - 25/47 MM FRONTEDGE

Details:

- Module 750/900/1000 mm
- Depth 225/250/300/400 mm
- Steel brackets
- Max. weight 25 kg.
- 1/2 bays
- Use with steel shelves with steel backedge for backedge book support

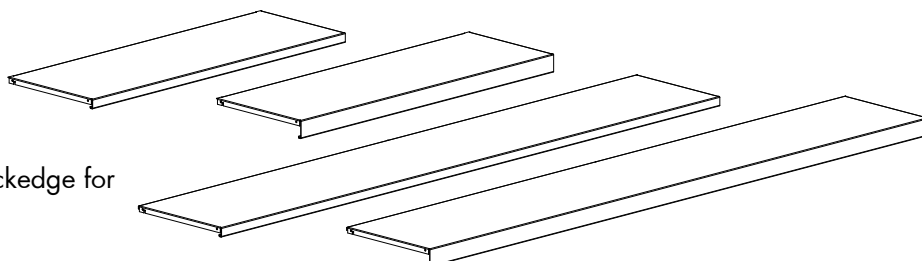

B301046 - DOUBLE-SIDED STEEL TOP SHELF - 25/47 MM FRONTEDGE

Details:

- Module 750/900/1000 mm
- Depth 225/250/300/400 mm
- Freestanding/outer/intermediate
- Steel brackets
- Max. weight 25 kg.
- 1/2 bays
- Use with steel shelves with steel backedge for backedge book support

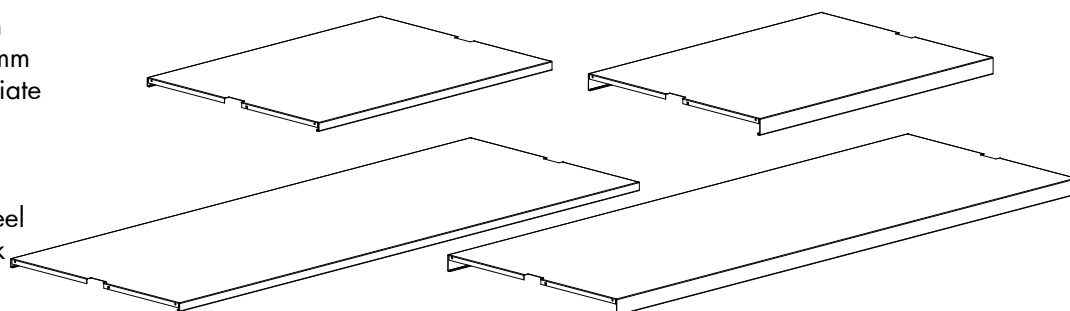

B301628 - SINGLE-SIDED LONDON STEEL TOP PLATE - 30 MM FRONTEDGE

Details:

- Module 750/900/1000 mm
- Depth 225/250/300/400 mm
- Freestanding/outer/intermediate
- Steel brackets
- Max. weight 25 kg.
- 1/2 bays

B301628 - DOUBLE-SIDED LONDON STEEL TOP PLATE - 30 MM FRONTEDGE

Details:

- Module 750/900/1000 mm
- Depth 225/250/300/400 mm
- Freestanding/outer/intermediate
- Steel brackets
- Max. weight 25 kg.
- 1/2 bays

SHELVES

SINGLE-SIDED STEEL TOP SHELVES - 25 MM FRONTEDGE - FOR BACKEDGE BOOK SUPPORT

Steel top shelf with brackets - to be used with steel shelves for backedge book support

Incl. H7.5 cm brackets. Top shelves for starter bays include left and right brackets. Top shelves for add-on bays include double bracket.

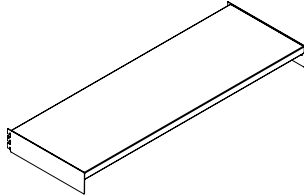

Module cm	Shelf depth cm	Item no. Starter bay	Price EUR	Item no. Add-on bay	Price EUR
75	22.5	BB4007621217	82,85	BB4007622217	68,63
75	25	BB4007621227	84,19	BB4007622227	69,96
75	30	BB4007621237	92,84	BB4007622237	78,60
75	40	BB4007621247	105,33	BB4007622247	89,77
90	22.5	BB4007621219	84,72	BB4007622219	70,50
90	25	BB4007621229	90,44	BB4007622229	76,21
90	30	BB4007621239	95,90	BB4007622239	81,66
90	40	BB4007621249	115,18	BB4007622249	99,62
100	22.5	BB4007621211	93,49	BB4007622211	79,27
100	25	BB4007621221	97,75	BB4007622221	83,52
100	30	BB4007621231	102,02	BB4007622231	87,78
100	40	BB4007621241	119,57	BB4007622241	104,01

Steel top shelf without brackets - to be used with steel shelves for backedge book support

Brackets must be ordered separately. A top shelf for starter bays must have a left and a right bracket. Top shelves for add-on bays must have a double bracket. See below.

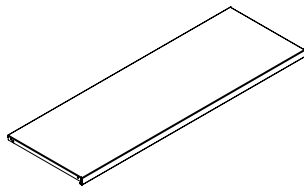

Module cm	Shelf depth cm	Item no.	Price EUR
75	22.5	B40100317	53,33
75	25	B40100327	53,87
75	30	B40100337	62,24
75	40	B40100347	71,55
90	22.5	B40100319	55,20
90	25	B40100329	60,12
90	30	B40100339	65,30
90	40	B40100349	81,40
100	22.5	B40100311	63,97
100	25	B40100321	67,43
100	30	B40100331	71,42
100	40	B40100341	85,79

Steel bracket for steel top shelf

H7.5 cm. Max. load of 25 kg.

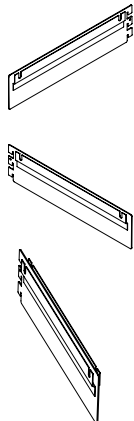

Type	Shelf depth cm	Item no.	Price EUR
Left	22.5	B30102417	14,76
Left	25	B30102427	15,16
Left	30	B30102437	15,30
Left	40	B30102447	16,89
Right	22.5	B30102418	14,76
Right	25	B30102428	15,16
Right	30	B30102438	15,30
Right	40	B30102448	16,89
Double	22.5	B30102419	15,30
Double	25	B30102429	16,09
Double	30	B30102439	16,36
Double	40	B30102449	18,22

SHELVES

SINGLE-SIDED STEEL TOP SHELVES - SIGN PROFILE - FOR BACKEDGE BOOK SUPPORT

Steel top shelf with sign profile and brackets - to be used with steel shelves for backedge book support

Incl. brackets. Label B401130 to be ordered separately. Top shelves for starter bays include left and right brackets. Top shelves for add-on bays include double bracket.

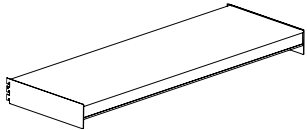
	Module cm	Shelf depth cm	Item no. Starter bay	Price EUR	Item no. Add-on bay	Price EUR
	75	22.5	BB400752117	115,70	BB400752217	101,48
	75	25	BB400752127	119,70	BB400752227	105,47
	75	30	BB400752137	124,50	BB400752237	110,26
	75	40	BB400752147	136,46	BB400752247	120,90
	90	22.5	BB400752119	120,36	BB400752219	106,14
	90	25	BB400752129	124,48	BB400752229	110,25
	90	30	BB400752139	127,69	BB400752239	113,45
	90	40	BB400752149	146,03	BB400752249	130,47
	100	22.5	BB400752111	129,40	BB400752211	115,18
	100	25	BB400752121	131,27	BB400752221	117,04
	100	30	BB400752131	136,47	BB400752231	122,23
	100	40	BB400752141	152,28	BB400752241	136,72

Steel top shelf with sign profile without brackets - to be used with steel shelves for backedge book support

Brackets and label B401130 must be ordered separately. A top shelf for starter bays must have a left and a right bracket. Top shelves for add-on bays must have a double bracket. See below.

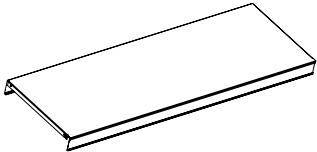
	Module cm	Shelf depth cm	Item no.	Price EUR
	75	22.5	B40100517	86,18
	75	25	B40100527	89,38
	75	30	B40100537	93,90
	75	40	B40100547	102,68
	90	22.5	B40100519	90,84
	90	25	B40100529	94,16
	90	30	B40100539	97,09
	90	40	B40100549	112,25
	100	22.5	B40100511	99,88
	100	25	B40100521	100,95
	100	30	B40100531	105,87
	100	40	B40100541	118,50

Steel bracket for steel top shelf

H7.5 cm. Max. load of 25 kg.

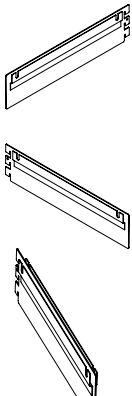
	Type	Shelf depth cm	Item no.	Price EUR
	Left	22.5	B30102417	14,76
	Left	25	B30102427	15,16
	Left	30	B30102437	15,30
	Left	40	B30102447	16,89
	Right	22.5	B30102418	14,76
	Right	25	B30102428	15,16
	Right	30	B30102438	15,30
	Right	40	B30102448	16,89
	Double	22.5	B30102419	15,30
	Double	25	B30102429	16,09
	Double	30	B30102439	16,36
	Double	40	B30102449	18,22

SHELVES

SINGLE-SIDED STEEL TOP SHELVES - 25 MM FRONTEDGE - FOR HANGING BOOK SUPPORT

Steel top shelf with brackets - to be used with shelves for hanging book support

Incl. H7.5 cm lower brackets. Top shelves for starter bays include left and right brackets. Top shelves for add-on bays include double bracket.

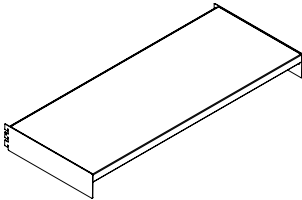

Module cm	Shelf depth cm	Item no. Starter bay	Price EUR	Item no. Add-on bay	Price EUR
75	22.5	BB4007721217	63,70	BB4007722217	49,48
75	25	BB4007721227	64,50	BB4007722227	50,27
75	30	BB4007721237	69,30	BB4007722237	55,06
75	40	BB4007721247	106,40	BB4007722247	90,84
90	22.5	BB4007721219	63,70	BB4007722219	49,48
90	25	BB4007721229	64,50	BB4007722229	50,27
90	30	BB4007721239	69,30	BB4007722239	55,06
90	40	BB4007721249	106,40	BB4007722249	90,84
100	22.5	BB4007721211	72,21	BB4007722211	57,99
100	25	BB4007721221	73,01	BB4007722221	58,78
100	30	BB4007721231	73,56	BB4007722231	59,32
1000	40	BB4007721241	115,18	BB4007722241	99,62

Steel top shelf without brackets - to be used with shelves for hanging book support

Brackets must be ordered separately. A top shelf for starter bays must have a left and a right bracket. Top shelves for add-on bays must have a double bracket. See below.

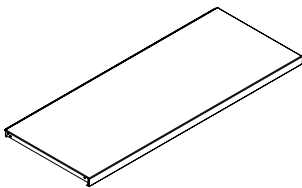

Module cm	Shelf depth cm	Item no.	Price EUR
75	22,5	B40101117	34,18
75	25	B40101127	34,18
75	30	B40101137	38,70
75	40	B40101147	72,62
90	22,5	B40101119	34,18
90	25	B40101129	34,18
90	30	B40101139	38,70
90	40	B40101149	72,62
100	22,5	B40101111	42,69
100	25	B40101121	42,69
100	30	B40101131	42,96
100	40	B40101141	81,40

Steel bracket for steel top shelf

H7.5 cm. Max. load of 25 kg.

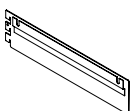
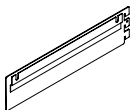

Type	Shelf depth cm	Item no.	Price EUR
Left	22.5	B30102417	14,76
Left	25	B30102427	15,16
Left	30	B30102437	15,30
Left	40	B30102447	16,89
Right	22.5	B30102418	14,76
Right	25	B30102428	15,16
Right	30	B30102438	15,30
Right	40	B30102448	16,89
Double	22.5	B30102419	15,30
Double	25	B30102429	16,09
Double	30	B30102439	16,36
Double	40	B30102449	18,22



SHELVES

SINGLE-SIDED STEEL TOP SHELF - 25 MM FRONTEDGE - WITH BRACKETS

Single-sided steel top shelf with brackets - to be used with steel shelves for backedge book support - for 1 bay

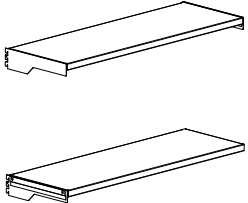
Incl. brackets. Top shelves for starter bays include left and right brackets. Top shelves for add-on bays include double bracket.	Module cm	Shelf depth cm	Item no. Starter bay	Price EUR	Item no. Add-on bay	Price EUR
	75	22.5	BB30117171125	115,70	BB30117271125	101,48
	75	25	BB30117172125	119,70	BB30117272125	105,47
	75	30	BB30117173125	124,50	BB30117273125	110,26
	75	40	BB30117174125	136,46	BB30117274125	120,90
	90	22.5	BB30117191125	120,36	BB30117291125	106,14
	90	25	BB30117192125	124,48	BB30117292125	110,25
	90	30	BB30117193125	127,69	BB30117293125	113,45
	90	40	BB30117194125	146,03	BB30117294125	130,47
	100	22.5	BB30117111125	129,40	BB30117211125	115,18
	100	25	BB30117112125	131,27	BB30117212125	117,04
	100	30	BB30117113125	136,47	BB30117213125	122,23
	100	40	BB30117114125	152,28	BB30117214125	136,72

Single-sided steel top shelf with brackets - to be used with steel shelves for backedge book support - for 2 bays

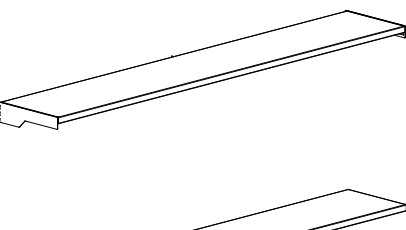
Incl. brackets. Top shelves for starter bays include left, middle and right brackets. Top shelves for add-on bays include middle and double bracket.	Module cm	Shelf depth cm	Item no. Starter bay	Price EUR	Item no. Add-on bay	Price EUR
	75	22.5	BB30117171225	181,14	BB30117271225	166,92
	75	25	BB30117172225	187,79	BB30117272225	173,56
	75	30	BB30117173225	195,92	BB30117273225	181,68
	75	40	BB30117174225	214,39	BB30117274225	198,83
	90	22.5	BB30117191225	189,25	BB30117291225	175,03
	90	25	BB30117192225	196,04	BB30117292225	181,81
	90	30	BB30117193225	201,37	BB30117293225	187,13
	90	40	BB30117194225	231,15	BB30117294225	215,59
	100	22.5	BB30117111225	205,35	BB30117211225	191,13
	100	25	BB30117112225	207,88	BB30117212225	193,65
	100	30	BB30117113225	217,07	BB30117213225	202,83
	100	40	BB30117114225	242,19	BB30117214225	226,63

SHELVES

SINGLE-SIDED STEEL TOP SHELF - 25 MM FRONTEDGE

Single-sided steel top shelf without brackets - to be used with steel shelves for backedge book support - for 1 bay

Brackets must be ordered separately. A top shelf for starter bays must have a left and a right bracket. Top shelves for add-on bays must have a double bracket. See page 96.



Module cm	Shelf depth cm	Item no.	Price EUR
75	22.5	B30104971125	86,18
75	25	B30104972125	89,38
75	30	B30104973125	93,90
75	40	B30104974125	102,68
90	22.5	B30104991125	90,84
90	25	B30104992125	94,16
90	30	B30104993125	97,09
90	40	B30104994125	112,25
100	22.5	B30104911125	99,88
100	25	B30104912125	100,95
100	30	B30104913125	105,87
100	40	B30104914125	118,50

Single-sided steel top shelf without brackets - to be used with steel shelves for backedge book support - for 2 bays

Brackets must be ordered separately. A top shelf for starter bays must have a left, a middle and a right bracket. Top shelves for add-on bays must have a middle and a double bracket. See page 96.

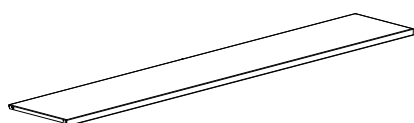

Module cm	Shelf depth cm	Item no.	Price EUR
75	22.5	B30104971225	151,62
75	25	B30104972225	157,47
75	30	B30104973225	165,32
75	40	B30104974225	180,61
90	22.5	B30104991225	159,73
90	25	B30104992225	165,72
90	30	B30104993225	170,77
90	40	B30104994225	197,37
100	22.5	B30104911225	175,83
100	25	B30104912225	177,56
100	30	B30104913225	186,47
100	40	B30104914225	208,41

SHELVES

SINGLE-SIDED STEEL TOP SHELF - 47 MM FRONTEDGE - WITH BRACKETS

Single-sided steel top shelf with brackets - to be used with steel shelves for backedge book support - for 1 bay

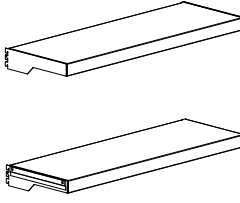
Incl. brackets. Top shelves for starter bays include left and right brackets. Top shelves for add-on bays include double bracket.	Module cm	Shelf depth cm	Item no. Starter bay	Price EUR	Item no. Add-on bay	Price EUR
	75	22.5	BB30117171147	115,70	BB30117271147	101,48
	75	25	BB30117172147	119,70	BB30117272147	105,47
	75	30	BB30117173147	124,50	BB30117273147	110,26
	75	40	BB30117174147	136,46	BB30117274147	120,90
	90	22.5	BB30117191147	120,36	BB30117291147	106,14
	90	25	BB30117192147	124,48	BB30117292147	110,25
	90	30	BB30117193147	127,69	BB30117293147	113,45
	90	40	BB30117194147	146,03	BB30117294147	130,47
	100	22.5	BB30117111147	129,40	BB30117211147	115,18
	100	25	BB30117112147	131,27	BB30117212147	117,04
	100	30	BB30117113147	136,47	BB30117213147	122,23
	100	40	BB30117114147	152,28	BB30117214147	136,72

Single-sided steel top shelf with brackets - to be used with steel shelves for backedge book support - for 2 bays

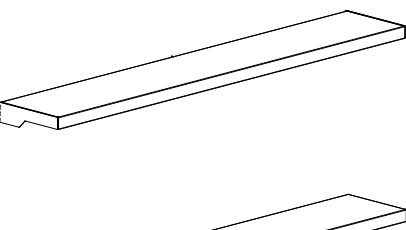
Incl. brackets. Top shelves for starter bays include left, middle and right brackets. Top shelves for add-on bays include middle and double bracket.	Module cm	Shelf depth cm	Item no. Starter bay	Price EUR	Item no. Add-on bay	Price EUR
	75	22.5	BB30117171247	181,14	BB30117271247	166,92
	75	25	BB30117172247	187,79	BB30117272247	173,56
	75	30	BB30117173247	195,92	BB30117273247	181,68
	75	40	BB30117174247	214,39	BB30117274247	198,83
	90	22.5	BB30117191247	189,25	BB30117291247	175,03
	90	25	BB30117192247	196,04	BB30117292247	181,81
	90	30	BB30117193247	201,37	BB30117293247	187,13
	90	40	BB30117194247	231,15	BB30117294247	215,59
	100	22.5	BB30117111247	205,35	BB30117211247	191,13
	100	25	BB30117112247	207,88	BB30117212247	193,65
	100	30	BB30117113247	217,07	BB30117213247	202,83
	100	40	BB30117114247	242,19	BB30117214247	226,63

SHELVES

SINGLE-SIDED STEEL TOP SHELF - 47 MM FRONTEDGE

Single-sided steel top shelf without brackets - to be used with steel shelves for backedge book support - for 1 bay

Brackets must be ordered separately. A top shelf for starter bays must have a left and a right bracket. Top shelves for add-on bays must have a double bracket. See page 96.

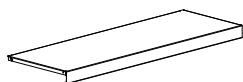

Module cm	Shelf depth cm	Item no.	Price EUR
75	22.5	B30104971147	86,18
75	25	B30104972147	89,38
75	30	B30104973147	93,90
75	40	B30104974147	102,68
90	22.5	B30104991147	90,84
90	25	B30104992147	94,16
90	30	B30104993147	97,09
90	40	B30104994147	112,25
100	22.5	B30104911147	99,88
100	25	B30104912147	100,95
100	30	B30104913147	105,87
100	40	B30104914147	118,50

Single-sided steel top shelf without brackets - to be used with steel shelves for backedge book support - for 2 bays

Brackets must be ordered separately. A top shelf for starter bays must have a left, a middle and a right bracket. Top shelves for add-on bays must have a middle and a double bracket. See page 96.

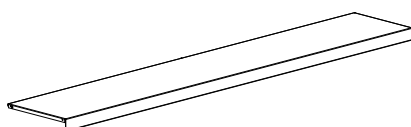

Module cm	Shelf depth cm	Item no.	Price EUR
75	22.5	B30104971247	151,62
75	25	B30104972247	157,47
75	30	B30104973247	165,32
75	40	B30104974247	180,61
90	22.5	B30104991247	159,73
90	25	B30104992247	165,72
90	30	B30104993247	170,77
90	40	B30104994247	197,37
100	22.5	B30104911247	175,83
100	25	B30104912247	177,56
100	30	B30104913247	186,47
100	40	B30104914247	208,41

SHELVES

DOUBLE-SIDED STEEL TOP SHELVES - 25 MM FRONTEDGE - FREESTANDING - WITH BRACKETS

Double-sided steel top shelf with brackets - for 1 freestanding bay

2 left and 2 right brackets included.

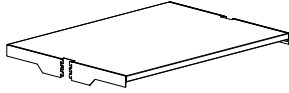

No. of bays	Frontedge cm	Module cm	Shelf depth cm	Item no.	Price EUR
1	25	75	22.5	BB30115719125	231,41
1	25	75	25	BB30115729125	239,53
1	25	75	30	BB30115739125	249,00
1	25	75	40	BB30115749125	272,91
1	25	90	22.5	BB30115919125	240,59
1	25	90	25	BB30115929125	249,10
1	25	90	30	BB30115939125	255,38
1	25	90	40	BB30115949125	291,93
1	25	100	22.5	BB30115119125	258,94
1	25	100	25	BB30115129125	262,40
1	25	100	30	BB30115139125	273,07
1	25	100	40	BB30115149125	304,43

Double-sided steel top shelf with brackets - for 2 freestanding bays

2 left, 2 middle and 2 right brackets included.

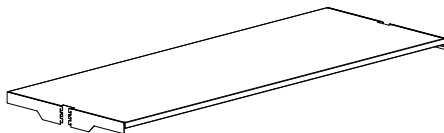

No. of bays	Frontedge cm	Module cm	Shelf depth cm	Item no.	Price EUR
2	25	75	22.5	BB30115719225	362,41
2	25	75	25	BB30115729225	375,45
2	25	75	30	BB30115739225	391,84
2	25	75	40	BB30115749225	428,92
2	25	90	22.5	BB30115919225	378,64
2	25	90	25	BB30115929225	392,21
2	25	90	30	BB30115939225	402,88
2	25	90	40	BB30115949225	462,44
2	25	100	22.5	BB30115119225	410,83
2	25	100	25	BB30115129225	415,75
2	25	100	30	BB30115139225	434,00
2	25	100	40	BB30115149225	484,52

SHELVES

DOUBLE-SIDED STEEL TOP SHELVES - 25 MM FRONTEDGE - FREESTANDING

Double-sided steel top shelf without brackets - for 1 freestanding bay

2 left and 2 right brackets must be ordered separately. See page 96.

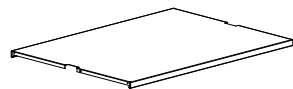

No. of bays	Frontedge cm	Module cm	Shelf depth cm	Item no.	Price EUR
1	25	75	22.5	B301046719125	172,37
1	25	75	25	B301046729125	178,89
1	25	75	30	B301046739125	187,80
1	25	75	40	B301046749125	205,35
1	25	90	22.5	B301046919125	181,55
1	25	90	25	B301046929125	188,46
1	25	90	30	B301046939125	194,18
1	25	90	40	B301046949125	224,37
1	25	100	22.5	B301046119125	199,90
1	25	100	25	B301046129125	201,76
1	25	100	30	B301046139125	211,87
1	25	100	40	B301046149125	236,87

Double-sided steel top shelf without brackets - for 2 freestanding bays

2 left, 2 middle and 2 right brackets must be ordered separately. See page 96.

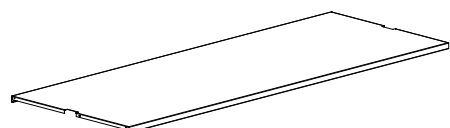

No. of bays	Frontedge cm	Module cm	Shelf depth cm	Item no.	Price EUR
2	25	75	22.5	B301046719225	303,37
2	25	75	25	B301046729225	314,81
2	25	75	30	B301046739225	330,64
2	25	75	40	B301046749225	361,36
2	25	90	22.5	B301046919225	319,60
2	25	90	25	B301046929225	331,57
2	25	90	30	B301046939225	341,68
2	25	90	40	B301046949225	394,88
2	25	100	22.5	B301046119225	351,79
2	25	100	25	B301046129225	355,11
2	25	100	30	B301046139225	372,80
2	25	100	40	B301046149225	416,96

SHELVES

DOUBLE-SIDED STEEL TOP SHELVES - 25 MM FRONTEDGE - OUTER - WITH BRACKETS

Double-sided steel top shelf with brackets - for 1 outer bay

1 left, 1 right and 1 double bracket included.

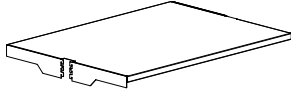

No. of bays	Frontedge cm	Module cm	Shelf depth cm	Item no.	Price EUR
1	25	75	22.5	BB30115718125	217,19
1	25	75	25	BB30115728125	225,30
1	25	75	30	BB30115738125	234,76
1	25	75	40	BB30115748125	257,35
1	25	90	22.5	BB30115918125	226,37
1	25	90	25	BB30115928125	234,87
1	25	90	30	BB30115938125	241,14
1	25	90	40	BB30115948125	276,37
1	25	100	22.5	BB30115118125	244,72
1	25	100	25	BB30115128125	248,17
1	25	100	30	BB30115138125	258,83
1	25	100	40	BB30115148125	288,87

Double-sided steel top shelf with brackets - for 2 outer bays

1 left, 1 right, 1 double and 2 middle brackets included.

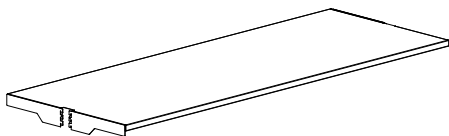

No. of bays	Frontedge cm	Module cm	Shelf depth cm	Item no.	Price EUR
2	25	75	22.5	BB30115718225	348,19
2	25	75	25	BB30115728225	361,22
2	25	75	30	BB30115738225	377,60
2	25	75	40	BB30115748225	413,36
2	25	90	22.5	BB30115918225	364,42
2	25	90	25	BB30115928225	377,98
2	25	90	30	BB30115938225	388,64
2	25	90	40	BB30115948225	446,88
2	25	100	22.5	BB30115118225	396,61
2	25	100	25	BB30115128225	401,52
2	25	100	30	BB30115138225	419,76
2	25	100	40	BB30115148225	468,96

SHELVES

DOUBLE-SIDED STEEL TOP SHELVES - 25 MM FRONTEDGE - OUTER

Double-sided steel top shelf without brackets - for 1 outer bay

1 left, 1 right and 1 double bracket must be ordered separately. See page 96.

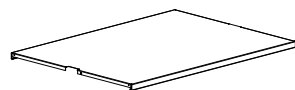

No. of bays	Frontedge cm	Module cm	Shelf depth cm	Item no.	Price EUR
1	25	75	22.5	B301046718125	172,37
1	25	75	25	B301046728125	178,89
1	25	75	30	B301046738125	187,80
1	25	75	40	B301046748125	205,35
1	25	90	22.5	B301046718147	172,37
1	25	90	25	B301046728147	178,89
1	25	90	30	B301046738147	187,80
1	25	90	40	B301046748147	205,35
1	25	100	22.5	B301046918125	181,55
1	25	100	25	B301046928125	188,46
1	25	100	30	B301046938125	194,18
1	25	100	40	B301046948125	224,37

Double-sided steel top shelf without brackets - for 2 outer bays

1 left, 1 right, 1 double and 2 middle brackets must be ordered separately. See page 96.

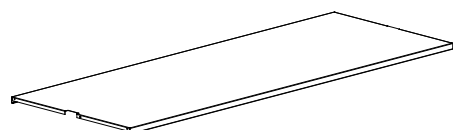

No. of bays	Frontedge cm	Module cm	Shelf depth cm	Item no.	Price EUR
2	25	75	22.5	B301046718225	303,37
2	25	75	25	B301046728225	314,81
2	25	75	30	B301046738225	330,64
2	25	75	40	B301046748225	361,36
2	25	90	22.5	B301046718247	303,37
2	25	90	25	B301046728247	314,81
2	25	90	30	B301046738247	330,64
2	25	90	40	B301046748247	361,36
2	25	100	22.5	B301046918225	319,60
2	25	100	25	B301046928225	331,57
2	25	100	30	B301046938225	341,68
2	25	100	40	B301046948225	394,88

SHELVES

DOUBLE-SIDED STEEL TOP SHELVES - 25 MM FRONTEDGE - INTERMEDIATE - WITH BRACKETS

Double-sided steel top shelf with brackets - for 1 intermediate bay

2 double brackets included.

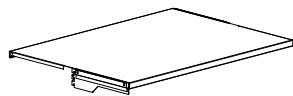

No. of bays	Frontedge cm	Module cm	Shelf depth cm	Item no.	Price EUR
1	25	75	22.5	BB30115717125	202,97
1	25	75	25	BB30115727125	211,07
1	25	75	30	BB30115737125	220,52
1	25	75	40	BB30115747125	241,79
1	25	90	22.5	BB30115917125	212,15
1	25	90	25	BB30115927125	220,64
1	25	90	30	BB30115937125	226,90
1	25	90	40	BB30115947125	260,81
1	25	100	22.5	BB30115117125	230,50
1	25	100	25	BB30115127125	233,94
1	25	100	30	BB30115137125	244,59
1	25	100	40	BB30115147125	273,31

Double-sided steel top shelf with brackets - for 2 intermediate bays

2 double and 2 middle brackets included.

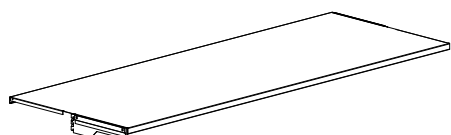

No. of bays	Frontedge cm	Module cm	Shelf depth cm	Item no.	Price EUR
2	25	75	22.5	BB30115717225	333,97
2	25	75	25	BB30115727225	346,99
2	25	75	30	BB30115737225	363,36
2	25	75	40	BB30115747225	397,80
2	25	90	22.5	BB30115917225	350,20
2	25	90	25	BB30115927225	363,75
2	25	90	30	BB30115937225	374,40
2	25	90	40	BB30115947225	431,32
2	25	100	22.5	BB30115117225	382,39
2	25	100	25	BB30115127225	387,29
2	25	100	30	BB30115137225	405,52
2	25	100	40	BB30115147225	453,40

SHELVES

DOUBLE-SIDED STEEL TOP SHELVES - 25 MM FRONTEDGE - INTERMEDIATE

Double-sided steel top shelf without brackets - for 1 intermediate bay

2 double brackets must be ordered separately. See page 96.

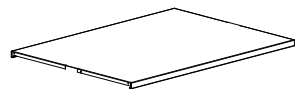

No. of bays	Frontedge cm	Module cm	Shelf depth cm	Item no.	Price EUR
1	25	75	22.5	B301046717125	172,37
1	25	75	25	B301046727125	178,89
1	25	75	30	B301046737125	187,80
1	25	75	40	B301046747125	205,35
1	25	90	22.5	B301046917125	181,55
1	25	90	25	B301046927125	188,46
1	25	90	30	B301046937125	194,18
1	25	90	40	B301046947125	224,37
1	25	100	22.5	B301046117125	199,90
1	25	100	25	B301046127125	201,76
1	25	100	30	B301046137125	211,87
1	25	100	40	B301046147125	236,87

Double-sided steel top shelf without brackets - for 2 intermediate bays

2 double and 2 middle brackets must be ordered separately. See page 96.

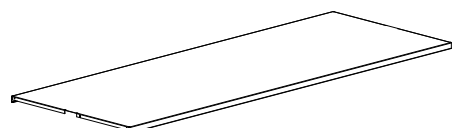

No. of bays	Frontedge cm	Module cm	Shelf depth cm	Item no.	Price EUR
2	25	75	22.5	B301046717225	303,37
2	25	75	25	B301046727225	314,81
2	25	75	30	B301046737225	330,64
2	25	75	40	B301046747225	361,36
2	25	90	22.5	B301046917225	319,60
2	25	90	25	B301046927225	331,57
2	25	90	30	B301046937225	341,68
2	25	90	40	B301046947225	394,88
2	25	100	22.5	B301046117225	351,79
2	25	100	25	B301046127225	355,11
2	25	100	30	B301046137225	372,80
2	25	100	40	B301046147225	416,96

SHELVES

DOUBLE-SIDED STEEL TOP SHELVES - 47 MM FRONTEDGE - FREESTANDING - WITH BRACKETS

Double-sided steel top shelf with brackets - for 1 freestanding bay

2 left and 2 right brackets included.

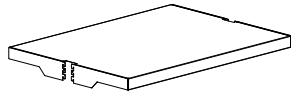

No. of bays	Frontedge cm	Module cm	Shelf depth cm	Item no.	Price EUR
1	47	75	22.5	BB30115719147	231,41
1	47	75	25	BB30115729147	239,53
1	47	75	30	BB30115739147	249,00
1	47	75	40	BB30115749147	272,91
1	47	90	22.5	BB30115919147	240,59
1	47	90	25	BB30115929147	249,10
1	47	90	30	BB30115939147	255,38
1	47	90	40	BB30115949147	291,93
1	47	100	22.5	BB30115119147	258,94
1	47	100	25	BB30115129147	262,40
1	47	100	30	BB30115139147	273,07
1	47	100	40	BB30115149147	304,43

Double-sided steel top shelf with brackets - for 2 freestanding bays

2 left, 2 middle and 2 right brackets included.

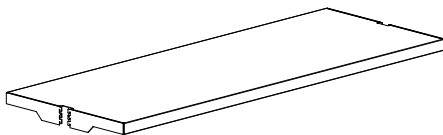

No. of bays	Frontedge cm	Module cm	Shelf depth cm	Item no.	Price EUR
2	47	75	22.5	BB30115719247	362,41
2	47	75	25	BB30115729247	375,45
2	47	75	30	BB30115739247	391,84
2	47	75	40	BB30115749247	428,92
2	47	90	22.5	BB30115919247	378,64
2	47	90	25	BB30115929247	392,21
2	47	90	30	BB30115939247	402,88
2	47	90	40	BB30115949247	462,44
2	47	100	22.5	BB30115119247	410,83
2	47	100	25	BB30115129247	415,75
2	47	100	30	BB30115139247	434,00
2	47	100	40	BB30115149247	484,52

SHELVES

DOUBLE-SIDED STEEL TOP SHELVES - 47 MM FRONTEDGE - FREESTANDING

Double-sided steel top shelf without brackets - for 1 freestanding bay

2 left and 2 right brackets must be ordered separately. See page 96.

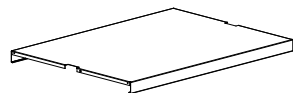

No. of bays	Frontedge cm	Module cm	Shelf depth cm	Item no.	Price EUR
1	47	75	22.5	B301046719147	172,37
1	47	75	25	B301046729147	178,89
1	47	75	30	B301046739147	187,80
1	47	75	40	B301046749147	205,35
1	47	90	22.5	B301046919147	181,55
1	47	90	25	B301046929147	188,46
1	47	90	30	B301046939147	194,18
1	47	90	40	B301046949147	224,37
1	47	100	22.5	B301046119147	199,90
1	47	100	25	B301046129147	201,76
1	47	100	30	B301046139147	211,87
1	47	100	40	B301046149147	236,87

Double-sided steel top shelf without brackets - for 2 freestanding bays

2 left, 2 middle and 2 right brackets must be ordered separately. See page 96.

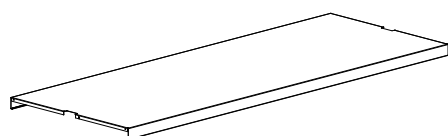

No. of bays	Frontedge cm	Module cm	Shelf depth cm	Item no.	Price EUR
2	47	75	22.5	B301046719247	303,37
2	47	75	25	B301046729247	314,81
2	47	75	30	B301046739247	330,64
2	47	75	40	B301046749247	361,36
2	47	90	22.5	B301046919247	319,60
2	47	90	25	B301046929247	331,57
2	47	90	30	B301046939247	341,68
2	47	90	40	B301046949247	394,88
2	47	100	22.5	B301046119247	351,79
2	47	100	25	B301046129247	355,11
2	47	100	30	B301046139247	372,80
2	47	100	40	B301046149247	416,96

SHELVES

DOUBLE-SIDED STEEL TOP SHELVES - 47 MM FRONTEDGE - OUTER - WITH BRACKETS

Double-sided steel top shelf with brackets - for 1 outer bay

1 left, 1 right and 1 double bracket included.

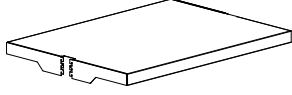

No. of bays	Frontedge cm	Module cm	Shelf depth cm	Item no.	Price EUR
1	47	75	22.5	BB30115718147	217,19
1	47	75	25	BB30115728147	225,30
1	47	75	30	BB30115738147	234,76
1	47	75	40	BB30115748147	257,35
1	47	90	22.5	BB30115918147	226,37
1	47	90	25	BB30115928147	234,87
1	47	90	30	BB30115938147	241,14
1	47	90	40	BB30115948147	276,37
1	47	100	22.5	BB30115118147	244,72
1	47	100	25	BB30115128147	248,17
1	47	100	30	BB30115138147	258,83
1	47	100	40	BB30115148147	288,87

Double-sided steel top shelf with brackets - for 2 outer bays

1 left, 1 right, 1 double and 2 middle brackets included.

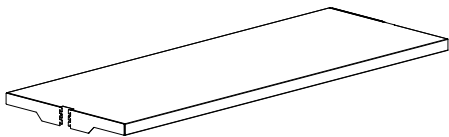

No. of bays	Frontedge cm	Module cm	Shelf depth cm	Item no.	Price EUR
2	47	75	22.5	BB30115718247	348,19
2	47	75	25	BB30115728247	361,22
2	47	75	30	BB30115738247	377,60
2	47	75	40	BB30115748247	413,36
2	47	90	22.5	BB30115918247	364,42
2	47	90	25	BB30115928247	377,98
2	47	90	30	BB30115938247	388,64
2	47	90	40	BB30115948247	446,88
2	47	100	22.5	BB30115118247	396,61
2	47	100	25	BB30115128247	401,52
2	47	100	30	BB30115138247	419,76
2	47	100	40	BB30115148247	468,96

SHELVES

DOUBLE-SIDED STEEL TOP SHELVES - 47 MM FRONTEDGE - OUTER

Double-sided steel top shelf without brackets - for 1 outer bay

1 left, 1 right and 1 double bracket must be ordered separately. See page 96.

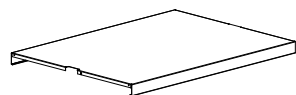

No. of bays	Frontedge cm	Module cm	Shelf depth cm	Item no.	Price EUR
1	47	75	22.5	B301046718147	172,37
1	47	75	25	B301046728147	178,89
1	47	75	30	B301046738147	187,80
1	47	75	40	B301046748147	205,35
1	47	90	22.5	B301046918147	181,55
1	47	90	25	B301046928147	188,46
1	47	90	30	B301046938147	194,18
1	47	90	40	B301046948147	224,37
1	47	100	22.5	B301046118147	199,90
1	47	100	25	B301046128147	201,76
1	47	100	30	B301046138147	211,87
1	47	100	40	B301046148147	236,87

Double-sided steel top shelf without brackets - for 2 outer bays

1 left, 1 right, 1 double and 2 middle brackets must be ordered separately. See page 96.

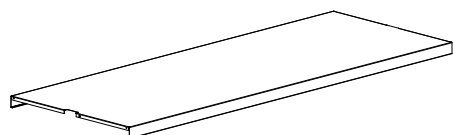

No. of bays	Frontedge cm	Module cm	Shelf depth cm	Item no.	Price EUR
2	47	75	22.5	B301046718247	303,37
2	47	75	25	B301046728247	314,81
2	47	75	30	B301046738247	330,64
2	47	75	40	B301046748247	361,36
2	47	90	22.5	B301046918247	319,60
2	47	90	25	B301046928247	331,57
2	47	90	30	B301046938247	341,68
2	47	90	40	B301046948247	394,88
2	47	100	22.5	B301046118247	351,79
2	47	100	25	B301046128247	355,11
2	47	100	30	B301046138247	372,80
2	47	100	40	B301046148247	416,96

SHELVES

DOUBLE-SIDED STEEL TOP SHELVES - 47 MM FRONTEDGE - INTERMEDIATE - WITH BRACKETS

Double-sided steel top shelf with brackets - for 1 intermediate bay

2 double brackets included.

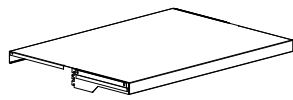

No. of bays	Frontedge cm	Module cm	Shelf depth cm	Item no.	Price EUR
1	47	75	22.5	BB30115717147	202,97
1	47	75	25	BB30115727147	211,07
1	47	75	30	BB30115737147	220,52
1	47	75	40	BB30115747147	241,79
1	47	90	22.5	BB30115917147	212,15
1	47	90	25	BB30115927147	220,64
1	47	90	30	BB30115937147	226,90
1	47	90	40	BB30115947147	260,81
1	47	100	22.5	BB30115117147	230,50
1	47	100	25	BB30115127147	233,94
1	47	100	30	BB30115137147	244,59
1	47	100	40	BB30115147147	273,31

Double-sided steel top shelf with brackets - for 2 intermediate bays

2 double and 2 middle brackets included.

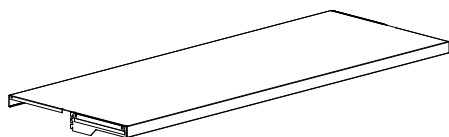

No. of bays	Frontedge cm	Module cm	Shelf depth cm	Item no.	Price EUR
2	47	75	22.5	BB30115717247	333,97
2	47	75	25	BB30115727247	346,99
2	47	75	30	BB30115737247	363,36
2	47	75	40	BB30115747247	397,80
2	47	90	22.5	BB30115917247	350,20
2	47	90	25	BB30115927247	363,75
2	47	90	30	BB30115937247	374,40
2	47	90	40	BB30115947247	431,32
2	47	100	22.5	BB30115117247	382,39
2	47	100	25	BB30115127247	387,29
2	47	100	30	BB30115137247	405,52
2	47	100	40	BB30115147247	453,40

SHELVES

DOUBLE-SIDED STEEL TOP SHELVES - 47 MM FRONTEDGE - INTERMEDIATE

Double-sided steel top shelf without brackets - for 1 intermediate bay

2 double brackets must be ordered separately. See page 96.

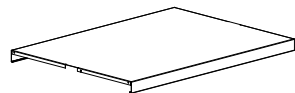

No. of bays	Frontedge cm	Module cm	Shelf depth cm	Item no.	Price EUR
1	47	75	22.5	B301046717147	172,37
1	47	75	25	B301046727147	178,89
1	47	75	30	B301046737147	187,80
1	47	75	40	B301046747147	205,35
1	47	90	22.5	B301046917147	181,55
1	47	90	25	B301046927147	188,46
1	47	90	30	B301046937147	194,18
1	47	90	40	B301046947147	224,37
1	47	100	22.5	B301046117147	199,90
1	47	100	25	B301046127147	201,76
1	47	100	30	B301046137147	211,87
1	47	100	40	B301046147147	236,87

Double-sided steel top shelf without brackets - for 2 intermediate bays

2 double and 2 middle brackets must be ordered separately. See page 96.

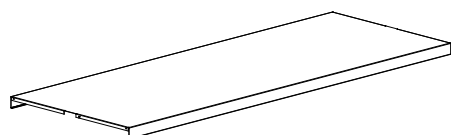

No. of bays	Frontedge cm	Module cm	Shelf depth cm	Item no.	Price EUR
2	47	75	22.5	B301046717247	303,37
2	47	75	25	B301046727247	314,81
2	47	75	30	B301046737247	330,64
2	47	75	40	B301046747247	361,36
2	47	90	22.5	B301046917247	319,60
2	47	90	25	B301046927247	331,57
2	47	90	30	B301046937247	341,68
2	47	90	40	B301046947247	394,88
2	47	100	22.5	B301046117247	351,79
2	47	100	25	B301046127247	355,11
2	47	100	30	B301046137247	372,80
2	47	100	40	B301046147247	416,96

SHELVES

BRACKETS FOR STEEL TOP SHELVES

Steel bracket for steel top shelf B301046 and B301049

Max. load of 25 kg.

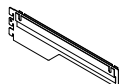
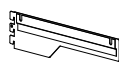
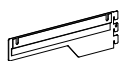

Type	Shelf depth cm	Item no.	Price EUR
Left	22.5	B30102917	14,76
Left	25	B30102927	15,16
Left	30	B30102937	15,30
Left	40	B30102947	16,89
Right	22.5	B30102918	14,76
Right	25	B30102928	15,16
Right	30	B30102938	15,30
Right	40	B30102948	16,89
Double	22.5	B30102919	15,30
Double	25	B30102929	16,09
Double	30	B30102939	16,36
Double	40	B30102949	18,22

Steel middle bracket for steel top shelf B301046 and B301049 over 2 bays

Max. load of 25 kg.



Frontedge cm	Shelf depth cm	Item no.	Price EUR
25	22.5	B301047125	17,02
25	25	B301047225	17,02
25	30	B301047325	17,02
25	40	B301047425	17,02
47	22.5	B301047147	17,02
47	25	B301047247	17,02
47	30	B301047347	17,02
47	40	B301047447	17,02



SHELVES

SINGLE-SIDED LONDON STEEL OVERLAYING TOP PLATE - 30 MM FRONTEDGE

Single-sided London steel overlaying top plate - freestanding

30 mm front edge. Incl. brackets.	Module cm	Shelf depth cm	Bays	Art. no.	Price EUR
	75	22.5	1	B301628711019	115,71
	75	25	1	B301628721019	121,83
	75	30	1	B301628731019	135,39
	75	40	1	B301628741019	181,01
	90	22.5	1	B301628911019	136,59
	90	25	1	B301628921019	143,77
	90	30	1	B301628931019	162,26
	90	40	1	B301628941019	208,94
	100	22.5	1	B301628111019	174,50
	100	25	1	B301628121019	183,67
	100	30	1	B301628131019	207,35
	100	40	1	B301628141019	266,93
	75	22.5	2	B301628711029	227,30
	75	25	2	B301628721029	239,27
	75	30	2	B301628731029	263,34
	75	40	2	B301628741029	341,41
	90	22.5	2	B301628911029	265,47
	90	25	2	B301628921029	278,90
	90	30	2	B301628931029	311,75
	90	40	2	B301628941029	408,58
	100	22.5	2	B301628111029	339,15
	100	25	2	B301628121029	356,44
	100	30	2	B301628131029	398,34
	100	40	2	B301628141029	522,03

Single-sided London steel overlaying top plate - outer

30 mm front edge. Incl. brackets.	Module cm	Shelf depth cm	Bays	Art. no.	Price EUR
	75	22.5	1	B301628711017	121,16
	75	25	1	B301628721017	127,55
	75	30	1	B301628731017	142,18
	75	40	1	B301628741017	181,01
	90	22.5	1	B301628911017	142,18
	90	25	1	B301628921017	149,49
	90	30	1	B301628931017	162,26
	90	40	1	B301628941017	208,94
	100	22.5	1	B301628111017	181,68
	100	25	1	B301628121017	190,99
	100	30	1	B301628131017	207,35
	100	40	1	B301628141017	266,93
	75	22.5	2	B301628711027	226,37
	75	25	2	B301628721027	238,34
	75	30	2	B301628731027	262,14
	75	40	2	B301628741027	345,14
	90	22.5	2	B301628911027	265,20
	90	25	2	B301628921027	278,77
	90	30	2	B301628931027	315,34
	90	40	2	B301628941027	408,58
	100	22.5	2	B301628111027	338,88
	100	25	2	B301628121027	356,17
	100	30	2	B301628131027	402,99
	100	40	2	B301628141027	522,03

SHELVES

SINGLE-SIDED LONDON STEEL OVERLAYING TOP PLATE - 30 MM FRONTEDGE

Single-sided London steel overlaying top plate - intermediate

30 mm front edge. Incl. brackets.	Module cm	Shelf depth cm	Bays	Art. no.	Price EUR
	75	22.5	1	B301628711018	115,98
	75	25	1	B301628721018	121,96
	75	30	1	B301628731018	135,39
	75	40	1	B301628741018	173,30
	90	22.5	1	B301628911018	136,59
	90	25	1	B301628921018	143,77
	90	30	1	B301628931018	158,14
	90	40	1	B301628941018	201,23
	100	22.5	1	B301628111018	174,50
	100	25	1	B301628121018	183,67
	100	30	1	B301628131018	202,03
	100	40	1	B301628141018	257,09
	75	22.5	2	B301628711028	222,38
	75	25	2	B301628721028	234,21
	75	30	2	B301628731028	263,21
	75	40	2	B301628741028	336,89
	90	22.5	2	B301628911028	263,87
	90	25	2	B301628921028	277,84
	90	30	2	B301628931028	307,23
	90	40	2	B301628941028	400,20
	100	22.5	2	B301628111028	337,16
	100	25	2	B301628121028	354,98
	100	30	2	B301628131028	392,62
	100	40	2	B301628141028	511,39

SHELVES

DOUBLE-SIDED LONDON STEEL OVERLAYING TOP PLATE - 30 MM FRONTEDGE

Double-sided London steel overlaying top plate - freestanding

30 mm front edge. Incl. brackets.	Module cm	Shelf depth cm	Bays	Art. no.	Price EUR
	75	22.5	1	B301628712019	203,36
	75	25	1	B301628722019	214,13
	75	30	1	B301628732019	242,06
	75	40	1	B301628742019	328,78
	90	22.5	1	B301628912019	242,06
	90	25	1	B301628922019	254,83
	90	30	1	B301628932019	281,83
	90	40	1	B301628942019	381,05
	100	22.5	1	B301628112019	309,36
	100	25	1	B301628122019	325,58
	100	30	1	B301628132019	360,16
	100	40	1	B301628142019	486,91
	75	22.5	2	B301628712029	394,74
	75	25	2	B301628722029	415,49
	75	30	2	B301628732029	466,70
	75	40	2	B301628742029	629,22
	90	22.5	2	B301628912029	467,63
	90	25	2	B301628922029	492,23
	90	30	2	B301628932029	557,27
	90	40	2	B301628942029	750,79
	100	22.5	2	B301628112029	597,57
	100	25	2	B301628122029	628,96
	100	30	2	B301628132029	712,08
	100	40	2	B301628142029	959,33

Double-sided London steel overlaying top plate - outer

30 mm front edge. Incl. brackets.	Module cm	Shelf depth cm	Bays	Art. no.	Price EUR
	75	22.5	1	B301628712017	203,36
	75	25	1	B301628722017	214,13
	75	30	1	B301628732017	247,11
	75	40	1	B301628742017	325,32
	90	22.5	1	B301628912017	242,06
	90	25	1	B301628922017	254,83
	90	30	1	B301628932017	281,83
	90	40	1	B301628942017	376,79
	100	22.5	1	B301628112017	309,36
	100	25	1	B301628122017	325,58
	100	30	1	B301628132017	360,16
	100	40	1	B301628142017	481,46
	75	22.5	2	B301628712027	394,74
	75	25	2	B301628722027	415,49
	75	30	2	B301628732027	475,74
	75	40	2	B301628742027	629,36
	90	22.5	2	B301628912027	458,85
	90	25	2	B301628922027	483,46
	90	30	2	B301628932027	557,27
	90	40	2	B301628942027	732,96
	100	22.5	2	B301628112027	586,26
	100	25	2	B301628122027	617,79
	100	30	2	B301628132027	712,08
	100	40	2	B301628142027	936,59

SHELVES

DOUBLE-SIDED LONDON STEEL OVERLAYING TOP PLATE - 30 MM FRONTEDGE

Double-sided London steel overlaying top plate - intermediate

30 mm front edge. Incl. brackets.	Module cm	Shelf depth cm	Bays	Art. no.	Price EUR
	75	22.5	1	B301628712018	203,76
	75	25	1	B301628722018	214,40
	75	30	1	B301628732018	242,33
	75	40	1	B301628742018	321,33
	90	22.5	1	B301628912018	242,06
	90	25	1	B301628922018	254,83
	90	30	1	B301628932018	285,02
	90	40	1	B301628942018	373,07
	100	22.5	1	B301628112018	309,36
	100	25	1	B301628122018	325,58
	100	30	1	B301628132018	364,15
	100	40	1	B301628142018	476,67
	75	22.5	2	B301628712028	395,01
	75	25	2	B301628722028	415,89
	75	30	2	B301628732028	467,10
	75	40	2	B301628742028	625,63
	90	22.5	2	B301628912028	458,85
	90	25	2	B301628922028	483,46
	90	30	2	B301628932028	546,36
	90	40	2	B301628942028	729,11
	100	22.5	2	B301628112028	586,26
	100	25	2	B301628122028	617,79
	100	30	2	B301628132028	698,12
	100	40	2	B301628142028	931,67

SHELVES

WOODEN SHELVES

See below for overview of standard wooden shelves:

B401020 - WOODEN SHELF WITH STEEL BACKEDGE

Details:

- Module 750/900 mm
- Depth 225/250/300/400 mm
- Steel backedge H47 mm
- Backedge book support
- Steel plate brackets
- Max. weight 80 kg.
- Straight
- Use with steel top shelf B401003, B401011, B301049, B301049 and wooden top shelf B401020

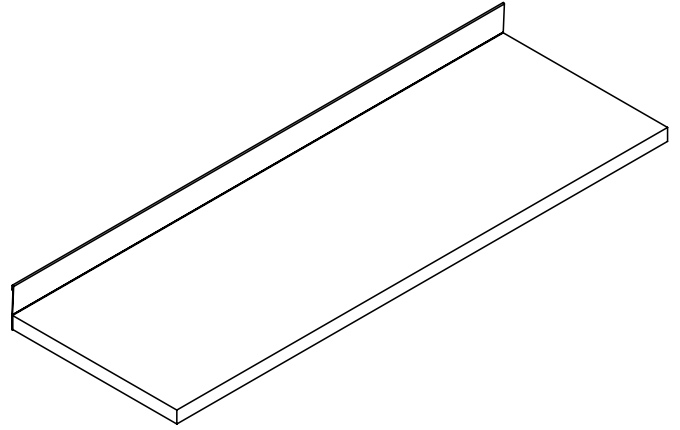

SHELVES

WOODEN SHELVES

Wooden shelf with steel backedge and without brackets - for backedge book support

Brackets must be ordered separately.
See below.

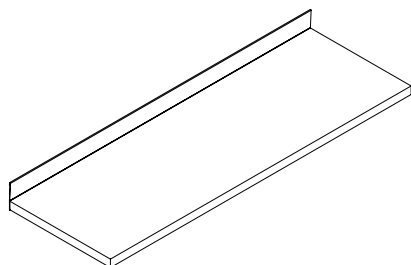

Module cm	Shelf depth cm	Item no. Painted	Price EUR	Item no. Veneer	Price EUR
75	22.5	B4010201175	99,75	B4010201171	139,65
75	25	B4010201275	99,75	B4010201271	139,65
75	30	B4010201375	99,75	B4010201371	139,65
75	40	B4010201475	120,63	B4010201471	168,91
90	22.5	B4010201195	99,75	B4010201191	139,65
90	25	B4010201295	99,75	B4010201291	139,65
90	30	B4010201395	99,75	B4010201391	139,65
90	40	B4010201495	120,63	B4010201491	168,91

Steel plate bracket for wooden shelf

H15 cm. For both starter and add-on bays, one left bracket and one right bracket are needed.

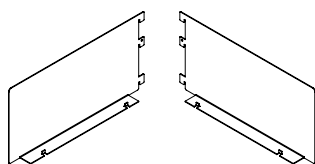

Type	Shelf depth cm	Item no.	Price EUR
Left	22.5	B30110618	21,68
Left	25	B30110628	22,08
Left	30	B30110638	23,14
Left	40	B30110648	24,07
Right	22.5	B30110619	21,68
Right	25	B30110629	22,08
Right	30	B30110639	23,14
Right	40	B30110649	24,07

SHELVES

WOODEN TOP SHELVES AND LONDON OVERLAYING TOP PLATE

See below for overview of standard wooden top shelves and overlaying top plate:

B401020 - SINGLE-SIDED WOODEN TOP SHELF

Details:

- Module 750/900/1000 mm
- Depth 225/250/300/400 mm
- Steel brackets
- Max. weight 25 kg.

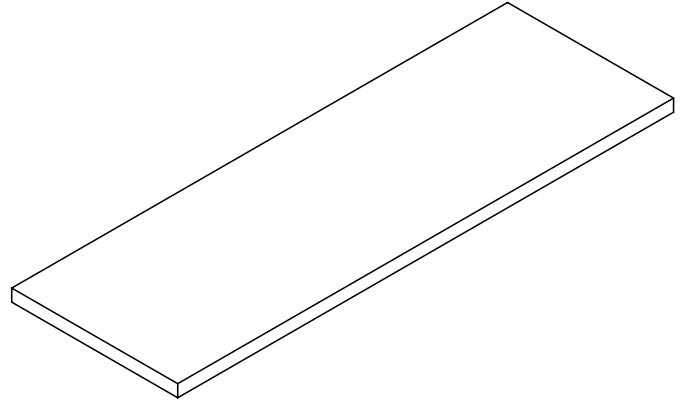

B302130 - FSC SINGLE- & DOUBLE-SIDED LONDON WOODEN OVERLAYING TOP PLATE

Details:

- Module 750/900/1000 mm
- Depth 225/250/300/400 mm
- Freestanding/outer/intermediate
- Steel brackets
- Max. weight 25 kg.
- 1/2/3 bays

SHELVES

WOODEN TOP SHELVES - FOR BACKEDGE BOOK SUPPORT

Wooden top shelf without brackets - to be used with steel shelves for backedge book support

Brackets must be ordered separately.
See below.

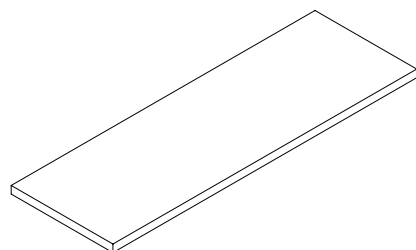

Module cm	Shelf depth cm	Item no. Painted	Price EUR	Item no. Veneer	Price EUR
75	22.5	B4010200175	112,78	B4010200171	157,87
75	25	B4010200275	112,78	B4010200271	157,87
75	30	B4010200375	112,78	B4010200371	157,87
75	40	B4010200475	117,97	B4010200471	165,05
90	22.5	B4010200195	112,78	B4010200191	157,87
90	25	B4010200295	112,78	B4010200291	157,87
90	30	B4010200395	112,78	B4010200391	157,87
90	40	B4010200495	117,97	B4010200491	165,05
100	22.5	B4010200115	125,55	B4010200111	175,83
100	25	B4010200215	125,55	B4010200211	175,83
100	30	B4010200315	125,55	B4010200311	175,83
100	40	B4010200415	131,14	B4010200411	183,54

Steel bracket for wooden top shelf

H7.5 cm. For both starter and add-on bays, one left bracket and one right bracket are needed.

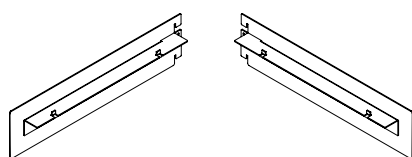

Type	Shelf depth cm	Item no.	Price EUR
Left	22.5	B30110018	18,75
Left	25	B30110028	21,15
Left	30	B30110038	21,15
Left	40	B30110048	27,93
Right	22.5	B30110019	18,75
Right	25	B30110029	21,15
Right	30	B30110039	21,15
Right	40	B30110049	27,93

SHELVES

SINGLE-SIDED LONDON WOODEN OVERLAYING TOP PLATES - FREESTANDING - WITH BRACKETS

Single-sided FSC London wooden overlaying top plate - freestanding

30 mm front edge. Incl. brackets.

Module cm	Shelf depth cm	Bays	Art. no.	Price EUR
75	22.5	1	B302136171019	115,98
75	25	1	B302136271019	121,96
75	30	1	B302136371019	136,06
75	40	1	B302136471019	181,68
90	22.5	1	B302136191019	137,52
90	25	1	B302136291019	144,97
90	30	1	B302136391019	163,32
90	40	1	B302136491019	210,27
100	22.5	1	B302136111019	146,43
100	25	1	B302136211019	154,15
100	30	1	B302136311019	175,83
100	40	1	B302136411019	225,83
75	22.5	2	B302136171029	227,83
75	25	2	B302136271029	239,80
75	30	2	B302136371029	264,01
75	40	2	B302136471029	342,87
90	22.5	2	B302136191029	266,27
90	25	2	B302136291029	280,36
90	30	2	B302136391029	313,22
90	40	2	B302136491029	410,17
100	22.5	2	B302136111029	283,96
100	25	2	B302136211029	299,25
100	30	2	B302136311029	339,02
100	40	2	B302136411029	442,49
75	22.5	3	B302136171039	326,78
75	25	3	B302136271039	343,67
75	30	3	B302136371039	385,83
75	40	3	B302136471039	507,40
90	22.5	3	B302136191039	391,42
90	25	3	B302136291039	412,03
90	30	3	B302136391039	463,37
90	40	3	B302136491039	608,34

SHELVES

SINGLE-SIDED LONDON WOODEN OVERLAYING TOP PLATES - OUTER - WITH BRACKETS

Single-sided FSC London wooden overlaying top plate - outer

30 mm front edge. Incl. brackets.

Module cm	Shelf depth cm	Bays	Art. no.	Price EUR
75	22.5	1	B302136171017	121,96
75	25	1	B302136271017	128,48
75	30	1	B302136371017	142,44
75	40	1	B302136471017	181,81
90	22.5	1	B302136191017	142,58
90	25	1	B302136291017	150,16
90	30	1	B302136391017	163,32
90	40	1	B302136491017	210,27
100	22.5	1	B302136111017	150,02
100	25	1	B302136211017	158,00
100	30	1	B302136311017	179,55
100	40	1	B302136411017	229,96
75	22.5	2	B302136171027	227,30
75	25	2	B302136271027	239,40
75	30	2	B302136371027	262,94
75	40	2	B302136471027	346,73
90	22.5	2	B302136191027	266,27
90	25	2	B302136291027	280,36
90	30	2	B302136391027	316,94
90	40	2	B302136491027	410,17
100	22.5	2	B302136111027	288,21
100	25	2	B302136211027	303,51
100	30	2	B302136311027	346,86
100	40	2	B302136411027	442,62
75	22.5	3	B302136171037	337,55
75	25	3	B302136271037	355,11
75	30	3	B302136371037	390,09
75	40	3	B302136471037	511,12
90	22.5	3	B302136191037	395,41
90	25	3	B302136291037	416,16
90	30	3	B302136391037	466,43
90	40	3	B302136491037	607,01

SHELVES

SINGLE-SIDED LONDON WOODEN OVERLAYING TOP PLATES - INTERMEDIATE - WITH BRACKETS

Single-sided FSC London wooden overlaying top plate - intermediate

30 mm front edge. Incl. brackets.

Module cm	Shelf depth cm	Bays	Art. no.	Price EUR
75	22.5	1	B302136171018	116,24
75	25	1	B302136271018	122,23
75	30	1	B302136371018	136,19
75	40	1	B302136471018	173,83
90	22.5	1	B302136191018	136,99
90	25	1	B302136291018	144,17
90	30	1	B302136391018	158,94
90	40	1	B302136491018	201,76
100	22.5	1	B302136111018	149,36
100	25	1	B302136211018	157,21
100	30	1	B302136311018	172,24
100	40	1	B302136411018	221,71
75	22.5	2	B302136171028	222,91
75	25	2	B302136271028	234,48
75	30	2	B302136371028	264,01
75	40	2	B302136471028	338,49
90	22.5	2	B302136191028	264,94
90	25	2	B302136291028	278,77
90	30	2	B302136391028	308,96
90	40	2	B302136491028	401,79
100	22.5	2	B302136111028	283,96
100	25	2	B302136211028	299,25
100	30	2	B302136311028	334,50
100	40	2	B302136411028	434,38
75	22.5	3	B302136171038	326,91
75	25	3	B302136271038	343,81
75	30	3	B302136371038	393,28
75	40	3	B302136471038	502,87
90	22.5	3	B302136191038	391,42
90	25	3	B302136291038	412,03
90	30	3	B302136391038	466,43
90	40	3	B302136491038	602,22

SHELVES

DOUBLE-SIDED LONDON WOODEN OVERLAYING TOP PLATES - FREESTANDING - WITH BRACKETS

Double-sided FSC London wooden overlaying top plate - freestanding

30 mm front edge. Incl. brackets.	Module cm	Shelf depth cm	Bays	Art. no.	Price EUR
	75	22.5	1	B302136172019	204,16
	75	25	1	B302136272019	215,46
	75	30	1	B302136372019	243,12
	75	40	1	B302136472019	330,24
	90	22.5	1	B302136192019	243,12
	90	25	1	B302136292019	255,76
	90	30	1	B302136392019	283,02
	90	40	1	B302136492019	382,24
	100	22.5	1	B302136112019	261,48
	100	25	1	B302136212019	275,18
	100	30	1	B302136312019	324,12
	100	40	1	B302136412019	418,15
	75	22.5	2	B302136172029	396,34
	75	25	2	B302136272029	417,35
	75	30	2	B302136372029	468,69
	75	40	2	B302136472029	632,15
	90	22.5	2	B302136192029	469,62
	90	25	2	B302136292029	494,63
	90	30	2	B302136392029	559,66
	90	40	2	B302136492029	754,11
	100	22.5	2	B302136112029	506,46
	100	25	2	B302136212029	532,93
	100	30	2	B302136312029	621,11
	100	40	2	B302136412029	812,10
	75	22.5	3	B302136172039	584,54
	75	25	3	B302136272039	615,26
	75	30	3	B302136372039	702,77
	75	40	3	B302136472039	937,65
	90	22.5	3	B302136192039	696,65
	90	25	3	B302136292039	733,23
	90	30	3	B302136392039	830,85
	90	40	3	B302136492039	1.118,53

SHELVES

DOUBLE-SIDED LONDON WOODEN OVERLAYING TOP PLATES - OUTER - WITH BRACKETS

Double-sided FSC London wooden overlaying top plate - outer

30 mm front edge. Incl. brackets.

Module cm	Shelf depth cm	Bays	Art. no.	Price EUR
75	22.5	1	B302136172017	204,82
75	25	1	B302136272017	215,59
75	30	1	B302136372017	247,78
75	40	1	B302136472017	326,78
90	22.5	1	B302136192017	243,12
90	25	1	B302136292017	255,76
90	30	1	B302136392017	283,16
90	40	1	B302136492017	378,78
100	22.5	1	B302136112017	261,48
100	25	1	B302136212017	275,18
100	30	1	B302136312017	310,95
100	40	1	B302136412017	414,83
75	22.5	2	B302136172027	396,34
75	25	2	B302136272027	417,35
75	30	2	B302136372027	478,27
75	40	2	B302136472027	632,42
90	22.5	2	B302136192027	461,24
90	25	2	B302136292027	485,32
90	30	2	B302136392027	559,66
90	40	2	B302136492027	736,02
100	22.5	2	B302136112027	506,46
100	25	2	B302136212027	532,93
100	30	2	B302136312027	604,75
100	40	2	B302136412027	808,11
75	22.5	3	B302136172037	584,54
75	25	3	B302136272037	615,26
75	30	3	B302136372037	695,46
75	40	3	B302136472037	933,53
90	22.5	3	B302136192037	696,65
90	25	3	B302136292037	733,23
90	30	3	B302136392037	830,85
90	40	3	B302136492037	1.093,39

SHELVES

DOUBLE-SIDED LONDON WOODEN OVERLAYING TOP PLATES - INTERMEDIATE - WITH BRACKETS

Double-sided FSC London wooden overlaying top plate - intermediate

30 mm front edge. Incl. brackets.	Module cm	Shelf depth cm	Bays	Art. no.	Price EUR
	75	22.5	1	B302136172018	205,09
	75	25	1	B302136272018	215,86
	75	30	1	B302136372018	243,26
	75	40	1	B302136472018	322,53
	90	22.5	1	B302136192018	243,12
	90	25	1	B302136292018	255,76
	90	30	1	B302136392018	286,08
	90	40	1	B302136492018	374,93
	100	22.5	1	B302136112018	261,74
	100	25	1	B302136212018	275,44
	100	30	1	B302136312018	311,22
	100	40	1	B302136412018	410,70
	75	22.5	2	B302136172028	396,74
	75	25	2	B302136272028	417,49
	75	30	2	B302136372028	469,36
	75	40	2	B302136472028	627,89
	90	22.5	2	B302136192028	461,38
	90	25	2	B302136292028	485,45
	90	30	2	B302136392028	549,16
	90	40	2	B302136492028	732,03
	100	22.5	2	B302136112028	506,46
	100	25	2	B302136212028	533,33
	100	30	2	B302136312028	604,88
	100	40	2	B302136412028	812,10
	75	22.5	3	B302136172038	584,67
	75	25	3	B302136272038	615,39
	75	30	3	B302136372038	695,59
	75	40	3	B302136472038	933,79
	90	22.5	3	B302136192038	696,65
	90	25	3	B302136292038	733,23
	90	30	3	B302136392038	815,02
	90	40	3	B302136492038	1.089,94

SHELVES

BRACKETS FOR LONDON WOODEN TOP PLATES

Steel top bracket for London wooden top plate

When sold separately, it is necessary to order two screws per bracket, item no. 1147024016.

Shelf depth cm
22.5
25
30
40

Item no. Left	Price EUR	Item no. Right	Price EUR
B30120018	13,03	B30120019	13,03
B30120028	13,97	B30120029	13,97
B30120038	13,97	B30120039	13,97
B30120048	13,97	B30120049	13,97

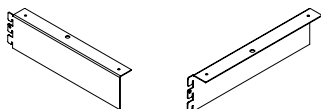

SHELVES

ACCESSOIRES

Reinforcement for shelf

All depths	Module cm	Item no.	Price EUR
	75	B3020407	16,36
	90	B3020409	17,56
	100	B3020401	18,62

Acrylic backedge

For shelf BB40077xxxxx and B401013xx.
H6 cm.

Module cm	Item no.	Price EUR
75	B4010127	-
90	B4010129	-
100	B4010121	-

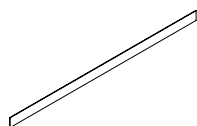

Shelf bridge for shelf without backedge for 60/30 & 80/30 Classic upright

Used to minimize gap between top shelves without steel backedge and without sign profile on double-sided shelving. W6 cm for 60/30, W8 cm for 80/30.

Module cm	Width cm	Item no.	Price EUR
75	6	B3020307	20,22
90	6	B3020309	20,62
100	6	B3020301	22,34
75	8	B3020357	20,22
90	8	B3020359	20,62
100	8	B3020351	22,34

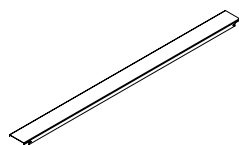



ACCESSORIES

BOOK SUPPORTS

Backedge book support for straight shelves with steel backedge

Nickel plated steel, Ø6 mm, with a nylon glider. For shelf BB40076xxxxx and B401001xx.

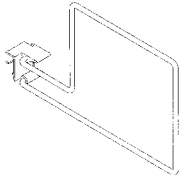

Height cm	Shelf depth cm	Type	Item no.	Price EUR
16,3	22.5/25	For books on left side of book support	B4011221	16,89
16,3	30	For books on left side of book support	B4011222	18,22
24,3	25/30	For books on left side of book support	B4011223	23,67
16,3	22.5/25	For books on right side of book support	B4011224	16,89
16,3	30	For books on right side of book support	B4011225	18,22

Hanging book support for shelves with acrylic backedge

Available in chromed steel or BCI standard steel colours. For shelf BB40077xxxxx and B401013xx



Height cm	Item no.	Price EUR
20	B4011242	9,04
25	B4011245	9,71

Rail for hanging book support for wooden shelves

Incl. fittings.

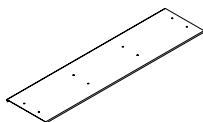

Width cm	Shelf depth cm	Item no.	Price EUR
75	25, 30, 40	B4022007	32,45
90	25, 30, 40	B4022009	32,45

Angled book support

W15 x H15 x D15 cm.

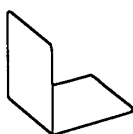

Item no.	Price EUR
B401120	10,37

ACCESSORIES

BROWSERS

Single steel browser - one level - without/with pull-out frame

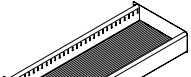
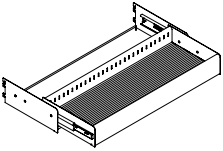
W75 cm. Incl. fittings and rubber mat. Excl. tubes	Height cm	Depth cm	No. of dividers	Item no.	Price	Item no.	Price
				Without pull-out function	EUR	With pull-out function	EUR
 	10	30 ^{*1}	0	B3052007100	257,36	B3052027500	468,29
	10	30	1	B3052007101	272,25	B3052027501	483,46
	10	30	2	B3052007102	287,28	B3052027502	498,35
	10	30	4	B3052007104	316,67	B3052027504	528,28

Single steel browser - one level - without/with pull-out frame

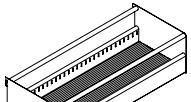
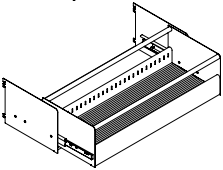
W75 cm. Incl. fittings, rubber mat and tubes.	Height cm	Depth cm	No. of dividers	Item no.	Price	Item no.	Price
				Without pull-out function	EUR	With pull-out function	EUR
 	20	30 ^{*2}	0	B3052007200	334,10	B3052027600	545,43
	20	30	1	B3052007201	348,86	B3052027601	560,06
	20	30	2	B3052007202	363,76	B3052027602	574,83
	20	30	4	B3052007204	393,41	B3052027604	604,22

Single steel browser - one level - without/with pull-out frame

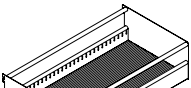
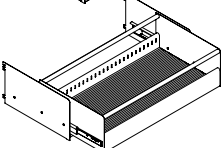
W75 cm. Incl. fittings, rubber mat and tubes.	Height cm	Depth cm	No. of dividers	Item no.	Price	Item no.	Price
				Without pull-out function	EUR	With pull-out function	EUR
 	20	40 ^{*3}	0	B3052007300	350,72	B3052027700	561,66
	20	40	1	B3052007301	368,14	B3052027701	578,82
	20	40	2	B3052007302	385,17	B3052027702	596,11
	20	40	4	B3052007304	419,62	B3052027704	630,69

Double steel browser - two levels - without/with pull-out frame

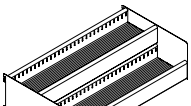
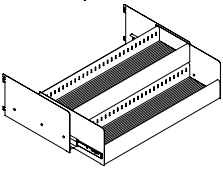
W75 cm. Incl. fittings and rubber mat. Excl. tubes	Height cm	Depth cm	No. of dividers	Item no.	Price	Item no.	Price
				Without pull-out function	EUR	With pull-out function	EUR
 	20	40 ^{*4}	0	B3052007400	463,51	B3052027800	674,31
	20	40	2	B3052007402	486,65	B3052027802	697,98
	20	40	4	B3052007404	511,52	B3052027804	722,06
	20	40	8	B3052007408	559,53	B3052027808	770,60

ACCESSORIES

BROWSERS

Single steel browser - one level - without/with pull-out frame

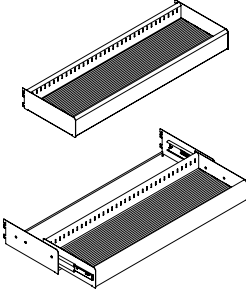
W90 cm. Incl. fittings and rubber mat. Excl. tubes	Height cm	Depth cm	No. of dividers	Item no. Without pull-out function	Price EUR	Item no. With pull-out function	Price EUR
	10	30 *1	0	B3052009100	257,36	B3052029500	468,29
	10	30	2	B3052009101	272,25	B3052029501	483,46
	10	30	4	B3052009102	287,28	B3052029502	498,35
	10	30	5	B3052009104	316,67	B3052029504	528,28

Single steel browser - one level - without/with pull-out frame

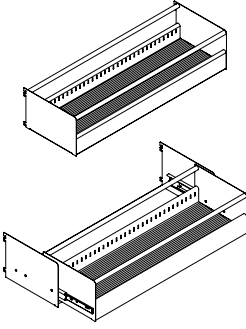
W90 cm. Incl. fittings, rubber mat and tubes.	Height cm	Depth cm	No. of dividers	Item no. Without pull-out function	Price EUR	Item no. With pull-out function	Price EUR
	20	30 *2	0	B3052009200	334,10	B3052029600	545,43
	20	30	2	B3052009201	348,86	B3052029601	560,06
	20	30	4	B3052009202	363,76	B3052029602	574,83
	20	30	5	B3052009204	393,41	B3052029604	604,22

Single steel browser - one level - without/with pull-out frame

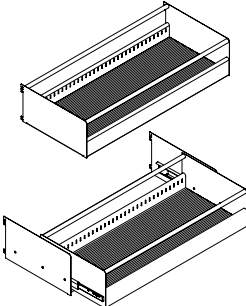
W90 cm. Incl. fittings, rubber mat and tubes.	Height cm	Depth cm	No. of dividers	Item no. Without pull-out function	Price EUR	Item no. With pull-out function	Price EUR
	20	40 *3	0	B3052009300	350,72	B3052029700	561,66
	20	40	2	B3052009301	368,14	B3052029701	578,82
	20	40	4	B3052009302	385,17	B3052029702	596,11
	20	40	5	B3052009304	419,62	B3052029704	630,69

Double steel browser - two levels - without/with pull-out frame

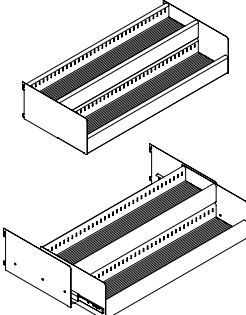
W90 cm. Incl. fittings and rubber mat. Excl. tubes	Height cm	Depth cm	No. of dividers	Item no. Without pull-out function	Price EUR	Item no. With pull-out function	Price EUR
	20	40 *4	0	B3052009400	463,51	B3052029800	674,31
	20	40	4	B3052009402	486,65	B3052029802	697,98
	20	40	8	B3052009404	511,52	B3052029804	722,06
	20	40	10	B3052009408	559,53	B3052029808	770,60



WE
ARE
LIBRARY
PEOPLE®



ACCESSORIES

BROWSERS

Dividers for single and double steel browser

Chromed steel.

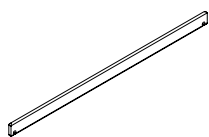

Level	Height cm	Depth cm	Item no.	Price EUR
One	10	30	B4011603	15,16
One	20	30	B4011603	15,16
One	20	40	B4011604	17,56
Two	20	40	B4011601	12,24

Capacity examples for 75 cm single/double steel browser without pullout (see page 116)

	Type	W cm	H x D cm	CD cases	DVD cases	CD pockets	Picture books	Comic picture books
				5 rows	5 rows	5 rows	3 rows	2 rows
*1	Single	75	10 x 30	100	75	325	-	-
*2	Single	75	20 x 30	100	75	325	90	40
*3	Single	75	20 x 40	150	105	325	120	50
				2 x 5 rows	2 x 5 rows	2 x 5 rows	3 rows	2 rows
*4	Double	75	20 x 40	130	95	400	-	-

Capacity examples for 75 cm single/double steel browser with pullout (see page 116)

	Type	W cm	H x D cm	CD cases	DVD cases	CD pockets	Picture books	Comic picture books
				5 rows	5 rows	5 rows	3 rows	2 rows
*1	Single	75 cm	10 x 30	80	60	260	-	-
*2	Single	75 cm	20 x 30	80	60	260	90	40
*3	Single	75 cm	20 x 40	120	84	340	120	50
				2 x 5 rows	2 x 5 rows	2 x 5 rows	3 rows	2 rows
*4	Double	75 cm	20 x 40	104	76	320	-	-

Capacity examples for 90 cm single/double steel browser without pullout (see page 117)

	Type	W cm	H x D cm	CD cases	DVD cases	CD pockets	Picture books	Comic picture books
				6 rows	6 rows	6 rows	4 rows	3 rows
*1	Single	90 cm	10 x 30	120	90	390	-	-
*2	Single	90 cm	20 x 30	120	90	390	120	60
*3	Single	90 cm	20 x 40	180	126	510	180	75
				2 x 6 rows	2 x 6 rows	2 x 6 rows	4 rows	3 rows
*4	Double	90 cm	20 x 40	156	114	480	-	-

Capacity examples for 90 cm single/double steel browser with pullout (see page 117)

	Type	W cm	H x D cm	CD cases	DVD cases	CD pockets	Picture books	Comic picture books
				6 rows	6 rows	6 rows	4 rows	3 rows
*1	Single	90 cm	10 x 30	100	75	325	-	-
*2	Single	90 cm	20 x 30	100	75	325	120	60
*3	Single	90 cm	20 x 40	150	105	425	160	75
				2 x 6 rows	2 x 6 rows	2 x 6 rows	4 rows	3 rows
*4	Double	90 cm	20 x 40	130	95	400	-	-



TIDNINGAR



ACCESSORIES

DISPLAY & STORAGE - MAGAZINE

Magazine display - with 1 tip up sloping shelf

W90 x H40 x D40 cm. With space for storage of either magazines piled horizontally or vertical binders (up to 32 cm in height)

Item no.

Price
EUR

B305100

483,59

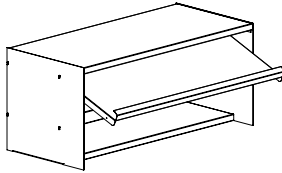

Magazine display - with 1 tip up sloping shelf and moveable dividers

W90 x H40 x D40 cm. With space for separate storage of either magazines piled horizontally or vertical binders (up to 32 cm in height). Dividers can be moved 5 cm either way.

Item no.

Price
EUR

B305110

567,91

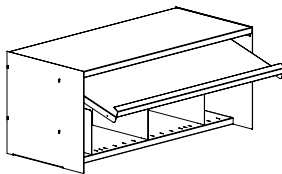

Magazine display - with 3 tip up sloping shelves

W90 x H40 x D40 cm. With space for separate storage of either magazines piled horizontally or vertical binders (up to 32 cm in height)

Item no.

Price
EUR

B305120

599,83

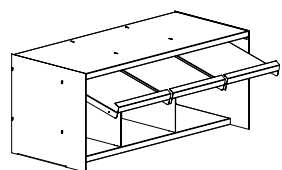



ACCESSORIES

DISPLAY & STORAGE - MAGAZINE

Steel magazine box - Unibox

H320 x D260 x W320 mm. Box and flap lacquered steel. With transparent antireflex foil. Recommended for use on D250 mm steel shelf with/without backedge and wooden shelf without backedge. Can be used on D300 mm shelves. With space for storage of magazines piled horizontally 140 mm.

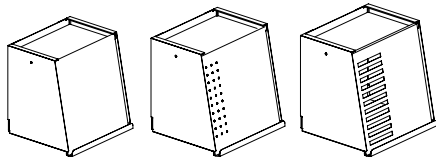

Design	Back wall	Item no.	Price EUR
-	Yes	B405502001	221,98
-	No	B405502000	202,43
With holes	Yes	B405502051	231,82
With holes	No	B405502050	212,53
With slots	Yes	B405502101	243,66
With slots	No	B405502100	224,24

Steel magazine box

H320 x D260 x W238 mm. Box and flap lacquered steel. Recommended for use on D250 mm steel shelf with/without backedge and wooden shelf without backedge. Can be used on D300 mm shelves. Upright storage of magazines. With space for storage of magazines piled vertically 140 mm.

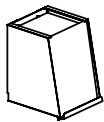

Item no.	Price EUR
B405504	248,84

Steel cabinet with sliding door

W90 x D40 cm. Incl. lock and 1 shelf.

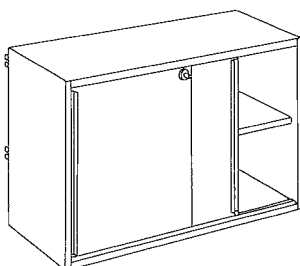

Height cm	Item no.	Price EUR
62.5	B3050306	1.025,70
80.0	B3050307	1.159,49



ACCESSORIES

DISPLAY & STORAGE - MULTIMEDIA

Steel pocket book shelf

W90 x H20 x D22.5 cm. Incl. fittings.
Capacity: 50-60 pcs.

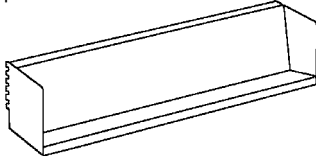

Item no.	Price EUR
B30515019	158,27

Steel shelf for CD's - 5 compartments (W17.8) with 4 steel dividers

W90 x H15 x D22.5 cm. Incl. fittings.
Capacity: 75 CD's

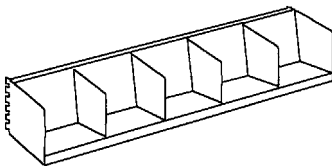

Item no.	Price EUR
B30513019	268,13

Steel shelf - 4 compartments (W22.4 cm) with 3 steel dividers

W90 x H20 cm. Incl. fittings.
Capacity: 75 picture books

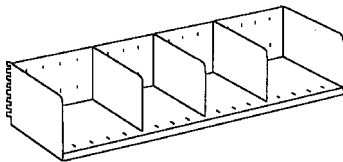

Depth
cm
22.5
30

Item no.	Price EUR
B3050411	183,41
B3050413	207,35

Extra steel dividers for steel shelf B305041x

H17.5 cm

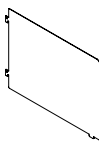

Depth
cm
22.5
30

Item no.	Price EUR
B4010401	18,62
B4010403	21,68

Steel shelf with 5 sliding dividers

W90 x H40 x D40 cm. Incl. fittings.
Can be used under browsers with
D40 cm on page 117. Capacity:
75 picture books/ 100 music
books.

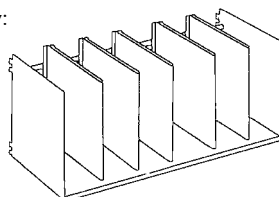

Item no.	Price EUR
B305080	582,94

FUNCTIONS

DISPLAY & STORAGE - FOR SHELVES

Steel magazine display

H300 mm. With slanted back and additional side stop. A double front edge keeps this collector flush with the front edge of the shelf. With slip stop to prevent the display from slipping on steel shelves.

Size	Width mm
DIN A4	220
DIN A3	440

Item no.	Price EUR
B4055064	46,15
B4055063	79,40

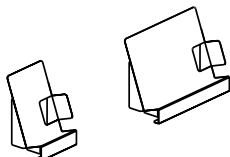

Steel magazine divider

H300 x W95 x D240 mm. Single, slanted element connectable side by side via plug-in connections. For bay W700 mm, use 6 dividers. For bay W900 mm, use 8 dividers. For bay W1000 mm, use 9 dividers.

Size
DIN A4

Item no.	Price EUR
B405508	40,30

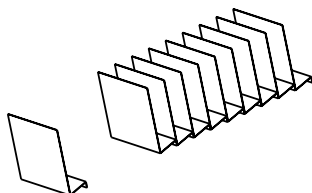

FUNCTIONS

DISPLAY & STORAGE - FOR SHELVES

Steel U-storage

H250 x W145 x D220 mm.
Multi-functional storage use.

Item no.

Price
EUR

B405510

55,20

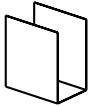

Steel slanted CD tray

H120 x W150 x D220 mm. With anti-slipping feet. Rubber mat to be ordered separately.

Approx. capacity

Item no.

Price
EUR

20 CD's
Rubber mat

B405536

73,02

B405538

9,44

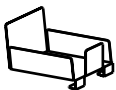

ACCESSORIES

DISPLAY & STORAGE - FOR WOODEN SLAT END PANEL

Acrylic media display holder

H100 x W600 x D40 mm.

Item no.

Price
EUR

E34466

-

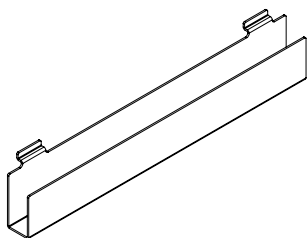

Acrylic brochure holder

H250 x W500 x D50 mm.

Item no.

Price
EUR

E34467

-

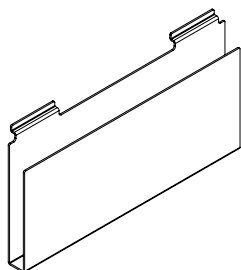

Acrylic sloping shelf display

H200 x W500 x D300 mm.

Item no.

Price
EUR

E34468

-

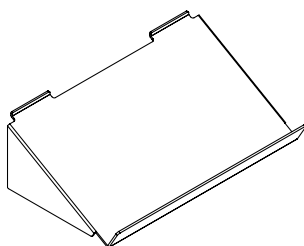

Acrylic tilted shelf display

H160 mm.

Width
mm

Depth
mm

Item no.

Price
EUR

75
220

90
95

E34469
E34470

-

-

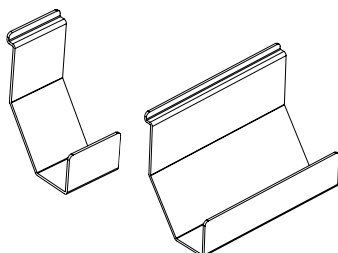

ACCESSORIES

DISPLAY & STORAGE - FOR PERFORATED STEEL END PANELS

Steel CD and paperback holder

The holder is a pair, so the width will vary. Bright galvanized steel.

Height mm	Max. insert size mm	Item no.	Price EUR
60	25	B4055221	13,97
140	25	B4055222	14,63

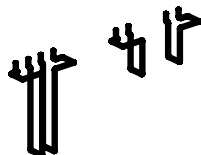

Steel book presenter

H148 x W90 mm. Chromed steel.

Size	Max. insert size mm	Item no.	Price EUR
A4	45	B405526	15,30



Steel hanging display

H200 x W90 mm. Chromed steel.

Size	Max. insert size mm	Item no.	Price EUR
A4	50	B405528	10,77





WE
ARE
LIBRARY
PEOPLE®



ACCESSORIES

SIGNAGE - FOR END PANEL/UPRIGHT/TOP

Steel sign for wooden end panel

Fastened to the end panel with screws.
The sign has an acrylic film for insertion
of textslide.

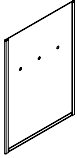

A4 vertical/upright format
A3 vertical/upright format
A3 horizontal format

Item no.

Price
EUR

B40110377	36,71
B40110378	48,94
B40110379	48,94

Steel sign for 60/30 Classic upright

For double-sided shelving. Fastened into
the slots of the upright.

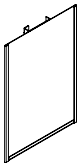

A4 vertical/upright format
A3 vertical/upright format
A4 horizontal format

Item no.

Price
EUR

B40110337	36,71
B40110338	48,94
B40110339	48,94

Laminated top sign for 60/30 Classic shelving bays

H150 x W870 mm (H290 mm when
mounted). Only for module 90 cm. To
be mounted in upper crossbar. Ideal
for 60/30 Expo. Laminat available in
white, black and grey.

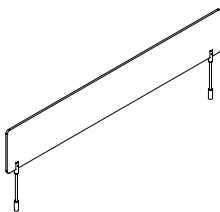

Item no.

Price
EUR

B3085039	303,77
----------	--------

ACCESSORIES

SIGNAGE - FOR SHELF

Steel sign for wooden top shelf and London wooden overlaying top plate

H4,5 cm. White label to be ordered separately.



Module
cm

75 Sign
90 Sign
100 Sign

100 Label

Item no.

B4010087
B4010087
B4010087

B40113002

Price
EUR

54,80
54,80
54,80

4,79

Magnetic shelf label - for steel top shelf with 47 mm frontedge

H40 mm. Black. Attach to steel shelves with smooth edge.

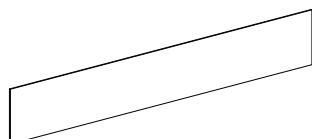

Width
mm

300

Item no.

B4000020300

Price
EUR

11,31

Plastic clip-on label holder - for steel shelf S1 with 25 mm frontedge

H25 mm. Incl. white label. Can glide along shelf.

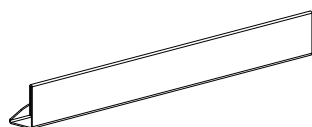

Width
mm

220

Item no.

B401135

Price
EUR

9,84

Plastic clip-on label holder - for steel shelf S2 with 25 mm frontedge

H25 mm. Incl. white label. Can glide along shelf.

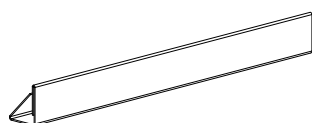

Width
mm

213

Item no.

E3881

Price
EUR

-

ACCESSORIES

SIGNAGE - FOR SHELF

Self-adhesive plastic label holder - for steel shelf S1/S2 with 25 mm frontedge

H20 mm. Transparent, antireflective plastic. Incl. white label.	Width mm		Item no.	Price EUR
	147		B4017124	1,46
	200		B4017125	2,13

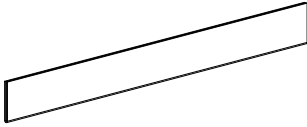

Magnetic plastic label holder - for steel shelf S1/S2 with 25 mm frontedge

H20 mm. Transparent, antireflective plastic. Incl. white label. Attach to steel shelves with smooth edge.	Width mm		Item no.	Price EUR
	210	Self-adhesive plastic label holder	B4017147	11,57
	209	White sheet w. 13 labels (spare part)	B4017116	0,93

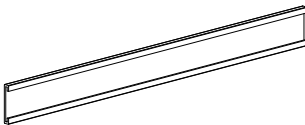

Steel label holder

H26 x W150 x D150 mm. Lacquered steel with transparent, antireflective plastic. Incl. white label. Universal use, simply place on shelf where needed.		Item no.	Price EUR
		B401801	11,57

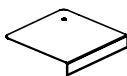

Labelling cube

H200 x D200 mm. Acrylic glass. Inscription field with transparent cover on sloping front. Incl. white cardboard label. Universal use, place in between books on shelf where needed.	Width mm		Item no.	Price EUR
	120		B40552011	94,96
	200		B40552031	100,42
	120		B4055211	1,06
	200		B4055213	1,06

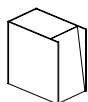

UPRIGHTS

60/30 CLASSIC UPRIGHTS

60/30 uprights - height 92 cm

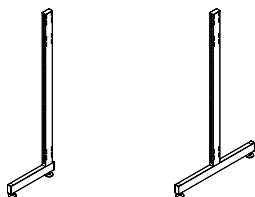

Shelf depth cm	Item no. Single-sided	Price EUR	Item no. Double-sided	Price EUR
22.5	B301000711	128,61	B301000712	140,32
25	B301000721	134,46	B301000722	144,04
30	B301000731	136,06	B301000732	149,63
40	B301000741	139,92	B301000742	155,61

60/30 Classic uprights - height 122 cm

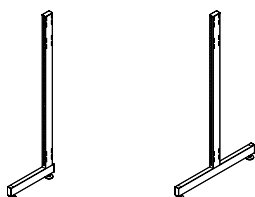

Shelf depth cm	Item no. Single-sided	Price EUR	Item no. Double-sided	Price EUR
22.5	B301000211	142,98	B301000212	156,14
25	B301000221	148,96	B301000222	160,40
30	B301000231	150,96	B301000232	166,65
40	B301000241	155,08	B301000242	172,37

60/30 Classic uprights - height 152 cm

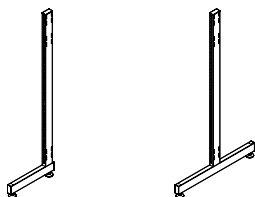

Shelf depth cm	Item no. Single-sided	Price EUR	Item no. Double-sided	Price EUR
22.5	B301000511	158,27	B301000512	174,50
25	B301000521	161,60	B301000522	178,35
30	B301000531	163,86	B301000532	182,34
40	B301000541	167,05	B301000542	192,19

60/30 Classic uprights - height 182 cm

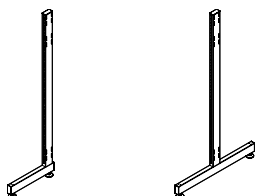

Shelf depth cm	Item no. Single-sided	Price EUR	Item no. Double-sided	Price EUR
22.5	B301000811	172,37	B301000812	182,34
25	B301000821	174,63	B301000822	190,46
30	B301000831	177,02	B301000832	195,78
40	B301000841	181,94	B301000842	205,22

60/30 Classic uprights - height 199.5 cm

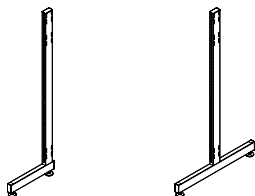

Shelf depth cm	Item no. Single-sided	Price EUR	Item no. Double-sided	Price EUR
22.5	B301000911	182,08	B301000912	198,57
25	B301000921	183,41	B301000922	202,29
30	B301000931	185,54	B301000932	205,22
40	B301000941	190,59	B301000942	213,60

60/30 Classic uprights - height 212 cm

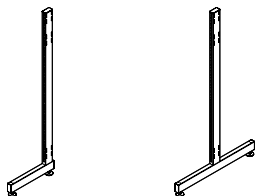

Shelf depth cm	Item no. Single-sided	Price EUR	Item no. Double-sided	Price EUR
22.5	B301000111	187,00	B301000112	
25	B301000121	190,06	B301000122	206,15
30	B301000131	192,58	B301000132	208,15
40	B301000141	196,31	B301000142	217,46

UPRIGHTS

80/30 CLASSIC UPRIGHTS

80/30 Classic uprights - height 199 cm

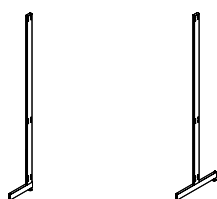

Shelf depth cm	Item no. Single-sided	Price EUR	Item no. Double-sided	Price EUR
22.5	B301060311	219,05	B301060312	241,66
25	B301060321	222,78	B301060322	257,89
30	B301060331	227,96	B301060332	254,43
40	B301060341	232,48	B301060342	272,25

80/30 Classic uprights - height 229 cm

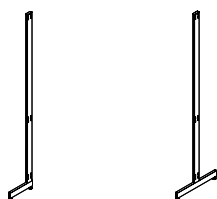

Shelf depth cm	Item no. Single-sided	Price EUR	Item no. Double-sided	Price EUR
22.5	B301060211	231,42	B301060212	254,56
25	B301060221	235,28	B301060222	257,89
30	B301060231	239,93	B301060232	265,20
40	B301060241	245,39	B301060242	284,22

80/30 Classic uprights - height 259 cm

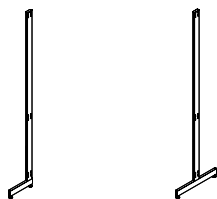

Shelf depth cm	Item no. Single-sided	Price EUR	Item no. Double-sided	Price EUR
22.5	B301060111	241,53	B301060112	265,60
25	B301060121	246,85	B301060122	271,32
30	B301060131	252,17	B301060132	278,37
40	B301060141	256,42	B301060142	296,59

UPRIGHTS

60/30 CLASSIC WALL STRIPS

60/30 Classic wall strips



Height
cm

112.5
142.5
172.5
202.5

Item no.

B30105011
B30105014
B30105017
B30105020

Price
EUR

25,00
32,32
36,97
42,03

UPRIGHTS

COMPONENTS FOR HIDDEN CASTOR ASSEMBLY ON 60/30 CLASSIC DOUBLE-SIDED SHELVING

60/30 Classic double-sided upright - height 92 cm

Only to be used with the wheel frame and castor set below. Adjustment of levelling glide makes the shelving non-moveable.



Shelf depth cm	Item no.	Price EUR
22.5	B30101671	168,38
25	B30101672	173,30
30	B30101673	179,82
40	B30101674	186,47

60/30 Classic double-sided upright - height 122 cm

Only to be used with the wheel frame and castor set below. Adjustment of levelling glide makes the shelving non-moveable.



Shelf depth cm	Item no.	Price EUR
22.5	B30101621	186,87
25	B30101622	192,32
30	B30101623	199,50
40	B30101624	207,08

60/30 Classic double-sided upright - height 152 cm

Only to be used with the wheel frame and castor set below. Adjustment of levelling glide makes the shelving non-moveable.



Shelf depth cm	Item no.	Price EUR
22.5	B30101651	208,94
25	B30101652	214,00
30	B30101653	218,65
40	B30101654	230,76

Castor frame and castor set for 60/30 Classic double-sided upright

Fittings included. To hide castors, use plinth for 60/30 shelving, see page 139.



Module cm	Item no.	Price EUR
75	B3010187	461,24
90	B3010189	461,24
100	B3010181	495,29

COMPONENTS

UPRIGHT EXTENSIONS, CROSSBARS & ANTI-TOPPLE BRACKETS

Upright extension

H30 x D6/D8 x W3 cm.

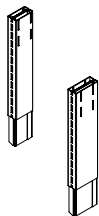

	Item no. 60/30	Price EUR	Item no. 80/30	Price EUR
Single-sided	B3011103061	53,33	B3011103081	63,57
Double-sided	B3011103062	55,99	B3011103082	66,23

Crossbar

See technical specifications for amount of crossbars per unit.

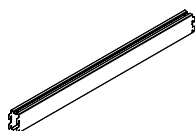

Module cm	Item no.	Price EUR
75	B3010127	60,91
90	B3010129	66,23
100	B3010121	72,09

Anti-topple bracket

Secures single-sided bays to wall.

Item no.	Price EUR
B115507	-

COMPONENTS

PLINTHS & CASTORS

Steel plinth for 60/30 Classic

H6 x top D3.2 cm. Including screws.

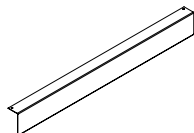

Module cm	Bays	Item no.	Price EUR
75	1	B302015701	28,60
75	2	B302015702	52,67
75	3	B302015703	68,10
90	1	B302015901	29,53
90	2	B302015902	53,07
100	1	B302015101	30,32
100	2	B302015102	55,73

Steel plinth for 60/30 Classic - extra depth

H6 x top D13.2 cm. Including screws. To be used when magazine display B3051xx is placed furthest down.

Module cm	Bays	Item no.	Price EUR
75	1	B302025701	28,60
75	2	B302025702	52,67
75	3	B302025703	68,10
90	1	B302025901	29,53
90	2	B302025902	53,07
100	1	B302025101	30,32
100	2	B302025102	55,73

Steel plinth for 80/30 Classic

H8 x top D3.2 cm. Including pins.

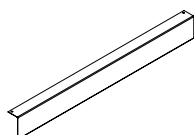

Module cm	Bays	Item no. 80/30	Price EUR
75	1	B3020167	22,21
90	1	B3020169	24,87
100	1	B3020161	32,19

Castors

H9.9 cm.

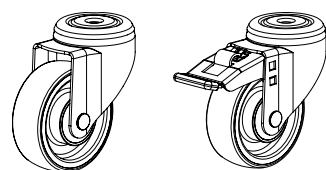

Brakes	Item no.	Price EUR
Without	B3060000	51,87
With	B3060001	72,22

PANELS

PAINTED WOODEN END PANELS

Painted FSC wooden end panel - single-sided

19 mm front edge. Incl. fittings. These end panels are not compatible with 60/30 Classic wall steel shelving.



Height cm	Shelf depth cm	Item no. Left	Price EUR	Item no. Right	Price EUR
92	22.5	B3016657175	132,20	B3016657185	132,20
92	25	B3016657275	137,26	B3016657285	137,26
92	30	B3016657375	138,05	B3016657385	138,05
92	40	B3016657475	171,17	B3016657485	171,17
122	22.5	B3016652175	175,43	B3016652185	175,43
122	25	B3016652275	182,48	B3016652285	182,48
122	30	B3016652375	183,27	B3016652385	183,27
122	40	B3016652475	226,90	B3016652485	226,90
152	22.5	B3016655175	183,27	B3016655185	183,27
152	25	B3016655275	196,71	B3016655285	196,71
152	30	B3016655375	223,97	B3016655385	223,97
152	40	B3016655475	246,05	B3016655485	246,05
182	22.5	B3016658175	215,86	B3016658185	215,86
182	25	B3016658275	232,88	B3016658285	232,88
182	30	B3016658375	233,55	B3016658385	233,55
182	40	B3016658475	291,40	B3016658485	291,40
199.5	22.5	B3016659175	213,20	B3016659185	213,20
199.5	25	B3016659275	223,44	B3016659285	223,44
199.5	30	B3016659375	263,87	B3016659385	263,87
199.5	40	B3016659475	328,64	B3016659485	328,64
212	22.5	B3016651175	226,63	B3016651185	226,63
212	25	B3016651275	236,74	B3016651285	236,74
212	30	B3016651375	269,72	B3016651385	269,72
212	40	B3016651475	337,16	B3016651485	337,16

Painted FSC wooden end panel - double-sided

19 mm front edge. Incl. fittings. These end panels are not compatible with hidden castor frames.

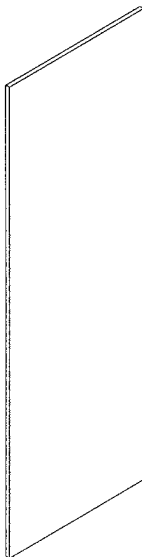

Height cm	Shelf depth cm	Item no.	Price EUR
92	22.5	B3016657195	175,83
92	25	B3016657295	190,32
92	30	B3016657395	219,72
92	40	B3016657495	277,70
122	22.5	B3016652195	233,42
122	25	B3016652295	252,43
122	30	B3016652395	291,27
122	40	B3016652495	368,28
152	22.5	B3016655195	282,76
152	25	B3016655295	307,50
152	30	B3016655395	354,84
152	40	B3016655495	451,67
182	22.5	B3016658195	333,03
182	25	B3016658295	361,63
182	30	B3016658395	419,62
182	40	B3016658495	535,46
199.5	22.5	B3016659195	373,07
199.5	25	B3016659295	406,85
199.5	30	B3016659395	472,55
199.5	40	B3016659495	603,16
212	22.5	B3016651195	382,24
212	25	B3016651295	416,69
212	30	B3016651395	484,39
212	40	B3016651495	618,98

PANELS

VENEER WOODEN END PANELS

Veneer FSC wooden end panel - single-sided

19 mm front edge. Incl. fittings. These end panels are not compatible with 60/30 Classic wall steel shelving.



Height cm	Shelf depth cm	Item no. Left	Price EUR	Item no. Right	Price EUR
92	22.5	B3016657171	185,14	B3016657181	185,14
92	25	B3016657271	192,19	B3016657281	192,19
92	30	B3016657371	193,38	B3016657381	193,38
92	40	B3016657471	239,67	B3016657481	239,67
122	22.5	B3016652171	245,65	B3016652181	245,65
122	25	B3016652271	255,49	B3016652281	255,49
122	30	B3016652371	256,56	B3016652381	256,56
122	40	B3016652471	317,60	B3016652481	317,60
152	22.5	B3016655171	256,56	B3016655181	256,56
152	25	B3016655271	275,44	B3016655281	275,44
152	30	B3016655371	313,61	B3016655381	313,61
152	40	B3016655471	344,47	B3016655481	344,47
182	22.5	B3016658171	302,18	B3016658181	302,18
182	25	B3016658271	325,98	B3016658281	325,98
182	30	B3016658371	326,91	B3016658381	326,91
182	40	B3016658471	408,04	B3016658481	408,04
199.5	22.5	B3016659171	298,45	B3016659181	298,45
199.5	25	B3016659271	312,82	B3016659281	312,82
199.5	30	B3016659371	369,47	B3016659381	369,47
199.5	40	B3016659471	460,18	B3016659481	460,18
212	22.5	B3016651171	317,21	B3016651181	317,21
212	25	B3016651271	331,57	B3016651281	331,57
212	30	B3016651371	377,72	B3016651381	377,72
212	40	B3016651471	472,02	B3016651481	472,02

Veneer FSC wooden end panel - double-sided

19 mm front edge. Incl. fittings. These end panels are not compatible with hidden castor frames.



Height cm	Shelf depth cm	Item no.	Price EUR
92	22.5	B3016657191	246,18
92	25	B3016657291	266,40
92	30	B3016657391	307,63
92	40	B3016657491	388,76
122	22.5	B3016652191	326,78
122	25	B3016652291	353,51
122	30	B3016652391	407,91
122	40	B3016652491	515,51
152	22.5	B3016655191	395,81
152	25	B3016655291	430,52
152	30	B3016655391	496,76
152	40	B3016655491	632,28
182	22.5	B3016658191	466,30
182	25	B3016658291	506,33
182	30	B3016658391	587,46
182	40	B3016658491	749,72
199.5	22.5	B3016659191	522,42
199.5	25	B3016659291	569,51
199.5	30	B3016659391	661,54
199.5	40	B3016659491	844,28
212	22.5	B3016651191	535,19
212	25	B3016651291	583,47
212	30	B3016651391	678,17
212	40	B3016651491	866,50

PANELS

PAINTED WOODEN SLAT END PANELS

Painted FSC wooden slat end panel - single-sided

22 mm front edge. Incl. fittings. These end panels are not compatible with 60/30 Classic wall steel shelving.

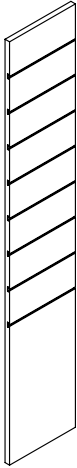

Height cm	Shelf depth cm	Item no. Left	Price EUR	Item no. Right	Price EUR
92	22.5	B3016747175	167,45	B3016747185	167,45
92	25	B3016747275	175,43	B3016747285	175,43
92	30	B3016747375	184,34	B3016747385	184,34
92	40	B3016747475	227,03	B3016747485	227,03
122	22.5	B3016742175	221,84	B3016742185	221,84
122	25	B3016742275	232,88	B3016742285	232,88
122	30	B3016742375	244,45	B3016742385	244,45
122	40	B3016742475	301,38	B3016742485	301,38
152	22.5	B3016745175	255,23	B3016745185	255,23
152	25	B3016745275	266,67	B3016745285	266,67
152	30	B3016745375	287,01	B3016745385	287,01
152	40	B3016745475	355,91	B3016745485	355,91
182	22.5	B3016748175	279,03	B3016748185	279,03
182	25	B3016748275	292,20	B3016748285	292,20
182	30	B3016748375	316,27	B3016748385	316,27
182	40	B3016748475	392,35	B3016748485	392,35
212	22.5	B3016741175	314,81	B3016741185	314,81
212	25	B3016741275	329,18	B3016741285	329,18
212	30	B3016741375	355,91	B3016741385	355,91
212	40	B3016741475	442,36	B3016741485	442,36

Painted FSC wooden slat end panel - double-sided

22 mm front edge. Incl. fittings. These end panels are not compatible with hidden castor frames.

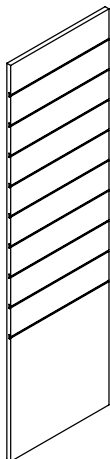

Height cm	Shelf depth cm	Item no.	Price EUR
92	22.5	B3016747195	280,36
92	25	B3016747295	294,73
92	30	B3016747395	307,90
92	40	B3016747495	315,08
122	22.5	B3016742195	372,13
122	25	B3016742295	390,89
122	30	B3016742395	408,18
122	40	B3016742495	417,89
152	22.5	B3016745195	428,26
152	25	B3016745295	445,55
152	30	B3016745395	480,66
152	40	B3016745495	492,23
182	22.5	B3016748195	467,76
182	25	B3016748295	489,17
182	30	B3016748395	529,61
182	40	B3016748495	541,58
212	22.5	B3016741195	526,28
212	25	B3016741295	550,35
212	30	B3016741395	595,44
212	40	B3016741495	609,14

PANELS

VENEER WOODEN SLAT END PANELS

Veneer FSC wooden slat end panel - single-sided

22 mm front edge. Incl. fittings. These end panels are not compatible with 60/30 Classic wall steel shelving.



Height cm	Shelf depth cm	Item no. Left	Price EUR	Item no. Right	Price EUR
92	22.5	B3016747171	234,35	B3016747181	234,35
92	25	B3016747271	245,65	B3016747281	245,65
92	30	B3016747371	258,02	B3016747381	258,02
92	40	B3016747471	317,74	B3016747481	317,74
122	22.5	B3016742171	310,56	B3016742181	310,56
122	25	B3016742271	325,98	B3016742281	325,98
122	30	B3016742371	342,21	B3016742381	342,21
122	40	B3016742471	422,01	B3016742481	422,01
152	22.5	B3016745171	357,24	B3016745181	357,24
152	25	B3016745271	373,33	B3016745281	373,33
152	30	B3016745371	401,79	B3016745381	401,79
152	40	B3016745471	498,35	B3016745481	498,35
182	22.5	B3016748171	390,62	B3016748181	390,62
182	25	B3016748271	408,98	B3016748281	408,98
182	30	B3016748371	442,76	B3016748381	442,76
182	40	B3016748471	549,29	B3016748481	549,29
212	22.5	B3016741171	440,63	B3016741181	440,63
212	25	B3016741271	460,98	B3016741281	460,98
212	30	B3016741371	498,35	B3016741381	498,35
212	40	B3016741471	619,38	B3016741481	619,38

Veneer FSC wooden slat end panel - double-sided

22 mm front edge. Incl. fittings. These end panels are not compatible with hidden castor frames.

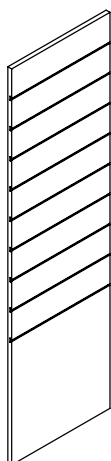

Height cm	Shelf depth cm	Item no.	Price EUR
92	22.5	B3016747191	392,62
92	25	B3016747291	412,57
92	30	B3016747391	431,19
92	40	B3016747491	441,03
122	22.5	B3016742191	521,09
122	25	B3016742291	547,16
122	30	B3016742391	571,37
122	40	B3016742491	584,93
152	22.5	B3016745191	599,43
152	25	B3016745291	623,77
152	30	B3016745391	672,98
152	40	B3016745491	689,21
182	22.5	B3016748191	654,76
182	25	B3016748291	684,82
182	30	B3016748391	741,48
182	40	B3016748491	758,23
212	22.5	B3016741191	736,69
212	25	B3016741291	770,47
212	30	B3016741391	833,64
212	40	B3016741491	852,80

PANELS

PAINTED LONDON WOODEN END PANELS - FOR STEEL TOP SHELF

Painted FSC London wooden end panel for steel top shelf - single-sided

30 mm front edge. To be used with steel top shelf, see pages 76-95. Incl. fittings. These end panels are not compatible with 60/30 Classic Classic wall steel shelving.

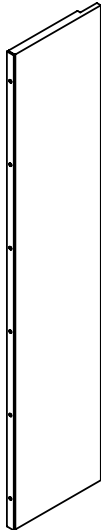

Height cm	Shelf depth cm	Item no. Left	Price EUR	Item no. Right	Price EUR
92	22.5	B3021257172	182,21	B3021257182	182,21
92	25	B3021257272	191,65	B3021257282	191,65
92	30	B3021257372	211,20	B3021257382	211,20
92	40	B3021257472	250,04	B3021257482	250,04
122	22.5	B3021252172	229,56	B3021252182	229,56
122	25	B3021252272	241,40	B3021252282	241,40
122	30	B3021252372	266,40	B3021252382	266,40
122	40	B3021252472	315,34	B3021252482	315,34
152	22.5	B3021255172	273,85	B3021255182	273,85
152	25	B3021255272	288,34	B3021255282	288,34
152	30	B3021255372	316,94	B3021255382	316,94
152	40	B3021255472	379,05	B3021255482	379,05
182	22.5	B3021258172	313,75	B3021258182	313,75
182	25	B3021258272	330,24	B3021258282	330,24
182	30	B3021258372	367,75	B3021258382	367,75
182	40	B3021258472	441,29	B3021258482	-
212	22.5	B3021251172	361,89	B3021251182	361,89
212	25	B3021251272	380,91	B3021251282	380,91
212	30	B3021251372	421,88	B3021251382	421,88
212	40	B3021251472	508,19	B3021251482	508,19

Painted FSC London wooden end panel for steel top shelf - double-sided

30 mm front edge. To be used with steel top shelf, see pages 76-95. Incl. fittings.

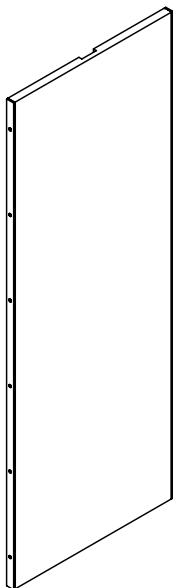

Height cm	Shelf depth cm	Item no.	Price EUR
92	22.5	B3021257192	329,57
92	25	B3021257292	347,00
92	30	B3021257392	385,83
92	40	B3021257492	463,90
122	22.5	B3021252192	416,29
122	25	B3021252292	438,10
122	30	B3021252392	487,05
122	40	B3021252492	585,73
152	22.5	B3021255192	492,90
152	25	B3021255292	518,83
152	30	B3021255392	580,15
152	40	B3021255492	703,44
182	22.5	B3021258192	569,91
182	25	B3021258292	599,96
182	30	B3021258392	673,51
182	40	B3021258492	820,34
212	22.5	B3021251192	654,63
212	25	B3021251292	689,07
212	30	B3021251392	774,59
212	40	B3021251492	946,43

PANELS

PAINTED LONDON WOODEN END PANELS - FOR LONDON OVERLAYING TOP PLATE

Painted FSC London wooden end panel for wooden overlaying top plate - single-sided

30 mm front edge. To be used with London wooden overlaying top, see pages 106-111. Incl. fittings. These end panels are not compatible with 60/30 Classic wall steel shelving.

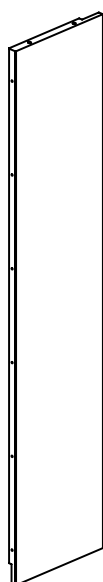

Height cm	Shelf depth cm	Item no. Left	Price EUR	Item no. Right	Price EUR
92	22.5	B3021257171	182,21	B3021257181	182,21
92	25	B3021257271	191,65	B3021257281	191,65
92	30	B3021257371	211,20	B3021257381	211,20
92	40	B3021257471	250,04	B3021257481	250,04
122	22.5	B3021252171	229,56	B3021252181	229,56
122	25	B3021252271	241,40	B3021252281	241,40
122	30	B3021252371	266,40	B3021252381	266,40
122	40	B3021252471	315,34	B3021252481	315,34
152	22.5	B3021255171	273,85	B3021255181	273,85
152	25	B3021255271	288,34	B3021255281	288,34
152	30	B3021255371	316,94	B3021255381	316,94
152	40	B3021255471	379,05	B3021255481	379,05
182	22.5	B3021258171	313,75	B3021258181	313,75
182	25	B3021258271	331,04	B3021258281	330,24
182	30	B3021258371	367,75	B3021258381	367,75
182	40	B3021258471	441,29	B3021258481	441,29
212	22.5	B3021251171	361,89	B3021251181	361,89
212	25	B3021251271	380,91	B3021251281	380,91
212	30	B3021251371	421,88	B3021251381	421,88
212	40	B3021251471	508,19	B3021251481	508,19

Painted FSC London wooden end panel for wooden overlaying top plate - double-sided

30 mm front edge. To be used with London wooden overlaying top, see pages 106-111. Incl. fittings.

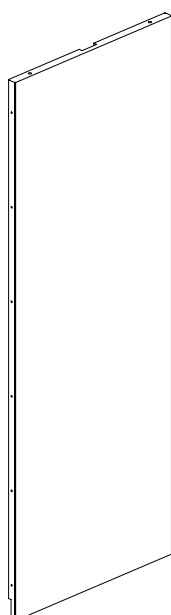

Height cm	Shelf depth cm	Item no.	Price EUR
92	22.5	B3021257191	329,57
92	25	B3021257291	347,00
92	30	B3021257391	385,83
92	40	B3021257491	463,90
122	22.5	B3021252191	416,29
122	25	B3021252291	438,10
122	30	B3021252391	487,05
122	40	B3021252491	585,73
152	22.5	B3021255191	492,90
152	25	B3021255291	518,83
152	30	B3021255391	580,15
152	40	B3021255491	703,44
182	22.5	B3021258191	569,91
182	25	B3021258291	599,96
182	30	B3021258391	673,51
182	40	B3021258491	820,34
212	22.5	B3021251191	654,63
212	25	B3021251291	689,07
212	30	B3021251391	774,59
212	40	B3021251491	946,43

PANELS

PERFORATED STEEL END PANEL

Perforated steel end panels - single-sided

45 mm frontedge. One A5 acrylic cover for signage and fittings are included. Hole size Ø4,5 mm. These end panels are not compatible with 60/30 Classic wall steel shelving.

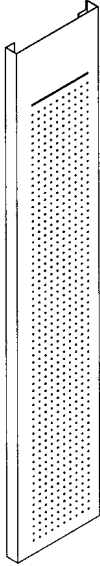

Height cm	Shelf depth cm	Item no. Left	Price EUR	Item no. Right	Price EUR
92	22.5	B301600717	142,18	B301600718	142,18
92	25	B301600727	146,57	B301600728	146,57
92	30	B301600737	153,48	B301600738	153,48
92	40	B301600747	168,38	B301600748	168,38
122	22.5	B301600217	149,49	B301600218	149,49
122	25	B301600227	154,41	B301600228	154,41
122	30	B301600237	161,86	B301600238	161,86
122	40	B301600247	177,02	B301600248	177,02
152	22.5	B301600517	190,19	B301600518	190,19
152	25	B301600527	195,38	B301600528	195,38
152	30	B301600537	202,56	B301600538	202,56
152	40	B301600547	218,39	B301600548	218,39
182	22.5	B301600817	211,47	B301600818	211,47
182	25	B301600827	216,39	B301600828	216,39
182	30	B301600837	225,83	B301600838	225,83
182	40	B301600847	243,52	B301600848	243,52
199.5	22.5	B301600917	225,17	B301600918	225,17
199.5	25	B301600927	229,03	B301600928	229,03
199.5	30	B301600937	239,93	B301600938	239,93
199.5	40	B301600947	258,55	B301600948	258,55
212	22.5	B301600117	234,48	B301600118	234,48
212	25	B301600127	239,93	B301600128	239,93
212	30	B301600137	249,64	B301600138	249,64
212	40	B301600147	269,59	B301600148	269,59

Perforated steel end panels - double-sided

45 mm frontedge. Two A5 acrylic covers for signage and fittings are included. Hole size Ø4,5 mm

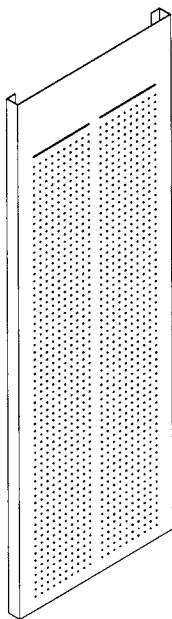

Height cm	Shelf depth cm	Item no.	Price EUR
92	22.5	B301600719	195,38
92	25	B301600729	202,29
92	30	B301600739	217,46
92	40	B301600749	246,98
122	22.5	B301600219	205,75
122	25	B301600229	213,33
122	30	B301600239	228,63
122	40	B301600249	259,88
152	22.5	B301600519	258,55
152	25	B301600529	269,59
152	30	B301600539	289,28
152	40	B301600549	328,91
182	22.5	B301600819	290,74
182	25	B301600829	303,11
182	30	B301600839	325,72
182	40	B301600849	373,33
199.5	22.5	B301600919	311,49
199.5	25	B301600929	324,12
199.5	30	B301600939	348,59
199.5	40	B301600949	399,00
212	22.5	B301600119	324,52
212	25	B301600129	336,89
212	30	B301600139	364,02
212	40	B301600149	417,22

PANELS

LONDON STEEL END PANELS - FOR LONDON STEEL OVERLAYING TOP PLATE

London steel end panel for London steel overlaying top plate - single-sided

30 mm front edge. To be used with London steel overlaying top plate, see page 98-99. Incl. fittings. These end panels are not compatible with 60/30 Classic wall steel shelving.

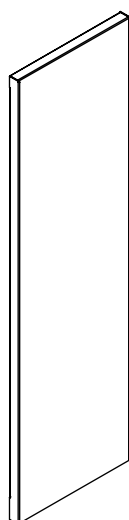

Height cm	Shelf depth cm	Item no. Left	Price EUR	Item no. Right	Price EUR
92	22.5	B30162071730	172,63	B30162071830	172,63
92	25	B30162072730	181,94	B30162072830	181,94
92	30	B30162073730	200,30	B30162073830	200,30
92	40	B30162074730	237,01	B30162074830	237,01
122	22.5	B30162012730	379,45	B30162021830	228,89
122	25	B30162022730	241,00	B30162022830	241,00
122	30	B30162023730	265,20	B30162023830	265,20
122	40	B30162024730	314,28	B30162024830	314,28
152	22.5	B30162051730	272,65	B30162051830	272,65
152	25	B30162052730	287,28	B30162052830	287,28
152	30	B30162053730	315,21	B30162053830	315,21
152	40	B30162054730	376,79	B30162054830	376,79
182	22.5	B30162081730	312,55	B30162081830	312,55
182	25	B30162082730	328,91	B30162082830	328,91
182	30	B30162083730	366,15	B30162083830	366,15
182	40	B30162084730	439,70	B30162084830	439,70
212	22.5	B30162011730	360,30	B30162011830	360,30
212	25	B30162012730	379,45	B30162012830	379,45
212	30	B30162013730	420,28	B30162013830	420,28
212	40	B30162014730	506,07	B30162014830	506,07

London steel end panel for London steel overlaying top plate - double-sided

30 mm front edge. To be used with London steel overlaying top plate, see page 100-101. Incl. fittings.

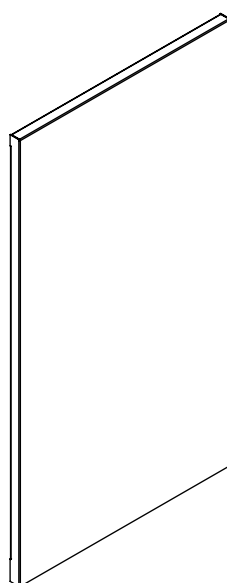

Height cm	Shelf depth cm	Item no.	Price EUR
92	22.5	B30162071930	312,55
92	25	B30162072930	328,91
92	30	B30162073930	365,75
92	40	B30162074930	439,83
122	22.5	B30162021930	414,56
122	25	B30162022930	436,11
122	30	B30162023930	485,32
122	40	B30162024930	583,34
152	22.5	B30162051930	491,04
152	25	B30162052930	516,84
152	30	B30162053930	577,89
152	40	B30162054930	700,11
182	22.5	B30162081930	567,25
182	25	B30162082930	597,17
182	30	B30162083930	670,85
182	40	B30162084930	817,55
212	22.5	B30162011930	651,04
212	25	B30162012930	685,48
212	30	B30162013930	771,27
212	40	B30162014930	942,17

PANELS

GLASS END PANELS

Glass end panel - single-sided

10 mm front edge. Incl. fittings. These end panels are not compatible with 60/30 Classic wall steel shelving.



Height cm	Shelf depth cm	Item no. Left	Price EUR	Item no. Right	Price EUR
92	22.5	B301647771	276,64	B301647871	276,64
92	25	B301647772	315,21	B301647872	315,21
92	30	B301647773	348,19	B301647873	348,19
92	40	B301647774	486,91	B301647874	486,91
122	22.5	B301647721	290,87	B301647821	290,87
122	25	B301647722	331,97	B301647822	331,97
122	30	B301647723	366,28	B301647823	366,28
122	40	B301647724	512,32	B301647824	512,32
152	22.5	B301647751	364,42	B301647851	364,42
152	25	B301647752	401,53	B301647852	401,53
152	30	B301647753	457,79	B301647853	457,79
152	40	B301647754	650,50	B301647854	650,50
182	22.5	B301647781	437,17	B301647881	437,17
182	25	B301647782	457,79	B301647882	457,79
182	30	B301647783	525,88	B301647883	525,88
182	40	B301647784	728,18	B301647884	728,18
199.5	22.5	B301647791	480,66	B301647891	480,66
199.5	25	B301647792	501,41	B301647892	501,41
199.5	30	B301647793	568,84	B301647893	568,84
199.5	40	B301647794	771,13	B301647894	771,13
212	22.5	B301647711	511,25	B301647811	511,25
212	25	B301647712	513,38	B301647812	513,38
212	30	B301647713	571,63	B301647813	571,63
212	40	B301647714	830,72	B301647814	830,72

Glass end panel - double-sided

10 mm front edge. Incl. fittings.

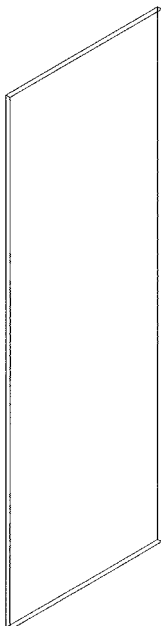

Height cm	Shelf depth cm	Item no.	Price EUR
92	22.5	B301647971	478,53
92	25	B301647972	487,05
92	30	B301647973	562,99
92	40	B301647974	638,13
122	22.5	B301647921	503,41
122	25	B301647922	512,45
122	30	B301647923	592,38
122	40	B301647924	671,78
152	22.5	B301647951	630,29
152	25	B301647952	650,50
152	30	B301647953	751,85
152	40	B301647954	853,86
182	22.5	B301647981	757,44
182	25	B301647982	728,18
182	30	B301647983	842,02
182	40	B301647984	956,80
199.5	22.5	B301647991	831,38
199.5	25	B301647992	912,11
199.5	30	B301647993	1.074,24
199.5	40	B301647994	838,57
212	22.5	B301647911	884,32
212	25	B301647912	830,72
212	30	B301647913	965,85
212	40	B301647914	1.101,24

PANELS

WOODEN BACK PANELS

FSC wooden back panel

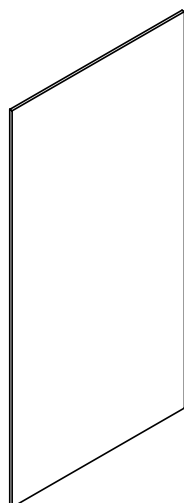

Height cm	Module cm	Item no. Painted	Price EUR	Item no. Veneer	Price EUR
92	75	B301902775	151,49	B301902771	212,00
92	90	B301902795	183,14	B301902791	256,29
92	100	B301902715	205,09	B301902711	287,01
122	75	B301902275	168,25	B301902271	235,54
122	90	B301902295	203,49	B301902291	284,89
122	100	B301902215	227,56	B301902211	318,54
152	75	B301902575	222,91	B301902571	312,02
152	90	B301902595	268,79	B301902591	376,39
152	100	B301902515	301,38	B301902511	422,01
182	75	B301902875	276,77	B301902871	387,43
182	90	B301902895	334,50	B301902891	468,29
182	100	B301902815	375,06	B301902811	525,08
199.5	75	B301902975	308,43	B301902971	431,72
199.5	90	B301902995	372,93	B301902991	522,16
199.5	100	B301902915	418,15	B301902911	585,33
212	75	B301902175	331,30	B301902171	463,77
212	90	B301902195	401,00	B301902191	561,26
212	100	B301902115	449,41	B301902111	629,22

Fittings for wooden end panel

Type	Item no. Heights < 152 cm	Price EUR	Item no. Heights > =152 cm	Price EUR
Left	B30165227	23,81	B30165217	33,25
Right	B30165228	23,81	B30165218	33,25
Double	B30165229	47,35	B30165219	65,30

Fittings for wooden display end panel

Type	Item no. Heights < 152 cm	Price EUR	Item no. Heights > =152 cm	Price EUR
Left	B30167227	23,81	B30167217	33,25
Right	B30167228	23,81	B30167218	33,25
Double	B30167229	47,35	B30167219	65,30

Fittings for glass end panel

Type	Item no.	Price EUR
Left	B3016487	174,10
Right	B3016488	174,10
Double	B3016489	115,18



END PANEL BAYS

FOR DOUBLE-SIDED 60/30 CLASSIC STEEL SHELVING

The following pages will show basic configurations of end panel bays for double-sided 60/30 Classic Steel Shelving system.



END PANEL BAYS

FOR DOUBLE-SIDED SHELVING WITH ADJUSTABLE FEET

FSC-approved end panel bay with wooden top shelf, wooden panels, wooden bottom shelf and adjustable feet. For shelves, see page 158.

Height 92 cm

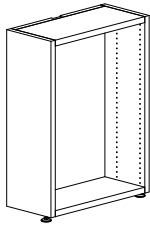

Depth of shelving system - cm	Width of end panel bay - cm	Depth of end panel bay - cm	Item no. Painted	Price EUR	Item no. Veneer	Price EUR
22,5/22,5	46,8	25	BB30130706005	1.133,83	BB30130706001	1.587,36
25/25	51,8	25	BB30130714005	1.133,83	BB30130714001	1.587,36
30/30	61,8	25	BB30130722005	1.270,15	BB30130722001	1.778,21
40/40	81,8	25	BB30130730005	1.451,56	BB30130730001	2.032,24
22,5/22,5	46,8	30	BB30130707005	1.133,83	BB30130707001	1.587,36
25/25	51,8	30	BB30130715005	1.133,83	BB30130715001	1.587,36
30/30	61,8	30	BB30130723005	1.270,15	BB30130723001	1.778,21
40/40	81,8	30	BB30130731005	1.451,56	BB30130731001	2.032,24

Height 122

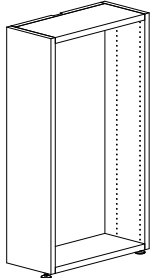

Depth of shelving system - cm	Width of end panel bay - cm	Depth of end panel bay - cm	Item no. Painted	Price EUR	Item no. Veneer	Price EUR
22,5/22,5	46,8	25	BB30130206005	1.486,41	BB30130206001	2.080,92
25/25	51,8	25	BB30130214005	1.486,41	BB30130214001	2.080,92
30/30	61,8	25	BB30130222005	1.667,29	BB30130222001	2.334,15
40/40	81,8	25	BB30130230005	1.907,75	BB30130230001	2.670,91
22,5/22,5	46,8	30	BB30130207005	1.486,41	BB30130207001	2.080,92
25/25	51,8	30	BB30130215005	1.486,41	BB30130215001	2.080,92
30/30	61,8	30	BB30130223005	1.667,29	BB30130223001	2.334,15
40/40	81,8	30	BB30130231005	1.907,75	BB30130231001	2.670,91

Height 152 cm

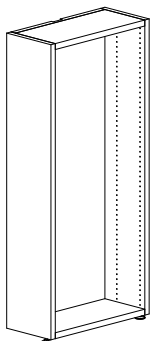

Depth of shelving system - cm	Width of end panel bay - cm	Depth of end panel bay - cm	Item no. Painted	Price EUR	Item no. Veneer	Price EUR
22,5/22,5	46,8	25	BB30130506005	1.838,59	BB30130506001	2.574,08
25/25	51,8	25	BB30130514005	1.838,59	BB30130514001	2.574,08
30/30	61,8	25	BB30130522005	2.063,76	BB30130522001	2.889,29
40/40	81,8	25	BB30130530005	2.363,81	BB30130530001	3.309,31
22,5/22,5	46,8	30	BB30130507005	1.838,59	BB30130507001	2.574,08
25/25	51,8	30	BB30130515005	1.838,59	BB30130515001	2.574,08
30/30	61,8	30	BB30130523005	2.063,76	BB30130523001	2.889,29
40/40	81,8	30	BB30130531005	2.363,81	BB30130531001	3.309,31

END PANEL BAYS

FOR DOUBLE-SIDED SHELVING WITH ADJUSTABLE FEET

FSC-approved end panel bay with wooden top shelf, wooden panels, wooden bottom shelf and adjustable feet. For shelves, see page 158.

Height 182 cm

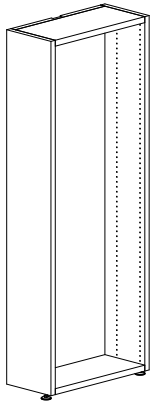

Depth of shelving system - cm	Width of end panel bay - cm	Depth of end panel bay - cm	Item no. Painted	Price EUR	Item no. Veneer	Price EUR
22,5/22,5	46,8	25	BB30130806005	2.191,04	BB30130806001	3.067,51
25/25	51,8	25	BB30130814005	2.191,04	BB30130814001	3.067,51
30/30	61,8	25	BB30130822005	2.460,90	BB30130822001	3.445,23
40/40	81,8	25	BB30130830005	2.819,60	BB30130830001	3.947,44
22,5/22,5	46,8	30	BB30130807005	2.191,04	BB30130807001	3.067,51
25/25	51,8	30	BB30130815005	2.191,04	BB30130815001	3.067,51
30/30	61,8	30	BB30130823005	2.460,90	BB30130823001	3.445,23
40/40	81,8	30	BB30130831005	2.819,60	BB30130831001	3.947,44

Height 212 cm

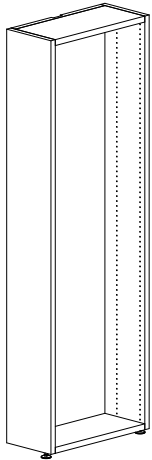

Depth of shelving system - cm	Width of end panel bay - cm	Depth of end panel bay - cm	Item no. Painted	Price EUR	Item no. Veneer	Price EUR
22,5/22,5	46,8	25	BB30130106005	2.543,49	BB30130106001	3.560,94
25/25	51,8	25	BB30130114005	2.543,49	BB30130114001	3.560,94
30/30	61,8	25	BB30130122005	2.857,37	BB30130122001	4.000,37
40/40	81,8	25	BB30130130005	3.275,92	BB30130130001	4.586,24
22,5/22,5	46,8	30	BB30130107005	2.543,49	BB30130107001	3.560,94
25/25	51,8	30	BB30130115005	2.543,49	BB30130115001	3.560,94
30/30	61,8	30	BB30130123005	2.857,37	BB30130123001	4.000,37
40/40	81,8	30	BB30130131005	3.275,92	BB30130131001	4.586,24

END PANEL BAYS

FOR DOUBLE-SIDED SHELVING WITH AJDUSTABLE FEET & LONDON WOODEN TOP PLATE

FSC-approved end panel bay with overlaying London wooden top plate, wooden panels, wooden bottom shelf and adjustable feet. For shelves, see page 158.

Height 92 cm

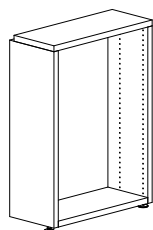

Depth of shelving system - cm	Width of end panel bay - cm	Depth of end panel bay - cm	Item no. Painted	Price EUR	Item no. Veneer	Price EUR
22,5/22,5	46,8	25	BB30131706005	1.133,83	BB30131706001	1.587,36
25/25	51,8	25	BB30131714005	1.133,83	BB30131714001	1.587,36
30/30	61,8	25	BB30131722005	1.270,15	BB30131722001	1.778,21
40/40	81,8	25	BB30131730005	1.451,56	BB30131730001	2.032,24
22,5/22,5	46,8	30	BB30131707005	1.133,83	BB30131707001	1.587,36
25/25	51,8	30	BB30131715005	1.133,83	BB30131715001	1.587,36
30/30	61,8	30	BB30131723005	1.270,15	BB30131723001	1.778,21
40/40	81,8	30	BB30131731005	1.451,56	BB30131731001	2.032,24

Height 122

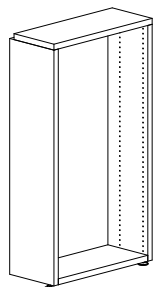

Depth of shelving system - cm	Width of end panel bay - cm	Depth of end panel bay - cm	Item no. Painted	Price EUR	Item no. Veneer	Price EUR
22,5/22,5	46,8	25	BB30131206005	1.486,41	BB30131206001	2.080,92
25/25	51,8	25	BB30131214005	1.486,41	BB30131214001	2.080,92
30/30	61,8	25	BB30131222005	1.667,29	BB30131222001	2.334,15
40/40	81,8	25	BB30131230005	1.907,75	BB30131230001	2.670,91
22,5/22,5	46,8	30	BB30131207005	1.486,41	BB30131207001	2.080,92
25/25	51,8	30	BB30131215005	1.486,41	BB30131215001	2.080,92
30/30	61,8	30	BB30131223005	1.667,29	BB30131223001	2.334,15
40/40	81,8	30	BB30131231005	1.907,75	BB30131231001	2.670,91

Height 152 cm

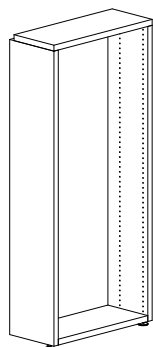

Depth of shelving system - cm	Width of end panel bay - cm	Depth of end panel bay - cm	Item no. Painted	Price EUR	Item no. Veneer	Price EUR
22,5/22,5	46,8	25	BB30131506005	1.838,59	BB30131506001	2.574,08
25/25	51,8	25	BB30131514005	1.838,59	BB30131514001	2.574,08
30/30	61,8	25	BB30131522005	2.063,76	BB30131522001	2.889,29
40/40	81,8	25	BB30131530005	2.363,81	BB30131530001	3.309,31
22,5/22,5	46,8	30	BB30131507005	1.838,59	BB30131507001	2.574,08
25/25	51,8	30	BB30131515005	1.838,59	BB30131515001	2.574,08
30/30	61,8	30	BB30131523005	2.063,76	BB30131523001	2.889,29
40/40	81,8	30	BB30131531005	2.363,81	BB30131531001	3.309,31

END PANEL BAYS

FOR DOUBLE-SIDED SHELVING WITH ADJUSTABLE FEET & LONDON WOODEN TOP PLATE

FSC-approved end panel bay with overlaying London wooden top plate, wooden panels, wooden bottom shelf and adjustable feet. For shelves, see page 158.

Height 182 cm

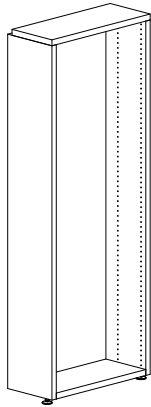

Depth of shelving system - cm	Width of end panel bay - cm	Depth of end panel bay - cm	Item no. Painted	Price EUR	Item no. Veneer	Price EUR
22,5/22,5	46,8	25	BB30131806005	2.191,04	BB30131806001	3.067,51
25/25	51,8	25	BB30131814005	2.191,04	BB30131814001	3.067,51
30/30	61,8	25	BB30131822005	2.460,90	BB30131822001	3.445,23
40/40	81,8	25	BB30131830005	2.819,60	BB30131830001	3.947,44
22,5/22,5	46,8	30	BB30131807005	2.191,04	BB30131807001	3.067,51
25/25	51,8	30	BB30131815005	2.191,04	BB30131815001	3.067,51
30/30	61,8	30	BB30131823005	2.460,90	BB30131823001	3.445,23
40/40	81,8	30	BB30131831005	2.819,60	BB30131831001	3.947,44

Height 212 cm

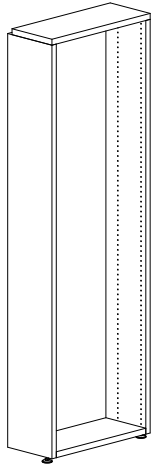

Depth of shelving system - cm	Width of end panel bay - cm	Depth of end panel bay - cm	Item no. Painted	Price EUR	Item no. Veneer	Price EUR
22,5/22,5	46,8	25	BB30131106005	2.543,49	BB30131106001	3.560,94
25/25	51,8	25	BB30131114005	2.543,49	BB30131114001	3.560,94
30/30	61,8	25	BB30131122005	2.857,37	BB30131122001	4.000,37
40/40	81,8	25	BB30131130005	3.275,92	BB30131130001	4.586,24
22,5/22,5	46,8	30	BB30131107005	2.543,49	BB30131107001	3.560,94
25/25	51,8	30	BB30131115005	2.543,49	BB30131115001	3.560,94
30/30	61,8	30	BB30131123005	2.857,37	BB30131123001	4.000,37
40/40	81,8	30	BB30131131005	3.275,92	BB30131131001	4.586,24

END PANEL BAYS

FOR DOUBLE-SIDED SHELVING WITH CASTORS

FSC-approved end panel bay with wooden top shelf, wooden panels, wooden bottom shelf and castors. For shelves, see page 158.

Height 92 cm

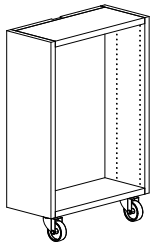

Depth of shelving system - cm	Width of end panel bay - cm	Depth of end panel bay - cm	Item no. Painted	Price EUR	Item no. Veneer	Price EUR
22,5/22,5	46,8	25	BB30134706005	1.237,57	BB30134706001	1.732,59
25/25	51,8	25	BB30134714005	1.237,57	BB30134714001	1.732,59
30/30	61,8	25	BB30134722005	1.373,89	BB30134722001	1.923,45
40/40	81,8	25	BB30134730005	1.555,30	BB30134730001	2.177,48
22,5/22,5	46,8	30	BB30134707005	1.237,57	BB30134707001	1.732,59
25/25	51,8	30	BB30134715005	1.237,57	BB30134715001	1.732,59
30/30	61,8	30	BB30134723005	1.373,89	BB30134723001	1.923,45
40/40	81,8	30	BB30134731005	1.555,30	BB30134731001	2.177,48

Height 122

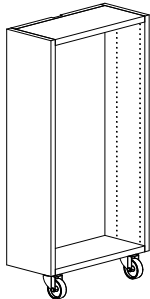

Depth of shelving system - cm	Width of end panel bay - cm	Depth of end panel bay - cm	Item no. Painted	Price EUR	Item no. Veneer	Price EUR
22,5/22,5	46,8	25	BB30134206005	1.590,15	BB30134206001	2.226,15
25/25	51,8	25	BB30134214005	1.590,15	BB30134214001	2.226,15
30/30	61,8	25	BB30134222005	1.771,03	BB30134222001	2.479,39
40/40	81,8	25	BB30134230005	2.011,49	BB30134230001	2.816,14
22,5/22,5	46,8	30	BB30134207005	1.590,15	BB30134207001	2.226,15
25/25	51,8	30	BB30134215005	1.590,15	BB30134215001	2.226,15
30/30	61,8	30	BB30134223005	1.771,03	BB30134223001	2.479,39
40/40	81,8	30	BB30134231005		BB30134231001	

Height 152 cm

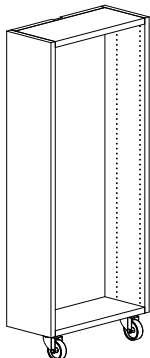

Depth of shelving system - cm	Width of end panel bay - cm	Depth of end panel bay - cm	Item no. Painted	Price EUR	Item no. Veneer	Price EUR
22,5/22,5	46,8	25	BB30134506005	1.942,33	BB30134506001	2.719,32
25/25	51,8	25	BB30134514005	1.942,33	BB30134514001	2.719,32
30/30	61,8	25	BB30134522005	2.167,50	BB30134522001	3.034,53
40/40	81,8	25	BB30134530005	2.467,55	BB30134530001	3.454,54
22,5/22,5	46,8	30	BB30134507005	1.942,33	BB30134507001	2.719,32
25/25	51,8	30	BB30134515005	1.942,33	BB30134515001	2.719,32
30/30	61,8	30	BB30134523005	2.167,50	BB30134523001	3.034,53
40/40	81,8	30	BB30134531005	2.467,55	BB30134531001	3.454,54

END PANEL BAYS

FOR DOUBLE-SIDED SHELVING WITH CASTORS & LONDON WOODEN TOP PLATE

FSC-approved end panel bay with overlaying London wooden top plate, wooden panels, wooden bottom shelf and castors. For shelves, see page 158.

Height 92 cm

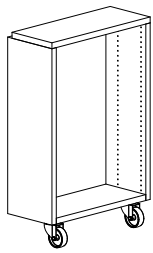

Depth of shelving system - cm	Width of end panel bay - cm	Depth of end panel bay - cm	Item no. Painted	Price EUR	Item no. Veneer	Price EUR
22,5/22,5	46,8	25	BB30135706005	1.237,57	BB30135706001	1.732,59
25/25	51,8	25	BB30135714005	1.237,57	BB30135714001	1.732,59
30/30	61,8	25	BB30135722005	1.373,89	BB30135722001	1.923,45
40/40	81,8	25	BB30135730005	1.555,30	BB30135730001	2.177,48
22,5/22,5	46,8	30	BB30135707005	1.237,57	BB30135707001	1.732,59
25/25	51,8	30	BB30135715005	1.237,57	BB30135715001	1.732,59
30/30	61,8	30	BB30135723005	1.373,89	BB30135723001	1.923,45
40/40	81,8	30	BB30135731005	1.555,30	BB30135731001	2.177,48

Height 122

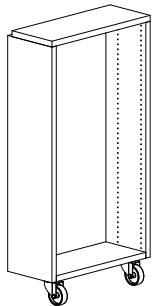

Depth of shelving system - cm	Width of end panel bay - cm	Depth of end panel bay - cm	Item no. Painted	Price EUR	Item no. Veneer	Price EUR
22,5/22,5	46,8	25	BB30135206005	1.590,15	BB30135206001	2.226,15
25/25	51,8	25	BB30135214005	1.590,15	BB30135214001	2.226,15
30/30	61,8	25	BB30135222005	1.771,03	BB30135222001	2.479,39
40/40	81,8	25	BB30135230005	2.011,49	BB30135230001	2.816,14
22,5/22,5	46,8	30	BB30135207005	1.590,15	BB30135207001	2.226,15
25/25	51,8	30	BB30135215005	1.590,15	BB30135215001	2.226,15
30/30	61,8	30	BB30135223005	1.771,03	BB30135223001	2.479,39
40/40	81,8	30	BB30135231005	2.011,49	BB30135231001	2.816,14

Height 152 cm

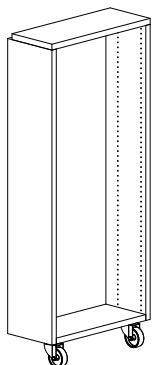

Depth of shelving system - cm	Width of end panel bay - cm	Depth of end panel bay - cm	Item no. Painted	Price EUR	Item no. Veneer	Price EUR
22,5/22,5	46,8	25	BB30135506005	1.942,33	BB30135506001	2.719,32
25/25	51,8	25	BB30135514005	1.942,33	BB30135514001	2.719,32
30/30	61,8	25	BB30135522005	2.167,50	BB30135522001	3.034,53
40/40	81,8	25	BB30135530005	2.467,55	BB30135530001	3.454,54
22,5/22,5	46,8	30	BB30135507005	1.942,33	BB30135507001	2.719,32
25/25	51,8	30	BB30135515005	1.942,33	BB30135515001	2.719,32
30/30	61,8	30	BB30135523005	2.167,50	BB30135523001	3.034,53
40/40	81,8	30	BB30135531005	2.467,55	BB30135531001	3.454,54

END PANEL BAYS

STEEL SHELVES

Steel shelf with steel backedge for backedge book support

Steel backedge 47 mm.
Brackets must be ordered
separately.

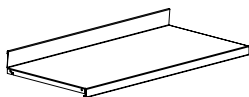

Depth of shelving system - cm	Depth of end panel bay - cm	Width of shelf - cm	Item no.	Price EUR
22,5/22,5	25	46,3	B30118206	70,22
25/25	25	51,3	B30118214	70,22
30/30	25	61,3	B30118222	77,14
40/40	25	71,3	B30118230	77,14
22,5/22,5	30	46,3	B30118207	70,22
25/25	30	51,3	B30118215	70,22
30/30	30	61,3	B30118223	77,14
40/40	30	71,3	B30118231	77,14

Bracket for steel shelves with steel backedge

* Can be used for D25 and
30 cm shelves.

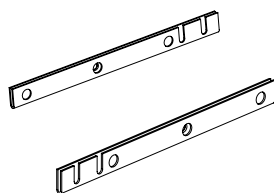

Type	Depth of end panel bay - cm	Item no.	Price EUR
Left	25	B78300128	17,82
Right	25	B78300129	17,82
Left*	30	B78300138	17,82
Right*	30	B78300139	17,82

45°/60° sloping steel shelf

With fittings.



Depth of shelving system - cm	Depth of end panel bay - cm	Item no.	Price EUR
22,5/22,5	25	B30118606	64,24
25/25	25	B30118614	64,24
30/30	25	B30118622	73,28
40/40	25	B30118630	73,28
22,5/22,5	30	B30118607	64,24
25/25	30	B30118615	64,24
30/30	30	B30118623	73,28
40/40	30	B30118631	73,28

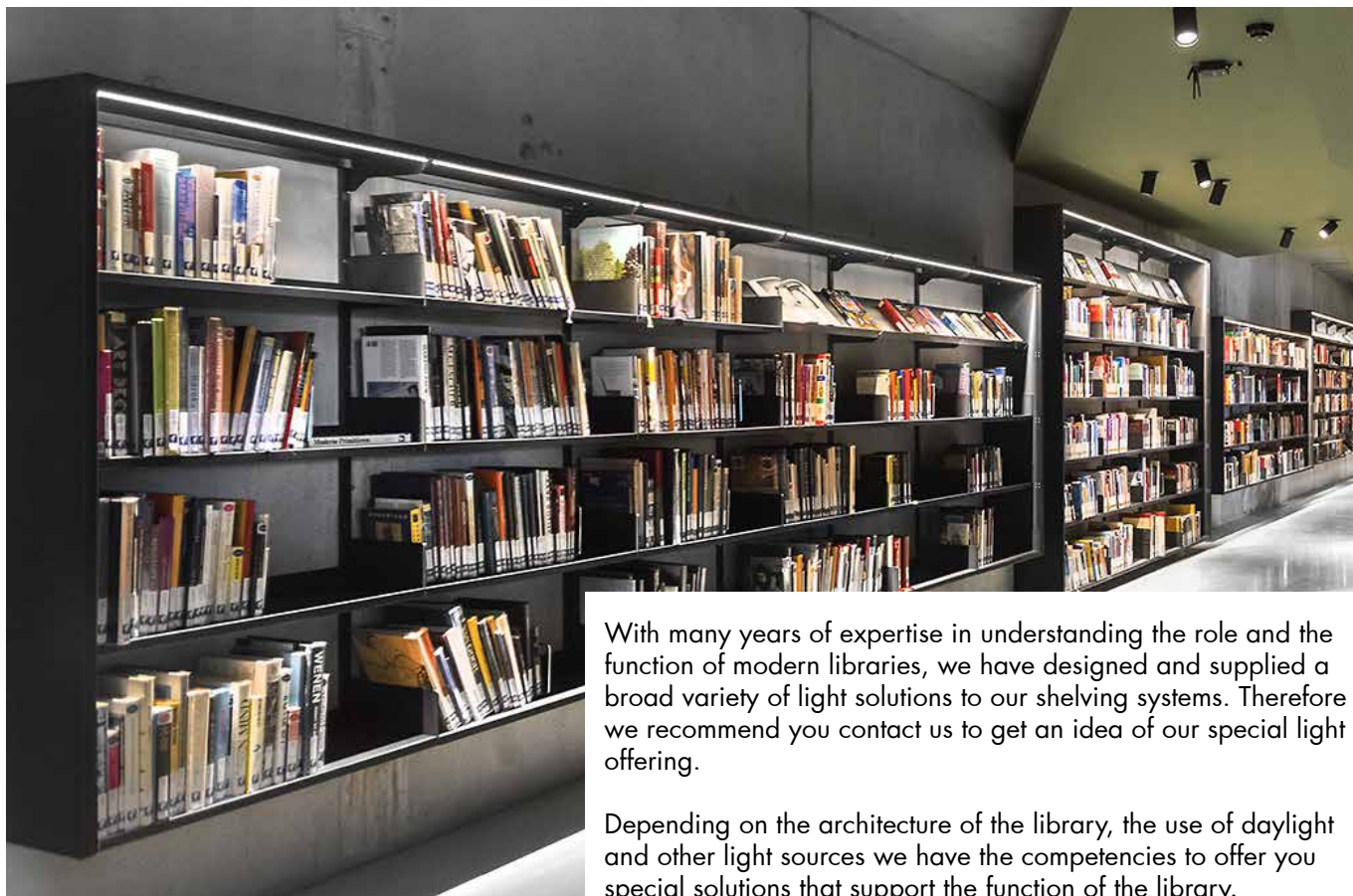

With many years of expertise in understanding the role and the function of modern libraries, we have designed and supplied a broad variety of light solutions to our shelving systems. Therefore we recommend you contact us to get an idea of our special light offering.

Depending on the architecture of the library, the use of daylight and other light sources we have the competencies to offer you special solutions that support the function of the library.

The LED lighting strips are mounted underneath each steel shelf to add light to the shelf below. You can find complete shelving configurations on page 40. Below you will find an overview of all components used in a configuration with LED lighting. It is also possible to construct your own shelving using the standard and special constructed components for LED lighting, contact Sales for further details.

Warm white LED lighting

Selfadhesive. 3000 kelvin. 12V. 4.8 W per meter. Energy efficiency A+. 60 diodes per meter. Light output (lm) 4.1 per meter.

Module cm
75
90
100

Item no.	Price EUR
B3900208	85,65
B3900205	88,58
B3900200	89,51

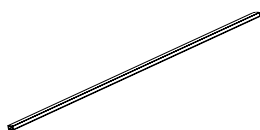

12V DC transformer for LED lighting

Up to 6 connections. 30 W. IP20.

Item no.	Price EUR
B3900202	64,37

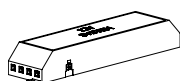

LIGHTING

LED SHELF LIGHTING

Transformer holder for LED lighting

1 pc. needed per bay.



Module cm

75
90
100

Item no.

B3030037
B3030039
B3030031

Price
EUR

62,38
67,30
73,42

Cable channel for LED lighting

To be mounted on the left hand side of the bay, on the inside of the upright.

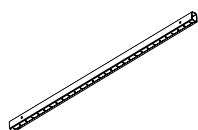

Height cm

122
152
182
212

Item no.

B3030042
B3030045
B3030048
B3030041

Price
EUR

68,89
102,41
122,09
138,32

Upright for LED lighting

With extra holes for mounting cable channel.

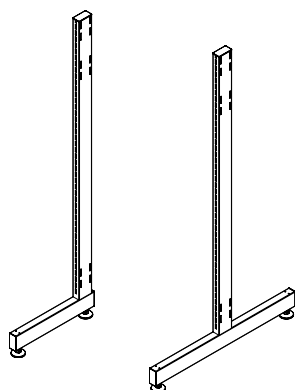

Height cm

122
122
122
122

152
152
152
152

182
182
182
182

212
212
212
212

Depth cm

22,5
25
30
40

22,5
25
30
40

22,5
25
30
40

22,5
25
30
40

Item no. - single

B303000211
B303000221
B303000231
B303000241

B303000511
B303000521
B303000531
B303000541

B303000811
B303000821
B303000831
B303000841

B303000111
B303000121
B303000131
B303000141

Price
EUR

147,10
153,35
155,74
159,87

163,19
166,65
168,64
171,30

177,56
179,95
182,48
186,87

192,72
195,91
198,44
202,29

Item no. - double

B303000212
B303000222
B303000232
B303000242

B303000512
B303000522
B303000532
B303000542

B303000812
B303000822
B303000832
B303000842

B303000112
B303000122
B303000132
B303000142

Price
EUR

160,93
164,92
171,17
177,56

179,82
183,54
188,20
197,77

188,20
196,31
201,50
211,34

209,61
212,14
214,40
223,71

Crossbar

2 pcs. per bay.

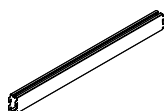

Module cm

75
90
100

Item no.

B3030027
B3030029
B3030021

Price
EUR

63,18
68,23
74,48

Steel shelves

The LED lighting is mounted underneath standard steel top shelves and steel intermediate shelves with backedge. See pages 66-73.

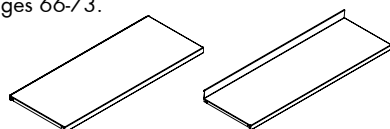



The Book LED lighting armature can be fitted on wooden top shelves and can be mounted over 1, 2 and 3 bays by use of connect fittings. Continuous runs also require connect fitting.

The armature is CE-approved and available in white and steel as standard. For other colours, please ask customer service.

Armature

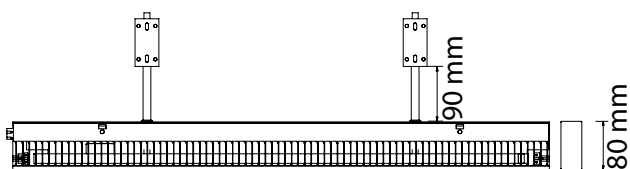

Model showing 2 bearing arms incl. light tube and louvre. Armature housing in aluminium.

Standard bearing arms

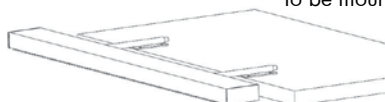

To be mounted on top of top shelf.

Front edge bearing arms

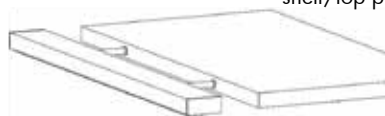

To be mounted on frontedge of predrilled top shelf/top plate (special request)

LIGHTING

BOOK LED LIGHTING

Below you will find a list of products needed when ordering lighting for 1, 2 or 3 bays. For 4 or more bays, you must use a combination of the armatures for 1, 2 or 3 bays by connecting the armatures with a connect fitting. Eg. for 10 bays, you can either use 5 x 2 bays (with 4 connect fittings) or 3 x 3 bays and 1 x 1 bay (with 3 connect fittings).

1 bay



	Item no.	Price EUR
Armature module 75 - W750 x D80 x H32 mm or	B3900100750	720,33
Armature module 90 - W900 x D80 x H32 mm or	B3900100900	777,65
Armature module 100 - W1005 x D80 x H32 mm	B3900101005	919,03
Bearing arms, 2 pcs., standard or	B39001512	160,13
Bearing arms, 2 pcs., front edge	B39001522	160,13
End covers, 2 pcs.	B390011	97,76

2 bays

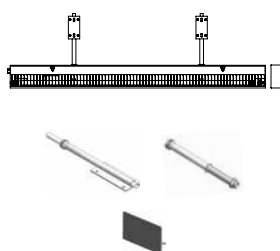

	Item no.	Price EUR
Armature module 75 + 75 - W1500 x D80 x H32 mm or	B3900101500	1.101,91
Armature module 90 + 90 - W1800 x D80 x H32 mm or	B3900101800	1.236,77
Armature module 90 + 100 - W1905 x D80 x H32 mm or	B3900101905	1.259,64
Armature module 100 + 100 - W2010 x D80 x H32 mm	B3900102010	1.362,45
Bearing arms, 2 pcs., standard or	B39001512	160,13
Bearing arms, 2 pcs., front edge	B39001522	160,13
End covers, 2 pcs.	B390011	97,76

3 bays



	Item no.	Price EUR
Armature module 75 + 75 + 75 - W2250 x D80 x H32 mm or	B3900102250	1.362,45
Armature module 75 + 90 + 75 - W2400 x D80 x H32 mm or	B3900102400	1.652,79
Armature module 90 + 90 + 90 - W2700 x D80 x H32 mm or	B3900102700	1.810,93
Armature module 100 + 90 + 100 - W2910 x D80 x H32 mm or	B3900102910	1.938,74
Armature module 100 + 100 + 100 - W3015 x D80 x H32 mm	B3900103015	2.035,70
Bearing arms, 3 pcs., standard or	B39001513	223,97
Bearing arms, 3 pcs., front edge	B39001523	223,97
End covers, 2 pcs.	B390011	97,76

Cable 3 x 1.5 mm², L2500 mm

Item no.	Price EUR
B390013	72,49

Connect fitting



Item no.	Price EUR
B390012	20,88



École Nationale des Ponts et Chaussées (ENPC), Champs sur Marne, France
60/30 Classic round steel shelving

60/30 CLASSIC ROUND STEEL SHELVING

CONFIGURATIONS - WITHOUT SHELVES

Double-sided shelving system with uprights and crossbars. For shelves, see page 168.

Height 92 cm

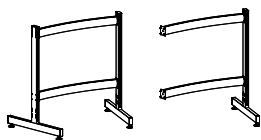
	Degree	Shelf depth cm	Item no. Starter bay	Price EUR	Item no. Add-on bay	Price EUR
	26°	30	BB3031073600	888,96	BB3031173600	736,81
	18°	30	BB3031073800	1.181,84	BB3031173800	1.029,69

Height 122 cm

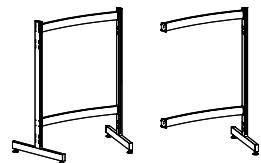
	Degree	Shelf depth cm	Item no. Starter bay	Price EUR	Item no. Add-on bay	Price EUR
	26°	30	BB3031023600	908,38	BB3031123600	746,52
	18°	30	BB3031023800	1.201,26	BB3031123800	1.039,40

Height 152 cm

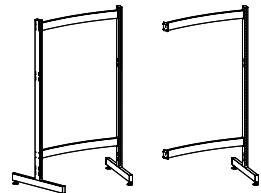
	Degree	Shelf depth cm	Item no. Starter bay	Price EUR	Item no. Add-on bay	Price EUR
	26°	30	BB3031053600	945,62	BB3031153600	765,14
	18°	30	BB3031053800	1.238,50	BB3031153800	1.058,02

Height 182 cm

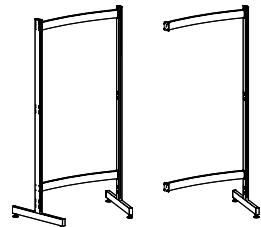
	Degree	Shelf depth cm	Item no. Starter bay	Price EUR	Item no. Add-on bay	Price EUR
	26°	30	BB3031083600	987,38	BB3031183600	786,02
	18°	30	BB3031083800	1.280,26	BB3031183800	1.078,90

Height 212 cm

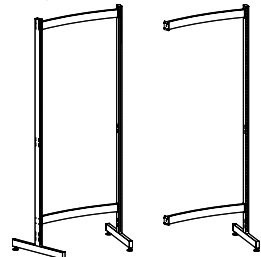
	Degree	Shelf depth cm	Item no. Starter bay	Price EUR	Item no. Add-on bay	Price EUR
	26°	30	BB3031013600	1.029,94	BB3031113600	807,30
	18°	30	BB3031013800	1.322,82	BB3031113800	1.100,18

60/30 CLASSIC ROUND STEEL SHELVING

CONFIGURATIONS - WITH SHELVES - WITHOUT TOP SHELF

Complete double-sided shelving system with uprights, crossbars, shelves, brackets, galvanized safety clip and fittings (the safety clip is available in standard steel colours and can be ordered separately, see page 175). Shelves are rounded steel shelves with backedge. Number of shelves are calculated for optimal shelf spacing for fiction. A starter bay is delivered with one right and one left bracket per shelf. An add-on bay is delivered with a double bracket per shelf, which places the shelves in the same height as that of the starter bay.

Height 92 cm (2 shelves on each side)

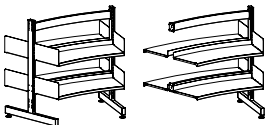
	Degree	Shelf depth cm	Item no. Starter bay	Price EUR	Item no. Add-on bay	Price EUR
	26°	30	BB3031073620	1.962,04	BB3031173620	1.752,93
	18°	30	BB3031073820	2.254,92	BB3031173820	2.045,81

Height 122 cm (3 shelves on each side)

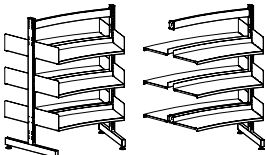
	Degree	Shelf depth cm	Item no. Starter bay	Price EUR	Item no. Add-on bay	Price EUR
	26°	30	BB3031023630	2.518,00	BB3031123630	2.270,70
	18°	30	BB3031023830	2.810,88	BB3031123830	2.563,58

Height 152 cm (4 shelves on each side)

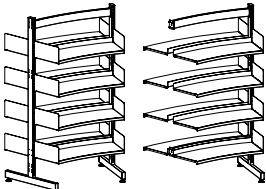
	Degree	Shelf depth cm	Item no. Starter bay	Price EUR	Item no. Add-on bay	Price EUR
	26°	30	BB3031053640	3.091,78	BB3031153640	2.797,38
	18°	30	BB3031053840	3.384,66	BB3031153840	3.090,26

Height 182 cm (5 shelves on each side)

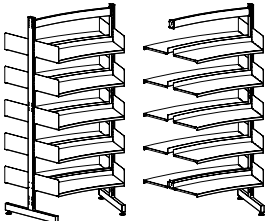
	Degree	Shelf depth cm	Item no. Starter bay	Price EUR	Item no. Add-on bay	Price EUR
	26°	30	BB3031083650	3.670,08	BB3031183650	3.326,32
	18°	30	BB3031083850	3.962,96	BB3031183850	3.619,20

Height 212 cm (6 shelves on each side)

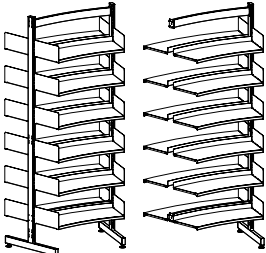
	Degree	Shelf depth cm	Item no. Starter bay	Price EUR	Item no. Add-on bay	Price EUR
	26°	30	BB3031013660	4.249,18	BB3031113660	3.855,66
	18°	30	BB3031013860	4.542,06	BB3031113860	4.148,54

60/30 CLASSIC ROUND STEEL SHELVING

CONFIGURATIONS - WITH SHELVES AND TOP SHELVES

Complete double-sided shelving system with uprights, crossbars, shelves, top shelves, brackets, galvanized safety clip and fittings (the safety clip is available in standard steel colours and can be ordered separately, see page 175). Shelves are rounded steel shelves with backedge, top shelves are steel shelves without backedge. Number of shelves are calculated for optimal shelf spacing for fiction. A starter bay is delivered with one right and one left bracket per shelf. An add-on bay is delivered with a double bracket per shelf, which places the shelves in the same height as that of the starter bay.

Height 92 cm (2 shelves + top shelf on each side)

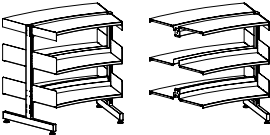
			Degree	Shelf depth cm	Item no. Starter bay	Price EUR	Item no. Add-on bay	Price EUR
	Ø432 cm	26°	30	BB3031073621	2.485,95	BB3031173621	2.248,36	
	Ø600 cm	18°	30	BB3031073821	3.011,18	BB3031173821	2.773,59	

Height 122 cm (3 shelves + top shelf on each side)

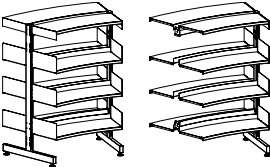
			Degree	Shelf depth cm	Item no. Starter bay	Price EUR	Item no. Add-on bay	Price EUR
	Ø432 cm	26°	30	BB3031023631	3.041,91	BB3031123631	2.766,13	
	Ø600 cm	18°	30	BB3031023831	3.567,14	BB3031123831	3.291,36	

Height 152 cm (4 shelves + top shelf on each side)

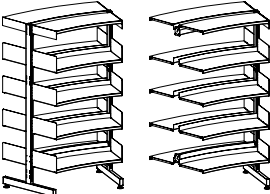
			Degree	Shelf depth cm	Item no. Starter bay	Price EUR	Item no. Add-on bay	Price EUR
	Ø432 cm	26°	30	BB3031053641	3.615,69	BB3031153641	3.292,81	
	Ø600 cm	18°	30	BB3031053841	4.140,92	BB3031153841	3.818,04	

Height 182 cm (5 shelves + top shelf on each side)

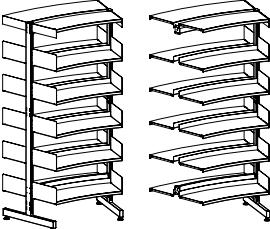
			Degree	Shelf depth cm	Item no. Starter bay	Price EUR	Item no. Add-on bay	Price EUR
	Ø432 cm	26°	30	BB3031083651	4.193,99	BB3031183651	3.821,75	
	Ø600 cm	18°	30	BB3031083851	4.719,22	BB3031183851	4.346,98	

Height 212 cm (6 shelves + top shelf on each side)

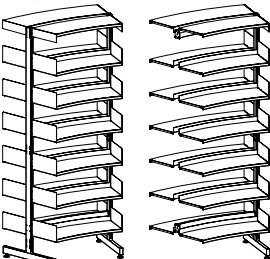
			Degree	Shelf depth cm	Item no. Starter bay	Price EUR	Item no. Add-on bay	Price EUR
	Ø432 cm	26°	30	BB3031013661	4.773,09	BB3031113661	4.351,09	
	Ø600 cm	18°	30	BB3031013861	5.298,32	BB3031113861	4.876,32	

ROUND SHELVES

ROUND STEEL SHELVES

See below for overview of standard round steel shelves:

B301500 - ROUND STEEL SHELF WITH STEEL BACKEDGE - 25 MM FRONTEDGE

Details:

- 26°/18°
- Depth 300 mm
- Steel backedge H47 mm
- Steel plate brackets
- Max. weight 80 kg.

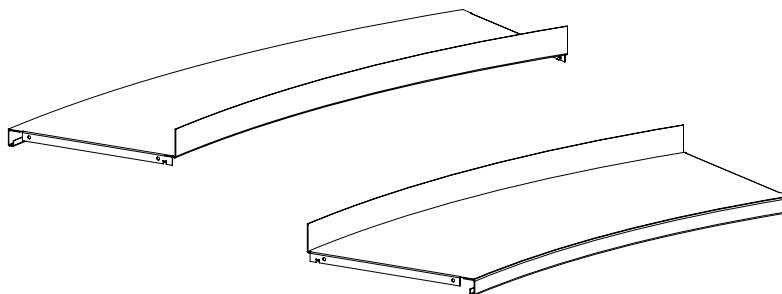

ROUND SHELVES

ROUND SINGLE-SIDED STEEL SHELF

Round steel shelf with steel backedge - with brackets

With one left and one right bracket.

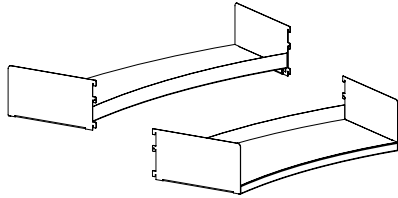

Degree	Shelf depth cm	Item no. Inner	Price EUR	Item no. Outer	Price EUR
26°	30	BB3030561	245,00	BB3030562	276,12
18°	30	BB3030581	245,00	BB3030582	276,12

Round steel shelf with steel backedge - without brackets

Shelves for starter bays must be ordered with left and right brackets. Shelves for add-on bays must be ordered with double bracket.

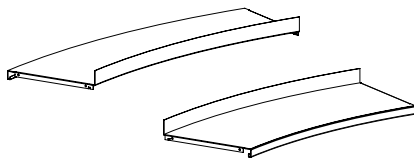

Degree	Shelf depth cm	Item no. Inner	Price EUR	Item no. Outer	Price EUR
26°	30	B301500613	214,40	B301500623	245,52
18°	30	B301500813	214,40	B301500823	245,52

Steel plate bracket for steel shelves with steel backedge

H15 cm.

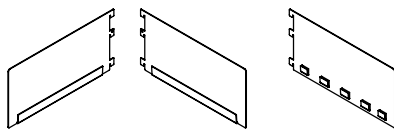

Type	Shelf depth cm	Item no.	Price EUR
Left	30	B30101437	15,30
Right	30	B30101438	15,30
Double	30	B30101439	16,36

ROUND SHELVES

ROUND STEEL TOP SHELVES

See below for overview of standard round steel top shelves:

B301502 - SINGLE-SIDED ROUND STEEL TOP SHELF - 25 MM FRONTEDGE

Details:

- 26°/18°
- Depth 300 mm
- Steel brackets
- Max. weight 25 kg.

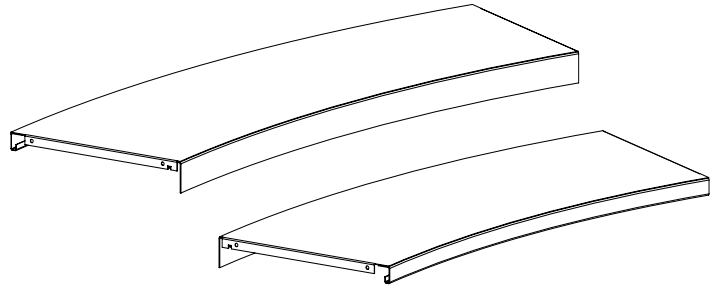

B301531 - DOUBLE-SIDED ROUND STEEL TOP SHELF - 25/47 MM FRONTEDGE

Details:

- 26°/18°
- Depth 660 mm
- Freestanding/outer/intermediate
- Steel brackets
- Max. weight 25 kg.

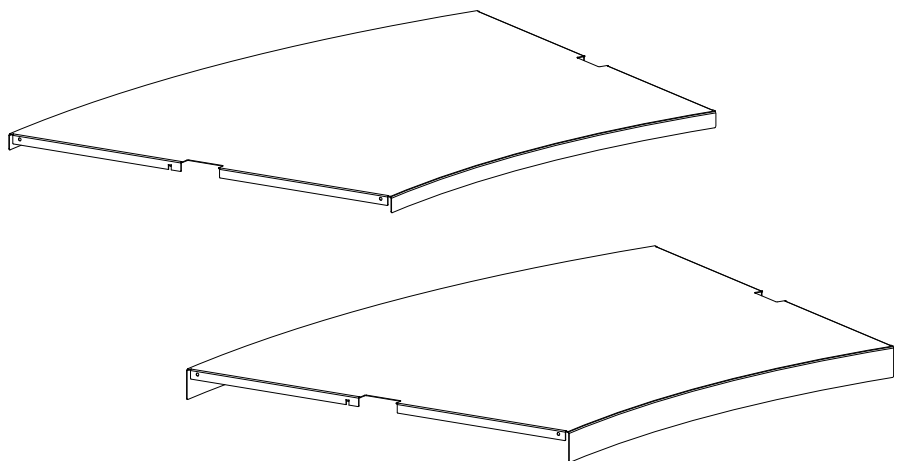

ROUND SHELVES

ROUND SINGLE-SIDED STEEL TOP SHELF

Round single-sided steel top shelf

Order 1 inner and 1 outer shelf per section. Shelves for starter bays must be ordered with left and right brackets. Shelves for add-on bays must be ordered with double bracket.

Degree	Shelf depth cm	Item no. Inner	Price EUR	Item no. Outer	Price EUR
26°	30	B301502613	215,46	B301502623	247,25
18°	30	B301502813	323,32	B301502823	371,74

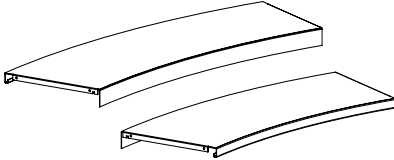

Steel bracket for round single-sided steel shelf

H7.5 cm. Max. load of 25 kg.

Type	Shelf depth cm	Item no.	Price EUR
Left	30	B30102437	15,30
Right	30	B30102438	15,30
Double	30	B30102439	16,36

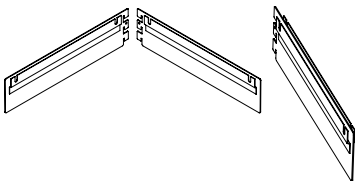

ROUND SHELVES

ROUND DOUBLE-SIDED STEEL TOP SHELF WITH BRACKETS

Double-sided steel top shelf with brackets - for 1 freestanding bay

2 left and 2 right brackets included.

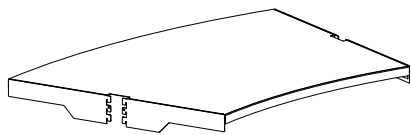
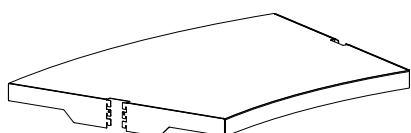
	Degree	Shelf depth cm	Front edge cm	Item no.	Price EUR
	26°	30	25	BB3030765125	
	18°	30	25	BB3030785125	
	26°	30	47	BB3030765147	
	18°	30	47	BB3030785147	

Double-sided steel top shelf with brackets - for 1 left, outer bay

1 left, 1 right and 1 double bracket included.

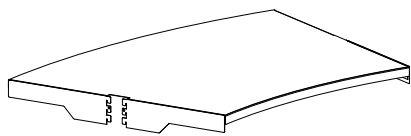
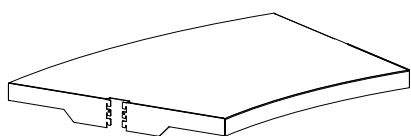
	Degree	Shelf depth cm	Front edge cm	Item no.	Price EUR
	26°	30	25	BB3030761125	
	18°	30	25	BB3030781125	
	26°	30	47	BB3030761147	
	18°	30	47	BB3030781147	

Double-sided steel top shelf with brackets - for 1 intermediate bay

2 double brackets included.

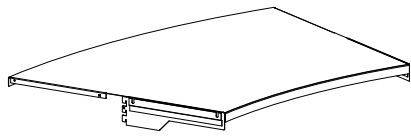
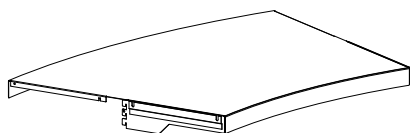
	Degree	Shelf depth cm	Front edge cm	Item no.	Price EUR
	26°	30	25	BB3030763125	
	18°	30	25	BB3030783125	
	26°	30	47	BB3030763147	
	18°	30	47	BB3030783147	

Double-sided steel top shelf with brackets - for 1 right, outer bay

1 left, 1 right and 1 double bracket included.

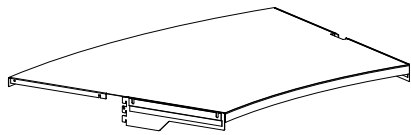
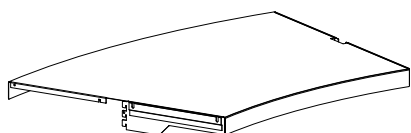
	Degree	Shelf depth cm	Front edge cm	Item no.	Price EUR
	26°	30	25	BB3030762125	
	18°	30	25	BB3030782125	
	26°	30	47	BB3030762147	
	18°	30	47	BB3030782147	

ROUND SHELVES

ROUND DOUBLE-SIDED STEEL TOP SHELF

Double-sided steel top shelf without brackets - for 1 freestanding bay

2 left and 2 right brackets to be ordered separately. See page 175.

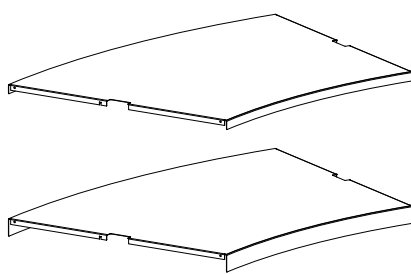

Degree	Shelf depth cm	Front edge cm
26°	30	25
18°	30	25
26°	30	47
18°	30	47

Item no.	Price EUR
B30153165125	
B30153185125	
B30153165147	
B30153185147	

Double-sided steel top shelf without brackets - for 1 left, outer bay

1 left, 1 right and 1 double brackets to be ordered separately. See page 175.

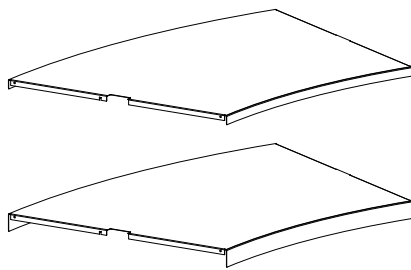

Degree	Shelf depth cm	Front edge cm
26°	30	25
18°	30	25
26°	30	47
18°	30	47

Item no.	Price EUR
B30153161125	
B30153181125	
B30153161147	
B30153181147	

Double-sided steel top shelf without brackets - for 1 intermediate bay

2 double brackets to be ordered separately. See page 175.

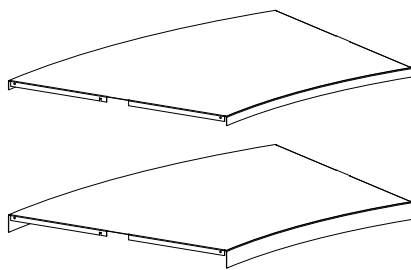

Degree	Shelf depth cm	Front edge cm
26°	30	25
18°	30	25
26°	30	47
18°	30	47

Item no.	Price EUR
B30153163125	
B30153183125	
B30153163147	
B30153183147	

Double-sided steel top shelf without brackets - for 1 right, outer bay

1 left, 1 right and 1 double brackets to be ordered separately. See page 175.

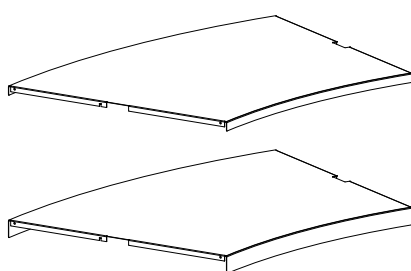

Degree	Shelf depth cm	Front edge cm
26°	30	25
18°	30	25
26°	30	47
18°	30	47

Item no.	Price EUR
B30153162125	
B30153182125	
B30153162147	
B30153182147	



COMPONENTS FOR ROUND STEEL SHELVES

BRACKETS, SHELF STRENGTHENER AND SAFETY CLIPS

Steel bracket for steel top shelf B301531

Max. load of 25 kg.

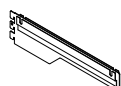
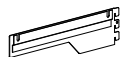

Type	Shelf depth cm	Item no.	Price EUR
Left	30	B30102937	15,30
Right	30	B30102938	15,30
Double	30	B30102939	16,36

Shelf strengthener

Max. load on round shelf is 30 kg.

Max. load on round shelf with shelf strengthener is 80 kg.

Degree	Shelf depth cm	Item no. Inner	Price EUR	Item no. Outer	Price EUR
26°	30	B301540613	43,62	B301540623	52,14
18°	30	B301540813	43,62	B301540823	52,14



Safety clip

Two used per outer shelf. Hooks into the upright to prevent the shelf from possible tipping.

Finish	Item no.	Price EUR
Painted	B301530	7,71

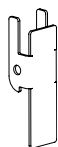

ROUND SHELVES

FSC DOUBLE-SIDED ROUND LONDON WOODEN TOP PLATE

See below for overview of standard round wooden top plate:

B302134 - FSC DOUBLE-SIDED ROUND LONDON WOODEN TOP PLATE - 30 MM FRONTEDGE

Details:

- 26°/18°
- Depth 300 mm
- Steel plate brackets
- Max. weight 25 kg.

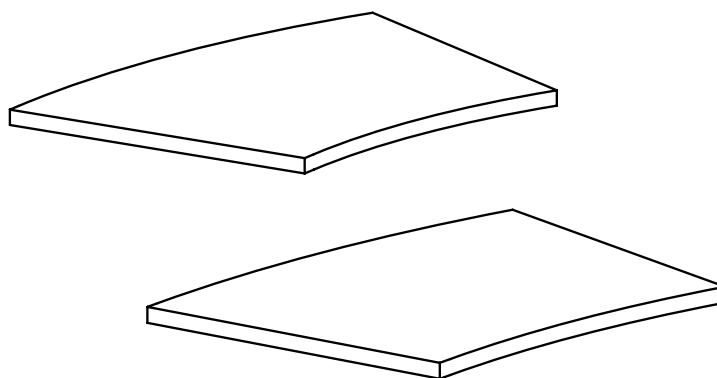

ROUND SHELVES

FSC DOUBLE-SIDED ROUND LONDON WOODEN TOP PLATE

FSC double-sided round London wooden top plate with brackets

D66 cm, 30 mm front edge.
Incl. brackets.

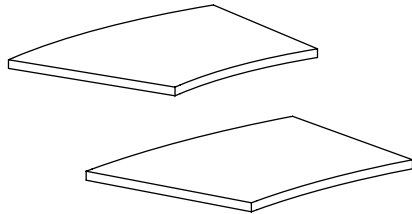

Degree	Type	Item no. 1 bay	Price EUR
26°	Freestanding	B302137365	676,31
18°	Freestanding	B302137385	676,31
26°	Left	B302137361	676,31
18°	Left	B302137381	676,31
26°	Right	B302137362	676,31
18°	Right	B302137382	676,31
26°	Intermediate	B302137363	683,49
18°	Intermediate	B302137383	683,49

Bracket for FSC double-sided London round wooden top plate

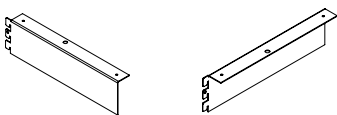

Type	Item no.	Price EUR
Left	B30120038	13,97
Right	B30120039	13,97

COMPONENTS FOR ROUND SHELVING

UPRIGHT AND CROSSBAR

Upright

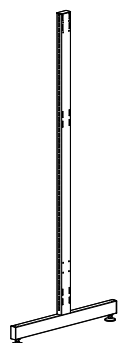

Height cm	Shelf depth cm	Item no.	Price EUR
92	30	B3015197	152,15
122	30	B3015192	161,86
152	30	B3015195	180,48
182	30	B3015198	201,36
212	30	B3015191	222,64

Round crossbar

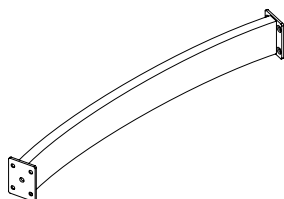

Degree	Shelf depth cm	Item no.	Price EUR
26°	30	B3015106	292,33
18°	30	B3015108	438,77

COMPONENTS FOR ROUND SHELVING

CASTORS AND PLINTHS

Castors

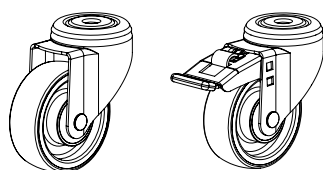

Type	Item no.	Price EUR
Without brakes	B3060000	51,87
With brakes	B3060001	72,22

Round steel plinth

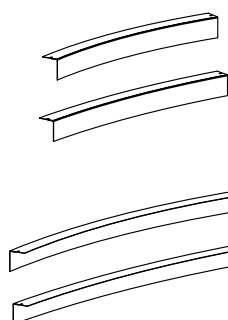

Degree	Curve	Item no.	Price EUR
26°	Inner	B30152761	173,43
18°	Inner	B30152781	173,43
26°	Outer	B30152762	173,43
18°	Outer	B30152782	173,43

Round castor frame set with hidden castors and steel plinth

A set of 2 frames, 4 x Ø35 mm castors without brakes and 2 steel plinths. Fittings included. Holes must be predrilled in the foot of the upright B301519 for installation.

Degree	Item no.	Price EUR
26°	B3015506	569,51
18°	B3015508	569,51

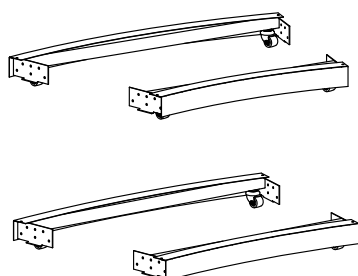



PANELS FOR ROUND SHELVING

WOODEN END PANELS

FSC painted wooden end panel - double-sided

19 mm front edge. Incl. fittings. These end panels are not compatible with hidden castor frames.



Height cm	Shelf depth cm	Item no.	Price EUR
92	30	B3016657395	219,72
122	30	B3016652395	291,27
152	30	B3016655395	354,84
182	30	B3016658395	419,62
199.5	30	B3016659395	472,55
212	30	B3016651395	484,39

FSC veneer wooden end panel - double-sided

19 mm front edge. Incl. fittings. These end panels are not compatible with hidden castor frames.

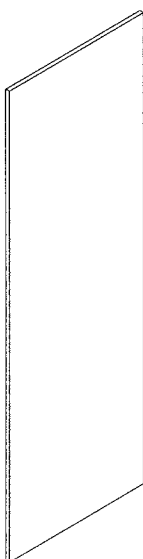

Height cm	Shelf depth cm	Item no.	Price EUR
92	30	B3016657391	307,63
122	30	B3016652391	407,91
152	30	B3016655391	496,76
182	30	B3016658391	587,46
199.5	30	B3016659391	661,54
212	30	B3016651391	678,17

PANELS FOR ROUND SHELVING

WOODEN SLAT END PANELS

FSC painted wooden slat end panel - double-sided

22 mm front edge. Incl. fittings. These end panels are not compatible with hidden castor frames.

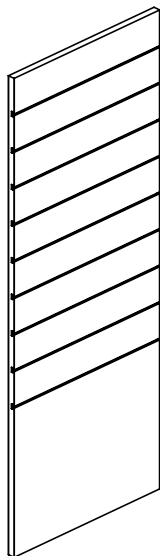

Height cm	Shelf depth cm	Item no.	Price EUR
92	30	B3016747395	307,90
122	30	B3016742395	408,18
152	30	B3016745395	480,66
182	30	B3016748395	529,61
212	30	B3016741395	595,44

FSC veneer wooden slat end panel - double-sided

22 mm front edge. Incl. fittings. These end panels are not compatible with hidden castor frames.

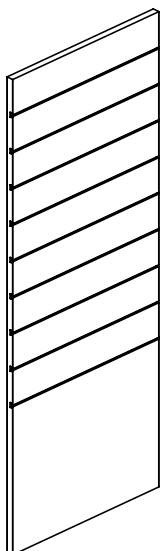

Height cm	Shelf depth cm	Item no.	Price EUR
92	30	B3016747391	431,19
122	30	B3016742391	571,37
152	30	B3016745391	672,98
182	30	B3016748391	741,48
212	30	B3016741391	833,64

PANELS FOR ROUND SHELVING

LONDON WOODEN END PANELS

FSC painted London wooden end panel for steel top shelf - double-sided

30 mm front edge. To be used with steel top shelf, see page 170. Incl. fittings.

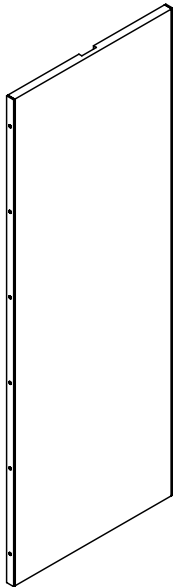

Height cm	Shelf depth cm	Item no.	Price EUR
92	30	B3021257392	385,83
122	30	B3021252392	487,05
152	30	B3021255392	580,15
182	30	B3021258392	673,51
212	30	B3021251392	774,59

FSC painted London wooden end panel for wooden overlaying top plate - double-sided

30 mm front edge. To be used with London wooden overlaying top, see page 176. Incl. fittings.

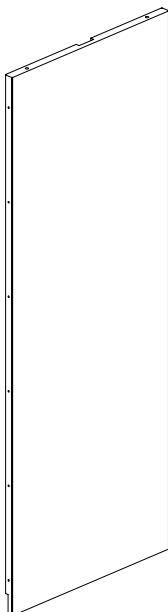

Height cm	Shelf depth cm	Item no.	Price EUR
92	30	B3021257391	385,83
122	30	B3021252391	487,05
152	30	B3021255391	580,15
182	30	B3021258391	673,51
212	30	B3021251391	774,59

PANELS FOR ROUND SHELVING

PERFORATED STEEL END PANEL

Perforated steel end panels - double-sided

45 mm front edge. Two A5 acrylic covers for signage and fittings included.
Hole size Ø4,5 mm.

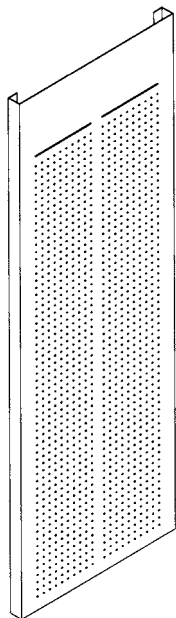

Height cm	Shelf depth cm	Item no.	Price EUR
92	30	B301600739	217,46
122	30	B301600239	228,63
152	30	B301600539	289,28
182	30	B301600839	325,72
199.5	30	B301600939	348,59
212	30	B301600139	364,02

PANELS FOR ROUND SHELVING

FITTINGS FOR PANELS

Fittings for wooden end panel

Type	Heights < 152 cm Item no.	Price EUR	Heights > =152 cm Item no.	Price EUR
Left	B30165227	23,81	B30165217	33,25
Right	B30165228	23,81	B30165218	33,25
Double	B30165229	47,35	B30165219	65,30

Fittings for wooden display end panel

Type	Item no. Heights < 152 cm	Price EUR	Item no. Heights > =152 cm	Price EUR
Left	B30167227	23,81	B30167217	33,25
Right	B30167228	23,81	B30167218	33,25
Double	B30167229	47,35	B30167219	65,30



END PANEL BAYS

FOR ROUND DOUBLE-SIDED 60/30 CLASSIC STEEL SHELVING

The following pages will show basic configurations of end panel bays for double-sided 60/30 Classic Steel Shelving system.



END PANEL BAYS

FOR ROUND DOUBLE-SIDED 60/30 CLASSIC STEEL SHELVING

FSC-approved end panel bay with wooden top shelf, wooden panels, wooden bottom shelf and adjustable feet. For shelves, see page 194.

Height 92 cm

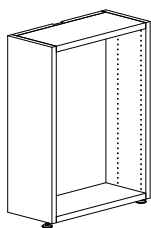

Depth of shelving system - cm	Width of end panel bay - cm	Depth of end panel bay - cm	Item no. Painted	Price EUR	Item no. Veneer	Price EUR
30/30	61,8	25	BB30132722005	1.270,15	BB30132722001	1.778,21
30/30	61,8	30	BB30132723005	1.270,15	BB30132723001	1.778,21

Height 122

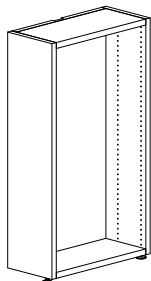

Depth of shelving system - cm	Width of end panel bay - cm	Depth of end panel bay - cm	Item no. Painted	Price EUR	Item no. Veneer	Price EUR
30/30	61,8	25	BB30132222005	1.667,29	BB30132222001	2.334,15
30/30	61,8	30	BB30132223005	1.667,29	BB30132223001	2.334,15

Height 152 cm

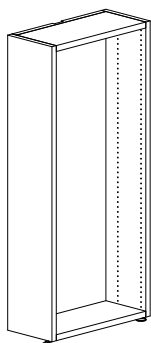

Depth of shelving system - cm	Width of end panel bay - cm	Depth of end panel bay - cm	Item no. Painted	Price EUR	Item no. Veneer	Price EUR
30/30	61,8	25	BB30132522005	2.063,76	BB30132522001	2.889,29
30/30	61,8	30	BB30132523005	2.063,76	BB30132523001	2.889,29

END PANEL BAYS

FOR ROUND DOUBLE-SIDED 60/30 CLASSIC STEEL SHELVING

FSC-approved end panel bay with wooden top shelf, wooden panels, wooden bottom shelf and adjustable feet. For shelves, see page 194.

Height 182 cm

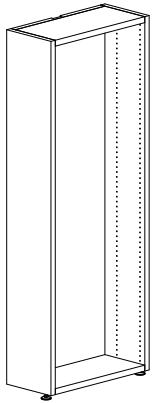

Depth of shelving system - cm	Width of end panel bay - cm	Depth of end panel bay - cm	Item no. Painted	Price EUR	Item no. Veneer	Price EUR
30/30	61,8	25	BB30132822005	2.460,90	BB30132822001	3.445,23
30/30	61,8	30	BB30132823005	2.460,90	BB30132823001	3.445,23

Height 212 cm

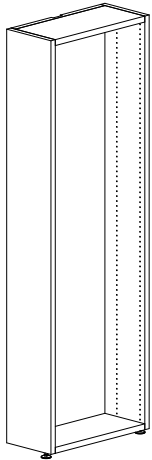

Depth of shelving system - cm	Width of end panel bay - cm	Depth of end panel bay - cm	Item no. Painted	Price EUR	Item no. Veneer	Price EUR
30/30	61,8	25	BB30132122005	2.857,37	BB30132122001	4.000,37
30/30	61,8	30	BB30132123005	2.857,37	BB30132123001	4.000,37

END PANEL BAYS

FOR ROUND DOUBLE-SIDED SHELVING WITH AJDUSTABLE FEET & LONDON WOODEN TOP PLATE

FSC-approved end panel bay with overlaying London wooden top plate, wooden panels, wooden bottom shelf and adjustable feet. For shelves, see page 194.

Height 92 cm

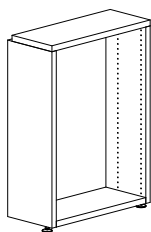

Depth of shelving system - cm	Width of end panel bay - cm	Depth of end panel bay - cm	Item no. Painted	Price EUR	Item no. Veneer	Price EUR
30/30	61,8	25	BB30133722005	1.270,15	BB30133722001	1.778,21
30/30	61,8	30	BB30133723005	1.270,15	BB30133723001	1.778,21

Height 122

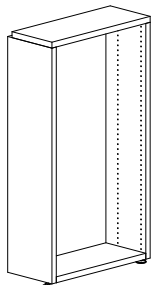

Depth of shelving system - cm	Width of end panel bay - cm	Depth of end panel bay - cm	Item no. Painted	Price EUR	Item no. Veneer	Price EUR
30/30	61,8	25	BB30133222005	1.667,29	BB30133222001	2.334,15
30/30	61,8	30	BB30133223005	1.667,29	BB30133223001	2.334,15

Height 152 cm

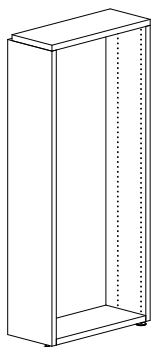

Depth of shelving system - cm	Width of end panel bay - cm	Depth of end panel bay - cm	Item no. Painted	Price EUR	Item no. Veneer	Price EUR
30/30	61,8	25	BB30133522005	2.063,76	BB30133522001	2.889,29
30/30	61,8	30	BB30133523005	2.063,76	BB30133523001	2.889,29

END PANEL BAYS

FOR ROUND DOUBLE-SIDED SHELVING WITH ADJUSTABLE FEET & LONDON WOODEN TOP PLATE

FSC-approved end panel bay with overlaying London wooden top plate, wooden panels, wooden bottom shelf and adjustable feet. For shelves, see page 194.

Height 182 cm

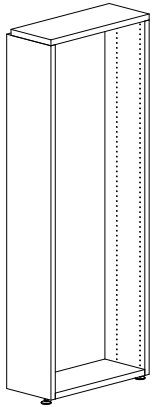

Depth of shelving system - cm	Width of end panel bay - cm	Depth of end panel bay - cm	Item no. Painted	Price EUR	Item no. Veneer	Price EUR
30/30	61,8	25	BB30133822005	2.460,90	BB30133822001	3.445,23
30/30	61,8	30	BB30133823005	2.460,90	BB30133823001	3.445,23

Height 212 cm

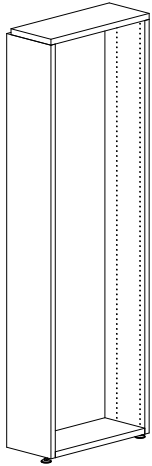

Depth of shelving system - cm	Width of end panel bay - cm	Depth of end panel bay - cm	Item no. Painted	Price EUR	Item no. Veneer	Price EUR
30/30	61,8	25	BB30133122005	2.857,37	BB30133122001	4.000,37
30/30	61,8	30	BB30133123005	2.857,37	BB30133123001	4.000,37

END PANEL BAYS

FOR ROUND DOUBLE-SIDED SHELVING WITH CASTORS

FSC-approved end panel bay with wooden top shelf, wooden panels, wooden bottom shelf and castors. For shelves, see page 194.

Height 92 cm

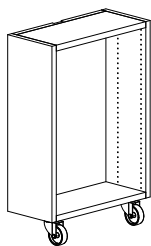

Depth of shelving system - cm	Width of end panel bay - cm	Depth of end panel bay - cm	Item no. Painted	Price EUR	Item no. Veneer	Price EUR
30/30	61,8	25	BB30136722005	1.373,89	BB30136722001	1.923,45
30/30	61,8	30	BB30136723005	1.373,89	BB30136723001	1.923,45

Height 122

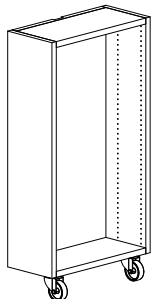

Depth of shelving system - cm	Width of end panel bay - cm	Depth of end panel bay - cm	Item no. Painted	Price EUR	Item no. Veneer	Price EUR
30/30	61,8	25	BB30136222005	1.771,03	BB30136222001	2.479,39
30/30	61,8	30	BB30136223005	1.771,03	BB30136223001	2.479,39

Height 152 cm

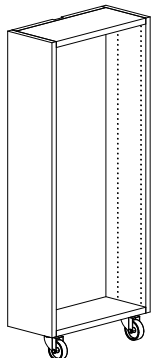

Depth of shelving system - cm	Width of end panel bay - cm	Depth of end panel bay - cm	Item no. Painted	Price EUR	Item no. Veneer	Price EUR
30/30	61,8	25	BB30136522005	2.167,50	BB30136522001	3.034,53
30/30	61,8	30	BB30136523005	2.167,50	BB30136523001	3.034,53

END PANEL BAYS

FOR ROUND DOUBLE-SIDED SHELVING WITH CASTORS & LONDON WOODEN TOP PLATE

FSC-approved end panel bay with overlaying London wooden top plate, wooden panels, wooden bottom shelf and castors. For shelves, see page 194.

Height 92 cm

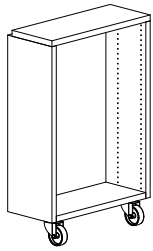

Depth of shelving system - cm	Width of end panel bay - cm	Depth of end panel bay - cm	Item no. Painted	Price EUR	Item no. Veneer	Price EUR
30/30	61,8	25	BB30137222005	1.771,03	BB30137222001	2.479,39
30/30	61,8	30	BB30137223005	1.771,03	BB30137223001	2.479,39

Height 122

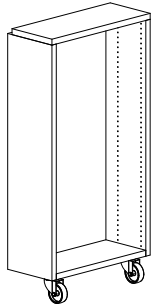

Depth of shelving system - cm	Width of end panel bay - cm	Depth of end panel bay - cm	Item no. Painted	Price EUR	Item no. Veneer	Price EUR
30/30	61,8	25	BB30137522005	2.167,50	BB30137522001	3.034,53
30/30	61,8	30	BB30137523005	2.167,50	BB30137523001	3.034,53

Height 152 cm

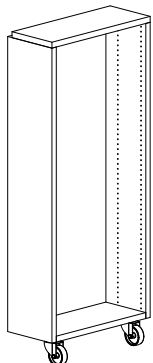

Depth of shelving system - cm	Width of end panel bay - cm	Depth of end panel bay - cm	Item no. Painted	Price EUR	Item no. Veneer	Price EUR
30/30	61,8	25	BB30137722005	1.373,89	BB30137722001	1.923,45
30/30	61,8	30	BB30137723005	1.373,89	BB30137723001	1.923,45

END PANEL BAYS

STEEL SHELVES

Steel shelf with steel backedge for backedge book support

Steel backedge 47 mm. Brackets must be ordered separately.	Depth of shelving system - cm	Depth of end panel bay - cm	Width of shelf - cm	Item no.	Price EUR
	30/30	25	61,3	B30118222	77,14
	30/30	30	61,3	B30118223	77,14

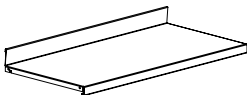

Bracket for steel shelves with steel backedge

* Can be used for D25 and 30 cm shelves.

Type	Depth of end panel bay - cm	Item no.	Price EUR
Left	25	B78300128	17,82
Right	25	B78300129	17,82
Left*	30	B78300138	17,82
Right*	30	B78300139	17,82

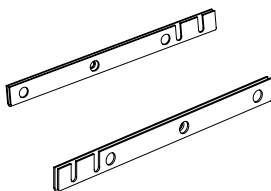

45°/60° sloping steel shelf

With fittings.	Depth of shelving system - cm	Depth of end panel bay - cm	Item no.	Price EUR
	30/30	25	B30118622	73,28
	30/30	30	B30118623	73,28





LOCATIONS

WE ARE LIBRARY PEOPLE®



DENMARK

Lammhults Biblioteksdesign A/S
Dalbækvej 1
6670 Holsted

bci@bci.dk
www.bci.dk

FRANCE

BC Intérieur Sarl
6 allée Kepler
77420 Champs sur Marne

bci@bcinterieur.com
www.bcinterieur.com

BELGIUM

SBNL - Schulz Benelux BVBA
Appelweg 94 C
3221 Holsbeek

info@sbnl.be
www.sbnl.be

SWEDEN

Lammhults Biblioteksdesign AB
Odlarevägen 16
226 60 Lund

eurobib@eurobib.se
www.eurobib.se

GERMANY

Schulz Speyer Bibliothekstechnik AG
Hafenstraße 2
67346 Speyer

sales@schulzspeyer.de
www.schulzspeyer.de

UNITED KINGDOM

thedesignconcept Ltd.
The Old Bakery,
10 Greenless Road
Cambuslang Belgrave Street
Glasgow G72 8JJ

info@thedesignconcept.co.uk
www.thedesignconcept.co.uk

NORWAY

BS Eurobib AS
Alf Bjerckes Vei 20
0582 Oslo

post@bseurobib.no
www.bseurobib.no