



# 60/30 CLASSIC

DKK PRICE LIST

01.01.2024



# 60/30 CLASSIC STEEL SHELVING

The 60/30 Classic Steel Shelving system is the essence of many years of experience and success. This flexible product concept has evolved over the years and the modular structure and the large number of standard components ensure ideal room utilization and rational accommodation of all relevant functions. In addition the flexibility of the system allows a variety of individual solutions which our design teams bring to life for the individual library.

You will find all our standard products in this overview. For additional inspiration we invite you to visit our website, where you can find project inspiration from our latest projects around the world.

The 60/30 Classic Steel Shelving system is shown in many creative configurations mixed with special developments such as round shelving with seating benches and castors, integrated youth corners with tables and chairs etc. Our broad portfolio of library furniture provides endless possibilities. Please contact our professional sales teams for inspiration.



The price list is valid from 01.01.2024 until 31.12.2024.

## Conditions of sale and terms of delivery

All prices excluding VAT and delivery. Please see our conditions of sale and terms of delivery on our website.

## Updating the price list

The price list will continually be updated and can be downloaded on our website. Please contact our sales office, who will forward a log-in and password via e-mail. We reserve the right to make product and price alterations without prior notice and accept no liability for printing errors.

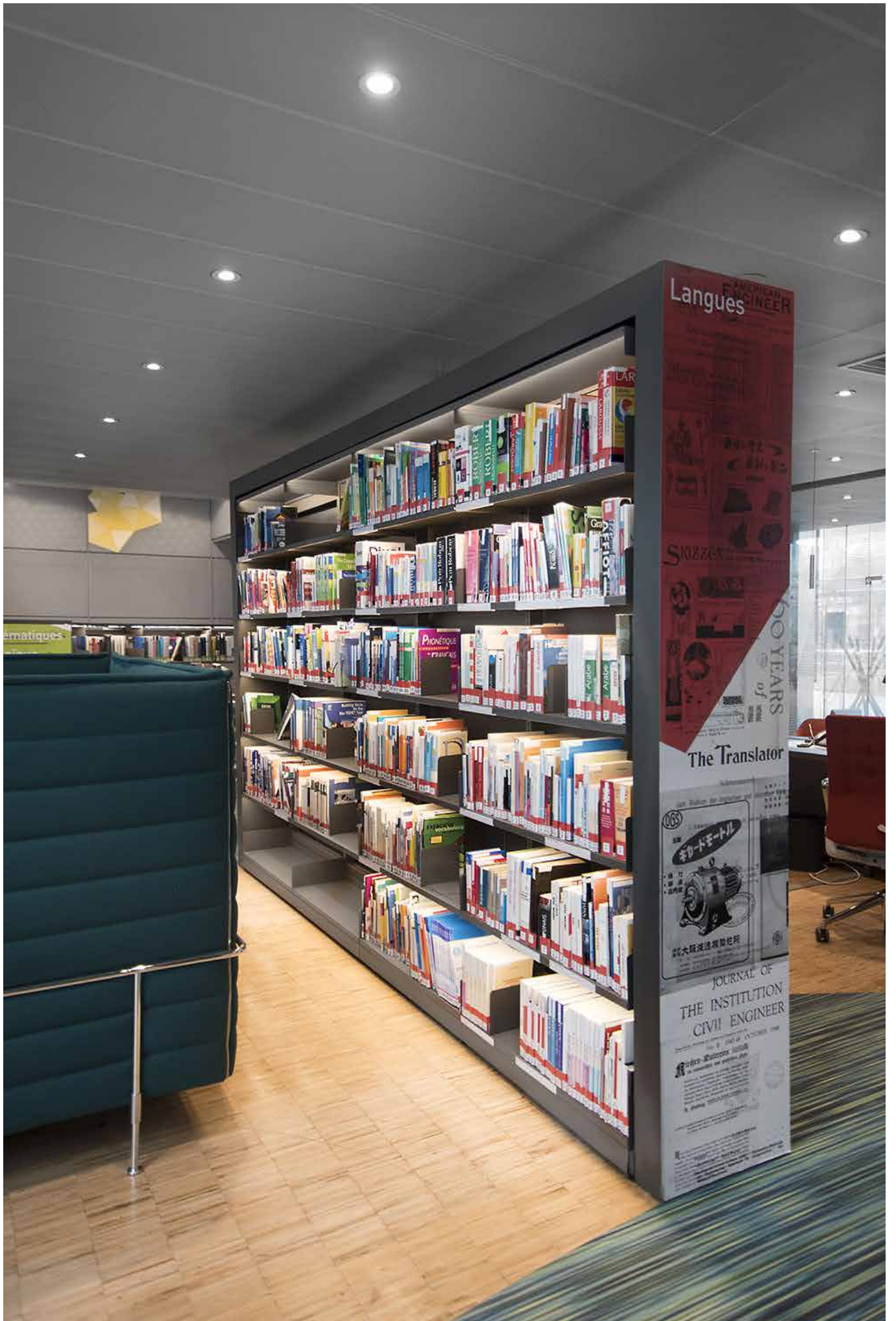

# INDEX

<b>FSC</b> .....	6
<b>DESIGN OPTIONS</b> .....	9
<b>TECHNICAL SPECIFICATIONS</b> .....	12
<b>DIMENSIONS</b> .....	16

## STRAIGHT CONFIGURATIONS

<b>60/30 CLASSIC STEEL SHELVING</b> .....	26
Single-sided configurations without shelves .....	28
Double-sided configurations without shelves .....	30
Single-sided configurations without top shelf .....	32
Double-sided configurations without top shelf .....	34
Single-sided configurations with top shelf .....	36
Double-sided configurations with top shelf .....	38
<b>60/30 CLASSIC STEEL SHELVING WITH LED</b> .....	40
Single-sided configurations without top shelf .....	42
Double-sided configurations without top shelf .....	44
Single-sided configurations with top shelf .....	46
Double-sided configurations with top shelf .....	48
<b>80/30 CLASSIC STEEL SHELVING</b> .....	50
Single-sided configurations .....	52
Double-sided configurations .....	53
<b>60/30 CLASSIC STEEL SHELVING - WALL</b> .....	54
Single-sided configurations .....	56
<b>60/30 EXPO</b> .....	58
Double-sided configurations - H122 cm .....	60
Double-sided configurations - H152 cm .....	63

## COMPONENTS FOR STRAIGHT SHELVING

<b>SHELVES</b>	
Steel shelves .....	66
Steel top shelves and London top plates .....	74
Wooden shelves .....	102
Wooden top shelves and London top plates .....	104
Accessories for shelves .....	113
<b>ACCESSORIES</b>	
Book supports .....	114
Browsers .....	116
Display & storage - magazines .....	121
Display & storage - multimedia .....	125
Display & storage - for shelves .....	126
Display & storage - for slat end panels .....	128
Display & storage - for perforated end panels .....	129
Signage - for end panels/uprights/tops .....	131
Signage - for shelves .....	132
<b>UPRIGHTS &amp; CROSSBARS</b>	
Uprights for 60/30 Classic .....	134
Uprights for 80/30 Classic .....	135
Wall strips for 60/30 Classic .....	136
Uprights, frame and castor set for hidden castors .....	137
Upright extensions & crossbars .....	138
<b>CASTORS &amp; PLINTHS</b>	
Plinths & castors .....	139
<b>PANELS</b>	
Wooden end panels .....	140
Wooden slat end panels .....	142
Wooden London end panel .....	144
Perforated steel end panels .....	146
Steel London end panels .....	147
Glass end panels .....	148
Back panels .....	149
<b>END PANEL BAYS</b>	
End panel bay with adjustable feet .....	152
End panel bay with adjustable feet and London top .....	154
End panel bay with castors .....	156
End panel bay with castors and London top .....	157
Steel shelves for end panel bays .....	158
<b>LIGHTING</b>	
LED lighting .....	160
Book LED lighting .....	162

DKK

## ROUND CONFIGURATIONS

<b>60/30 ROUND STEEL SHELVING</b> .....	164
Double-sided configurations without shelves .....	165
Double-sided configurations without top shelf .....	166
Double-sided configurations with top shelf .....	167

## COMPONENTS FOR ROUND SHELVING

<b>SHELVES</b>	
Steel shelves .....	168
Steel top shelves .....	170
Wooden London top plates .....	176
Components for shelves .....	177

<b>UPRIGHTS &amp; CROSSBARS</b>	
Uprights for 60/30 Classic Round .....	178
Crossbars .....	178

<b>CASTORS &amp; PLINTHS</b>	
Plinths & castors .....	179

<b>PANELS</b>	
Wooden end panels .....	181
Wooden slat end panels .....	182
Wooden London end panels .....	183
Perforated steel end panels .....	184

<b>END PANEL BAYS</b>	
End panel bay with adjustable feet .....	188
End panel bay with adjustable feet and London top .....	190
End panel bay with castors .....	192
End panel bay with castors and London top .....	193
Steel shelves for end panel bays .....	194



## WOOD FROM SUSTAINABLE MANAGED FORESTRY

**We are committed to increasing the share of sustainable raw wooden material in our products and thereby support responsibly managed forests – for a better world.**

Governments and local authorities are specifying the supply of legal and responsibly sourced wood in their procurement policies.

We have invested in a Chain-of-Custody Multi-site certificate (FSC-C 144988), issued by FSC®, which documents, that we can offer wood from responsibly managed forests. FSC (Forest Stewardship Council) is an international labeling scheme, that documents that FSC labelled products originate from sustainable forestry.

Working with certified suppliers, we can now offer all painted and veneered components as fully FSC Mix certified (noted in this document for each wooden product, which is FSC-certified).



### **What is sustainable managed forestry?**

According to the FSC, forests, managed according to their principles and criteria, mean fair conditions for workers, respect for indigenous communities and local populations as well as strict environmental controls.

The FSC label guarantees that the trees that are harvested are replaced or allowed to regenerate naturally.

The FSC label also guarantees that all the wood is tracked from the forest to the store. Every link between the forest and the consumer is certified to make it clearly identifiable which wood is from sustainable forestry and which is not.

Source: Forest Stewardship Council  
<http://www.fsc-uk.org/en-uk>







# DESIGN OPTIONS

STEEL COMPONENTS - PAINTED

## A PRICE GROUP - BASIS PRICE (smooth finish)



**A03**  
**Traffic white**  
RAL 9016  
Gloss 75-90



**A02**  
**Oyster white**  
RAL 1013  
Gloss 40-50

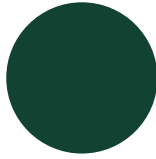

**A22**  
**Moss green**  
RAL 6005  
Gloss 71-85

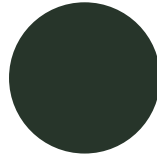

**A26**  
**Fir green**  
RAL 6009  
Gloss 71-85

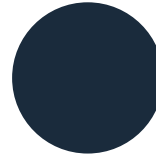

**A12**  
**Steel blue**  
RAL 5011  
Gloss 71-85

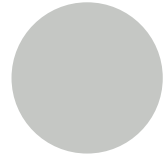

**A13**  
**Light grey**  
RAL 7035  
Gloss 71-85

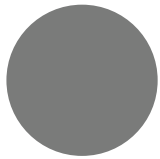

**A15**  
**Dusty grey**  
RAL 7037  
Gloss 71-85

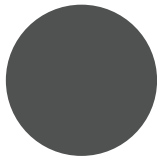

**A16**  
**Traffic grey**  
RAL 7043  
Gloss 71-85

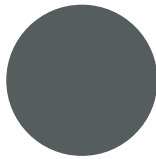

**A17**  
**Basalt grey**  
RAL 7012  
Gloss 71-85

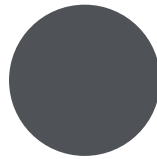

**A18**  
**Slate grey**  
RAL 7015  
Gloss 71-85

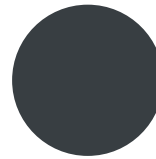

**A19**  
**Anthracite grey**  
RAL 7016  
Gloss 71-85

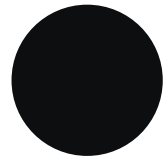

**A25**  
**Jet black**  
RAL 9005  
Gloss 71-85

## B PRICE GROUP - BASIS PRICE WITH 7% SURCHARGE (smooth finish)



**A01**  
**Pure white**  
RAL 9010  
Gloss 71-85



**A04**  
**Traffic yellow**  
RAL 1023  
Gloss 71-85

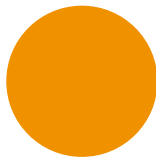

**A05**  
**Sun yellow**  
RAL 1037  
Gloss 71-85

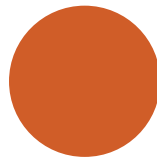

**A06**  
**Signal orange**  
RAL 2010  
Gloss 71-85

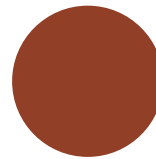

**A07**  
**Pearl orange**  
RAL 2013  
Gloss 65-85

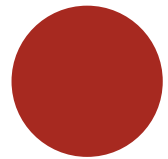

**A08**  
**Flame red**  
RAL 3000  
Gloss 71-85

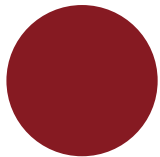

**A09**  
**Ruby red**  
RAL 3003  
Gloss 71-85



**A21**  
**Reseda green**  
RAL 6011  
Gloss 71-85

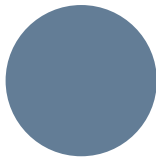

**A10**  
**Pigeon blue**  
RAL 5014  
Gloss 71-85

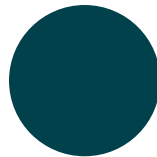

**A11**  
**Ocean blue**  
RAL 5020  
Gloss 71-85

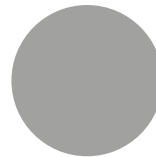

**A14**  
**White aluminium**  
RAL 9006  
Gloss 50-70

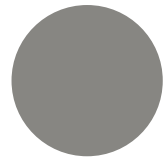

**A31**  
**Grey aluminium**  
RAL 9007  
Gloss 50-70

## B PRICE GROUP - BASIS PRICE WITH 7% SURCHARGE (textured finish)



**A27**  
**Pure white**  
RAL 9010

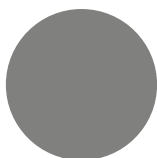

**A29**  
**Concertina grey**

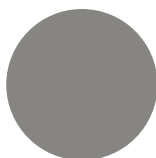

**A28**  
**Grey aluminium**  
RAL 9007



**A23**  
**Anthracite grey**  
RAL 7016

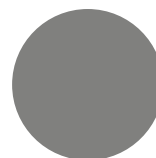

**A24**  
**Graphite black**  
RAL 9011

### Note:

- Other RAL/NCS colours have a starter fee of GBP 215 / EUR 250 and a surcharge of 15%. A higher surcharge for colours with "metallic" look or different surface textures must be expected.
- See specific colour for steel gloss specification. Special requests outside specified gloss range are not covered by the above surcharges.
- Chrome, electro galvanised and aluminium parts are not available in other colours.
- Products such as e.g. castors and accurides cannot be produced in other colours than described in the price list.

# DESIGN OPTIONS

## WOODEN COMPONENTS - PAINTED

### A PRICE GROUP - BASIS PRICE

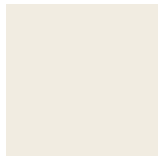

**A01**  
**Pure white**  
RAL 9010  
Gloss 20-30



**A02**  
**Oyster white**  
RAL 1013  
Gloss 20-30

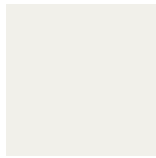

**A03**  
**Traffic white**  
RAL 9016  
Gloss 20-30



**A04**  
**Traffic yellow**  
RAL 1023  
Gloss 20-30



**A05**  
**Sun yellow**  
RAL 1037  
Gloss 20-30



**A06**  
**Signal orange**  
RAL 2010  
Gloss 20-30



**A07**  
**Pearl orange**  
RAL 2013  
Gloss 20-30



**A08**  
**Flame red**  
RAL 3000  
Gloss 20-30



**A09**  
**Ruby red**  
RAL 3003  
Gloss 20-30



**A21**  
**Reseda green**  
RAL 6011  
Gloss 20-30



**A22**  
**Moss green**  
RAL 6005  
Gloss 20-30



**A26**  
**Fir green**  
RAL 6009  
Gloss 20-30



**A10**  
**Pigeon blue**  
RAL 5014  
Gloss 20-30



**A11**  
**Ocean blue**  
RAL 5020  
Gloss 20-30



**A12**  
**Steel blue**  
RAL 5011  
Gloss 20-30



**A13**  
**Light grey**  
RAL 7035  
Gloss 20-30



**A14**  
**White aluminium**  
RAL 9006  
Gloss 20-30



**A31**  
**Grey aluminium**  
RAL 9007  
Gloss 20-30



**A15**  
**Dusty grey**  
RAL 7037  
Gloss 20-30



**A16**  
**Traffic grey**  
RAL 7043  
Gloss 20-30



**A17**  
**Basalt grey**  
RAL 7012  
Gloss 20-30



**A18**  
**Slate grey**  
RAL 7015  
Gloss 20-30



**A19**  
**Anthracite grey**  
RAL 7016  
Gloss 20-30



**A25**  
**Jet black**  
RAL 9005  
Gloss 20-30

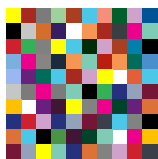

**Any RAL/NCS colour**  
Gloss 20-30

#### Note:

- The above selection of colours match our steel colours. Note that you can order any RAL/NCS colour without surcharge.
- A surcharge for colours with "metallic" look or different surface textures must be expected, please contact Customer Service.

# DESIGN OPTIONS

WOODEN COMPONENTS - VENEER

## **A** PRICE GROUP - BASIS PRICE



**55**  
Light steamed  
beech



**66**  
Oak



**67**  
Maple



**68**  
Ash



**69**  
Birch

### **Note:**

- The wooden veneers can also be stained for a surcharge, please contact Customer Service. Samples will be forwarded for approval.

# TECHNICAL SPECIFICATIONS

## GENERAL SPECIFICATIONS

### **DIMENSIONS**

Dimensions of complete bays in available modules and heights can be found in each catalogue section which include complete configurations. See index page for overview.

### **MOUNTING TOLERANCES**

The tolerances of the increments of the column limit the number of shelving bays, which can be built together. Generally the tolerances permit up to 10 successive bays. Above 10 bays it is advised to continue with a starter bay.

### **MAXIMUM LOAD**

Steel top shelf - max. load of 25 kg.

Steel shelf with backedge - max. load of 80 kg.

Round steel top shelf - max. load of 25 kg.

Round steel shelf with backedge - max. load of 30 kg.

Round steel shelf with backedge and shelf strengthener - max. load of 80 kg.

Wooden top shelf - particleboard - max. load of 25 kg.

Wooden shelf with backedge - block board - max. load of 80 kg.

Steel browser with pull-out frame - max. load of 40 kg

### **MOBILE SHELVINGS/CASTORS**

Only double-sided shelving units with a max. height of 152 cm and maximum 3 bays can be mounted with castors. Castors are available with or without brakes. Max. load of 120 kg per castor, max. load of 100 kg per hidden castor.

### **EXTENSIONS FOR UPRIGHTS**

are used to increase the capacity. Enables an extra layer of shelves. Available for single- and double-sided uprights. Can be used for uprights of max. height of 229 cm.

### **STABILITY**

All uprights are provided with adjustable feet that can be adjusted even when the system is loaded. Single-sided uprights are supplied with anti-topple brackets.

### **ROUNDED EDGES**

All storage units and brackets have rounded edges.

### **BROWSERS**

It is important to remember the following, when installing browsers in a shelving system:

- Browsers without tubes are meant for low medias with a maximum height of 20 cm, meaning they are not suited for e.g. picture books, as they may tip over the edge. If you wish to use store/display tall medias in browsers, then it is recommended to use single browsers with tubes, 20 cm in height and to place the books as far back as possible.
- The foot of the upright must minimally be the same depth as the browser, meaning that a 30 cm deep browser must only be installed on a 30 or 40 cm deep upright and a 40 cm deep browser on a 40 cm deep upright.
- We recommend that all shelving systems with browsers are either fixed to the floor or wall.
- Ensure that children do not play/crawl/hang on the shelving system.
- The maximum weight for each pull-out browser is 45 kg.

### **ASSEMBLY**

No special fittings or tools are needed.

# TECHNICAL SPECIFICATIONS

## STEEL COMPONENTS

### STEEL COMPONENTS

are powder coated with standard polyester based powders that secures high UV resistance. Powders comply with EN 45545 (fire protection - similar to DIN 4201). Thickness of the coating is 60-80 my. The powder used includes no triglycidylisocyanurate (TGIC), no heavy metal-containing pigments such as lead and cadmium and no volatiles

Steel components are not treated with any biocidal products.

Antibacterial equipping of surfaces upon request.

### STEEL UPRIGHTS

are made of steel square tubes. The freestanding single- and double-faced uprights are available in two strengths which are recommended based on load carrying requirements. Choose between configurations with either 60 x 30 mm or 80 x 30 mm external dimensions. The upright is 2 mm thick and the welded foot is 3 mm thick. The uprights allow a wide range of shelves and other functions to be mounted in a row of punched holes with a distance of 25 mm. The uprights are provided with plastic caps to close the tube ends. The uprights are also provided with adjustable feet, adjustable to a max. of 25 mm.

### STEEL WALL STRIPS

are made of 2 mm steel coils. The uprights allow a wide range of shelves and other functions to be mounted in a row of punched holes with a distance of 25 mm.

### STEEL CROSSBARS

are made of 1.4 mm sheet steel. The crossbars are with hooks for easy connection to uprights. The uprights are connected with 2 crossbars for each bay. The top and bottom crossbar have an opening/groove to allow back panels to be fitted to the uprights without the use of special fittings or tools. A third crossbar is used on first and every third 229 and 259 cm high shelving bay. For heavy load it is recommended to use 3 crossbars in each bay. The third crossbar will be mounted at a fixed position using the slots at height 98 cm above the floor.

### STEEL CROSSBARS FOR ROUND SHELVING

are made of 20 x 70 x 2 mm steel square tubes. The crossbars are with connection fittings for easy connection to uprights. The uprights are connected with 2 crossbars for each bay.

### STEEL BRACKETS

are made of 1.4 mm sheet steel.

### STEEL SHELVES/BROWSERS/CABINETS/PULL-OUT SHELVES

are made of 0.9 mm sheet steel. The flat steel shelves have a 25 mm high front edge. The sloping steel shelves are bent in a way so they have a stopper to prevent magazines from sliding off. Flat steel shelves can be mounted in a sloping position by changing brackets.

### STEEL PLINTHS

are 60 mm high and made of 0.9 mm sheet steel.

### LONDON STEEL PLINTHS

are made of 0.9 mm sheet steel over 1 and 2 bays and 1.5 mm sheet steel over 3 bays.

### PERFORATED STEEL END PANELS

are made of 1.4 mm sheet steel. The perforations are Ø4.5 mm.

### LONDON STEEL END PANELS AND TOPS

are made of 1.4 mm sheet steel with a 30 mm wide front edge.

# TECHNICAL SPECIFICATIONS

## WOODEN COMPONENTS

### DENSITY

Particle board has a density of 600-700 kg/m<sup>3</sup>

Block board has a density of 602 m<sup>3</sup> (+/- 2 %)

MDF has a density of 700 kg/m<sup>3</sup> (+/- 5-7 %)

### PAINTED WOODEN COMPONENTS

are made of MDF (medium density fibre board) which is painted with acid lacquer. Standard components have gloss 20 - 30, except for shelves for Expo that have gloss 60 - 70.

#### PAINTED PANELS

are made of 19 mm MDF. The wooden panels are supplied with fittings and hooks for easy connection to uprights.

#### PAINTED DISPLAY PANELS

are made of 22 mm MDF. The wooden panels are supplied with fittings with hooks for easy connection to uprights.

#### PAINTED LONDON WOODEN PANELS AND TOPS

are made of 30 mm MDF. Along the vertical edges of the panel a flat aluminium profile is attached. The aluminium profile is powder coated in the specified colour. The profiles are mounted on the front edge of panels using visible euro screws which are powder coated in the specified colour. The end panels and top are attached to the shelving using steel brackets.

#### PAINTED BACK PANELS

are made of 12 mm MDF.

#### PAINTED TOP SHELVES

are made of 22 mm MDF.

#### PAINTED SHELVES EXPO

are made of 22 mm MDF with special PU paint to increase robustness.

## VENEERED WOODEN COMPONENTS

are mainly lacquered with UV-lacquer.

### VENEERED PANELS

are made of 19 mm particleboard and are veneered with 0.6 mm veneer. All vertical and horizontal edges have a 2 mm veneer edge. The wooden panels are supplied with fittings and hooks for easy connection to uprights.

### VENEERED DISPLAY PANELS

are made of 22 mm MDF and are veneered with 0.6 mm veneer. All vertical and horizontal edges have a 2 mm veneer edge. The wooden panels are supplied with fittings with hooks for easy connection to uprights.

### VENEERED BACK PANELS

are made of 12 mm particleboard and are veneered with 0.6 mm veneer.

### VENEERED SHELVES

are made of 22 mm block board and are veneered with 0.6 mm veneer. The front and back edges have a 2 mm veneer edge.

### VENEERED TOP SHELVES

are made of 22 mm particleboard and are veneered with 0.6 mm veneer. The front and back edges have a 2 mm veneer edge.

### VENEERED CORNER SHELVES

are made of 22 mm particleboard and are veneered with 0.6 mm veneer. The straight edges have a 2 mm veneer edge and the front has a 1 mm wooden edge strip.

# TECHNICAL SPECIFICATIONS

## GLASS COMPONENTS

### **GLASS COMPONENTS**

#### **GLASS END PANELS**

are made of hardened frosted glass. Satimat 10 mm with straight mat facet edges.

# DIMENSIONS

## 60/30 CLASSIC

Please find important dimensions below, configurations can be found on page 26.

### HEIGHTS

The shelving system is available in 5 heights; 92, 122, 152, 182 and 212 cm. Heights include adjustable feet (max. 2.5 cm). The shelves are adjustable in 2.5 cm increments.

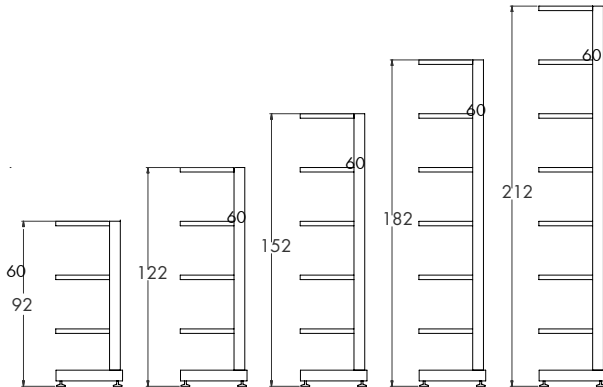

### WIDTHS

The bays are available as starter and add-on bays. A starter bay has two uprights and an add-on bay has one upright.

78 cm is shown as module 75 in price list  
93 cm is shown as module 90 in price list  
103.5 is shown as module 100 in price list\*

Module 75, 90 and 100 indicate distance from centre to centre of uprights.

\*The exact measure of module 100 is 100.5 cm

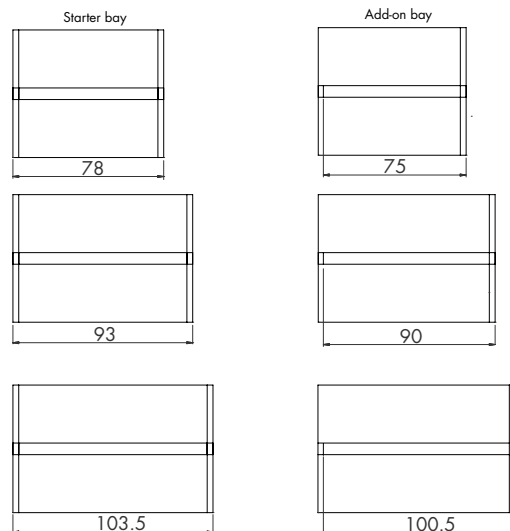

### DEPTHS

The uprights are available in 4 depths:

- 30 cm for 22.5 cm deep shelves
- 32 cm for 25 cm deep shelves
- 37 cm for 30 cm deep shelves
- 47 cm for 40 cm deep shelves

- 51 cm for 2 x 22.5 cm deep shelves
- 56 cm for 2 x 25 cm deep shelves
- 66 cm for 2 x 30 cm deep shelves
- 86 cm for 2 x 40 cm deep shelves

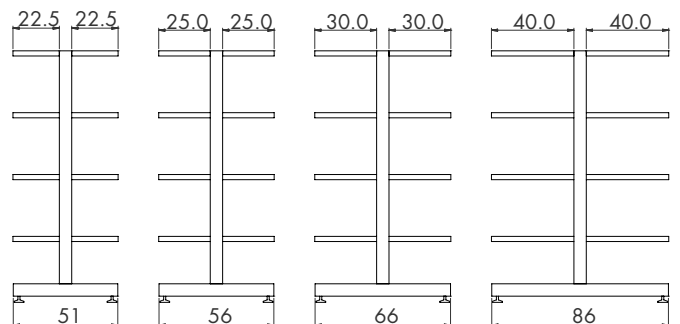
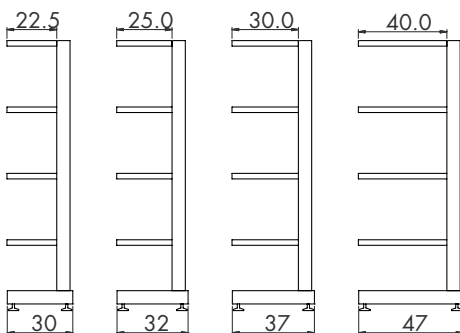



# DIMENSIONS

## 80/30 CLASSIC

Please find important dimensions below, configurations can be found on page 50.

### HEIGHTS

80/30 Classic Steel shelving system comes in 3 heights; 199, 229 and 259 cm. Heights include adjustable feet (max. 2.5 cm). The shelves are adjustable in 2.5 cm increments.

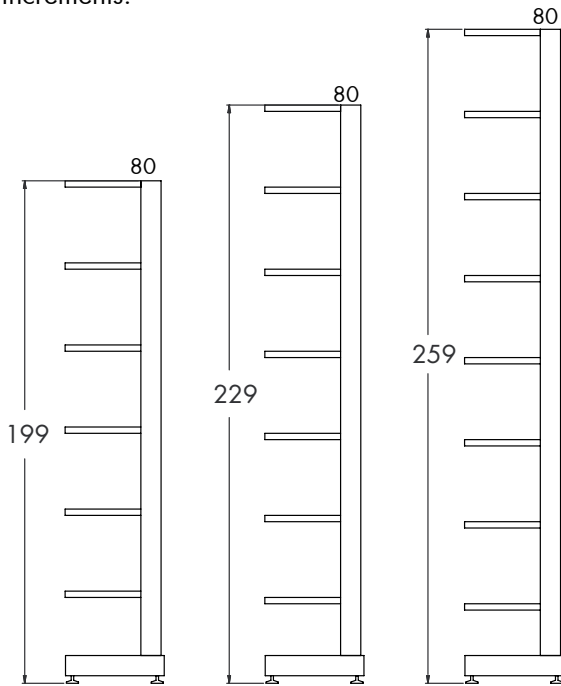

### WIDTHS

The bays are available as starter and add-on bays. A starter bay has two uprights and an add-on bay has one upright.

78 cm is shown as module 75 in price list  
93 cm is shown as module 90 in price list  
103.5 is shown as module 100 in price list\*

Module 75, 90 and 100 indicate distance from centre to centre of uprights.

\*The exact measure of module 100 is 100.5 cm

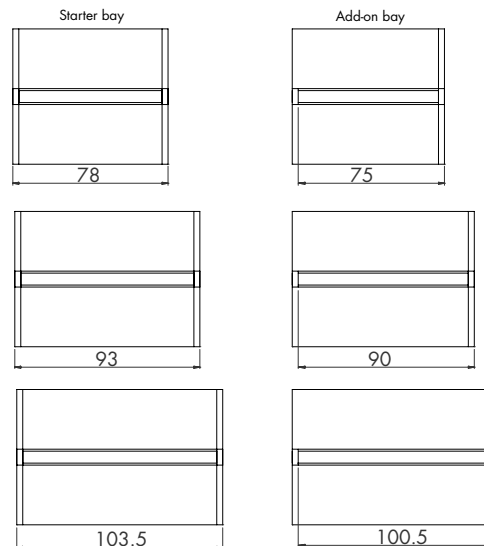

### DEPTHS

The uprights come in 4 depths:  
32 cm for 22.5 cm deep shelves  
34 cm for 25 cm deep shelves  
39 cm for 30 cm deep shelves  
49 cm for 40 cm deep shelves

53 cm for 2x22.5 cm deep shelves  
58 cm for 2x25 cm deep shelves  
68 cm for 2x30 cm deep shelves  
88 cm for 2x40 cm deep shelves

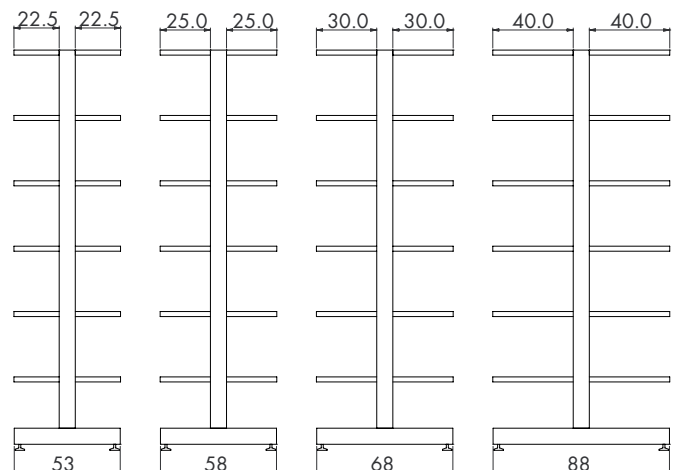
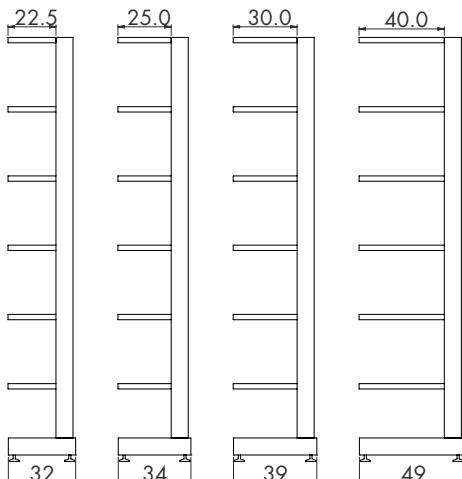

# DIMENSIONS

## 60/30 CLASSIC WALL

Please find important dimensions below, configurations can be found on page 54.

### HEIGHTS

60/30 Classic Steel shelving - Wall system comes in 4 heights; 112.5, 142.5, 172.5 and 202.5 cm. The shelves are adjustable in 2.5 cm increments.

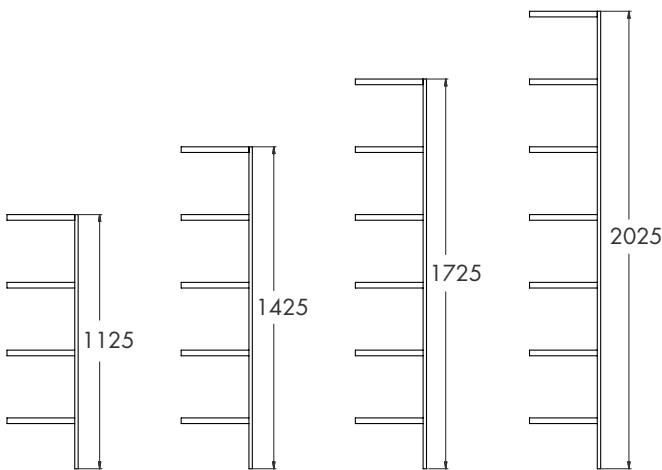

### WIDTHS

The bays are available as starter and add-on bays. A starter bay has two wall strips and an add-on bay has one wall strip.

78 cm is shown as module 75 in price list  
93 cm is shown as module 90 in price list  
103.5 is shown as module 100 in price list\*

Module 75, 90 and 100 indicate distance from centre to centre of uprights.

\*The exact measure of module 100 is 100.5 cm

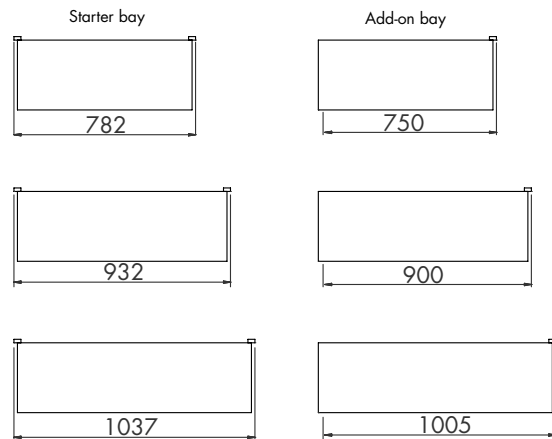

### DEPTHS

The uprights come in 4 depths:  
24 cm for 22.5 cm deep shelves  
26.5 cm for 25 cm deep shelves  
31.5 cm for 30 cm deep shelves  
41.5 cm for 40 cm deep shelves

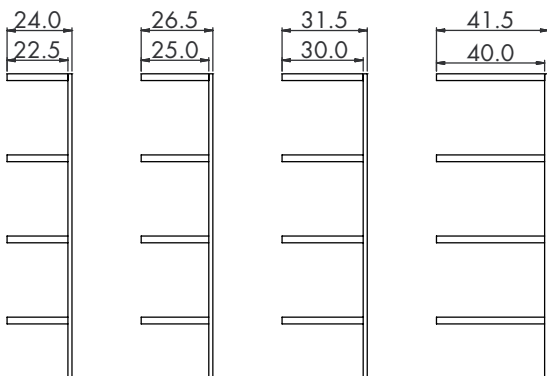

# DIMENSIONS

60/30 EXPO

Please find important dimensions below, configurations can be found on page 58.

## HEIGHTS

60/30 Expo is available in heights 122 cm and 152 cm. Heights include adjustable feet (max. 2.5 cm). The shelves are adjustable in 2.5 cm increments.

## WIDTHS

One bay is 130 cm wide.  
Two bays are 220 cm wide.  
Three bays are 310 cm wide.

## DEPTHS

60/30 Expo is available with a shelf depth of 30 cm.

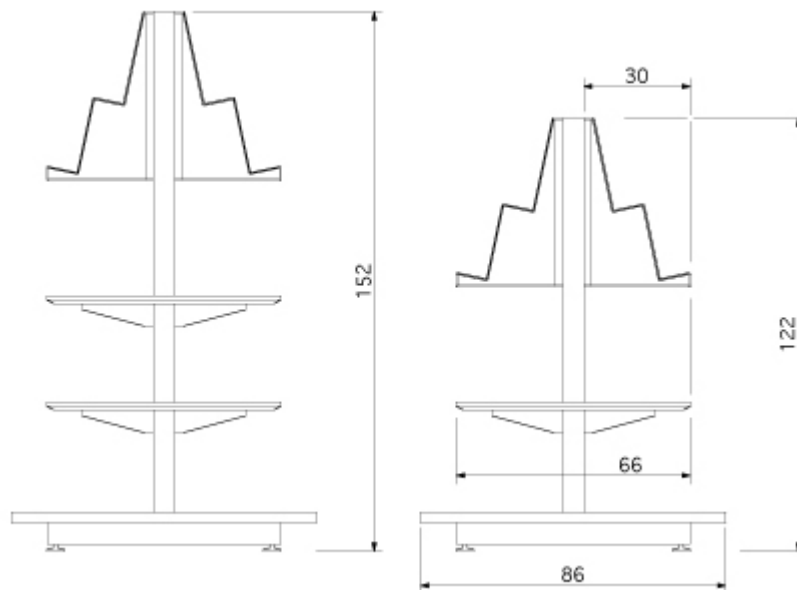

# DIMENSIONS

## 60/30 CLASSIC ROUND

Please find important dimensions below, configurations can be found on page 164.

### HEIGHTS

60/30 Classic Round Steel Shelving system is available in 5 heights; 92, 122, 152, 182 and 212 cm. Heights include adjustable feet (max. 2.5 cm). The shelves are adjustable in 2.5 cm increments.

### WIDTHS

The bays are available as starter and add-on bays. A starter bay has two uprights and an add-on bay has one upright.

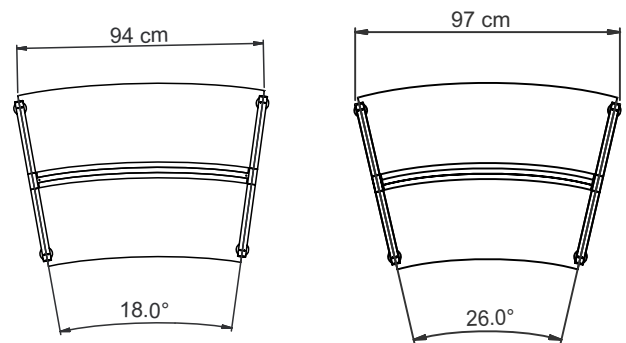
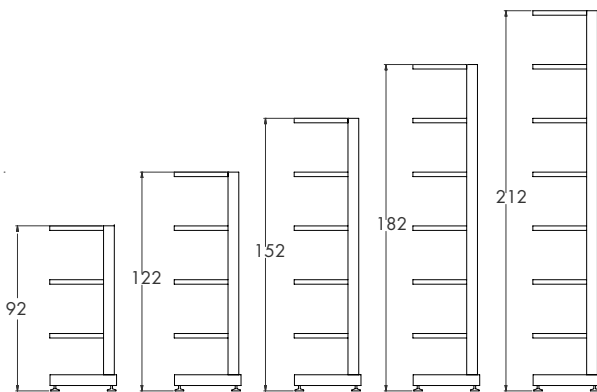

### DEPTHS

The uprights come in one depth:  
66 cm for 2 x 30 cm deep shelves

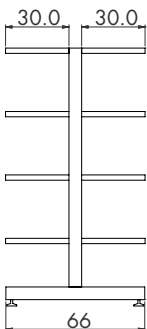

# DIMENSIONS

## 60/30 CLASSIC ROUND

### 60/30 CLASSIC ROUND 26°

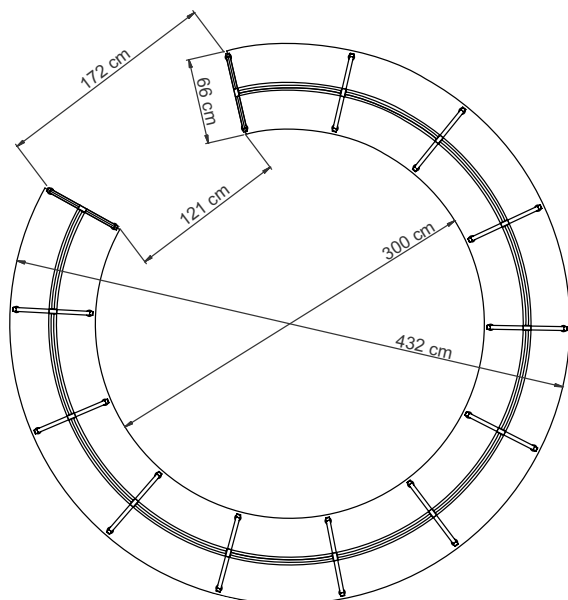

### 60/30 CLASSIC ROUND 18°

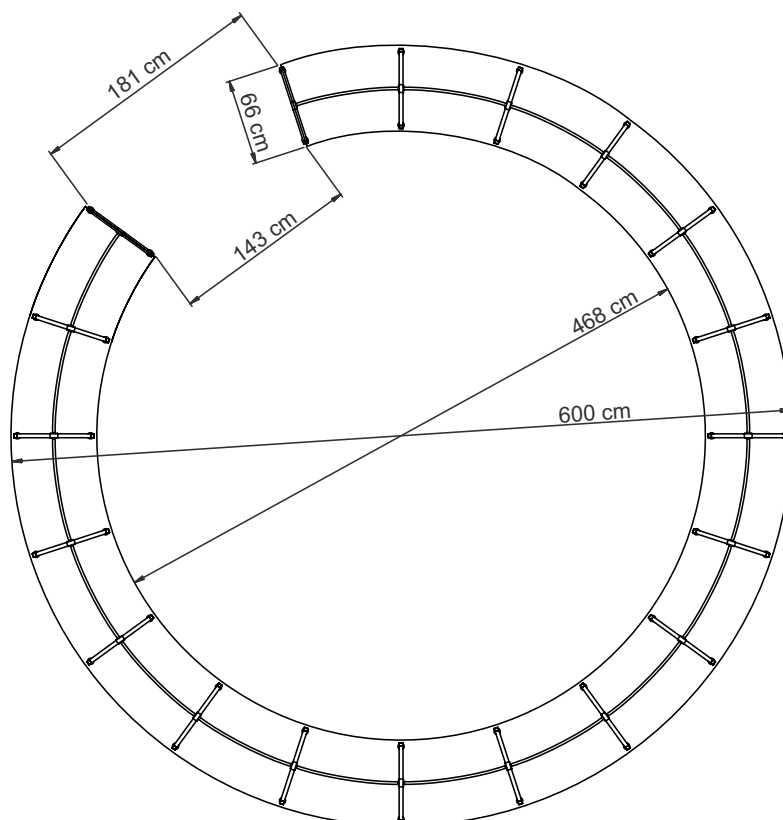

# DIMENSIONS

## 60/30 CLASSIC LONDON TOP PLATE

### LONDON WOODEN AND STEEL OVERLAYING TOP PLATES FOR STRAIGHT BAYS

If you build a shelving system with 1, 2 or 3 bays, then you can use just one freestanding top plate.

If you build a shelving system with more than 3 bays, then the overlaying top plates will be a combination of outer and intermediate overlaying top plates.

#### Freestanding wooden overlaying top plate

Is always used for 1 bay and can be used for 1, 2 or 3 bays. The overlaying top plate covers the end panels in both ends.

Total width mm			
Module	750	900	1000
1 bay	816	966	1071
2 bays	1566	1866	2071
3 bays	2316	2766	3071

#### Freestanding steel overlaying top plate

Is always used for 1 bay and can be used for up to 2 bays for London Steel. The overlaying top plate fits in between both end panels.

Total width mm			
Module	750	900	1000
1 bay	755	905	1010
2 bays	1505	1805	2010
3 bays	-	-	-

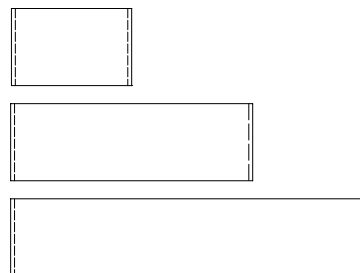

#### Outer wooden overlaying top plate

Can be used for 1, 2 or 3 bays in combination with either outer or intermediate overlaying top plates. The overlaying top plate covers one end panel.

Total width mm			
Module	750	900	1000
1 bay	783	933	1038
2 bays	1533	1833	2038
3 bays	2283	2733	3038

#### Outer steel overlaying top plate

Can be used for 1 and 2 bays in combination with either outer or intermediate overlaying top plates. The overlaying top plate is placed in between the end panel and outer/intermediate top plate.

Total width mm			
Module	750	900	1000
1 bay	753	903	1008
2 bays	1503	1803	2008
3 bays	-	-	-

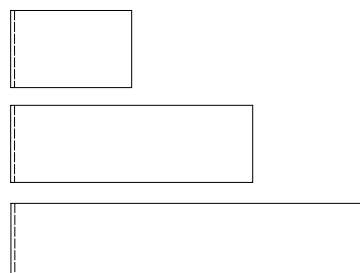

#### Intermediate wooden overlaying top plate

Can be used for 1, 2 or 3 bays in combination with either outer or intermediate overlaying top plates. The overlaying top plate is placed next to the outer/intermediate overlaying top plate.

Total width mm			
Module	750	900	1000
1 bay	751	901	1006
2 bays	1501	1801	2006
3 bays	2251	2701	3006

#### Intermediate steel overlaying top plate

Can be used for 1 and 2 bays in combination with either outer or intermediate overlaying top plates. The overlaying top plate is placed next to the outer/intermediate overlaying top plate.

Total width mm			
Module	750	900	1000
1 bay	750	900	1005
2 bays	1500	1800	2005
3 bays	-	-	-

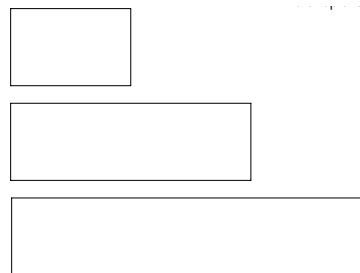

# DIMENSIONS

## 60/30 CLASSIC ROUND LONDON TOP PLATE

### LONDON WOODEN OVERLAYING TOP PLATES FOR ROUND BAYS

Use a freestanding or a combination of outer and intermediate wooden London top plates for your shelving system.

#### Freestanding wooden overlaying top plate

Is always used for 1 bay. The overlaying top plate covers the end panels in both ends.

Dimensions mm				
Bay	26°x	26°y	18°x	18°y
1 bay	1040	724	1006	707

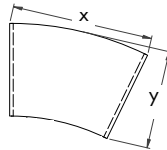

#### Outer wooden overlaying top plate

Can be used in combination with either outer or intermediate top plates. The overlaying top plate covers one end panel.

Dimensions mm				
Bay	26°x	26°y	18°x	18°y
1 bay	1008	724	974	707

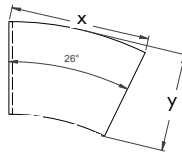

#### Intermediate wooden overlaying top plate

Can be used in combination with either outer or intermediate top plates. The overlaying top plate is placed next to the outer/intermediate overlaying top plate.

Dimensions mm				
Bay	26°x	26°y	18°x	18°y
1 bay	976	716	941	707

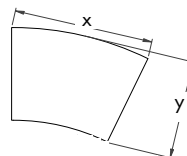

# DIMENSIONS

## END PANEL BAYS FOR DOUBLE-SIDED 60/30 CLASSIC STEEL SHELVING

Please find important dimensions below, configurations can be found on page 150 and 186.

### HEIGHTS

The end panel bays comes in 5 heights for double-sided shelving with/without London wooden top plate. Heights include adjustable feet. The shelves are adjustable in 2.5 cm increments.

For double-sided shelving

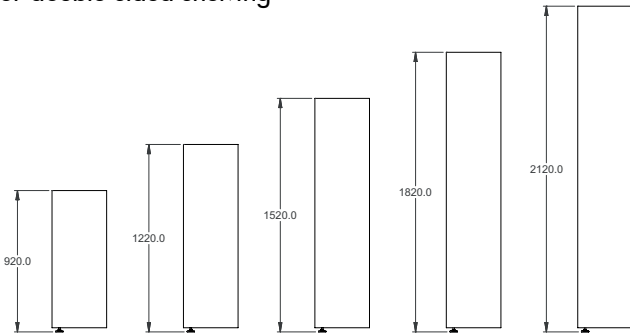

For double-sided shelving with overlaying London wooden top plate

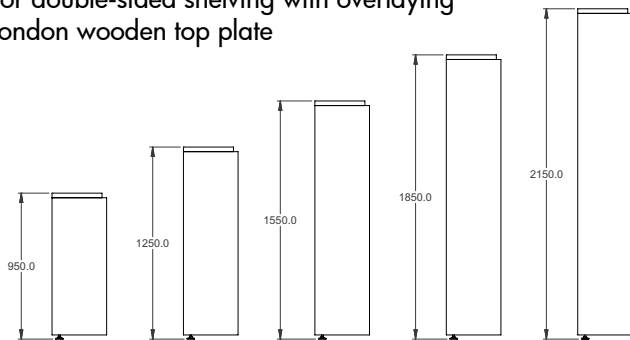

### WIDTHS

The width of the end panel bays depend on the depth of the double-sided shelving system they are mounted on:

52,8 cm - for 22,5/22,5 cm shelving

57,8 cm - for 25/25 cm shelving

67,8 cm - for 30/30 cm shelving

87,8 cm - for 40/40 cm shelving

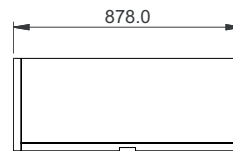
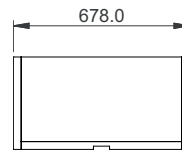
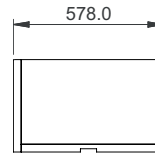
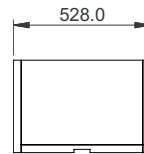

### DEPTHS

The end panel bays come in 2 depths:

30,5 cm - for 25 cm deep shelves

35,5 cm - for 30 cm deep shelves

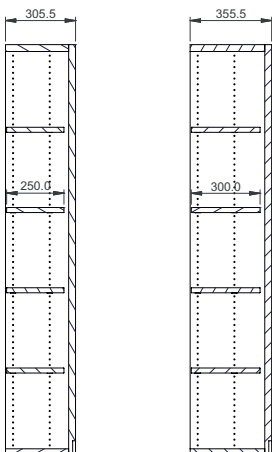





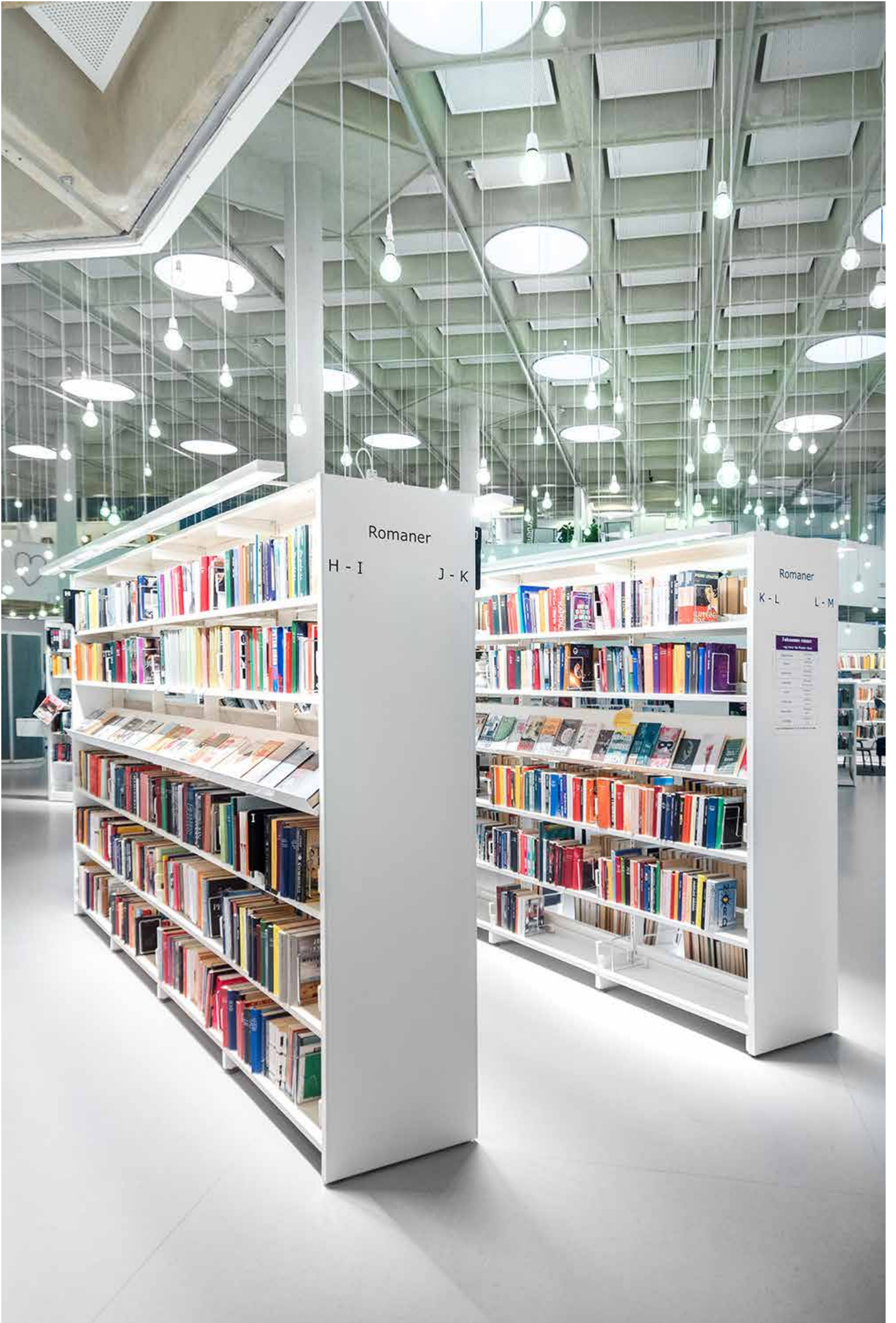

# 60/30 CLASSIC

The following pages will show basic configurations of the 60/30 Classic Steel Shelving system.



# 60/30 CLASSIC

## SINGLE-SIDED - WITHOUT SHELVES

Configurations with uprights, crossbars, fittings and wall securement. Find shelves from page 66.

### Height 92 cm

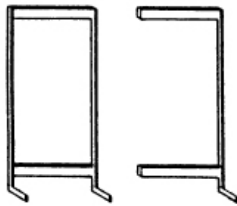

Module cm	Shelf depth cm	Item no. Starter bay	Price DKK	Item no. Add-on bay	Price DKK
75	22.5	BB301007171000	2.850	BB301017171000	1.883
75	25	BB301007271000	2.938	BB301017271000	1.927
75	30	BB301007371000	2.962	BB301017371000	1.939
75	40	BB301007471000	3.020	BB301017471000	1.968
90	22.5	BB301007191000	2.930	BB301017191000	1.963
90	25	BB301007291000	3.018	BB301017291000	2.007
90	30	BB301007391000	3.042	BB301017391000	2.019
90	40	BB301007491000	3.100	BB301017491000	2.048
100	22.5	BB301007111000	3.018	BB301017111000	2.051
100	25	BB301007211000	3.106	BB301017211000	2.095
100	30	BB301007311000	3.130	BB301017311000	2.107
100	40	BB301007411000	3.188	BB301017411000	2.136

### Height 122 cm

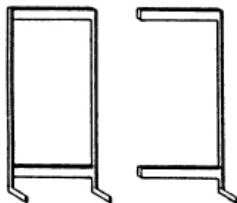

Module cm	Shelf depth cm	Item no. Starter bay	Price DKK	Item no. Add-on bay	Price DKK
75	22.5	BB301002171000	3.066	BB301012171000	1.991
75	25	BB301002271000	3.156	BB301012271000	2.036
75	30	BB301002371000	3.186	BB301012371000	2.051
75	40	BB301002471000	3.248	BB301012471000	2.082
90	22.5	BB301002191000	3.146	BB301012191000	2.071
90	25	BB301002291000	3.236	BB301012291000	2.116
90	30	BB301002391000	3.266	BB301012391000	2.131
90	40	BB301002491000	3.328	BB301012491000	2.162
100	22.5	BB301002111000	3.234	BB301012111000	2.159
100	25	BB301002211000	3.324	BB301012211000	2.204
100	30	BB301002311000	3.354	BB301012311000	2.219
100	40	BB301002411000	3.416	BB301012411000	2.250

### Height 152 cm

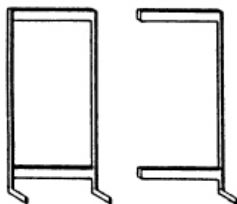

Module cm	Shelf depth cm	Item no. Starter bay	Price DKK	Item no. Add-on bay	Price DKK
75	22.5	BB301005171000	3.296	BB301015171000	2.106
75	25	BB301005271000	3.346	BB301015271000	2.131
75	30	BB301005371000	3.380	BB301015371000	2.148
75	40	BB301005471000	3.428	BB301015471000	2.172
90	22.5	BB301005191000	3.376	BB301015191000	2.186
90	25	BB301005291000	3.426	BB301015291000	2.211
90	30	BB301005391000	3.460	BB301015391000	2.228
90	40	BB301005491000	3.508	BB301015491000	2.252
100	22.5	BB301005111000	3.464	BB301015111000	2.274
100	25	BB301005211000	3.514	BB301015211000	2.299
100	30	BB301005311000	3.548	BB301015311000	2.316
100	40	BB301005411000	3.596	BB301015411000	2.340

# 60/30 CLASSIC

## SINGLE-SIDED - WITHOUT SHELVES

Configurations with uprights, crossbars, fittings and wall securement. Find shelves from page 66.

### Height 182 cm

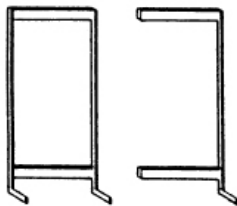

Module cm	Shelf depth cm	Item no. Starter bay	Price DKK	Item no. Add-on bay	Price DKK
75	22.5	BB301008171000	3.508	BB301018171000	2.212
75	25	BB301008271000	3.542	BB301018271000	2.229
75	30	BB301008371000	3.578	BB301018371000	2.247
75	40	BB301008471000	3.652	BB301018471000	2.284
90	22.5	BB301008191000	3.588	BB301018191000	2.292
90	25	BB301008291000	3.622	BB301018291000	2.309
90	30	BB301008391000	3.658	BB301018391000	2.327
90	40	BB301008491000	3.732	BB301018491000	2.364
100	22.5	BB301008111000	3.676	BB301018111000	2.380
100	25	BB301008211000	3.710	BB301018211000	2.397
100	30	BB301008311000	3.746	BB301018311000	2.415
100	40	BB301008411000	3.820	BB301018411000	2.452

### Height 212 cm

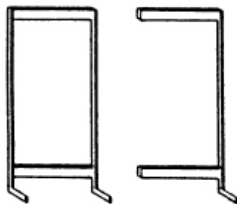

Module cm	Shelf depth cm	Item no. Starter bay	Price DKK	Item no. Add-on bay	Price DKK
75	22.5	BB301001171000	3.728	BB301011171000	2.322
75	25	BB301001271000	3.774	BB301011271000	2.345
75	30	BB301001371000	3.812	BB301011371000	2.364
75	40	BB301001471000	3.868	BB301011471000	2.392
90	22.5	BB301001191000	3.808	BB301011191000	2.402
90	25	BB301001291000	3.854	BB301011291000	2.425
90	30	BB301001391000	3.892	BB301011391000	2.444
90	40	BB301001491000	3.948	BB301011491000	2.472
100	22.5	BB301001111000	3.896	BB301011111000	2.490
100	25	BB301001211000	3.942	BB301011211000	2.513
100	30	BB301001311000	3.980	BB301011311000	2.532
100	40	BB301001411000	4.036	BB301011411000	2.560

# 60/30 CLASSIC

## DOUBLE-SIDED - WITHOUT SHELVES

Configurations with uprights, crossbars and fittings. Find shelves from page 66.

### Height 92 cm

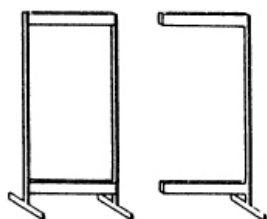

Module cm	Shelf depth cm	Item no. Starter bay	Price DKK	Item no. Add-on bay	Price DKK
75	22.5	BB301007172000	3.026	BB301017172000	1.971
75	25	BB301007272000	3.082	BB301017272000	1.999
75	30	BB301007372000	3.166	BB301017372000	2.041
75	40	BB301007472000	3.256	BB301017472000	2.086
90	22.5	BB301007192000	3.106	BB301017192000	2.051
90	25	BB301007292000	3.162	BB301017292000	2.079
90	30	BB301007392000	3.246	BB301017392000	2.121
90	40	BB301007492000	3.336	BB301017492000	2.166
100	22.5	BB301007112000	3.194	BB301017112000	2.139
100	25	BB301007212000	3.250	BB301017212000	2.167
100	30	BB301007312000	3.334	BB301017312000	2.209
100	40	BB301007412000	3.424	BB301017412000	2.254

### Height 122 cm

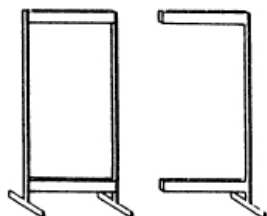

Module cm	Shelf depth cm	Item no. Starter bay	Price DKK	Item no. Add-on bay	Price DKK
75	22.5	BB301002172000	3.264	BB301012172000	2.090
75	25	BB301002272000	3.328	BB301012272000	2.122
75	30	BB301002372000	3.422	BB301012372000	2.169
75	40	BB301002472000	3.508	BB301012472000	2.212
90	22.5	BB301002192000	3.344	BB301012192000	2.170
90	25	BB301002292000	3.408	BB301012292000	2.202
90	30	BB301002392000	3.502	BB301012392000	2.249
90	40	BB301002492000	3.588	BB301012492000	2.292
100	22.5	BB301002112000	3.432	BB301012112000	2.258
100	25	BB301002212000	3.496	BB301012212000	2.290
100	30	BB301002312000	3.590	BB301012312000	2.337
100	40	BB301002412000	3.676	BB301012412000	2.380

### Height 152 cm

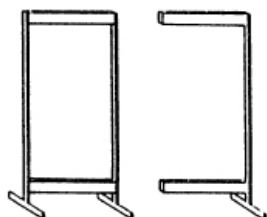

Module cm	Shelf depth cm	Item no. Starter bay	Price DKK	Item no. Add-on bay	Price DKK
75	22.5	BB301005172000	3.540	BB301015172000	2.228
75	25	BB301005272000	3.598	BB301015272000	2.257
75	30	BB301005372000	3.658	BB301015372000	2.287
75	40	BB301005472000	3.806	BB301015472000	2.361
90	22.5	BB301005192000	3.620	BB301015192000	2.308
90	25	BB301005292000	3.678	BB301015292000	2.337
90	30	BB301005392000	3.738	BB301015392000	2.367
90	40	BB301005492000	3.886	BB301015492000	2.441
100	22.5	BB301005112000	3.708	BB301015112000	2.396
100	25	BB301005212000	3.766	BB301015212000	2.425
100	30	BB301005312000	3.826	BB301015312000	2.455
100	40	BB301005412000	3.974	BB301015412000	2.529

# 60/30 CLASSIC

## DOUBLE-SIDED - WITHOUT SHELVES

Configurations with uprights, crossbars and fittings. Find shelves from page 66.

### Height 182 cm

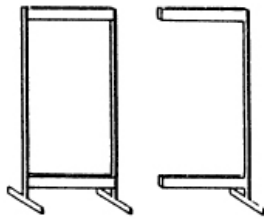

Module cm	Shelf depth cm	Item no. Starter bay	Price DKK	Item no. Add-on bay	Price DKK
75	22.5	BB301008172000	3.658	BB301018172000	2.287
75	25	BB301008272000	3.780	BB301018272000	2.348
75	30	BB301008372000	3.860	BB301018372000	2.388
75	40	BB301008472000	4.002	BB301018472000	2.459
90	22.5	BB301008192000	3.738	BB301018192000	2.367
90	25	BB301008292000	3.860	BB301018292000	2.428
90	30	BB301008392000	3.940	BB301018392000	2.468
90	40	BB301008492000	4.082	BB301018492000	2.539
100	22.5	BB301008112000	3.826	BB301018112000	2.455
100	25	BB301008212000	3.948	BB301018212000	2.516
100	30	BB301008312000	4.028	BB301018312000	2.556
100	40	BB301008412000	4.170	BB301018412000	2.627

### Height 212 cm

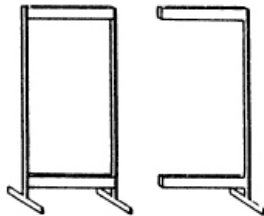

Module cm	Shelf depth cm	Item no. Starter bay	Price DKK	Item no. Add-on bay	Price DKK
75	22.5	BB301001172000	3.974	BB301011172000	2.445
75	25	BB301001272000	4.016	BB301011272000	2.466
75	30	BB301001372000	4.046	BB301011372000	2.481
75	40	BB301001472000	4.186	BB301011472000	2.551
90	22.5	BB301001192000	4.054	BB301011192000	2.525
90	25	BB301001292000	4.096	BB301011292000	2.546
90	30	BB301001392000	4.126	BB301011392000	2.561
90	40	BB301001492000	4.266	BB301011492000	2.631
100	22.5	BB301001112000	4.142	BB301011112000	2.613
100	25	BB301001212000	4.184	BB301011212000	2.634
100	30	BB301001312000	4.214	BB301011312000	2.649
100	40	BB301001412000	4.354	BB301011412000	2.719

# 60/30 CLASSIC

## SINGLE-SIDED - WITH SHELVES - WITHOUT TOP SHELF

Complete shelving system with uprights, crossbars, shelves, brackets, fittings and wall securement. Shelves are steel shelves with backedge. Number of shelves are calculated for optimal shelf spacing for fiction. A starter bay is delivered with one right and one left bracket per shelf. An add-on bay is delivered with a double bracket per shelf, which places the shelves in the same height as that of the starter bay.

### Height 92 cm (2 shelves)

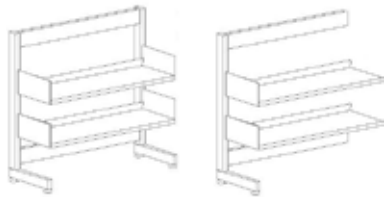

Module cm	Shelf depth cm	Item no. Starter bay	Price DKK	Item no. Add-on bay	Price DKK
75	22.5	BB301007171120	3.984	BB301017171120	2.843
75	25	BB301007271120	4.176	BB301017271120	2.949
75	30	BB301007371120	4.266	BB301017371120	3.029
75	40	BB301007471120	4.594	BB301017471120	3.286
90	22.5	BB301007191120	4.144	BB301017191120	3.003
90	25	BB301007291120	4.304	BB301017291120	3.077
90	30	BB301007391120	4.418	BB301017391120	3.181
90	40	BB301007491120	4.852	BB301017491120	3.544
100	22.5	BB301007111120	4.312	BB301017111120	3.171
100	25	BB301007211120	4.498	BB301017211120	3.271
100	30	BB301007311120	4.598	BB301017311120	3.361
100	40	BB301007411120	4.984	BB301017411120	3.676

### Height 122 cm (3 shelves)

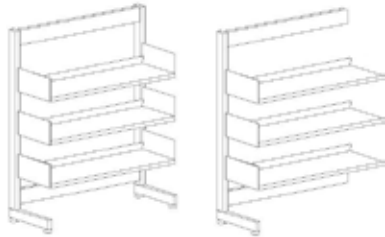

Module cm	Shelf depth cm	Item no. Starter bay	Price DKK	Item no. Add-on bay	Price DKK
75	22.5	BB301002171130	4.767	BB301012171130	3.431
75	25	BB301002271130	5.013	BB301012271130	3.569
75	30	BB301002371130	5.142	BB301012371130	3.686
75	40	BB301002471130	5.609	BB301012471130	4.059
90	22.5	BB301002191130	4.967	BB301012191130	3.631
90	25	BB301002291130	5.165	BB301012291130	3.721
90	30	BB301002391130	5.330	BB301012391130	3.874
90	40	BB301002491130	5.956	BB301012491130	4.406
100	22.5	BB301002111130	5.175	BB301012111130	3.839
100	25	BB301002211130	5.412	BB301012211130	3.968
100	30	BB301002311130	5.556	BB301012311130	4.100
100	40	BB301002411130	6.110	BB301012411130	4.560

### Height 152 cm (4 shelves)

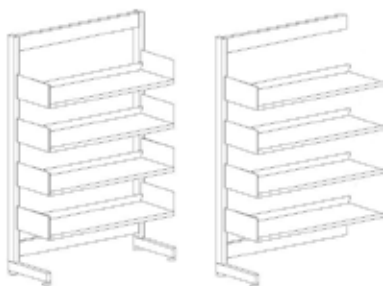

Module cm	Shelf depth cm	Item no. Starter bay	Price DKK	Item no. Add-on bay	Price DKK
75	22.5	BB301005171140	5.564	BB301015171140	4.026
75	25	BB301005271140	5.822	BB301015271140	4.175
75	30	BB301005371140	5.988	BB301015371140	4.328
75	40	BB301005471140	6.576	BB301015471140	4.808
90	22.5	BB301005191140	5.804	BB301015191140	4.266
90	25	BB301005291140	5.998	BB301015291140	4.351
90	30	BB301005391140	6.212	BB301015391140	4.552
90	40	BB301005491140	7.012	BB301015491140	5.244
100	22.5	BB301005111140	6.052	BB301015111140	4.514
100	25	BB301005211140	6.298	BB301015211140	4.651
100	30	BB301005311140	6.484	BB301015311140	4.824
100	40	BB301005411140	7.188	BB301015411140	5.420



# 60/30 CLASSIC

## SINGLE-SIDED - WITH SHELVES - WITHOUT TOP SHELF

Complete shelving system with uprights, crossbars, shelves, brackets, fittings and wall securement. Shelves are steel shelves with backedge. Number of shelves are calculated for optimal shelf spacing for fiction. A starter bay is delivered with one right and one left bracket per shelf. An add-on bay is delivered with a double bracket per shelf, which places the shelves in the same height as that of the starter bay.

### Height 182 cm (5 shelves)

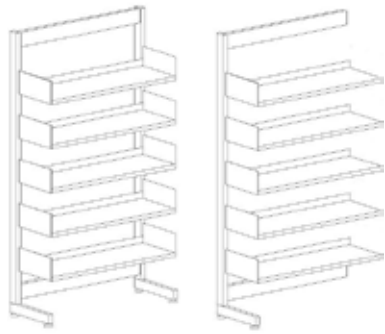

Module cm	Shelf depth cm	Item no. Starter bay	Price DKK	Item no. Add-on bay	Price DKK
75	22.5	BB301008171150	6.343	BB301018171150	4.612
75	25	BB301008271150	6.637	BB301018271150	4.784
75	30	BB301008371150	6.838	BB301018371150	4.972
75	40	BB301008471150	7.587	BB301018471150	5.579
90	22.5	BB301008191150	6.623	BB301018191150	4.892
90	25	BB301008291150	6.837	BB301018291150	4.984
90	30	BB301008391150	7.098	BB301018391150	5.232
90	40	BB301008491150	8.112	BB301018491150	6.104
100	22.5	BB301008111150	6.911	BB301018111150	5.180
100	25	BB301008211150	7.190	BB301018211150	5.337
100	30	BB301008311150	7.416	BB301018311150	5.550
100	40	BB301008411150	8.310	BB301018411150	6.302

### Height 212 cm (6 shelves)

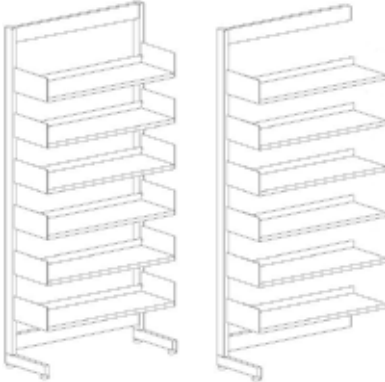

Module cm	Shelf depth cm	Item no. Starter bay	Price DKK	Item no. Add-on bay	Price DKK
75	22.5	BB301001171160	7.130	BB301011171160	5.202
75	25	BB301001271160	7.488	BB301011271160	5.411
75	30	BB301001371160	7.724	BB301011371160	5.634
75	40	BB301001471160	8.590	BB301011471160	6.346
90	22.5	BB301001191160	7.450	BB301011191160	5.522
90	25	BB301001291160	7.712	BB301011291160	5.635
90	30	BB301001391160	8.020	BB301011391160	5.930
90	40	BB301001491160	9.204	BB301011491160	6.960
100	22.5	BB301001111160	7.778	BB301011111160	5.850
100	25	BB301001211160	8.118	BB301011211160	6.041
100	30	BB301001311160	8.384	BB301011311160	6.294
100	40	BB301001411160	9.424	BB301011411160	7.180

# 60/30 CLASSIC

## DOUBLE-SIDED - WITH SHELVES - WITHOUT TOP SHELF

Complete shelving system with uprights, crossbars, shelves, brackets and fittings. Shelves are steel shelves with backedge. Number of shelves are calculated for optimal shelf spacing for fiction. A starter bay is delivered with one right and one left bracket per shelf. An add-on bay is delivered with a double bracket per shelf, which places the shelves in the same height as that of the starter bay.

### Height 92 cm (2 shelves on each side)

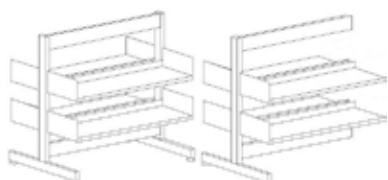

Module cm	Shelf depth cm	Item no. Starter bay	Price DKK	Item no. Add-on bay	Price DKK
75	22.5	BB301007172120	5.294	BB301017172120	3.891
75	25	BB301007272120	5.558	BB301017272120	4.043
75	30	BB301007372120	5.774	BB301017372120	4.221
75	40	BB301007472120	6.404	BB301017472120	4.722
90	22.5	BB301007192120	5.534	BB301017192120	4.131
90	25	BB301007292120	5.734	BB301017292120	4.219
90	30	BB301007392120	5.998	BB301017392120	4.445
90	40	BB301007492120	6.840	BB301017492120	5.158
100	22.5	BB301007112120	5.782	BB301017112120	4.379
100	25	BB301007212120	6.034	BB301017212120	4.519
100	30	BB301007312120	6.270	BB301017312120	4.717
100	40	BB301007412120	7.016	BB301017412120	5.334

### Height 122 cm (3 shelves on each side)

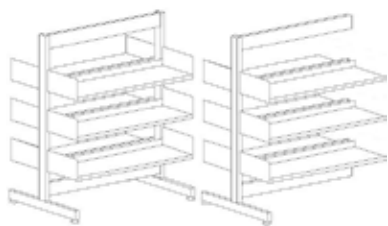

Module cm	Shelf depth cm	Item no. Starter bay	Price DKK	Item no. Add-on bay	Price DKK
75	22.5	BB301002172130	6.666	BB301012172130	4.970
75	25	BB301002272130	7.042	BB301012272130	5.188
75	30	BB301002372130	7.334	BB301012372130	5.439
75	40	BB301002472130	8.230	BB301012472130	6.166
90	22.5	BB301002192130	6.986	BB301012192130	5.290
90	25	BB301002292130	7.266	BB301012292130	5.412
90	30	BB301002392130	7.630	BB301012392130	5.735
90	40	BB301002492130	8.844	BB301012492130	6.780
100	22.5	BB301002112130	7.314	BB301012112130	5.618
100	25	BB301002212130	7.672	BB301012212130	5.818
100	30	BB301002312130	7.994	BB301012312130	6.099
100	40	BB301002412130	9.064	BB301012412130	7.000

### Height 152 cm (4 shelves on each side)

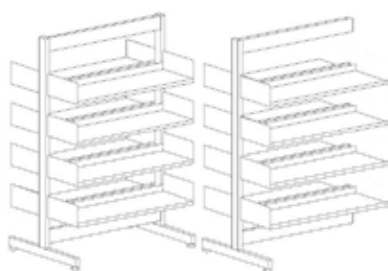

Module cm	Shelf depth cm	Item no. Starter bay	Price DKK	Item no. Add-on bay	Price DKK
75	22.5	BB301005172140	8.076	BB301015172140	6.068
75	25	BB301005272140	8.550	BB301015272140	6.345
75	30	BB301005372140	8.874	BB301015372140	6.647
75	40	BB301005472140	10.102	BB301015472140	7.633
90	22.5	BB301005192140	8.476	BB301015192140	6.468
90	25	BB301005292140	8.822	BB301015292140	6.617
90	30	BB301005392140	9.242	BB301015392140	7.015
90	40	BB301005492140	10.894	BB301015492140	8.425
100	22.5	BB301005112140	8.884	BB301015112140	6.876
100	25	BB301005212140	9.334	BB301015212140	7.129
100	30	BB301005312140	9.698	BB301015312140	7.471
100	40	BB301005412140	11.158	BB301015412140	8.689

# 60/30 CLASSIC

## DOUBLE-SIDED - WITH SHELVES - WITHOUT TOP SHELF

Complete shelving system with uprights, crossbars, shelves, brackets and fittings. Shelves are steel shelves with backedge. Number of shelves are calculated for optimal shelf spacing for fiction. A starter bay is delivered with one right and one left bracket per shelf. An add-on bay is delivered with a double bracket per shelf, which places the shelves in the same height as that of the starter bay.

### Height 182 cm (5 shelves on each side)

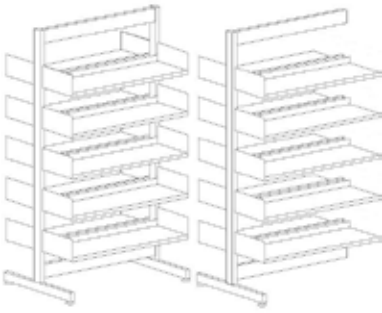
	Module cm	Shelf depth cm	Item no.	Price	Item no.	Price
			Starter bay	DKK	Add-on bay	DKK
	75	22.5	BB301008172150	9.328	BB301018172150	7.087
	75	25	BB301008272150	9.970	BB301018272150	7.458
	75	30	BB301008372150	10.380	BB301018372150	7.838
	75	40	BB301008472150	11.872	BB301018472150	9.049
	90	22.5	BB301008192150	9.808	BB301018192150	7.567
	90	25	BB301008292150	10.290	BB301018292150	7.778
	90	30	BB301008392150	10.820	BB301018392150	8.278
	90	40	BB301008492150	12.842	BB301018492150	10.019
	100	22.5	BB301008112150	10.296	BB301018112150	8.055
	100	25	BB301008212150	10.908	BB301018212150	8.396
	100	30	BB301008312150	11.368	BB301018312150	8.826
	100	40	BB301008412150	13.150	BB301018412150	10.327

### Height 212 cm (6 shelves on each side)

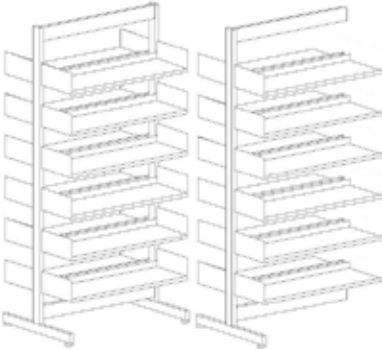
	Module cm	Shelf depth cm	Item no.	Price	Item no.	Price
			Starter bay	DKK	Add-on bay	DKK
	75	22.5	BB301001172160	10.778	BB301011172160	8.205
	75	25	BB301001272160	11.444	BB301011272160	8.598
	75	30	BB301001372160	11.870	BB301011372160	9.021
	75	40	BB301001472160	13.630	BB301011472160	10.459
	90	22.5	BB301001192160	11.338	BB301011192160	8.765
	90	25	BB301001292160	11.812	BB301011292160	8.966
	90	30	BB301001392160	12.382	BB301011392160	9.533
	90	40	BB301001492160	14.778	BB301011492160	11.607
	100	22.5	BB301001112160	11.906	BB301011112160	9.333
	100	25	BB301001212160	12.536	BB301011212160	9.690
	100	30	BB301001312160	13.022	BB301011312160	10.173
	100	40	BB301001412160	15.130	BB301011412160	11.959

# 60/30 CLASSIC

## SINGLE-SIDED - WITH SHELVES AND TOP SHELF

Complete shelving system with uprights, crossbars, shelves, top shelf, brackets, fittings and wall securement. Shelves are steel shelves with backedge, top shelf is steel shelf without backedge. Number of shelves are calculated for optimal shelf spacing for fiction. A starter bay is delivered with one right and one left bracket per shelf. An add-on bay is delivered with a double bracket per shelf, which places the shelves in the same height as that of the starter bay.

### Height 92 cm (2 shelves + top shelf)

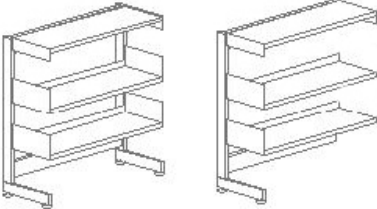
	Module cm	Shelf depth cm	Item no.	Price	Item no.	Price
			Starter bay	DKK	Add-on bay	DKK
	75	22.5	BB301007171121	4.607	BB301017171121	3.359
	75	25	BB301007271121	4.809	BB301017271121	3.475
	75	30	BB301007371121	4.964	BB301017371121	3.620
	75	40	BB301007471121	5.386	BB301017471121	3.961
	90	22.5	BB301007191121	4.781	BB301017191121	3.533
	90	25	BB301007291121	4.984	BB301017291121	3.650
	90	30	BB301007391121	5.139	BB301017391121	3.795
	90	40	BB301007491121	5.718	BB301017491121	4.293
	100	22.5	BB301007111121	5.015	BB301017111121	3.767
	100	25	BB301007211121	5.233	BB301017211121	3.899
	100	30	BB301007311121	5.365	BB301017311121	4.021
	100	40	BB301007411121	5.883	BB301017411121	4.458

### Height 122 cm (3 shelves + top shelf)

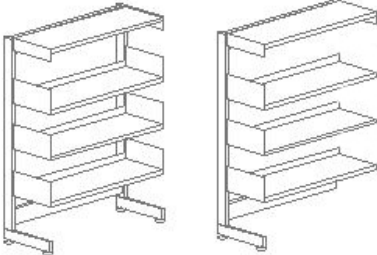
	Module cm	Shelf depth cm	Item no.	Price	Item no.	Price
			Starter bay	DKK	Add-on bay	DKK
	75	22.5	BB301002171131	5.390	BB301012171131	3.947
	75	25	BB301002271131	5.646	BB301012271131	4.095
	75	30	BB301002371131	5.840	BB301012371131	4.277
	75	40	BB301002471131	6.401	BB301012471131	4.734
	90	22.5	BB301002191131	5.604	BB301012191131	4.161
	90	25	BB301002291131	5.845	BB301012291131	4.294
	90	30	BB301002391131	6.051	BB301012391131	4.488
	90	40	BB301002491131	6.822	BB301012491131	5.155
	100	22.5	BB301002111131	5.878	BB301012111131	4.435
	100	25	BB301002211131	6.147	BB301012211131	4.596
	100	30	BB301002311131	6.323	BB301012311131	4.760
	100	40	BB301002411131	7.009	BB301012411131	5.342

### Height 152 cm (4 shelves + top shelf)

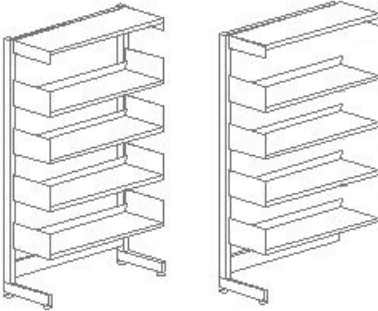
	Module cm	Shelf depth cm	Item no.	Price	Item no.	Price
			Starter bay	DKK	Add-on bay	DKK
	75	22.5	BB301005171141	6.187	BB301015171141	4.542
	75	25	BB301005271141	6.455	BB301015271141	4.701
	75	30	BB301005371141	6.686	BB301015371141	4.919
	75	40	BB301005471141	7.368	BB301015471141	5.483
	90	22.5	BB301005191141	6.441	BB301015191141	4.796
	90	25	BB301005291141	6.678	BB301015291141	4.924
	90	30	BB301005391141	6.933	BB301015391141	5.166
	90	40	BB301005491141	7.878	BB301015491141	5.993
	100	22.5	BB301005111141	6.755	BB301015111141	5.110
	100	25	BB301005211141	7.033	BB301015211141	5.279
	100	30	BB301005311141	7.251	BB301015311141	5.484
	100	40	BB301005411141	8.087	BB301015411141	6.202

# 60/30 CLASSIC

## SINGLE-SIDED - WITH SHELVES AND TOP SHELF

Complete shelving system with uprights, crossbars, shelves, top shelf, brackets, fittings and wall securement. Shelves are steel shelves with backedge, top shelf is steel shelf without backedge. Number of shelves are calculated for optimal shelf spacing for fiction. A starter bay is delivered with one right and one left bracket per shelf. An add-on bay is delivered with a double bracket per shelf, which places the shelves in the same height as that of the starter bay.

### Height 182 cm (5 shelves + top shelf)

	Module cm	Shelf depth cm	Item no.	Price	Item no.	Price
			Starter bay	DKK	Add-on bay	DKK
	75	22.5	BB301008171151	6.966	BB301018171151	5.128
	75	25	BB301008271151	7.270	BB301018271151	5.310
	75	30	BB301008371151	7.536	BB301018371151	5.563
	75	40	BB301008371151	7.536	BB301018471151	6.254
	90	22.5	BB301008191151	7.260	BB301018191151	5.422
	90	25	BB301008291151	7.517	BB301018291151	5.557
	90	30	BB301008391151	7.819	BB301018391151	5.846
	90	40	BB301008491151	8.978	BB301018491151	6.853
	100	22.5	BB301008111151	7.614	BB301018111151	5.776
	100	25	BB301008211151	7.925	BB301018211151	5.965
	100	30	BB301008311151	8.183	BB301018311151	6.210
	100	40	BB301008411151	9.209	BB301018411151	7.084

### Height 212 cm (6 shelves + top shelf)

	Module cm	Shelf depth cm	Item no.	Price	Item no.	Price
			Starter bay	DKK	Add-on bay	DKK
	75	22.5	BB301001171161	7.753	BB301011171161	5.718
	75	25	BB301001271161	8.121	BB301011271161	5.937
	75	30	BB301001371161	8.422	BB301011371161	6.225
	75	40	BB301001471161	9.382	BB301011471161	7.021
	90	22.5	BB301001191161	8.087	BB301011191161	6.052
	90	25	BB301001291161	8.392	BB301011291161	6.208
	90	30	BB301001391161	8.741	BB301011391161	6.544
	90	40	BB301001491161	10.070	BB301011491161	7.709
	100	22.5	BB301001111161	8.481	BB301011111161	6.446
	100	25	BB301001211161	8.853	BB301011211161	6.669
	100	30	BB301001311161	9.151	BB301011311161	6.954
	100	40	BB301001411161	10.323	BB301011411161	7.962

# 60/30 CLASSIC

## DOUBLE-SIDED - WITH SHELVES AND TOP SHELVES

Complete shelving system with uprights, crossbars, shelves, top shelf, brackets and fittings. Shelves are steel shelves with backedge, top shelf is steel shelf without backedge. Number of shelves are calculated for optimal shelf spacing for fiction. A starter bay is delivered with one right and one left bracket per shelf. An add-on bay is delivered with a double bracket per shelf, which places the shelves in the same height as that of the starter bay.

### Height 92 cm (2 shelves + top shelf on each side)

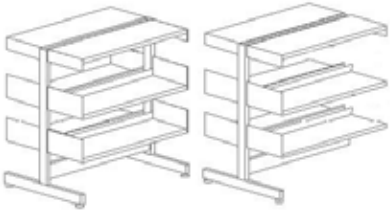
	Module cm	Shelf depth cm	Item no. Starter bay	Price DKK	Item no. Add-on bay	Price DKK
	75	22.5	BB301007172121	6.540	BB301017172121	4.923
	75	25	BB301007272121	6.824	BB301017272121	5.095
	75	30	BB301007372121	7.170	BB301017372121	5.403
	75	40	BB301007472121	7.988	BB301017472121	6.072
	90	22.5	BB301007192121	6.808	BB301017192121	5.191
	90	25	BB301007292121	7.094	BB301017292121	5.365
	90	30	BB301007392121	7.440	BB301017392121	5.673
	90	40	BB301007492121	8.572	BB301017492121	6.656
	100	22.5	BB301007112121	7.188	BB301017112121	5.571
	100	25	BB301007212121	7.504	BB301017212121	5.775
	100	30	BB301007312121	7.804	BB301017312121	6.037
	100	40	BB301007412121	8.814	BB301017412121	6.898

### Height 122 cm (3 shelves + top shelf on each side)

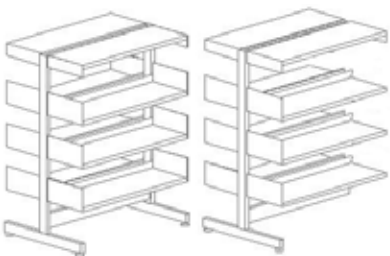
	Module cm	Shelf depth cm	Item no. Starter bay	Price DKK	Item no. Add-on bay	Price DKK
	75	22.5	BB301002172131	7.912	BB301012172131	6.002
	75	25	BB301002272131	8.308	BB301012272131	6.240
	75	30	BB301002372131	8.730	BB301012372131	6.621
	75	40	BB301002472131	9.814	BB301012472131	7.516
	90	22.5	BB301002192131	8.260	BB301012192131	6.350
	90	25	BB301002292131	8.626	BB301012292131	6.558
	90	30	BB301002392131	9.072	BB301012392131	6.963
	90	40	BB301002492131	10.576	BB301012492131	8.278
	100	22.5	BB301002112131	8.720	BB301012112131	6.810
	100	25	BB301002212131	9.142	BB301012212131	7.074
	100	30	BB301002312131	9.528	BB301012312131	7.419
	100	40	BB301002412131	10.862	BB301012412131	8.564

### Height 152 cm (4 shelves + top shelf on each side)

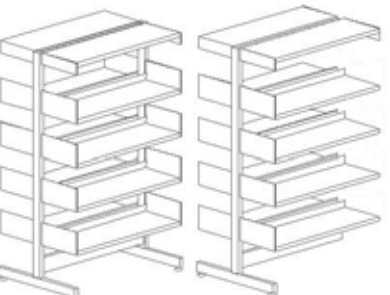
	Module cm	Shelf depth cm	Item no. Starter bay	Price DKK	Item no. Add-on bay	Price DKK
	75	22.5	BB301005172141	9.322	BB301015172141	7.100
	75	25	BB301005272141	9.816	BB301015272141	7.397
	75	30	BB301005372141	10.270	BB301015372141	7.829
	75	40	BB301005472141	11.686	BB301015472141	8.983
	90	22.5	BB301005192141	9.750	BB301015192141	7.528
	90	25	BB301005292141	10.182	BB301015292141	7.763
	90	30	BB301005392141	10.684	BB301015392141	8.243
	90	40	BB301005492141	12.626	BB301015492141	9.923
	100	22.5	BB301005112141	10.290	BB301015112141	8.068
	100	25	BB301005212141	10.804	BB301015212141	8.385
	100	30	BB301005312141	11.232	BB301015312141	8.791
	100	40	BB301005412141	12.956	BB301015412141	10.253

# 60/30 CLASSIC

## DOUBLE-SIDED - WITH SHELVES AND TOP SHELVES

Complete shelving system with uprights, crossbars, shelves, top shelf, brackets and fittings. Shelves are steel shelves with backedge, top shelf is steel shelf without backedge. Number of shelves are calculated for optimal shelf spacing for fiction. A starter bay is delivered with one right and one left bracket per shelf. An add-on bay is delivered with a double bracket per shelf, which places the shelves in the same height as that of the starter bay.

### Height 182 cm (5 shelves + top shelf on each side)

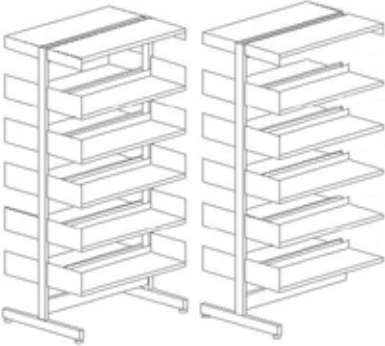
	Module cm	Shelf depth cm	Item no. Starter bay	Price DKK	Item no. Add-on bay	Price DKK
	75	22.5	BB301008172151	10.574	BB301018172151	8.119
	75	25	BB301008272151	11.236	BB301018272151	8.510
	75	30	BB301008372151	11.776	BB301018372151	9.020
	75	40	BB301008472151	13.456	BB301018472151	10.399
	90	22.5	BB301008192151	11.082	BB301018192151	8.627
	90	25	BB301008292151	11.650	BB301018292151	8.924
	90	30	BB301008392151	12.262	BB301018392151	9.506
	90	40	BB301008492151	14.574	BB301018492151	11.517
	100	22.5	BB301008112151	11.702	BB301018112151	9.247
	100	25	BB301008212151	12.378	BB301018212151	9.652
	100	30	BB301008312151	12.902	BB301018312151	10.146
	100	40	BB301008412151	14.948	BB301018412151	11.891

### Height 212 cm (6 shelves + top shelf on each side)

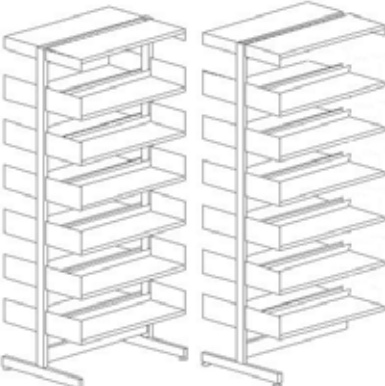
	Module cm	Shelf depth cm	Item no. Starter bay	Price DKK	Item no. Add-on bay	Price DKK
	75	22.5	BB301001172161	12.024	BB301011172161	9.237
	75	25	BB301001272161	12.710	BB301011272161	9.650
	75	30	BB301001372161	13.266	BB301011372161	10.203
	75	40	BB301001472161	15.214	BB301011472161	11.809
	90	22.5	BB301001192161	12.612	BB301011192161	9.825
	90	25	BB301001292161	13.172	BB301011292161	10.112
	90	30	BB301001392161	13.824	BB301011392161	10.761
	90	40	BB301001492161	16.510	BB301011492161	13.105
	100	22.5	BB301001112161	13.312	BB301011112161	10.525
	100	25	BB301001212161	14.006	BB301011212161	10.946
	100	30	BB301001312161	14.556	BB301011312161	11.493
	100	40	BB301001412161	16.928	BB301011412161	13.523

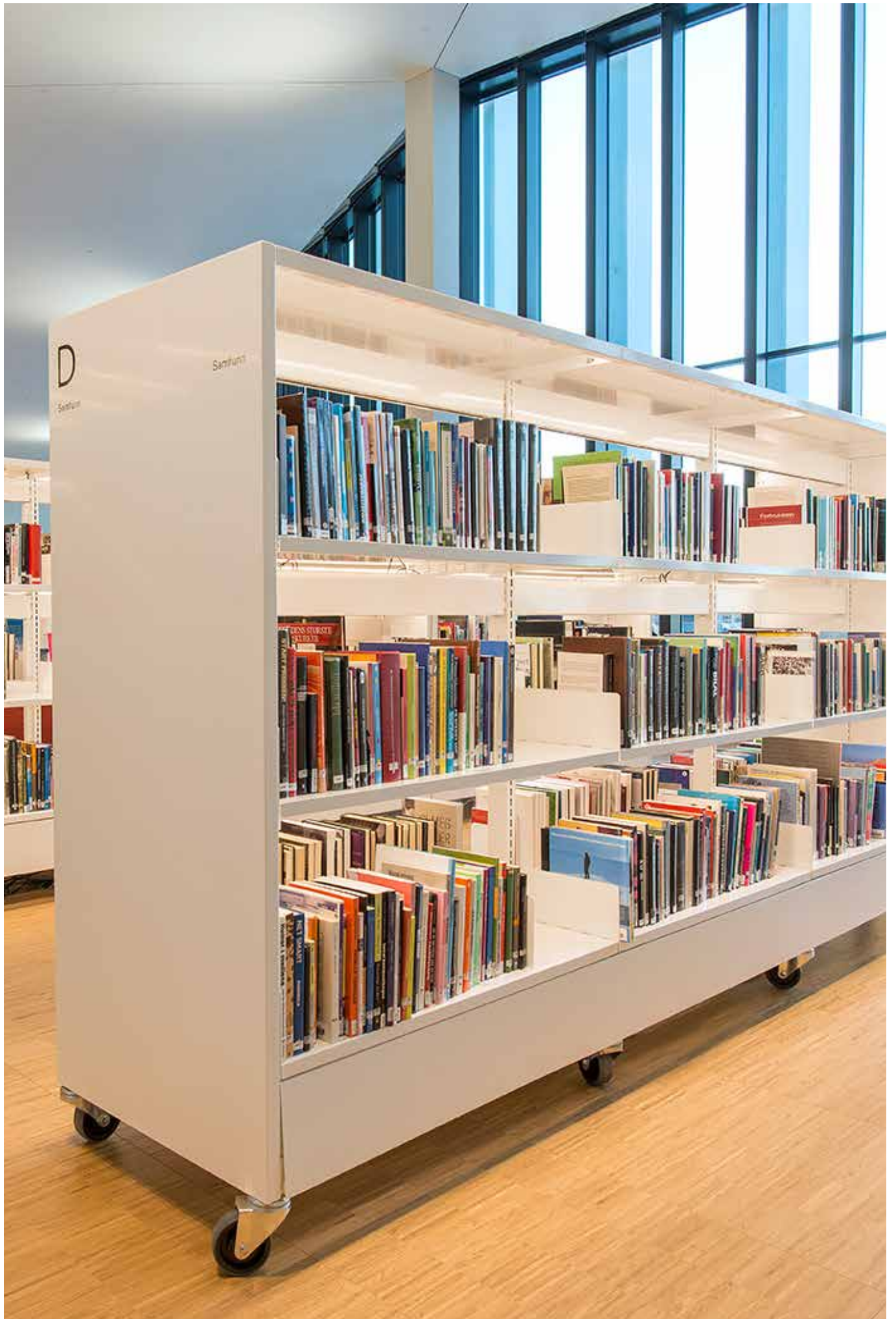



# 60/30 CLASSIC WITH LED

The following pages will show basic configurations of the 60/30 Classic Steel Shelving system with LED based on 60/30 upright installations.



# 60/30 CLASSIC WITH LED

## SINGLE-SIDED - WITHOUT TOP SHELF AND WITH LED LIGHTING ON INTERMEDIATE SHELVES

Complete shelving system with uprights, cable channels, crossbars, steel shelves with backedge and LED lighting (see page 160 for details on LED lighting), brackets, fittings and wall securement. Cabling from bottom (cabling from above is an option, contact sales). Number of shelves are calculated for optimal shelf spacing for fiction. The LED light is placed underneath each shelf and the cable channel is placed on the left side of the bay. A starter bay is delivered with one right and one left bracket per shelf. An add-on bay is delivered with a double bracket per shelf, which places the shelves in the same height as that of the starter bay.

### Height 92 cm (2 shelves and 1 LED light)

Please contact Sales for prices on 60/30 configurations with LED.

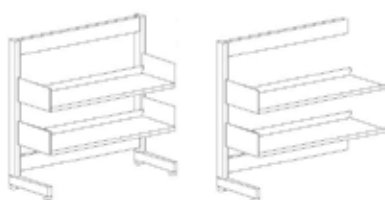

Module cm	Shelf depth cm	Item no. Starter bay	Price DKK	Item no. Add-on bay	Price DKK
75	22.5	BB30203717141120	-	BB30204717141120	-
75	25	BB30203727141120	-	BB30204727141120	-
75	30	BB30203737141120	-	BB30204737141120	-
75	40	BB30203747141120	-	BB30204747141120	-
90	22.5	BB30203719141120	-	BB30204719141120	-
90	25	BB30203729141120	-	BB30204729141120	-
90	30	BB30203739141120	-	BB30204739141120	-
90	40	BB30203749141120	-	BB30204749141120	-
100	22.5	BB30203711141120	-	BB30204711141120	-
100	25	BB30203721141120	-	BB30204721141120	-
100	30	BB30203731141120	-	BB30204731141120	-
100	40	BB30203741141120	-	BB30204741141120	-

### Height 122 cm (3 shelves and 2 LED lights)

Please contact Sales for prices on 60/30 configurations with LED.

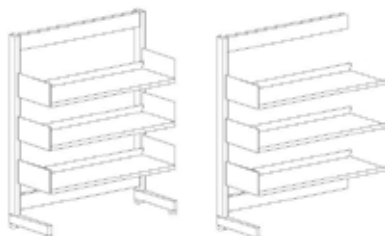

Module cm	Shelf depth cm	Item no. Starter bay	Price DKK	Item no. Add-on bay	Price DKK
75	22.5	BB30203217141130	-	BB30204217141130	-
75	25	BB30203227141130	-	BB30204227141130	-
75	30	BB30203237141130	-	BB30204237141130	-
75	40	BB30203247141130	-	BB30204247141130	-
90	22.5	BB30203219141130	-	BB30204219141130	-
90	25	BB30203229141130	-	BB30204229141130	-
90	30	BB30203239141130	-	BB30204239141130	-
90	40	BB30203249141130	-	BB30204249141130	-
100	22.5	BB30203211141130	-	BB30204211141130	-
100	25	BB30203221141130	-	BB30204221141130	-
100	30	BB30203231141130	-	BB30204231141130	-
100	40	BB30203241141130	-	BB30204241141130	-

### Height 152 cm (4 shelves and and 3 LED lights)

Please contact Sales for prices on 60/30 configurations with LED.

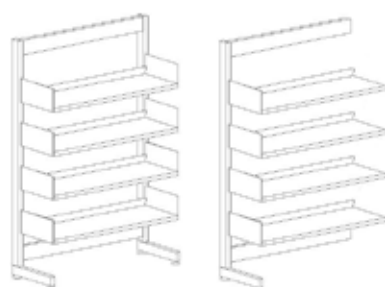

Module cm	Shelf depth cm	Item no. Starter bay	Price DKK	Item no. Add-on bay	Price DKK
75	22.5	BB30203517141140	-	BB30204517141140	-
75	25	BB30203527141140	-	BB30204527141140	-
75	30	BB30203537141140	-	BB30204537141140	-
75	40	BB30203547141140	-	BB30204547141140	-
90	22.5	BB30203519141140	-	BB30204519141140	-
90	25	BB30203529141140	-	BB30204529141140	-
90	30	BB30203539141140	-	BB30204539141140	-
90	40	BB30203549141140	-	BB30204549141140	-
100	22.5	BB30203511141140	-	BB30204511141140	-
100	25	BB30203521141140	-	BB30204521141140	-
100	30	BB30203531141140	-	BB30204531141140	-
100	40	BB30203541141140	-	BB30204541141140	-

# 60/30 CLASSIC WITH LED

## SINGLE-SIDED - WITHOUT TOP SHELF AND WITH LED LIGHTING ON INTERMEDIATE SHELVES

Complete shelving system with uprights, cable channels, crossbars, steel shelves with backedge and LED lighting (see page 160 for details on LED lighting), brackets, fittings and wall securement. Cabling from bottom (cabling from above is an option, contact sales). Number of shelves are calculated for optimal shelf spacing for fiction. The LED light is placed underneath each shelf and the cable channel is placed on the left side of the bay. A starter bay is delivered with one right and one left bracket per shelf. An add-on bay is delivered with a double bracket per shelf, which places the shelves in the same height as that of the starter bay.

### Height 182 cm (5 shelves and 4 LED lights)

Please contact Sales for prices on 60/30 configurations with LED.

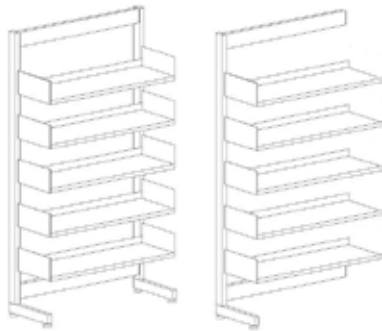

Module cm	Shelf depth cm	Item no. Starter bay	Price DKK	Item no. Add-on bay	Price DKK
75	22.5	BB30203817141150	-	BB30204817141150	-
75	25	BB30203827141150	-	BB30204827141150	-
75	30	BB30203837141150	-	BB30204837141150	-
75	40	BB30203847141150	-	BB30204847141150	-
90	22.5	BB30203819141150	-	BB30204819141150	-
90	25	BB30203829141150	-	BB30204829141150	-
90	30	BB30203839141150	-	BB30204839141150	-
90	40	BB30203849141150	-	BB30204849141150	-
100	22.5	BB30203811141150	-	BB30204811141150	-
100	25	BB30203821141150	-	BB30204821141150	-
100	30	BB30203831141150	-	BB30204831141150	-
100	40	BB30203841141150	-	BB30204841141150	-

### Height 212 cm (6 shelves and 5 LED lights)

Please contact Sales for prices on 60/30 configurations with LED.

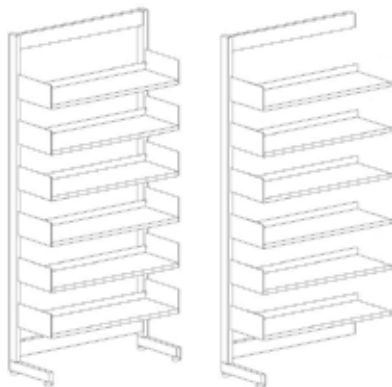

Module cm	Shelf depth cm	Item no. Starter bay	Price DKK	Item no. Add-on bay	Price DKK
75	22.5	BB30203117141160	-	BB30204117141160	-
75	25	BB30203127141160	-	BB30204127141160	-
75	30	BB30203137141160	-	BB30204137141160	-
75	40	BB30203147141160	-	BB30204147141160	-
90	22.5	BB30203119141160	-	BB30204119141160	-
90	25	BB30203129141160	-	BB30204129141160	-
90	30	BB30203139141160	-	BB30204139141160	-
90	40	BB30203149141160	-	BB30204149141160	-
100	22.5	BB30203111141160	-	BB30204111141160	-
100	25	BB30203121141160	-	BB30204121141160	-
100	30	BB30203131141160	-	BB30204131141160	-
100	40	BB30203141141160	-	BB30204141141160	-

# 60/30 CLASSIC WITH LED

## DOUBLE-SIDED - WITHOUT TOP SHELF AND WITH LED LIGHTING ON INTERMEDIATE SHELVES

Complete shelving system with uprights, cable channels, crossbars, steel shelves with backedge and LED lighting (see page 160 for details on LED lighting), brackets and fittings. Cabling from bottom (cabling from above is an option, contact sales). Number of shelves are calculated for optimal shelf spacing for fiction. The LED light is placed underneath each shelf and the cable channel is placed on the left side of the bay. A starter bay is delivered with one right and one left bracket per shelf. An add-on bay is delivered with a double bracket per shelf, which places the shelves in the same height as that of the starter bay.

### Height 92 cm (2 shelves and 1 LED light on each side)

Please contact Sales for prices on 60/30 configurations with LED.

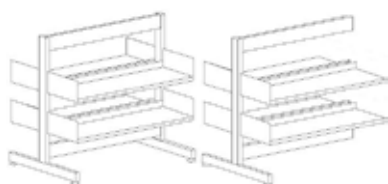

Module cm	Shelf depth cm	Item no. Starter bay	Price DKK	Item no. Add-on bay	Price DKK
75	22.5	BB30203717241120	-	BB30204717241120	-
75	25	BB30203727241120	-	BB30204727241120	-
75	30	BB30203737241120	-	BB30204737241120	-
75	40	BB30203747241120	-	BB30204747241120	-
90	22.5	BB30203719241120	-	BB30204719241120	-
90	25	BB30203729241120	-	BB30204729241120	-
90	30	BB30203739241120	-	BB30204739241120	-
90	40	BB30203749241120	-	BB30204749241120	-
100	22.5	BB30203711241120	-	BB30204711241120	-
100	25	BB30203721241120	-	BB30204721241120	-
100	30	BB30203731241120	-	BB30204731241120	-
100	40	BB30203741241120	-	BB30204741241120	-

### Height 122 cm (3 shelves and 2 LED lights on each side)

Please contact Sales for prices on 60/30 configurations with LED.

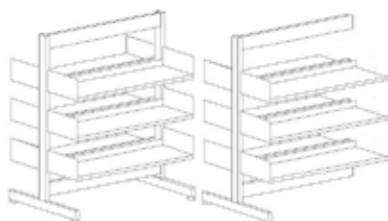

Module cm	Shelf depth cm	Item no. Starter bay	Price DKK	Item no. Add-on bay	Price DKK
75	22.5	BB30203217241130	-	BB30204217241130	-
75	25	BB30203227241130	-	BB30204227241130	-
75	30	BB30203237241130	-	BB30204237241130	-
75	40	BB30203247241130	-	BB30204247241130	-
90	22.5	BB30203219241130	-	BB30204219241130	-
90	25	BB30203229241130	-	BB30204229241130	-
90	30	BB30203239241130	-	BB30204239241130	-
90	40	BB30203249241130	-	BB30204249241130	-
100	22.5	BB30203211241130	-	BB30204211241130	-
100	25	BB30203221241130	-	BB30204221241130	-
100	30	BB30203231241130	-	BB30204231241130	-
100	40	BB30203241241130	-	BB30204241241130	-

### Height 152 cm (4 shelves and 3 LED lights on each side)

Please contact Sales for prices on 60/30 configurations with LED.

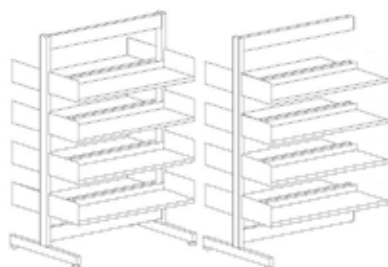

Module cm	Shelf depth cm	Item no. Starter bay	Price DKK	Item no. Add-on bay	Price DKK
75	22.5	BB30203517241140	-	BB30204517241140	-
75	25	BB30203527241140	-	BB30204527241140	-
75	30	BB30203537241140	-	BB30204537241140	-
75	40	BB30203547241140	-	BB30204547241140	-
90	22.5	BB30203519241140	-	BB30204519241140	-
90	25	BB30203529241140	-	BB30204529241140	-
90	30	BB30203539241140	-	BB30204539241140	-
90	40	BB30203549241140	-	BB30204549241140	-
100	22.5	BB30203511241140	-	BB30204511241140	-
100	25	BB30203521241140	-	BB30204521241140	-
100	30	BB30203531241140	-	BB30204531241140	-
100	40	BB30203541241140	-	BB30204541241140	-

# 60/30 CLASSIC WITH LED

## DOUBLE-SIDED - WITHOUT TOP SHELF AND WITH LED LIGHTING ON INTERMEDIATE SHELVES

Complete shelving system with uprights, cable channels, crossbars, steel shelves with backedge and LED lighting (see page 160 for details on LED lighting), brackets and fittings. Cabling from bottom (cabling from above is an option, contact sales). Number of shelves are calculated for optimal shelf spacing for fiction. The LED light is placed underneath each shelf and the cable channel is placed on the left side of the bay. A starter bay is delivered with one right and one left bracket per shelf. An add-on bay is delivered with a double bracket per shelf, which places the shelves in the same height as that of the starter bay.

### Height 182 cm (5 shelves and 4 LED lights on each side)

Please contact Sales for prices on 60/30 configurations with LED.

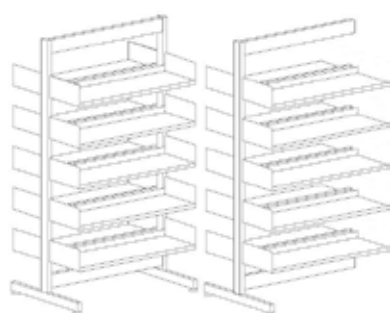

Module cm	Shelf depth cm	Item no. Starter bay	Price DKK	Item no. Add-on bay	Price DKK
75	22.5	BB30203817241150	-	BB30204817241150	-
75	25	BB30203827241150	-	BB30204827241150	-
75	30	BB30203837241150	-	BB30204837241150	-
75	40	BB30203847241150	-	BB30204847241150	-
90	22.5	BB30203819241150	-	BB30204819241150	-
90	25	BB30203829241150	-	BB30204829241150	-
90	30	BB30203839241150	-	BB30204839241150	-
90	40	BB30203849241150	-	BB30204849241150	-
100	22.5	BB30203811241150	-	BB30204811241150	-
100	25	BB30203821241150	-	BB30204821241150	-
100	30	BB30203831241150	-	BB30204831241150	-
100	40	BB30203841241150	-	BB30204841241150	-

### Height 212 cm (6 shelves and 5 LED lights on each side)

Please contact Sales for prices on 60/30 configurations with LED.

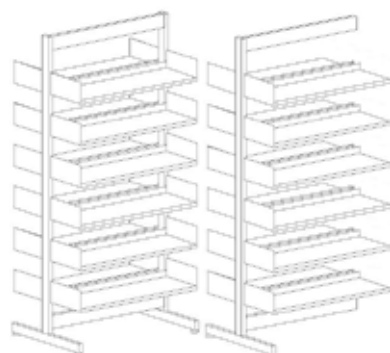

Module cm	Shelf depth cm	Item no. Starter bay	Price DKK	Item no. Add-on bay	Price DKK
75	22.5	BB30203117241160	-	BB30204117241160	-
75	25	BB30203127241160	-	BB30204127241160	-
75	30	BB30203137241160	-	BB30204137241160	-
75	40	BB30203147241160	-	BB30204147241160	-
90	22.5	BB30203119241160	-	BB30204119241160	-
90	25	BB30203129241160	-	BB30204129241160	-
90	30	BB30203139241160	-	BB30204139241160	-
90	40	BB30203149241160	-	BB30204149241160	-
100	22.5	BB30203111241160	-	BB30204111241160	-
100	25	BB30203121241160	-	BB30204121241160	-
100	30	BB30203131241160	-	BB30204131241160	-
100	40	BB30203241141160	-	BB30204241141160	-

# 60/30 CLASSIC WITH LED

## SINGLE-SIDED - WITH TOP SHELF AND LED LIGHTING ON TOP AND INTERMEDIATE SHELVES

Complete shelving system with uprights, cable channels, crossbars, steel shelves with backedge and LED lighting, top shelves with LED lighting (see page 160 for details on LED lighting), brackets, fittings and wall securement. Cabling from bottom (cabling from above is an option, contact sales). Number of shelves are calculated for optimal shelf spacing for fiction. The LED light is placed underneath each shelf and the cable channel is placed on the left side of the bay. A starter bay is delivered with one right and one left bracket per shelf. An add-on bay is delivered with a double bracket per shelf, which places the shelves in the same height as that of the starter bay.

### Height 92 cm (1 top shelf, 2 shelves and 2 LED lights)

Please contact Sales for prices on 60/30 configurations with LED.

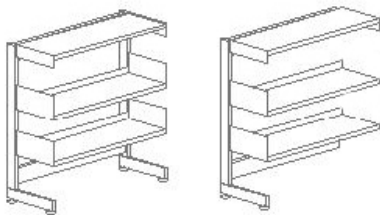

Module cm	Shelf depth cm	Item no. Starter bay	Price DKK	Item no. Add-on bay	Price DKK
75	22.5	BB30203717121121	-	BB30204717121121	-
75	25	BB30203727121121	-	BB30204727121121	-
75	30	BB30203737121121	-	BB30204737121121	-
75	40	BB30203747121121	-	BB30204747121121	-
90	22.5	BB30203719121121	-	BB30204719121121	-
90	25	BB30203729121121	-	BB30204729121121	-
90	30	BB30203739121121	-	BB30204739121121	-
90	40	BB30203749121121	-	BB30204749121121	-
100	22.5	BB30203711121121	-	BB30204711121121	-
100	25	BB30203721121121	-	BB30204721121121	-
100	30	BB30203731121121	-	BB30204731121121	-
100	40	BB30203741121121	-	BB30204741121121	-

### Height 122 cm (1 top shelf, 3 shelves and 3 LED lights)

Please contact Sales for prices on 60/30 configurations with LED.

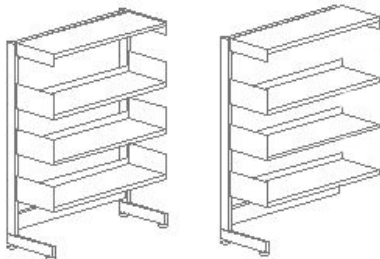

Module cm	Shelf depth cm	Item no. Starter bay	Price DKK	Item no. Add-on bay	Price DKK
75	22.5	BB30203217131131	-	BB30204217131131	-
75	25	BB30203227131131	-	BB30204227131131	-
75	30	BB30203237131131	-	BB30204237131131	-
75	40	BB30203247131131	-	BB30204247131131	-
90	22.5	BB30203219131131	-	BB30204219131131	-
90	25	BB30203229131131	-	BB30204229131131	-
90	30	BB30203239131131	-	BB30204239131131	-
90	40	BB30203249131131	-	BB30204249131131	-
100	22.5	BB30203211131131	-	BB30204211131131	-
100	25	BB30203221131131	-	BB30204221131131	-
100	30	BB30203231131131	-	BB30204231131131	-
100	40	BB30203241131131	-	BB30204241131131	-

### Height 152 cm (1 top shelf, 4 shelves and 4 LED lights)

Please contact Sales for prices on 60/30 configurations with LED.

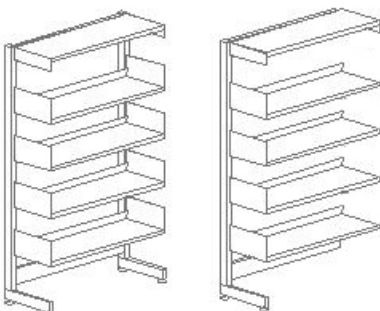

Module cm	Shelf depth cm	Item no. Starter bay	Price DKK	Item no. Add-on bay	Price DKK
75	22.5	BB30203517131141	-	BB30204517131141	-
75	25	BB30203527131141	-	BB30204527131141	-
75	30	BB30203537131141	-	BB30204537131141	-
75	40	BB30203547131141	-	BB30204547131141	-
90	22.5	BB30203519131141	-	BB30204519131141	-
90	25	BB30203529131141	-	BB30204529131141	-
90	30	BB30203539131141	-	BB30204539131141	-
90	40	BB30203549131141	-	BB30204549131141	-
100	22.5	BB30203511131141	-	BB30204511131141	-
100	25	BB30203521131141	-	BB30204521131141	-
100	30	BB30203531131141	-	BB30204531131141	-
100	40	BB30203541131141	-	BB30204541131141	-

# 60/30 CLASSIC WITH LED

## SINGLE-SIDED - WITH TOP SHELF AND LED LIGHTING ON TOP AND INTERMEDIATE SHELVES

Complete shelving system with uprights, cable channels, crossbars, steel shelves with backedge and LED lighting, top shelves with LED lighting (see page 160 for details on LED lighting), brackets, fittings and wall securement. Cabling from bottom (cabling from above is an option, contact sales). Number of shelves are calculated for optimal shelf spacing for fiction. The LED light is placed underneath each shelf and the cable channel is placed on the left side of the bay. A starter bay is delivered with one right and one left bracket per shelf. An add-on bay is delivered with a double bracket per shelf, which places the shelves in the same height as that of the starter bay.

### Height 182 cm (1 top shelf, 5 shelves and 5 LED lights )

Please contact Sales for prices on 60/30 configurations with LED.

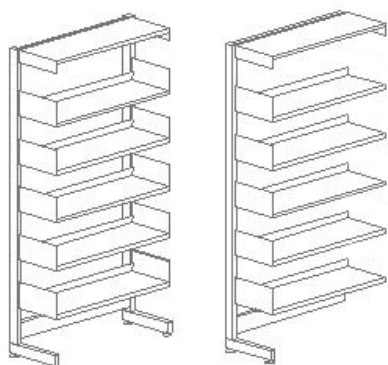

Module cm	Shelf depth cm	Item no. Starter bay	Price DKK	Item no. Add-on bay	Price DKK
75	22.5	BB30203817131151	-	BB30204817131151	-
75	25	BB30203827131151	-	BB30204827131151	-
75	30	BB30203837131151	-	BB30204837131151	-
75	40	BB30203847131151	-	BB30204847131151	-
90	22.5	BB30203819131151	-	BB30204819131151	-
90	25	BB30203829131151	-	BB30204829131151	-
90	30	BB30203839131151	-	BB30204839131151	-
90	40	BB30203849131151	-	BB30204849131151	-
100	22.5	BB30203811131151	-	BB30204811131151	-
100	25	BB30203821131151	-	BB30204821131151	-
100	30	BB30203831131151	-	BB30204831131151	-
100	40	BB30203841131151	-	BB30204841131151	-

### Height 212 cm (1 top shelf, 6 shelves and 6 LED lights)

Please contact Sales for prices on 60/30 configurations with LED.

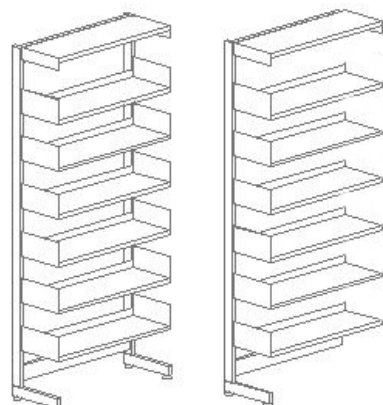

Module cm	Shelf depth cm	Item no. Starter bay	Price DKK	Item no. Add-on bay	Price DKK
75	22.5	BB30203117131161	-	BB30204117131161	-
75	25	BB30203127131161	-	BB30204127131161	-
75	30	BB30203137131161	-	BB30204137131161	-
75	40	BB30203147131161	-	BB30204147131161	-
90	22.5	BB30203119131161	-	BB30204119131161	-
90	25	BB30203129131161	-	BB30204129131161	-
90	30	BB30203139131161	-	BB30204139131161	-
90	40	BB30203149131161	-	BB30204149131161	-
100	22.5	BB30203111131161	-	BB30204111131161	-
100	25	BB30203121131161	-	BB30204121131161	-
100	30	BB30203131131161	-	BB30204131131161	-
100	40	BB30203141131161	-	BB30204141131161	-

# 60/30 CLASSIC WITH LED

## DOUBLE-SIDED - WITH TOP SHELF AND LED LIGHTING ON TOP AND INTERMEDIATE SHELVES

Complete shelving system with uprights, cable channels, crossbars, steel shelves with backedge and LED lighting, top shelves with LED lighting (see page 160 for details on LED lighting), brackets and fittings. Cabling from bottom (cabling from above is an option, contact sales). Number of shelves are calculated for optimal shelf spacing for fiction. The LED light is placed underneath each shelf and the cable channel is placed on the left side of the bay. A starter bay is delivered with one right and one left bracket per shelf. An add-on bay is delivered with a double bracket per shelf, which places the shelves in the same height as that of the starter bay.

### Height 92 cm (1 top shelf, 2 shelves and 2 LED lights on each side)

Please contact Sales for prices on 60/30 configurations with LED.

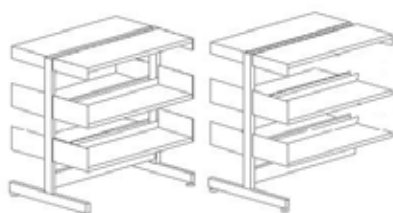

Module cm	Shelf depth cm	Item no. Starter bay	Price DKK	Item no. Add-on bay	Price DKK
75	22.5	BB30203717231121	-	BB30204717231121	-
75	25	BB30203727231121	-	BB30204727231121	-
75	30	BB30203737231121	-	BB30204737231121	-
75	40	BB30203747231121	-	BB30204747231121	-
90	22.5	BB30203719231121	-	BB30204719231121	-
90	25	BB30203729231121	-	BB30204729231121	-
90	30	BB30203739231121	-	BB30204739231121	-
90	40	BB30203749231121	-	BB30204749231121	-
100	22.5	BB30203711231121	-	BB30204711231121	-
100	25	BB30203721231121	-	BB30204721231121	-
100	30	BB30203731231121	-	BB30204731231121	-
100	40	BB30203741231121	-	BB30204741231121	-

### Height 122 cm (1 top shelf, 3 shelves and 3 LED lights on each side)

Please contact Sales for prices on 60/30 configurations with LED.

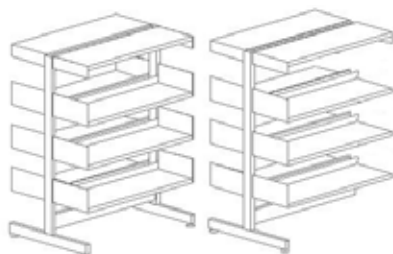

Module cm	Shelf depth cm	Item no. Starter bay	Price DKK	Item no. Add-on bay	Price DKK
75	22.5	BB30203217231131	-	BB30204217231131	-
75	25	BB30203227231131	-	BB30204227231131	-
75	30	BB30203237231131	-	BB30204237231131	-
75	40	BB30203247231131	-	BB30204247231131	-
90	22.5	BB30203219231131	-	BB30204219231131	-
90	25	BB30203229231131	-	BB30204229231131	-
90	30	BB30203239231131	-	BB30204239231131	-
90	40	BB30203249231131	-	BB30204249231131	-
100	22.5	BB30203211231131	-	BB30204211231131	-
100	25	BB30203221231131	-	BB30204221231131	-
100	30	BB30203231231131	-	BB30204231231131	-
100	40	BB30203241231131	-	BB30204241231131	-

### Height 152 cm (1 top shelf, 4 shelves and 4 LED lights on each side)

Please contact Sales for prices on 60/30 configurations with LED.

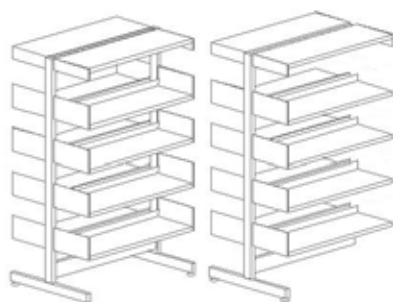

Module cm	Shelf depth cm	Item no. Starter bay	Price DKK	Item no. Add-on bay	Price DKK
75	22.5	BB30203517231141	-	BB30204517231141	-
75	25	BB30203527231141	-	BB30204527231141	-
75	30	BB30203537231141	-	BB30204537231141	-
75	40	BB30203547231141	-	BB30204547231141	-
90	22.5	BB30203519231141	-	BB30204519231141	-
90	25	BB30203529231141	-	BB30204529231141	-
90	30	BB30203539231141	-	BB30204539231141	-
90	40	BB30203549231141	-	BB30204549231141	-
100	22.5	BB30203511231141	-	BB30204511231141	-
100	25	BB30203521231141	-	BB30204521231141	-
100	30	BB30203531231141	-	BB30204531231141	-
100	40	BB30203541231141	-	BB30204541231141	-



# 60/30 CLASSIC WITH LED

## DOUBLE-SIDED - WITH TOP SHELF AND LED LIGHTING ON TOP AND INTERMEDIATE SHELVES

Complete shelving system with uprights, cable channels, crossbars, steel shelves with backedge and LED lighting, top shelves with LED lighting (see page 160 for details on LED lighting), brackets and fittings. Cabling from bottom (cabling from above is an option, contact sales). Number of shelves are calculated for optimal shelf spacing for fiction. The LED light is placed underneath each shelf and the cable channel is placed on the left side of the bay. A starter bay is delivered with one right and one left bracket per shelf. An add-on bay is delivered with a double bracket per shelf, which places the shelves in the same height as that of the starter bay.

### Height 182 cm (1 top shelf, 5 shelves and 5 LED lights on each side)

Please contact Sales for prices on 60/30 configurations with LED.

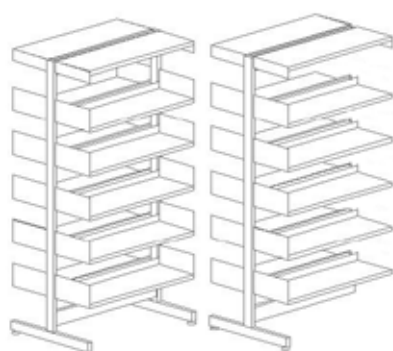

Module cm	Shelf depth cm	Item no. Starter bay	Price DKK	Item no. Add-on bay	Price DKK
75	22.5	BB30203817231151	-	BB30204817231151	-
75	25	BB30203827231151	-	BB30204827231151	-
75	30	BB30203837231151	-	BB30204837231151	-
75	40	BB30203847231151	-	BB30204847231151	-
90	22.5	BB30203819231151	-	BB30204819231151	-
90	25	BB30203829231151	-	BB30204829231151	-
90	30	BB30203839231151	-	BB30204839231151	-
90	40	BB30203849231151	-	BB30204849231151	-
100	22.5	BB30203811231151	-	BB30204811231151	-
100	25	BB30203821231151	-	BB30204821231151	-
100	30	BB30203831231151	-	BB30204831231151	-
100	40	BB30203841231151	-	BB30204841231151	-

### Height 212 cm (1 top shelf, 6 shelves and 6 LED lights on each side)

Please contact Sales for prices on 60/30 configurations with LED.

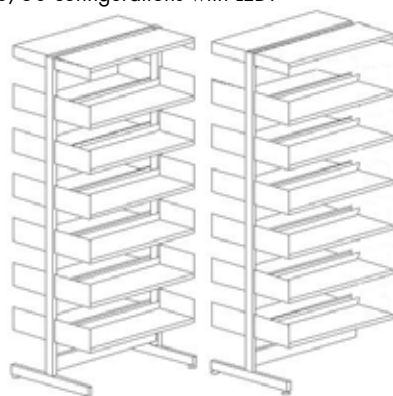

Module cm	Shelf depth cm	Item no. Starter bay	Price DKK	Item no. Add-on bay	Price DKK
75	22.5	BB30203117231161	-	BB30204117231161	-
75	25	BB30203127231161	-	BB30204127231161	-
75	30	BB30203137231161	-	BB30204137231161	-
75	40	BB30203147231161	-	BB30204147231161	-
90	22.5	BB30203119231161	-	BB30204119231161	-
90	25	BB30203129231161	-	BB30204129231161	-
90	30	BB30203139231161	-	BB30204139231161	-
90	40	BB30203149231161	-	BB30204149231161	-
100	22.5	BB30203111231161	-	BB30204111231161	-
100	25	BB30203121231161	-	BB30204121231161	-
100	30	BB30203131231161	-	BB30204131231161	-
100	40	BB30203141231161	-	BB30204141231161	-



# 80/30 CLASSIC STEEL SHELVING

The following pages will show basic configurations of the 60/30 Classic Steel Shelving system based on 80/30 upright installations. The wider construction of this upright allows for greater total weight and also a taller construction.





# 80/30 CLASSIC STEEL SHELVING

## SINGLE-SIDED - WITH TOP SHELF

Complete shelving system with uprights, crossbars, shelves, top shelf, brackets, fittings and wall securement. Shelves are steel shelves with backedge, top shelf is steel shelf without backedge. Number of shelves are calculated for optimal shelf spacing for fiction. A starter bay is delivered with one right and one left bracket per shelf. An add-on bay is delivered with a double bracket per shelf, which places the shelves in the same height as that of the starter bay. Please note that standard end panels do not fit on 80/30 steel shelving and must be ordered specially, please contact customer service.

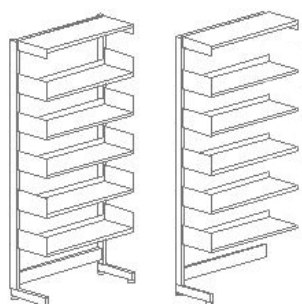
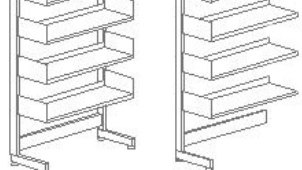

### Height 199 cm (5 shelves + top shelf)

	Module cm	Shelf depth cm	Price DKK	
			Item no. Starter bay	Item no. Add-on bay
	75	22.5	BB304003171151	5.479
	75	25	BB304003271151	5.672
	75	30	BB304003371151	5.946
	75	40	BB304003471151	6.634
	90	22.5	BB304003191151	5.773
	90	25	BB304003291151	5.919
	90	30	BB304003391151	6.229
	90	40	BB304003491151	7.233
	100	22.5	BB304003111151	6.127
	100	25	BB304003211151	6.327
	100	30	BB304003311151	6.593
	100	40	BB304003411151	7.464

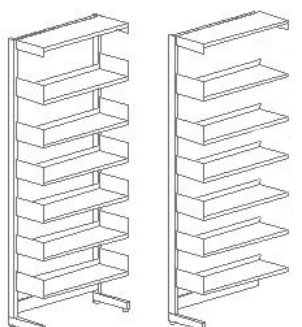
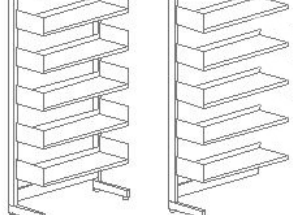
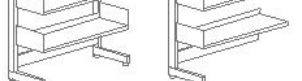
### Height 229 cm (6 shelves + top shelf)

	Module cm	Shelf depth cm	Price DKK	
			Item no. Starter bay	Item no. Add-on bay
	75	22.5	BB304002171161	6.052
	75	25	BB304002271161	6.277
	75	30	BB304002371161	6.581
	75	40	BB304002471161	7.390
	90	22.5	BB304002191161	6.386
	90	25	BB304002291161	6.548
	90	30	BB304002391161	6.900
	90	40	BB304002491161	8.078
	100	22.5	BB304002111161	6.780
	100	25	BB304002211161	7.009
	100	30	BB304002311161	7.310
	100	40	BB304002411161	8.331

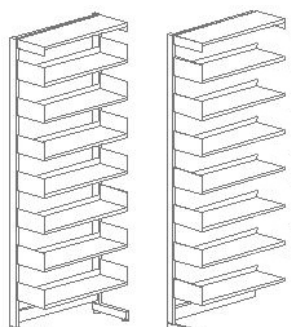
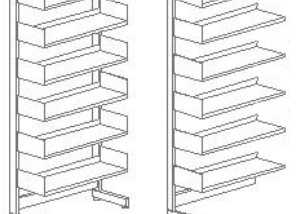
### Height 259 cm (7 shelves + top shelf)

	Module cm	Shelf depth cm	Price DKK	
			Item no. Starter bay	Item no. Add-on bay
	75	22.5	BB304001171171	6.608
	75	25	BB304001271171	6.875
	75	30	BB304001371171	7.218
	75	40	BB304001471171	8.132
	90	22.5	BB304001191171	6.982
	90	25	BB304001291171	7.170
	90	30	BB304001391171	7.573
	90	40	BB304001491171	8.909
	100	22.5	BB304001111171	7.416
	100	25	BB304001211171	7.684
	100	30	BB304001311171	8.029
	100	40	BB304001411171	9.184

# 80/30 CLASSIC STEEL SHELVING

## DOUBLE-SIDED - WITH TOP SHELF

Complete shelving system with uprights, crossbars, shelves, top shelf, brackets and fittings. Shelves are steel shelves with backedge, top shelf is steel shelf without backedge. Number of shelves are calculated for optimal shelf spacing for fiction. A starter bay is delivered with one right and one left bracket per shelf. An add-on bay is delivered with a double bracket per shelf, which places the shelves in the same height as that of the starter bay. Please note that standard end panels do not fit on 80/30 steel shelving and must be ordered specially, please contact customer service.

### Height 199 cm (5 shelves + top shelf on each side)

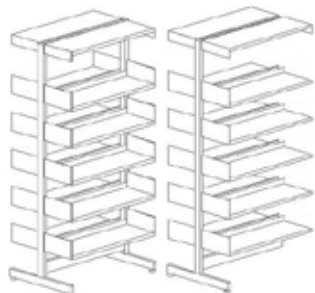
	Module cm	Shelf depth cm	Item no.		Price	
			Starter bay	Add-on bay	DKK	DKK
	75	22.5	BB304003172151	BB304013172151	11.924	8.565
	75	25	BB304003272151	BB304013272151	12.708	9.017
	75	30	BB304003372151	BB304013372151	13.116	9.461
	75	40	BB304003472151	BB304013472151	14.922	10.903
	90	22.5	BB304003192151	BB304013192151	12.472	9.073
	90	25	BB304003292151	BB304013292151	13.162	9.431
	90	30	BB304003392151	BB304013392151	13.642	9.947
	90	40	BB304003492151	BB304013492151	16.080	12.021
	100	22.5	BB304003112151	BB304013112151	13.136	9.693
	100	25	BB304003212151	BB304013212151	13.934	10.159
	100	30	BB304003312151	BB304013312151	14.326	10.587
	100	40	BB304003412151	BB304013412151	16.498	12.395

### Height 229 cm (6 shelves + top shelf on each side)

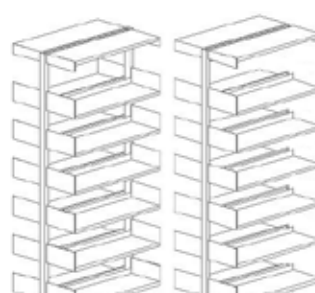
	Module cm	Shelf depth cm	Item no.		Price	
			Starter bay	Add-on bay	DKK	DKK
	75	22.5	BB304002172161	BB304012172161	13.252	9.622
	75	25	BB304002272161	BB304012272161	13.946	10.039
	75	30	BB304002372161	BB304012372161	14.582	10.632
	75	40	BB304002472161	BB304012472161	16.676	12.311
	90	22.5	BB304002192161	BB304012192161	13.880	10.210
	90	25	BB304002292161	BB304012292161	14.448	10.501
	90	30	BB304002392161	BB304012392161	15.180	11.190
	90	40	BB304002492161	BB304012492161	18.012	13.607
	100	22.5	BB304002112161	BB304012112161	14.624	10.910
	100	25	BB304002212161	BB304012212161	15.326	11.335
	100	30	BB304002312161	BB304012312161	15.956	11.922
	100	40	BB304002412161	BB304012412161	18.474	14.025

### Height 259 cm (7 shelves + top shelf on each side)

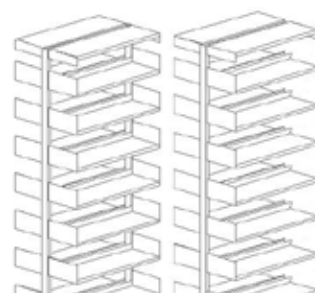
	Module cm	Shelf depth cm	Item no.		Price	
			Starter bay	Add-on bay	DKK	DKK
	75	22.5	BB304001172171	BB304011172171	14.552	10.665
	75	25	BB304001272171	BB304011272171	15.386	11.162
	75	30	BB304001372171	BB304011372171	16.084	11.821
	75	40	BB304001472171	BB304011472171	18.436	13.722
	90	22.5	BB304001192171	BB304011192171	15.260	11.333
	90	25	BB304001292171	BB304011292171	15.936	11.672
	90	30	BB304001392171	BB304011392171	16.754	12.451
	90	40	BB304001492171	BB304011492171	19.950	15.196
	100	22.5	BB304001112171	BB304011112171	16.084	12.113
	100	25	BB304001212171	BB304011212171	16.920	12.612
	100	30	BB304001312171	BB304011312171	17.622	13.275
	100	40	BB304001412171	BB304011412171	20.456	15.658



# 60/30 CLASSIC STEEL SHELVING - WALL

The following pages will show basic configurations of the 60/30 Classic Steel Shelving system based on 60/30 Classic wall strip installations.



# CLASSIC STEEL SHELVING - WALL

## WITH TOP SHELF

Complete shelving system with wall strips, shelves, top shelf, brackets and fittings. Shelves are steel shelves with backedge, top shelf is steel shelf without backedge. Number of shelves are calculated for optimal shelf spacing for fiction. A starter bay is delivered with one right and one left bracket per shelf. An add-on bay is delivered with a double bracket per shelf, which places the shelves in the same height as that of the starter bay. Please note that standard end panels do not fit on 60/30 wall steel shelving and must be ordered specially, please contact customer service.

### Height 112.5 cm (3 shelves + top shelf)

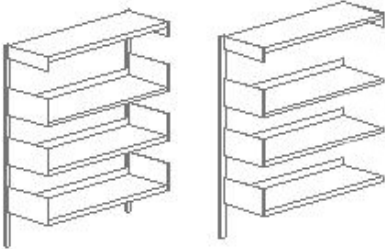
	Module cm	Shelf depth cm	Item no. Starter bay	Price DKK	Item no. Add-on bay	Price DKK
	75	22.5	BB302001117131	2.700	BB302011117131	2.144
	75	25	BB302001127131	2.866	BB302011127131	2.247
	75	30	BB302001137131	3.030	BB302011137131	2.414
	75	40	BB302001147131	3.529	BB302011147131	2.840
	90	22.5	BB302001119131	2.834	BB302011119131	2.278
	90	25	BB302001129131	2.985	BB302011129131	2.366
	90	30	BB302001139131	3.161	BB302011139131	2.545
	90	40	BB302001149131	3.870	BB302011149131	3.181
	100	22.5	BB302001111131	3.020	BB302011111131	2.464
	100	25	BB302001121131	3.199	BB302011121131	2.580
	100	30	BB302001131131	3.345	BB302011131131	2.729
	100	40	BB302001141131	3.969	BB302011141131	3.280

### Height 142.5 cm (4 shelves + top shelf)

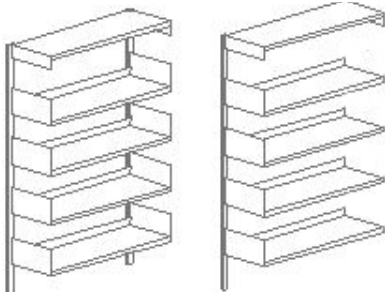
	Module cm	Shelf depth cm	Item no. Starter bay	Price DKK	Item no. Add-on bay	Price DKK
	75	22.5	BB302001417141	3.377	BB302011417141	2.679
	75	25	BB302001427141	3.595	BB302011427141	2.813
	75	30	BB302001437141	3.792	BB302011437141	3.014
	75	40	BB302001447141	4.426	BB302011447141	3.554
	90	22.5	BB302001419141	3.551	BB302011419141	2.853
	90	25	BB302001429141	3.738	BB302011429141	2.956
	90	30	BB302001439141	3.959	BB302011439141	3.181
	90	40	BB302001449141	4.856	BB302011449141	3.984
	100	22.5	BB302001411141	3.777	BB302011411141	3.079
	100	25	BB302001421141	4.005	BB302011421141	3.223
	100	30	BB302001431141	4.189	BB302011431141	3.411
	100	40	BB302001441141	4.977	BB302011441141	4.105



# CLASSIC STEEL SHELVING - WALL

WITH TOP SHELF

Complete shelving system with wall strips, shelves, top shelf, brackets and fittings. Shelves are steel shelves with backedge, top shelf is steel shelf without backedge. Number of shelves are calculated for optimal shelf spacing for fiction. A starter bay is delivered with one right and one left bracket per shelf. An add-on bay is delivered with a double bracket per shelf, which places the shelves in the same height as that of the starter bay. Please note that standard end panels do not fit on 60/30 wall steel shelving and must be ordered specially, please contact customer service.

## Height 172.5 cm (5 shelves + top shelf)

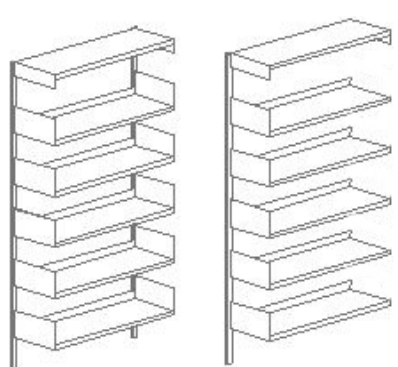
	Module cm	Shelf depth cm	Item no. Starter bay	Price DKK	Item no. Add-on bay	Price DKK
	75	22.5	BB302001717151	4.014	BB302011717151	3.194
	75	25	BB302001727151	4.284	BB302011727151	3.359
	75	30	BB302001737151	4.514	BB302011737151	3.594
	75	40	BB302001747151	5.283	BB302011747151	4.248
	90	22.5	BB302001719151	4.228	BB302011719151	3.408
	90	25	BB302001729151	4.451	BB302011729151	3.526
	90	30	BB302001739151	4.717	BB302011739151	3.797
	90	40	BB302001749151	5.802	BB302011749151	4.767
	100	22.5	BB302001711151	4.494	BB302011711151	3.674
	100	25	BB302001721151	4.771	BB302011721151	3.846
	100	30	BB302001731151	4.993	BB302011731151	4.073
	100	40	BB302001741151	5.945	BB302011741151	4.910

## Height 202.5 cm (6 shelves + top shelf)

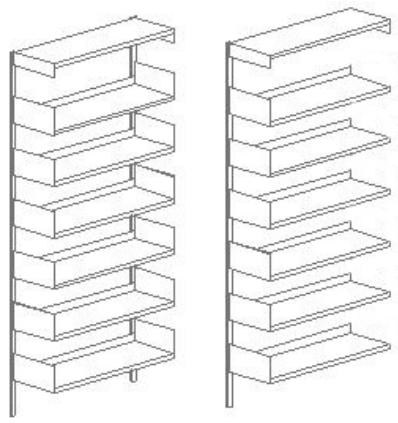
	Module cm	Shelf depth cm	Item no. Starter bay	Price DKK	Item no. Add-on bay	Price DKK
	75	22.5	BB302002017161	4.657	BB302012017161	3.712
	75	25	BB302002027161	4.979	BB302012027161	3.908
	75	30	BB302002037161	5.242	BB302012037161	4.177
	75	40	BB302002047161	6.146	BB302012047161	4.945
	90	22.5	BB302002019161	4.911	BB302012019161	3.966
	90	25	BB302002029161	5.170	BB302012029161	4.099
	90	30	BB302002039161	5.481	BB302012039161	4.416
	90	40	BB302002049161	6.754	BB302012049161	5.553
	100	22.5	BB302002011161	5.217	BB302012011161	4.272
	100	25	BB302002021161	5.543	BB302012021161	4.472
	100	30	BB302002031161	5.803	BB302012031161	4.738
	100	40	BB302002041161	6.919	BB302012041161	5.718

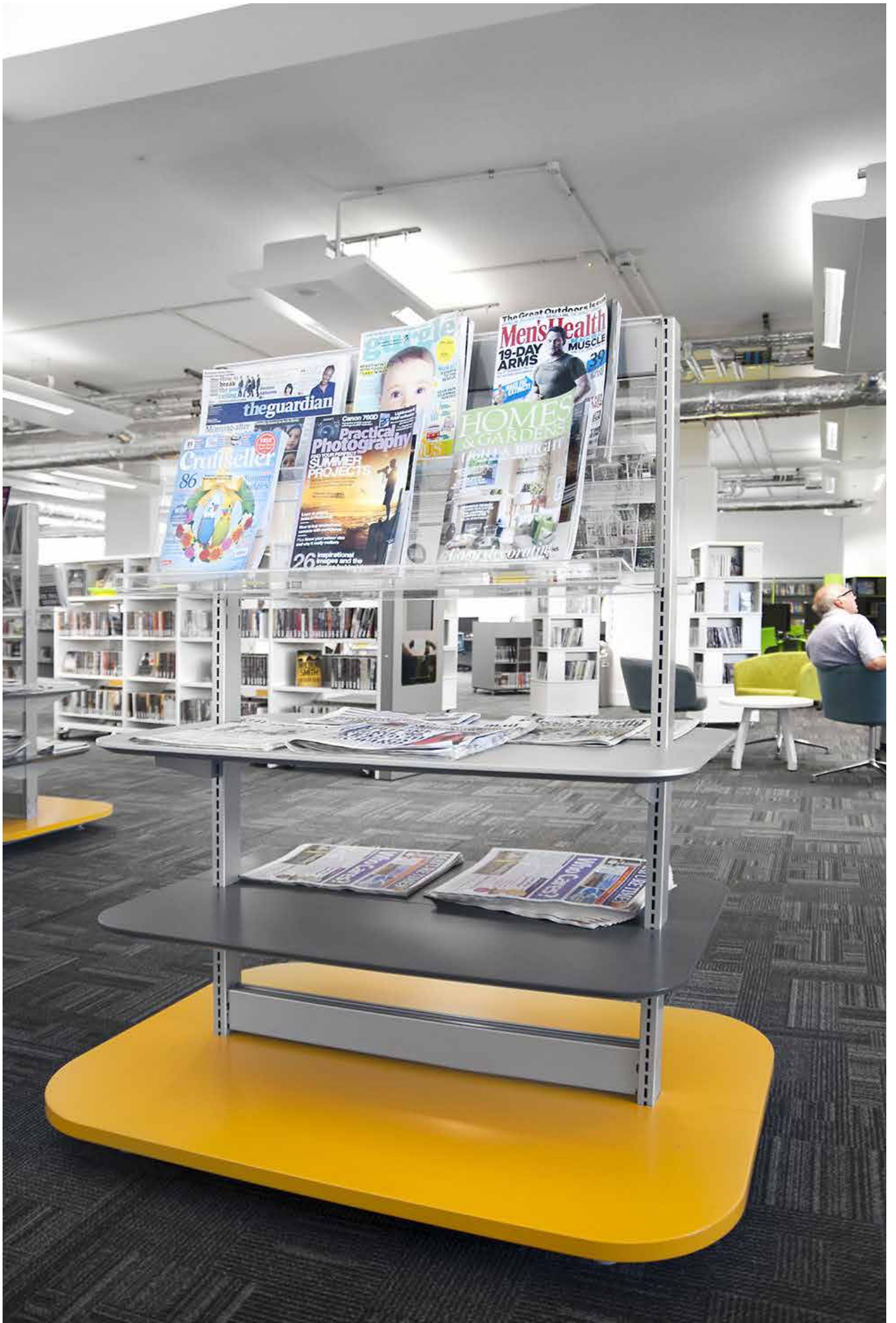

On the following pages you will find a selection of 60/30 Expo configurations including prices and lists of components included in the specific configuration. Please note that other configurations are available.

60/30 Expo is available as double-sided over a maximum of 3 bays. It consists of components, which are used for the 60/30 Classic shelving configurations along with a series of specific 60/30 Expo components. 60/30 Expo is made of steel uprights, painted wooden shelves and acrylic display shelves. The steel uprights and painted wooden shelves are available in all our standard colours. Note that wooden shelves cannot be placed next to an acrylic shelf and wooden shelves cannot be placed in front of back panels.

## Acrylic display shelf

Shelf depth cm	Item no.	Price DKK
30	B30850039	2.393

## Bracket for shelf

Shelf depth cm	Item no. Starter bay	Price DKK
30	B3085043	49

## Double-sided bottom shelf with round corners



No. of bays	Item no. Painted	Price DKK
1	B308505392155	4.522
2	B308505392255	7.208
3	B308505392355	9.804

## Double-sided shelf with round corners



No. of bays	Item no. Painted	Price DKK
1	B308508392155	3.501
2	B308508392255	5.064
3	B308508392355	7.489

## Double-sided shelf for back panel with round corners



No. of bays	Item no. Painted	Price DKK
1	B308511392145	2.845
2	B308511392245	4.066

## Castors

H9.9 cm.

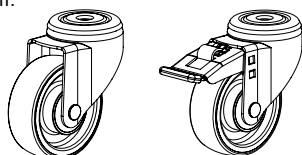

Brakes	Item no.	Price DKK
Without	B3060000	390
With	B3060001	543

# 60/30 EXPO

DOUBLE-SIDED - H122 CM - 1 BAY

Height 122 cm - 1 bay

Module 90 cm / depth 30 cm

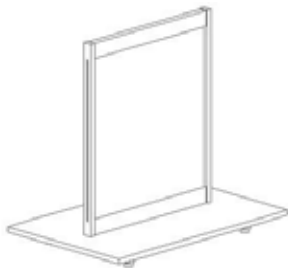

The configurations consist of the following components:

Component	Round corners Item no.	Quantity
Upright	B301000232	2
Crossbar	B3010129	2
Back panel	B301900295	1
Bottom shelf	B30850539215	1

Round corners Configuration	Price DKK
Expo 34	9.554

Height 122 cm - 1 bay

Module 90 cm / depth 30 cm

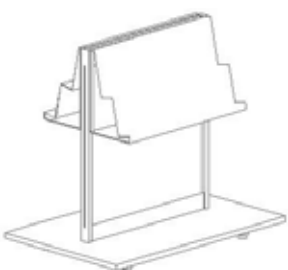

The configurations consist of the following components:

Component	Round corners Item no.	Quantity
Upright	B301000232	2
Crossbar	B3010129	2
Back panel	B301900295	1
Bottom shelf	B30850539215	1
Acrylic display shelf	B30850039	2

Round corners Configuration	Price DKK
Expo 35	14.340

Height 122 cm - 1 bay

Module 90 cm / depth 30 cm

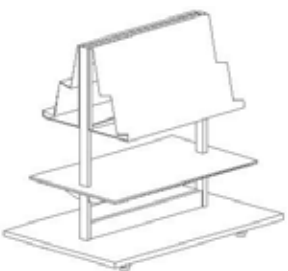

The configurations consist of the following components:

Component	Round corners Item no.	Quantity
Upright	B301000232	2
Crossbar	B3010129	2
Bottom shelf	B30850539215	1
Acrylic display shelf	B30850039	2
Shelf	B30850839215	1
Bracket for shelf	B3085043	4

Round corners Configuration	Price DKK
Expo 36	16.507

Height 122 cm - 1 bay

Module 90 cm / depth 30 cm

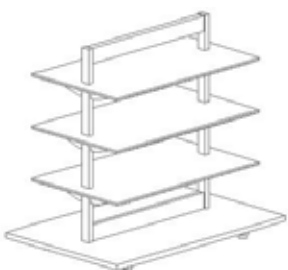

The configurations consist of the following components:

Component	Round corners Item no.	Quantity
Upright	B301000232	2
Crossbar	B3010129	2
Bottom shelf	B30850539215	1
Shelf	B30850839215	3
Bracket for shelf	B3085043	12

Round corners Configuration	Price DKK
Expo 37	19.115

# 60/30 EXPO

DOUBLE-SIDED - H122 CM - 2 BAYS

Height 122 cm - 2 bays

Module 90 cm / depth 30 cm

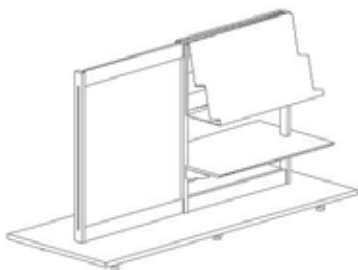

The configurations consist of the following components:

Component	Round corners Item no.	Quantity
Upright	B301000232	3
Crossbar	B3010129	4
Back panel	B301900295	1
Bottom shelf	B30850539225	1
Acrylic display shelf	B30850039	2
Shelf	B30851139214	1
Bracket for shelf	B3085043	4

Round corners Configuration	Price DKK
Expo 38	22.316

Height 122 cm - 2 bays

Module 90 cm / depth 30 cm

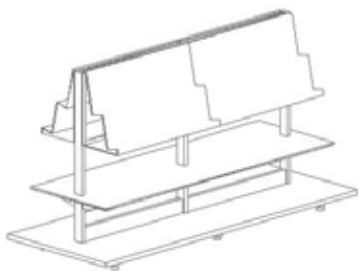

The configurations consist of the following components:

Component	Round corners Item no.	Quantity
Upright	B301000232	3
Crossbar	B3010129	4
Bottom shelf	B30850539225	1
Acrylic display shelf	B30850039	4
Shelf	B30850839225	1
Bracket for shelf	B3085043	6

Round corners Configuration	Price DKK
Expo 39	27.889

Height 122 cm - 2 bays

Module 90 cm / depth 30 cm

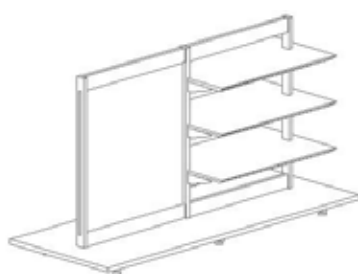

The configurations consist of the following components:

Component	Round corners Item no.	Quantity
Upright	B301000232	3
Crossbar	B3010129	4
Back panel	B301900295	1
Bottom shelf	B30850539225	1
Shelf	B30851139214	3
Bracket for shelf	B3085043	12

Round corners Configuration	Price DKK
Expo 40	23.612

Height 122 cm - 2 bays

Module 90 cm / depth 30 cm

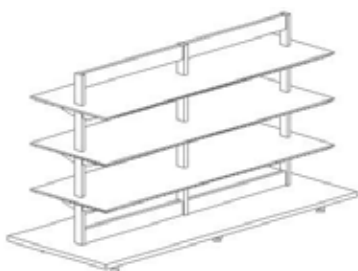

The configurations consist of the following components:

Component	Round corners Item no.	Quantity
Upright	B301000232	3
Crossbar	B3010129	4
Bottom shelf	B30850539225	1
Shelf	B30850839225	3
Bracket for shelf	B3085043	18

Round corners Configuration	Price DKK
Expo 41	29.033

# 60/30 EXPO

DOUBLE-SIDED - H122 CM - 3 BAYS

Height 122 cm - 3 bays

Module 90 cm / depth 30 cm

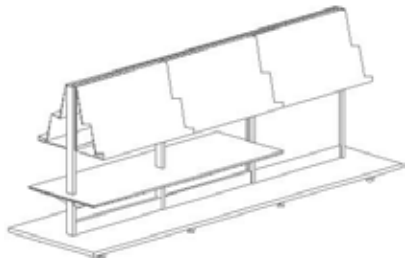

The configurations consist of the following components:

Component	Round corners Item no.	Quantity
Upright	B301000232	4
Crossbar	B3010129	6
Back panel	B301900295	1
Bottom shelf	B30850539235	1
Acrylic display shelf	B30850039	6
Shelf	B30851139224	1
Bracket for shelf	B3085043	6

Round corners Configuration	Price DKK
Expo 42	38.052

Height 122 cm - 3 bays

Module 90 cm / depth 30 cm

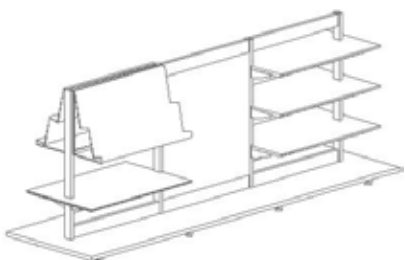

The configurations consist of the following components:

Component	Round corners Item no.	Quantity
Upright	B301000232	4
Crossbar	B3010129	6
Back panel	B301900295	1
Bottom shelf	B30850539235	1
Acrylic display shelf	B30850039	2
Shelf	B30851139224	4
Bracket for shelf	B3085043	16

Round corners Configuration	Price DKK
Expo 43	41.168

Height 122 cm - 3 bays

Module 90 cm / depth 30 cm

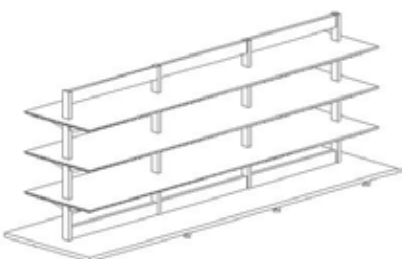

The configurations consist of the following components:

Component	Round corners Item no.	Quantity
Upright	B301000232	4
Crossbar	B3010129	6
Bottom shelf	B30850539235	1
Shelf	B30850839235	3
Bracket for shelf	B3085043	24

Round corners Configuration	Price DKK
Expo 44	41.447

# 60/30 EXPO

DOUBLE-SIDED - H152 CM - 1 BAY

## Height 152 cm - 1 bay

Module 90 cm / depth 30 cm

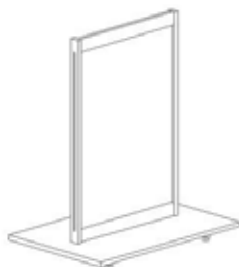

The configurations consist of the following components:

Component	Round corners Item no.	Quantity
Upright	B301000532	2
Crossbar	B3010129	2
Back panel	B301900595	1
Bottom shelf	B30850539215	1

Round corners Configuration	Price DKK
Expo 81	10.281

## Height 152 cm - 1 bay

Module 90 cm / depth 30 cm

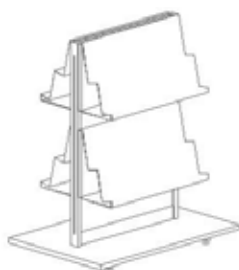

The configurations consist of the following components:

Component	Round corners Item no.	Quantity
Upright	B301000532	2
Crossbar	B3010129	2
Back panel	B301900595	1
Bottom shelf	B30850539215	1
Acrylic display shelf	B30850039	4

Round corners Configuration	Price DKK
Expo 82	19.853

## Height 152 cm - 1 bay

Module 90 cm / depth 30 cm

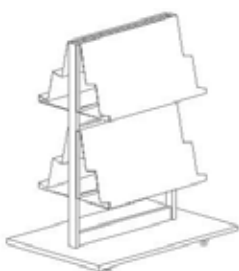

The configurations consist of the following components:

Component	Round corners Item no.	Quantity
Upright	B301000532	2
Crossbar	B3010129	2
Bottom shelf	B30850539215	1
Acrylic display shelf	B30850039	4

Round corners Configuration	Price DKK
Expo 83	17.832

## Height 152 cm - 1 bay

Module 90 cm / depth 30 cm



The configurations consist of the following components:

Component	Round corners Item no.	Quantity
Upright	B301000532	2
Crossbar	B3010129	2
Bottom shelf	B30850539215	1
Acrylic display shelf	B30850039	2
Shelf	B30850839215	2
Bracket for shelf	B3085043	8

Round corners Configuration	Price DKK
Expo 84	20.440

# 60/30 EXPO

## DOUBLE-SIDED - H152 CM - 1 & 2 BAYS

Height 152 cm - 1 bay

Module 90 cm / depth 30 cm



The configurations consist of the following components:

Component	Round corners Item no.	Quantity
Upright	B301000532	2
Crossbar	B3010129	2
Bottom shelf	B30850539215	1
Shelf	B30850839215	4
Bracket for shelf	B3085043	16

Round corners Configuration	Price DKK
Expo 85	23.048

Height 152 cm - 2 bays

Module 90 cm / depth 30 cm

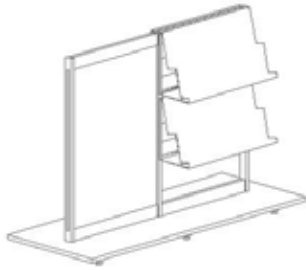

The configurations consist of the following components:

Component	Round corners Item no.	Quantity
Upright	B301000532	3
Crossbar	B3010129	4
Back panel	B301900595	1
Bottom shelf	B30850539225	1
Acrylic display shelf	B30850039	4

Round corners Configuration	Price DKK
Expo 86	24.906

Height 152 cm - 2 bays

Module 90 cm / depth 30 cm

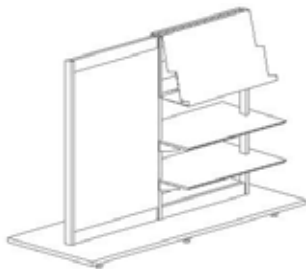

The configurations consist of the following components:

Component	Round corners Item no.	Quantity
Upright	B301000532	3
Crossbar	B3010129	4
Bottom shelf	B30850539225	1
Acrylic display shelf	B30850039	2
Shelf	B30851139214	2
Bracket for shelf	B3085043	8

Round corners Configuration	Price DKK
Expo 87	24.181

Height 152 cm - 2 bays

Module 90 cm / depth 30 cm

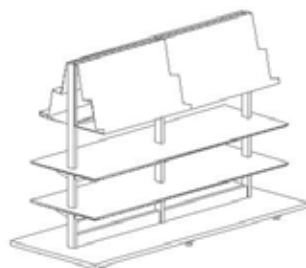

The configurations consist of the following components:

Component	Round corners Item no.	Quantity
Upright	B301000532	3
Crossbar	B3010129	4
Bottom shelf	B30850539225	1
Acrylic display shelf	B30850039	4
Shelf	B30850839225	2
Bracket for shelf	B3085043	12

Round corners Configuration	Price DKK
Expo 88	33.601



# 60/30 EXPO

DOUBLE-SIDED - H152 CM - 2 & 3 BAYS

## Height 152 cm - 2 bays

Module 90 cm / depth 30 cm

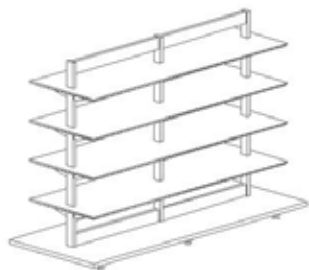

The configurations consist of the following components:

Component	Round corners Item no.	Quantity
Upright	B301000532	3
Crossbar	B3010129	4
Bottom shelf	B30850539225	1
Shelf	B30850839225	4
Bracket for shelf	B3085043	24

Round corners Configuration	Price DKK
Expo 89	34.745

## Height 152 cm - 3 bays

Module 90 cm / depth 30 cm

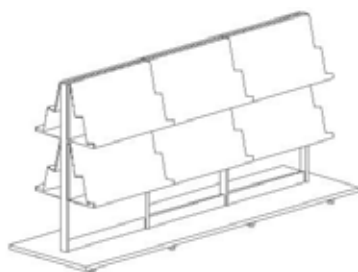

The configurations consist of the following components:

Component	Round corners Item no.	Quantity
Upright	B301000532	4
Crossbar	B3010129	6
Back panel	B301900595	1
Bottom shelf	B30850539235	1
Acrylic display shelf	B30850039	12

Round corners Configuration	Price DKK
Expo 90	49.013

## Height 152 cm - 3 bays

Module 90 cm / depth 30 cm

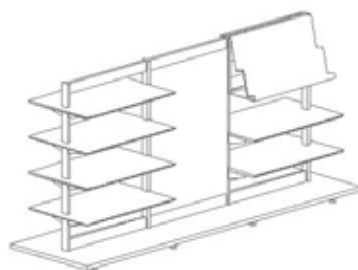

The configurations consist of the following components:

Component	Round corners Item no.	Quantity
Upright	B301000532	4
Crossbar	B3010129	6
Back panel	B301900595	1
Bottom shelf	B30850539235	1
Acrylic display shelf	B30850039	2
Shelf	B30851139214	6
Bracket for shelf	B3085043	24

Round corners Configuration	Price DKK
Expo 91	43.329

## Height 152 cm - 3 bays

Module 90 cm / depth 30 cm

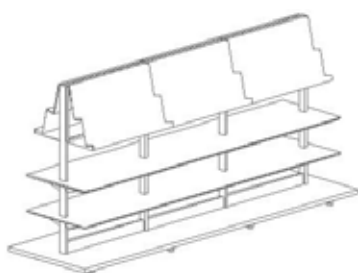

The configurations consist of the following components:

Component	Round corners Item no.	Quantity
Upright	B301000532	4
Crossbar	B3010129	6
Bottom shelf	B30850539235	1
Acrylic display shelf	B30850039	6
Shelf	B30850839235	2
Bracket for shelf	B3085043	16

Round corners Configuration	Price DKK
Expo 92	48.396

# SHELVES

## S1 & S2 STEEL SHELVES

See below for overview of standard steel shelves:

---

### B401001 - S1 STEEL SHELF WITH STEEL BACKEDGE - FOR BACKEDGE BOOK SUPPORT

Details:

- Module 750/900/1000 mm
- Depth 225/250/300/400 mm
- Steel backedge H47 mm
- Backedge book support
- Steel plate brackets
- Max. weight 80 kg.
- Straight, 45°/60° sloping & 7,5° reverse tilted
- Use with steel top shelf B401003, B401011, B301049, B301049 and wooden top shelf B401020

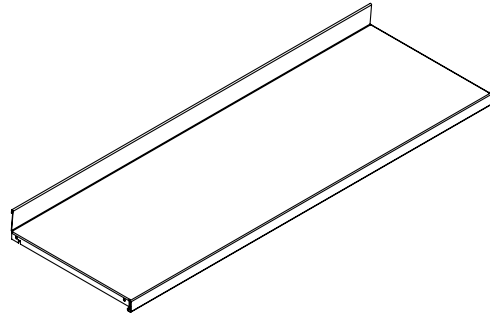

---

### B401013 - S2 STEEL SHELF WITH ACRYLIC BACKEDGE - FOR HANGING BOOK SUPPORT

Details:

- Module 750/900/1000 mm
- Depth 225/250/300/400 mm
- Acrylic backedge H17 mm (loose part)
- Hanging book support
- Steel plate brackets
- Max. weight 80 kg.
- Straight, 45°/60° sloping & 7,5° reverse tilted
- Use with steel top shelf B401005

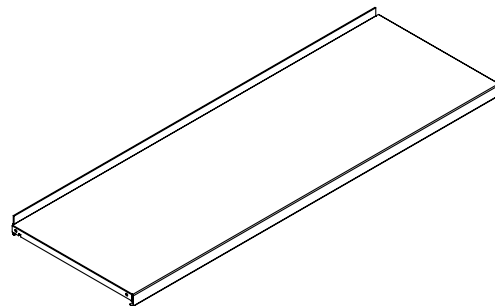

See below for overview of standard steel bottom shelves:

---

### B301410 - BOTTOM STEEL SHELF WITH PLINTH

Details:

- Module 750/900/1000 mm
- Depth 225/250/300/400 mm
- Steel backedge H47 mm
- Steel brackets
- Max. weight 80 kg.
- Use with steel shelf B401001, steel top shelf B401003, B401011, B301049, B301049, and wooden top shelf B401020

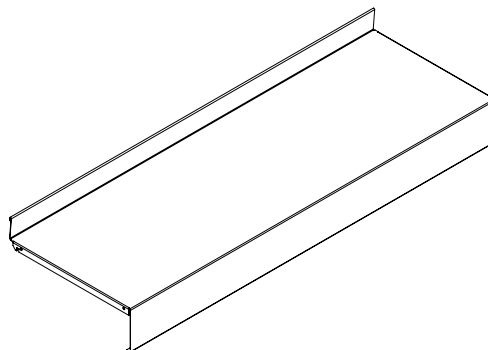

# SHELVES

## S1 STEEL SHELF WITH STEEL BACKEDGE

### S1 steel shelf with steel backedge and steel brackets - for backedge book support

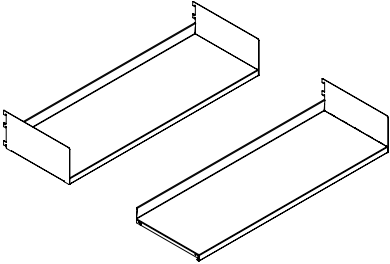
Steel backedge H47 mm. Incl. H15 cm brackets. Shelves for starter bays include left and right brackets. Shelves for add-on bays include double bracket.	Module cm	Shelf depth cm	Item no. Starter bay	Price DKK	Item no. Add-on bay	Price DKK
	75	22.5	BB4007621117	567	BB4007622117	480
	75	25	BB4007621127	619	BB4007622127	511
	75	30	BB4007621137	652	BB4007622137	545
	75	40	BB4007621147	787	BB4007622147	659
	90	22.5	BB4007621119	607	BB4007622119	520
	90	25	BB4007621129	643	BB4007622129	535
	90	30	BB4007621139	688	BB4007622139	581
	90	40	BB4007621149	876	BB4007622149	748
	100	22.5	BB4007621111	647	BB4007622111	560
	100	25	BB4007621121	696	BB4007622121	588
	100	30	BB4007621131	734	BB4007622131	627
	100	40	BB4007621141	898	BB4007622141	770

### S1 steel shelf with steel frontedge and 45°/60° steel plate brackets

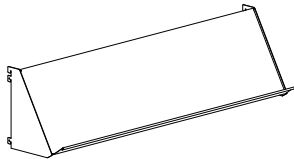
Steel backedge H47 mm. Incl. left and right brackets.	Module cm	Shelf depth cm	Item no. 45°	Price DKK	Item no. 60°	Price DKK
	75	22.5	BB301201745	935	BB301201760	935
	75	25	BB301202745	963	BB301202760	963
	75	30	BB301203745	988	BB301203760	988
	90	22.5	BB301201945	975	BB301201960	975
	90	25	BB301202945	987	BB301202960	987
	90	30	BB301203945	1.024	BB301203960	1.024
	100	22.5	BB301201145	1.015	BB301201160	1.015
	100	25	BB301202145	1.040	BB301202160	1.040
	100	30	BB301203145	1.070	BB301203160	1.070

### S1 steel shelf with steel backedge and 7.5° reverse tilted steel plate brackets

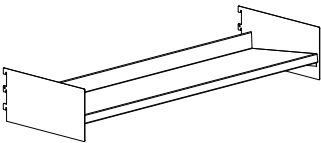
Steel backedge H47 mm. Incl. left and right brackets.	Module cm	Shelf depth cm	Dimension W X H cm	Item no.	Price DKK
	75	22.5	25 x 15	BB30122174	823
	75	22.5	30 x 15	BB30122171	823
	75	25	30 x 15	BB30122275	851
	75	30	35 x 20	BB30122372	988
	75	30	40 x 15	BB30122376	988
	75	30	40 x 20	BB30122373	988
	90	22.5	25 x 15	BB30122194	863
	90	22.5	30 x 15	BB30122191	863
	90	25	30 x 15	BB30122295	875
	90	30	35 x 20	BB30122392	1.024
	90	30	40 x 15	BB30122396	1.024
	90	30	40 x 20	BB30122393	1.024
	100	22.5	25 x 15	BB30122114	903
	100	22.5	30 x 15	BB30122111	903
	100	25	30 x 15	BB30122215	928
	100	30	35 x 20	BB30122312	1.070
	100	30	40 x 15	BB30122316	1.070
	100	30	40 x 20	BB30122313	1.070

# SHELVES

## S1 STEEL SHELF WITH STEEL BACKEDGE

### S1 steel shelf with steel backedge - for backedge book support

Steel backedge H47 mm. Left, right or double brackets must be ordered separately. See page 72.

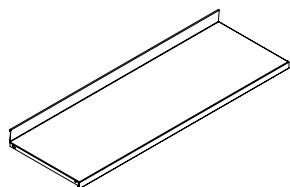

Module cm	Shelf depth cm	Item no.	Price DKK
75	22.5	B40100117	369
75	25	B40100127	397
75	30	B40100137	422
75	40	B40100147	507
90	22.5	B40100119	409
90	25	B40100129	421
90	30	B40100139	458
90	40	B40100149	596
100	22.5	B40100111	449
100	25	B40100121	474
100	30	B40100131	504
100	40	B40100141	618

### Backedge book support - for S1 steel shelf

Nickel plated steel, Ø6 mm, with a nylon glider.

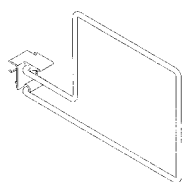

Height cm	Shelf depth cm	Type	Item no.	Price DKK
16,3	22.5/25	For books on left side of book support	B4011221	127
16,3	30	For books on left side of book support	B4011222	137
24,3	25/30	For books on left side of book support	B4011223	178
16,3	22.5/25	For books on right side of book support	B4011224	127
16,3	30	For books on right side of book support	B4011225	137

# SHELVES

## S2 STEEL SHELF WITH ACRYLIC BACKEDGE

### S2 steel shelf with acrylic backedge and steel brackets - for hanging book support

Acrylic backedge H17 mm. Shelves for starter bays include left and right brackets. Shelves for add-on bays include double bracket. Note: Spot welding visible on top of surface.

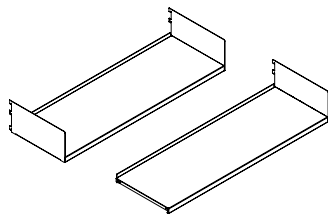

Module cm	Shelf depth cm	Item no. Starter bay	Price DKK	Item no. Add-on bay	Price DKK
75	22.5	BB4007721117	489	BB4007722117	402
75	25	BB4007721127	513	BB4007722127	405
75	30	BB4007721137	556	BB4007722137	449
75	40	BB4007721147	826	BB4007722147	698
90	22.5	BB4007721119	489	BB4007722119	402
90	25	BB4007721129	513	BB4007722129	405
90	30	BB4007721139	556	BB4007722139	449
90	40	BB4007721149	826	BB4007722149	698
100	22.5	BB4007721111	521	BB4007722111	434
100	25	BB4007721121	545	BB4007722121	437
100	30	BB4007721131	598	BB4007722131	491
100	40	BB4007721141	892	BB4007722141	764

### S2 steel shelf with acrylic backedge and 45°/60° steel plate brackets

Acrylic backedge H17 mm. Incl. left and right brackets. Note: Spot welding visible on top of surface.

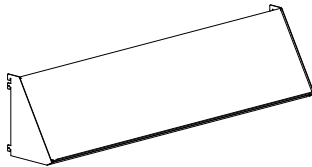

Module cm	Shelf depth cm	Item no. 45°	Price DKK	Item no. 60°	Price DKK
75	22.5	BB301241745	857	BB301241760	857
75	25	BB301242745	857	BB301242760	857
75	30	BB301243745	892	BB301243760	892
90	22.5	BB301241945	857	BB301241960	857
90	25	BB301242945	857	BB301242960	857
90	30	BB301243945	892	BB301243960	892
100	22.5	BB301241145	889	BB301241160	889
100	25	BB301242145	889	BB301242160	889
100	30	BB301243145	934	BB301243160	934

### S2 steel shelf with acrylic backedge and 7.5° reverse tilted steel plate brackets

Acrylic backedge H17 mm. Incl. left and right brackets. Note: Spot welding visible on top of surface.

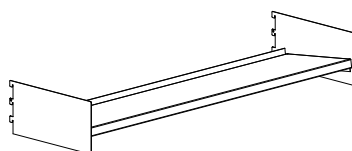

Module cm	Shelf depth cm	Dimension W X H cm	Item no.	Price DKK
75	22.5	25 x 15	BB30126174	745
75	22.5	30 x 15	BB30126171	745
75	25	30 x 15	BB30126275	745
75	30	35 x 20	BB30126372	892
75	30	40 x 15	BB30126376	892
75	30	40 x 20	BB30126373	892
90	22.5	25 x 15	BB30126194	745
90	22.5	30 x 15	BB30126191	745
90	25	30 x 15	BB30126295	745
90	30	35 x 20	BB30126392	892
90	30	40 x 15	BB30126396	892
90	30	40 x 20	BB30126393	892
100	22.5	25 x 15	BB30126114	777
100	22.5	30 x 15	BB30126111	777
100	25	30 x 15	BB30126215	777
100	30	35 x 20	BB30126312	934
100	30	40 x 15	BB30126316	934
100	30	40 x 20	BB30126313	934

# SHELVES

## S2 STEEL SHELF WITH ACRYLIC BACKEDGE

### S2 steel shelf with acrylic backedge - for hanging book support

Acrylic backedge 17 mm. Left, right or double brackets must be ordered separately. See page 72. Note: Spot welding visible on top of surface.

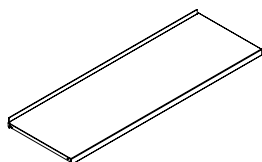

Module cm	Shelf depth cm	Item no.	Price DKK
75	22.5	B40101317	291
75	25	B40101327	291
75	30	B40101337	326
75	40	B40101347	546
90	22.5	B40101319	291
90	25	B40101329	291
90	30	B40101339	326
90	40	B40101349	546
100	22.5	B40101311	323
100	25	B40101321	323
100	30	B40101331	368
100	40	B40101341	612

### Hanging book support - for S2

Available in chromed steel or standard steel colours.



Height cm	Item no.	Price DKK
20	B4011242	68
25	B4011245	73

# SHELVES

## BRACKETS FOR S1 & S2

### Steel plate bracket for S1 & S2

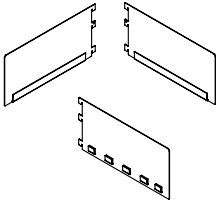

Type	Shelf depth cm	Item no. H15 cm	Price DKK	Item no. H20 cm	Price DKK
Left	22,5	B30101417	99	B30102017	140
Left	25	B30101427	111	B30102027	152
Left	30	B30101437	115	B30102037	163
Left	40	B30101447	140	B30102047	187
Right	22,5	B30101418	99	B30102018	140
Right	25	B30101428	111	B30102028	152
Right	30	B30101438	115	B30102038	163
Right	40	B30101448	140	B30102048	187
Double	22,5	B30101419	111		
Double	25	B30101429	114		
Double	30	B30101439	123		
Double	40	B30101449	152		

### 45°/60° steel plate bracket - for S1 & S2

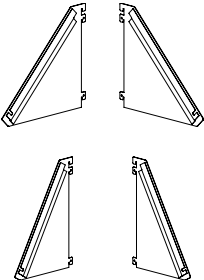

Depth cm	Degree	Item no. Left	Price DKK	Item no. Right	Price DKK
22.5	45°	B3010321458	283	B3010321459	283
25	45°	B3010322458	283	B3010322459	283
30	45°	B3010323458	283	B3010323459	283
22.5	60°	B3010321608	283	B3010321609	283
25	60°	B3010322608	283	B3010322609	283
30	60°	B3010323608	283	B3010323609	283

### 7.5° reverse tilted steel plate bracket - for S1 & S2

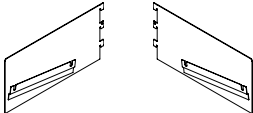

Shelf depth cm	Dimension W X H cm	Item no. Left	Price DKK	Item no. Right	Price DKK
22.5	25 x 15	B30114048	227	B30114049	227
22.5	30 x 15	B30114018	227	B30114019	227
25	30 x 15	B30114058	227	B30114059	227
30	35 x 20	B30114028	283	B30114029	283
30	40 x 15	B30114068	283	B30114069	283
30	40 x 20	B30114038	283	B30114039	283

### Steel brackets for various shelf depths - for S1 & S2

Brackets for shelves with shorter depth than actual shelving system. This places the shelf in line with the front of shelving system.

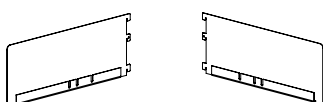

Depth cm	For shelving depths cm	Item no. Left	Price DKK	Item no. Right	Price DKK
25	22.5	B30102628	146	B30102629	146
30	22.5, 25	B30102638	155	B30102639	155
40	22.5, 25, 30	B30102648	183	B30102649	183



# SHELVES

## STEEL BOTTOM SHELF WITH BACKEDGE AND INTEGRATED PLINTH

### Steel bottom shelf with steel backedge and integrated plinth - for backedge book support

Steel backedge H47 mm, integrated plinth H92 mm. Brackets must be ordered separately. See below. Does not fit Classic Steel 80/30.

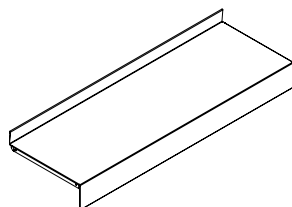

Module cm	Shelf depth cm	Item no.	Price DKK
75	22.5	B30141017	407
75	25	B30141027	435
75	30	B30141037	460
75	40	B30141047	562
90	22.5	B30141019	451
90	25	B30141029	458
90	30	B30141039	504
90	40	B30141049	653
100	22.5	B30141011	492
100	25	B30141021	519
100	30	B30141031	557
100	40	B30141041	681

### Steel plate brackets for steel bottom shelf with steel backedge and integrated plinth

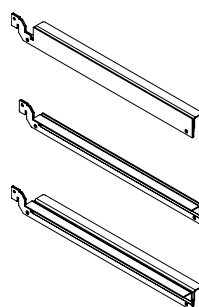

Type	Shelf depth cm	Item no.	Price DKK
Left	22.5	B30141417	281
Left	25	B30141427	323
Left	30	B30141437	346
Left	40	B30141447	415
Right	22.5	B30141418	281
Right	25	B30141428	323
Right	30	B30141438	346
Right	40	B30141448	415
Double	22.5	B30141419	323
Double	25	B30141429	339
Double	30	B30141439	359
Double	40	B30141449	447

# SHELVES

## SINGLE-SIDED STEEL TOP SHELVES

See below for overview of standard steel top shelves:

---

### B401003 - SINGLE-SIDED STEEL TOP SHELF - 25 MM FRONTEDGE

Details:

- Module 750/900/1000 mm
- Depth 225/250/300/400 mm
- Steel brackets
- Max. weight 25 kg.
- Use with steel shelves with steel backedge for backedge book support

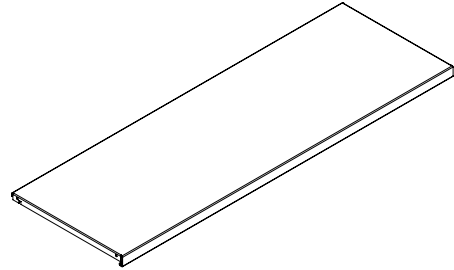

---

### B401005 - SINGLE-SIDED STEEL TOP SHELF - SIGN PROFILE

Details:

- Module 750/900/1000 mm
- Depth 225/250/300/400 mm
- Steel brackets
- Max. weight 25 kg.
- Use with steel shelves with steel backedge for backedge book support

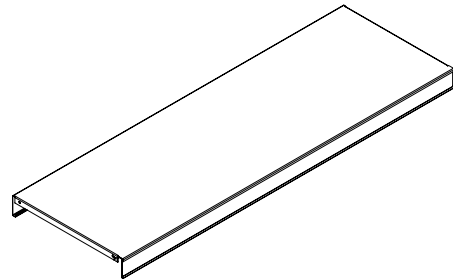

---

### B401011 - SINGLE-SIDED STEEL TOP SHELF - 25 MM FRONTEDGE

Details:

- Module 750/900/1000 mm
- Depth 250/300/400 mm
- Steel brackets
- Max. weight 25 kg.
- Use with steel shelves with acrylic backedge for hanging book support

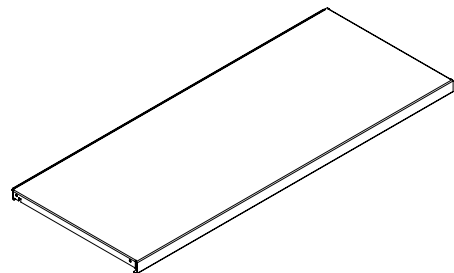

# SHELVES

## SINGLE- & DOUBLE-SIDED STEEL TOP SHELVES & LONDON TOP PLATE

See below for overview of standard steel top shelves:

---

### B301049 - SINGLE-SIDED STEEL TOP SHELF - 25/47 MM FRONTEDGE

Details:

- Module 750/900/1000 mm
- Depth 225/250/300/400 mm
- Steel brackets
- Max. weight 25 kg.
- 1/2 bays
- Use with steel shelves with steel backedge for backedge book support

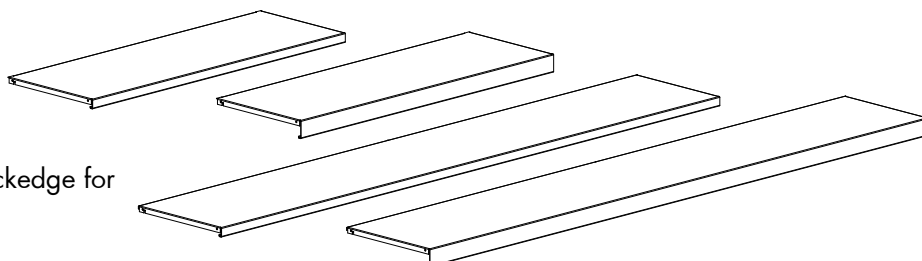

### B301046 - DOUBLE-SIDED STEEL TOP SHELF - 25/47 MM FRONTEDGE

Details:

- Module 750/900/1000 mm
- Depth 225/250/300/400 mm
- Freestanding/outer/intermediate
- Steel brackets
- Max. weight 25 kg.
- 1/2 bays
- Use with steel shelves with steel backedge for backedge book support

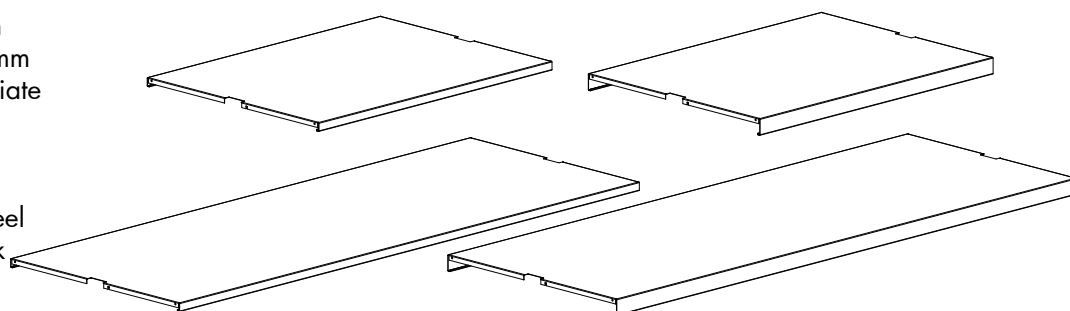

### B301628 - SINGLE-SIDED LONDON STEEL TOP PLATE - 30 MM FRONTEDGE

Details:

- Module 750/900/1000 mm
- Depth 225/250/300/400 mm
- Freestanding/outer/intermediate
- Steel brackets
- Max. weight 25 kg.
- 1/2 bays

### B301628 - DOUBLE-SIDED LONDON STEEL TOP PLATE - 30 MM FRONTEDGE

Details:

- Module 750/900/1000 mm
- Depth 225/250/300/400 mm
- Freestanding/outer/intermediate
- Steel brackets
- Max. weight 25 kg.
- 1/2 bays

# SHELVES

## SINGLE-SIDED STEEL TOP SHELVES - 25 MM FRONTEDGE - FOR BACKEDGE BOOK SUPPORT

### Steel top shelf with brackets - to be used with steel shelves for backedge book support

Incl. H7.5 cm brackets. Top shelves for starter bays include left and right brackets. Top shelves for add-on bays include double bracket.

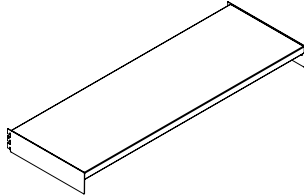

Module cm	Shelf depth cm	Item no. Starter bay	Price DKK	Item no. Add-on bay	Price DKK
75	22.5	BB4007621217	623	BB4007622217	516
75	25	BB4007621227	633	BB4007622227	526
75	30	BB4007621237	698	BB4007622237	591
75	40	BB4007621247	792	BB4007622247	675
90	22.5	BB4007621219	637	BB4007622219	530
90	25	BB4007621229	680	BB4007622229	573
90	30	BB4007621239	721	BB4007622239	614
90	40	BB4007621249	866	BB4007622249	749
100	22.5	BB4007621211	703	BB4007622211	596
100	25	BB4007621221	735	BB4007622221	628
100	30	BB4007621231	767	BB4007622231	660
100	40	BB4007621241	899	BB4007622241	782

### Steel top shelf without brackets - to be used with steel shelves for backedge book support

Brackets must be ordered separately. A top shelf for starter bays must have a left and a right bracket. Top shelves for add-on bays must have a double bracket. See below.

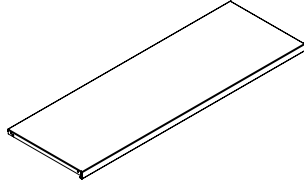

Module cm	Shelf depth cm	Item no.	Price DKK
75	22.5	B40100317	401
75	25	B40100327	405
75	30	B40100337	468
75	40	B40100347	538
90	22.5	B40100319	415
90	25	B40100329	452
90	30	B40100339	491
90	40	B40100349	612
100	22.5	B40100311	481
100	25	B40100321	507
100	30	B40100331	537
100	40	B40100341	645

### Steel bracket for steel top shelf

H7.5 cm. Max. load of 25 kg.

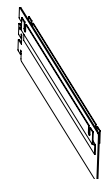
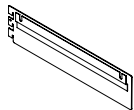
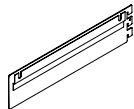

Type	Shelf depth cm	Item no.	Price DKK
Left	22.5	B30102417	111
Left	25	B30102427	114
Left	30	B30102437	115
Left	40	B30102447	127
Right	22.5	B30102418	111
Right	25	B30102428	114
Right	30	B30102438	115
Right	40	B30102448	127
Double	22.5	B30102419	115
Double	25	B30102429	121
Double	30	B30102439	123
Double	40	B30102449	137

# SHELVES

## SINGLE-SIDED STEEL TOP SHELVES - SIGN PROFILE - FOR BACKEDGE BOOK SUPPORT

### Steel top shelf with sign profile and brackets - to be used with steel shelves for backedge book support

Incl. brackets. Label B401130 to be ordered separately. Top shelves for starter bays include left and right brackets. Top shelves for add-on bays include double bracket.

Module cm	Shelf depth cm	Item no. Starter bay	Price DKK	Item no. Add-on bay	Price DKK
75	22.5	BB400752117	870	BB400752217	763
75	25	BB400752127	900	BB400752227	793
75	30	BB400752137	936	BB400752237	829
75	40	BB400752147	1.026	BB400752247	909
90	22.5	BB400752119	905	BB400752219	798
90	25	BB400752129	936	BB400752229	829
90	30	BB400752139	960	BB400752239	853
90	40	BB400752149	1.098	BB400752249	981
100	22.5	BB400752111	973	BB400752211	866
100	25	BB400752121	987	BB400752221	880
100	30	BB400752131	1.026	BB400752231	919
100	40	BB400752141	1.145	BB400752241	1.028

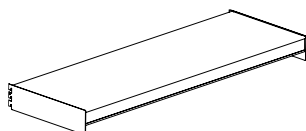

### Steel top shelf with sign profile without brackets - to be used with steel shelves for backedge book support

Brackets and label B401130 must be ordered separately. A top shelf for starter bays must have a left and a right bracket. Top shelves for add-on bays must have a double bracket. See below.

Module cm	Shelf depth cm	Item no.	Price DKK
75	22.5	B40100517	648
75	25	B40100527	672
75	30	B40100537	706
75	40	B40100547	772
90	22.5	B40100519	683
90	25	B40100529	708
90	30	B40100539	730
90	40	B40100549	844
100	22.5	B40100511	751
100	25	B40100521	759
100	30	B40100531	796
100	40	B40100541	891

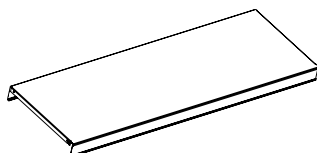

### Steel bracket for steel top shelf

H7.5 cm. Max. load of 25 kg.

Type	Shelf depth cm	Item no.	Price DKK
Left	22.5	B30102417	111
Left	25	B30102427	114
Left	30	B30102437	115
Left	40	B30102447	127
Right	22.5	B30102418	111
Right	25	B30102428	114
Right	30	B30102438	115
Right	40	B30102448	127
Double	22.5	B30102419	115
Double	25	B30102429	121
Double	30	B30102439	123
Double	40	B30102449	137

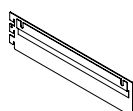
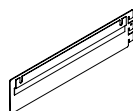

# SHELVES

## SINGLE-SIDED STEEL TOP SHELVES - 25 MM FRONTEDGE - FOR HANGING BOOK SUPPORT

### Steel top shelf with brackets - to be used with shelves for hanging book support

Incl. H7.5 cm lower brackets. Top shelves for starter bays include left and right brackets. Top shelves for add-on bays include double bracket.

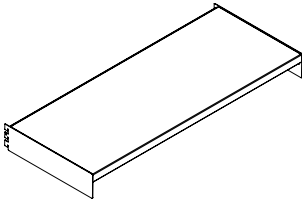

Module cm	Shelf depth cm	Item no. Starter bay	Price DKK	Item no. Add-on bay	Price DKK
75	22.5	BB4007721217	479	BB4007722217	372
75	25	BB4007721227	485	BB4007722227	378
75	30	BB4007721237	521	BB4007722237	414
75	40	BB4007721247	800	BB4007722247	683
90	22.5	BB4007721219	479	BB4007722219	372
90	25	BB4007721229	485	BB4007722229	378
90	30	BB4007721239	521	BB4007722239	414
90	40	BB4007721249	800	BB4007722249	683
100	22.5	BB4007721211	543	BB4007722211	436
100	25	BB4007721221	549	BB4007722221	442
100	30	BB4007721231	553	BB4007722231	446
1000	40	BB4007721241	866	BB4007722241	749

### Steel top shelf without brackets - to be used with shelves for hanging book support

Brackets must be ordered separately. A top shelf for starter bays must have a left and a right bracket. Top shelves for add-on bays must have a double bracket. See below.

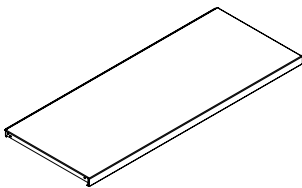

Module cm	Shelf depth cm	Item no.	Price DKK
75	22.5	B40101117	257
75	25	B40101127	257
75	30	B40101137	291
75	40	B40101147	546
90	22.5	B40101119	257
90	25	B40101129	257
90	30	B40101139	291
90	40	B40101149	546
100	22.5	B40101111	321
100	25	B40101121	321
100	30	B40101131	323
100	40	B40101141	612

### Steel bracket for steel top shelf

H7.5 cm. Max. load of 25 kg.

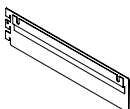
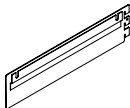

Type	Shelf depth cm	Item no.	Price DKK
Left	22.5	B30102417	111
Left	25	B30102427	114
Left	30	B30102437	115
Left	40	B30102447	127
Right	22.5	B30102418	111
Right	25	B30102428	114
Right	30	B30102438	115
Right	40	B30102448	127
Double	22.5	B30102419	115
Double	25	B30102429	121
Double	30	B30102439	123
Double	40	B30102449	137



# SHELVES

## SINGLE-SIDED STEEL TOP SHELF - 25 MM FRONTEDGE - WITH BRACKETS

Single-sided steel top shelf with brackets - to be used with steel shelves for backedge book support - for 1 bay

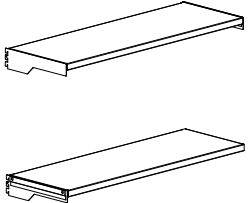
Incl. brackets. Top shelves for starter bays include left and right brackets. Top shelves for add-on bays include double bracket.	Module cm	Shelf depth cm	Item no. Starter bay	Price DKK	Item no. Add-on bay	Price DKK
	75	22.5	BB30117171125	870	BB30117271125	763
	75	25	BB30117172125	900	BB30117272125	793
	75	30	BB30117173125	936	BB30117273125	829
	75	40	BB30117174125	1.026	BB30117274125	909
	90	22.5	BB30117191125	905	BB30117291125	798
	90	25	BB30117192125	936	BB30117292125	829
	90	30	BB30117193125	960	BB30117293125	853
	90	40	BB30117194125	1.098	BB30117294125	981
	100	22.5	BB30117111125	973	BB30117211125	866
	100	25	BB30117112125	987	BB30117212125	880
	100	30	BB30117113125	1.026	BB30117213125	919
	100	40	BB30117114125	1.145	BB30117214125	1.028

Single-sided steel top shelf with brackets - to be used with steel shelves for backedge book support - for 2 bays

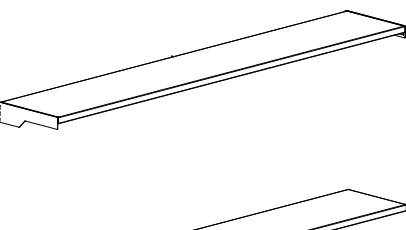
Incl. brackets. Top shelves for starter bays include left, middle and right brackets. Top shelves for add-on bays include middle and double bracket.	Module cm	Shelf depth cm	Item no. Starter bay	Price DKK	Item no. Add-on bay	Price DKK
	75	22.5	BB30117171225	1.362	BB30117271225	1.255
	75	25	BB30117172225	1.412	BB30117272225	1.305
	75	30	BB30117173225	1.473	BB30117273225	1.366
	75	40	BB30117174225	1.612	BB30117274225	1.495
	90	22.5	BB30117191225	1.423	BB30117291225	1.316
	90	25	BB30117192225	1.474	BB30117292225	1.367
	90	30	BB30117193225	1.514	BB30117293225	1.407
	90	40	BB30117194225	1.738	BB30117294225	1.621
	100	22.5	BB30117111225	1.544	BB30117211225	1.437
	100	25	BB30117112225	1.563	BB30117212225	1.456
	100	30	BB30117113225	1.632	BB30117213225	1.525
	100	40	BB30117114225	1.821	BB30117214225	1.704



# SHELVES

## SINGLE-SIDED STEEL TOP SHELF - 25 MM FRONTEDGE

Single-sided steel top shelf without brackets - to be used with steel shelves for backedge book support - for 1 bay

Brackets must be ordered separately. A top shelf for starter bays must have a left and a right bracket. Top shelves for add-on bays must have a double bracket. See page 96.



Module cm	Shelf depth cm	Item no.	Price DKK
75	22.5	B30104971125	648
75	25	B30104972125	672
75	30	B30104973125	706
75	40	B30104974125	772
90	22.5	B30104991125	683
90	25	B30104992125	708
90	30	B30104993125	730
90	40	B30104994125	844
100	22.5	B30104911125	751
100	25	B30104912125	759
100	30	B30104913125	796
100	40	B30104914125	891

Single-sided steel top shelf without brackets - to be used with steel shelves for backedge book support - for 2 bays

Brackets must be ordered separately. A top shelf for starter bays must have a left, a middle and a right bracket. Top shelves for add-on bays must have a middle and a double bracket. See page 96.

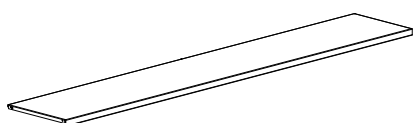

Module cm	Shelf depth cm	Item no.	Price DKK
75	22.5	B30104971225	1.140
75	25	B30104972225	1.184
75	30	B30104973225	1.243
75	40	B30104974225	1.358
90	22.5	B30104991225	1.201
90	25	B30104992225	1.246
90	30	B30104993225	1.284
90	40	B30104994225	1.484
100	22.5	B30104911225	1.322
100	25	B30104912225	1.335
100	30	B30104913225	1.402
100	40	B30104914225	1.567

# SHELVES

## SINGLE-SIDED STEEL TOP SHELF - 47 MM FRONTEDGE - WITH BRACKETS

Single-sided steel top shelf with brackets - to be used with steel shelves for backedge book support - for 1 bay

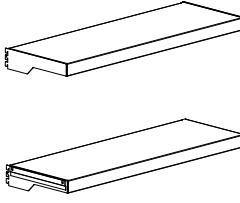
Incl. brackets. Top shelves for starter bays include left and right brackets. Top shelves for add-on bays include double bracket.	Module cm	Shelf depth cm	Item no. Starter bay	Price DKK	Item no. Add-on bay	Price DKK
	75	22.5	BB30117171147	870	BB30117271147	763
	75	25	BB30117172147	900	BB30117272147	793
	75	30	BB30117173147	936	BB30117273147	829
	75	40	BB30117174147	1.026	BB30117274147	909
	90	22.5	BB30117191147	905	BB30117291147	798
	90	25	BB30117192147	936	BB30117292147	829
	90	30	BB30117193147	960	BB30117293147	853
	90	40	BB30117194147	1.098	BB30117294147	981
	100	22.5	BB30117111147	973	BB30117211147	866
	100	25	BB30117112147	987	BB30117212147	880
	100	30	BB30117113147	1.026	BB30117213147	919
	100	40	BB30117114147	1.145	BB30117214147	1.028

Single-sided steel top shelf with brackets - to be used with steel shelves for backedge book support - for 2 bays

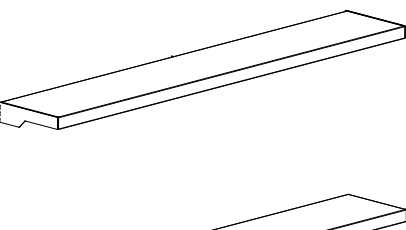
Incl. brackets. Top shelves for starter bays include left, middle and right brackets. Top shelves for add-on bays include middle and double bracket.	Module cm	Shelf depth cm	Item no. Starter bay	Price DKK	Item no. Add-on bay	Price DKK
	75	22.5	BB30117171247	1.362	BB30117271247	1.255
	75	25	BB30117172247	1.412	BB30117272247	1.305
	75	30	BB30117173247	1.473	BB30117273247	1.366
	75	40	BB30117174247	1.612	BB30117274247	1.495
	90	22.5	BB30117191247	1.423	BB30117291247	1.316
	90	25	BB30117192247	1.474	BB30117292247	1.367
	90	30	BB30117193247	1.514	BB30117293247	1.407
	90	40	BB30117194247	1.738	BB30117294247	1.621
	100	22.5	BB30117111247	1.544	BB30117211247	1.437
	100	25	BB30117112247	1.563	BB30117212247	1.456
	100	30	BB30117113247	1.632	BB30117213247	1.525
	100	40	BB30117114247	1.821	BB30117214247	1.704

# SHELVES

## SINGLE-SIDED STEEL TOP SHELF - 47 MM FRONTEDGE

Single-sided steel top shelf without brackets - to be used with steel shelves for backedge book support - for 1 bay

Brackets must be ordered separately. A top shelf for starter bays must have a left and a right bracket. Top shelves for add-on bays must have a double bracket. See page 96.



Module cm	Shelf depth cm	Item no.	Price DKK
75	22.5	B30104971147	648
75	25	B30104972147	672
75	30	B30104973147	706
75	40	B30104974147	772
90	22.5	B30104991147	683
90	25	B30104992147	708
90	30	B30104993147	730
90	40	B30104994147	844
100	22.5	B30104911147	751
100	25	B30104912147	759
100	30	B30104913147	796
100	40	B30104914147	891

Single-sided steel top shelf without brackets - to be used with steel shelves for backedge book support - for 2 bays

Brackets must be ordered separately. A top shelf for starter bays must have a left, a middle and a right bracket. Top shelves for add-on bays must have a middle and a double bracket. See page 96.

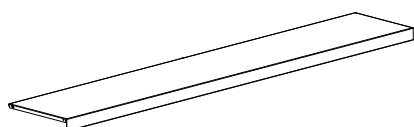

Module cm	Shelf depth cm	Item no.	Price DKK
75	22.5	B30104971247	1.140
75	25	B30104972247	1.184
75	30	B30104973247	1.243
75	40	B30104974247	1.358
90	22.5	B30104991247	1.201
90	25	B30104992247	1.246
90	30	B30104993247	1.284
90	40	B30104994247	1.484
100	22.5	B30104911247	1.322
100	25	B30104912247	1.335
100	30	B30104913247	1.402
100	40	B30104914247	1.567

# SHELVES

## DOUBLE-SIDED STEEL TOP SHELVES - 25 MM FRONTEGE - FREESTANDING - WITH BRACKETS

### Double-sided steel top shelf with brackets - for 1 freestanding bay

2 left and 2 right brackets included.

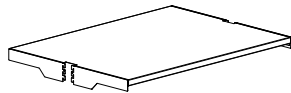

No. of bays	Frontedge cm	Module cm	Shelf depth cm	Item no.	Price DKK
1	25	75	22.5	BB30115719125	1.740
1	25	75	25	BB30115729125	1.801
1	25	75	30	BB30115739125	1.872
1	25	75	40	BB30115749125	2.052
1	25	90	22.5	BB30115919125	1.809
1	25	90	25	BB30115929125	1.873
1	25	90	30	BB30115939125	1.920
1	25	90	40	BB30115949125	2.195
1	25	100	22.5	BB30115119125	1.947
1	25	100	25	BB30115129125	1.973
1	25	100	30	BB30115139125	2.053
1	25	100	40	BB30115149125	2.289

### Double-sided steel top shelf with brackets - for 2 freestanding bays

2 left, 2 middle and 2 right brackets included.

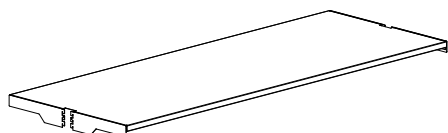

No. of bays	Frontedge cm	Module cm	Shelf depth cm	Item no.	Price DKK
2	25	75	22.5	BB30115719225	2.725
2	25	75	25	BB30115729225	2.823
2	25	75	30	BB30115739225	2.946
2	25	75	40	BB30115749225	3.225
2	25	90	22.5	BB30115919225	2.847
2	25	90	25	BB30115929225	2.949
2	25	90	30	BB30115939225	3.029
2	25	90	40	BB30115949225	3.477
2	25	100	22.5	BB30115119225	3.089
2	25	100	25	BB30115129225	3.126
2	25	100	30	BB30115139225	3.263
2	25	100	40	BB30115149225	3.643

# SHELVES

## DOUBLE-SIDED STEEL TOP SHELVES - 25 MM FRONTEDGE - FREESTANDING

### Double-sided steel top shelf without brackets - for 1 freestanding bay

2 left and 2 right brackets must be ordered separately. See page 96.

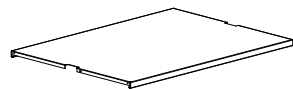

No. of bays	Frontedge cm	Module cm	Shelf depth cm	Item no.	Price DKK
1	25	75	22.5	B301046719125	1.296
1	25	75	25	B301046729125	1.345
1	25	75	30	B301046739125	1.412
1	25	75	40	B301046749125	1.544
1	25	90	22.5	B301046919125	1.365
1	25	90	25	B301046929125	1.417
1	25	90	30	B301046939125	1.460
1	25	90	40	B301046949125	1.687
1	25	100	22.5	B301046119125	1.503
1	25	100	25	B301046129125	1.517
1	25	100	30	B301046139125	1.593
1	25	100	40	B301046149125	1.781

### Double-sided steel top shelf without brackets - for 2 freestanding bays

2 left, 2 middle and 2 right brackets must be ordered separately. See page 96.

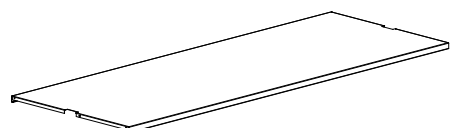

No. of bays	Frontedge cm	Module cm	Shelf depth cm	Item no.	Price DKK
2	25	75	22.5	B301046719225	2.281
2	25	75	25	B301046729225	2.367
2	25	75	30	B301046739225	2.486
2	25	75	40	B301046749225	2.717
2	25	90	22.5	B301046919225	2.403
2	25	90	25	B301046929225	2.493
2	25	90	30	B301046939225	2.569
2	25	90	40	B301046949225	2.969
2	25	100	22.5	B301046119225	2.645
2	25	100	25	B301046129225	2.670
2	25	100	30	B301046139225	2.803
2	25	100	40	B301046149225	3.135

# SHELVES

## DOUBLE-SIDED STEEL TOP SHELVES - 25 MM FRONTEDGE - OUTER - WITH BRACKETS

### Double-sided steel top shelf with brackets - for 1 outer bay

1 left, 1 right and 1 double bracket included.

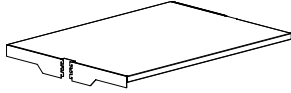

No. of bays	Frontedge cm	Module cm	Shelf depth cm	Item no.	Price DKK
1	25	75	22.5	BB30115718125	1.633
1	25	75	25	BB30115728125	1.694
1	25	75	30	BB30115738125	1.765
1	25	75	40	BB30115748125	1.935
1	25	90	22.5	BB30115918125	1.702
1	25	90	25	BB30115928125	1.766
1	25	90	30	BB30115938125	1.813
1	25	90	40	BB30115948125	2.078
1	25	100	22.5	BB30115118125	1.840
1	25	100	25	BB30115128125	1.866
1	25	100	30	BB30115138125	1.946
1	25	100	40	BB30115148125	2.172

### Double-sided steel top shelf with brackets - for 2 outer bays

1 left, 1 right, 1 double and 2 middle brackets included.

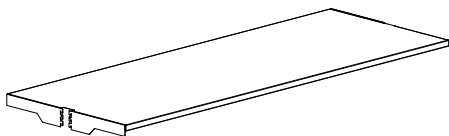

No. of bays	Frontedge cm	Module cm	Shelf depth cm	Item no.	Price DKK
2	25	75	22.5	BB30115718225	2.618
2	25	75	25	BB30115728225	2.716
2	25	75	30	BB30115738225	2.839
2	25	75	40	BB30115748225	3.108
2	25	90	22.5	BB30115918225	2.740
2	25	90	25	BB30115928225	2.842
2	25	90	30	BB30115938225	2.922
2	25	90	40	BB30115948225	3.360
2	25	100	22.5	BB30115118225	2.982
2	25	100	25	BB30115128225	3.019
2	25	100	30	BB30115138225	3.156
2	25	100	40	BB30115148225	3.526

# SHELVES

## DOUBLE-SIDED STEEL TOP SHELVES - 25 MM FRONTEDGE - OUTER

### Double-sided steel top shelf without brackets - for 1 outer bay

1 left, 1 right and 1 double bracket must be ordered separately. See page 96.

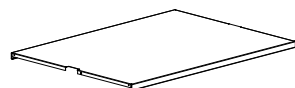

No. of bays	Frontedge cm	Module cm	Shelf depth cm	Item no.	Price DKK
1	25	75	22.5	B301046718125	1.296
1	25	75	25	B301046728125	1.345
1	25	75	30	B301046738125	1.412
1	25	75	40	B301046748125	1.544
1	25	90	22.5	B301046718147	1.296
1	25	90	25	B301046728147	1.345
1	25	90	30	B301046738147	1.412
1	25	90	40	B301046748147	1.544
1	25	100	22.5	B301046918125	1.365
1	25	100	25	B301046928125	1.417
1	25	100	30	B301046938125	1.460
1	25	100	40	B301046948125	1.687

### Double-sided steel top shelf without brackets - for 2 outer bays

1 left, 1 right, 1 double and 2 middle brackets must be ordered separately. See page 96.

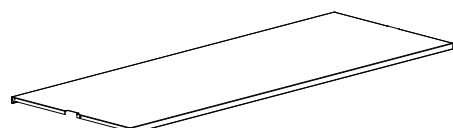

No. of bays	Frontedge cm	Module cm	Shelf depth cm	Item no.	Price DKK
2	25	75	22.5	B301046718225	2.281
2	25	75	25	B301046728225	2.367
2	25	75	30	B301046738225	2.486
2	25	75	40	B301046748225	2.717
2	25	90	22.5	B301046718247	2.281
2	25	90	25	B301046728247	2.367
2	25	90	30	B301046738247	2.486
2	25	90	40	B301046748247	2.717
2	25	100	22.5	B301046918225	2.403
2	25	100	25	B301046928225	2.493
2	25	100	30	B301046938225	2.569
2	25	100	40	B301046948225	2.969

# SHELVES

## DOUBLE-SIDED STEEL TOP SHELVES - 25 MM FRONTEDGE - INTERMEDIATE - WITH BRACKETS

### Double-sided steel top shelf with brackets - for 1 intermediate bay

2 double brackets included.

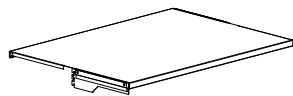

No. of bays	Frontedge cm	Module cm	Shelf depth cm	Item no.	Price DKK
1	25	75	22.5	BB30115717125	1.526
1	25	75	25	BB30115727125	1.587
1	25	75	30	BB30115737125	1.658
1	25	75	40	BB30115747125	1.818
1	25	90	22.5	BB30115917125	1.595
1	25	90	25	BB30115927125	1.659
1	25	90	30	BB30115937125	1.706
1	25	90	40	BB30115947125	1.961
1	25	100	22.5	BB30115117125	1.733
1	25	100	25	BB30115127125	1.759
1	25	100	30	BB30115137125	1.839
1	25	100	40	BB30115147125	2.055

### Double-sided steel top shelf with brackets - for 2 intermediate bays

2 double and 2 middle brackets included.

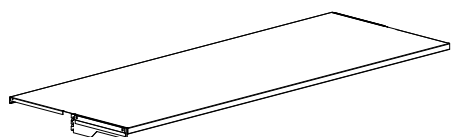

No. of bays	Frontedge cm	Module cm	Shelf depth cm	Item no.	Price DKK
2	25	75	22.5	BB30115717225	2.511
2	25	75	25	BB30115727225	2.609
2	25	75	30	BB30115737225	2.732
2	25	75	40	BB30115747225	2.991
2	25	90	22.5	BB30115917225	2.633
2	25	90	25	BB30115927225	2.735
2	25	90	30	BB30115937225	2.815
2	25	90	40	BB30115947225	3.243
2	25	100	22.5	BB30115117225	2.875
2	25	100	25	BB30115127225	2.912
2	25	100	30	BB30115137225	3.049
2	25	100	40	BB30115147225	3.409



# SHELVES

## DOUBLE-SIDED STEEL TOP SHELVES - 25 MM FRONTEDGE - INTERMEDIATE

### Double-sided steel top shelf without brackets - for 1 intermediate bay

2 double brackets must be ordered separately. See page 96.

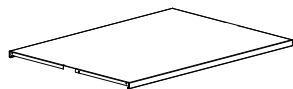

No. of bays	Frontedge cm	Module cm	Shelf depth cm	Item no.	Price DKK
1	25	75	22.5	B301046717125	1.296
1	25	75	25	B301046727125	1.345
1	25	75	30	B301046737125	1.412
1	25	75	40	B301046747125	1.544
1	25	90	22.5	B301046917125	1.365
1	25	90	25	B301046927125	1.417
1	25	90	30	B301046937125	1.460
1	25	90	40	B301046947125	1.687
1	25	100	22.5	B301046117125	1.503
1	25	100	25	B301046127125	1.517
1	25	100	30	B301046137125	1.593
1	25	100	40	B301046147125	1.781

### Double-sided steel top shelf without brackets - for 2 intermediate bays

2 double and 2 middle brackets must be ordered separately. See page 96.

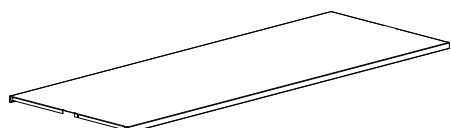

No. of bays	Frontedge cm	Module cm	Shelf depth cm	Item no.	Price DKK
2	25	75	22.5	B301046717225	2.281
2	25	75	25	B301046727225	2.367
2	25	75	30	B301046737225	2.486
2	25	75	40	B301046747225	2.717
2	25	90	22.5	B301046917225	2.403
2	25	90	25	B301046927225	2.493
2	25	90	30	B301046937225	2.569
2	25	90	40	B301046947225	2.969
2	25	100	22.5	B301046117225	2.645
2	25	100	25	B301046127225	2.670
2	25	100	30	B301046137225	2.803
2	25	100	40	B301046147225	3.135

# SHELVES

## DOUBLE-SIDED STEEL TOP SHELVES - 47 MM FRONTEDGE - FREESTANDING - WITH BRACKETS

### Double-sided steel top shelf with brackets - for 1 freestanding bay

2 left and 2 right brackets included.

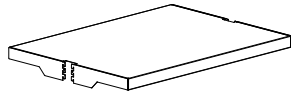

No. of bays	Frontedge cm	Module cm	Shelf depth cm	Item no.	Price DKK
1	47	75	22.5	BB30115719147	1.740
1	47	75	25	BB30115729147	1.801
1	47	75	30	BB30115739147	1.872
1	47	75	40	BB30115749147	2.052
1	47	90	22.5	BB30115919147	1.809
1	47	90	25	BB30115929147	1.873
1	47	90	30	BB30115939147	1.920
1	47	90	40	BB30115949147	2.195
1	47	100	22.5	BB30115119147	1.947
1	47	100	25	BB30115129147	1.973
1	47	100	30	BB30115139147	2.053
1	47	100	40	BB30115149147	2.289

### Double-sided steel top shelf with brackets - for 2 freestanding bays

2 left, 2 middle and 2 right brackets included.

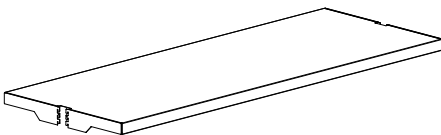

No. of bays	Frontedge cm	Module cm	Shelf depth cm	Item no.	Price DKK
2	47	75	22.5	BB30115719247	2.725
2	47	75	25	BB30115729247	2.823
2	47	75	30	BB30115739247	2.946
2	47	75	40	BB30115749247	3.225
2	47	90	22.5	BB30115919247	2.847
2	47	90	25	BB30115929247	2.949
2	47	90	30	BB30115939247	3.029
2	47	90	40	BB30115949247	3.477
2	47	100	22.5	BB30115119247	3.089
2	47	100	25	BB30115129247	3.126
2	47	100	30	BB30115139247	3.263
2	47	100	40	BB30115149247	3.643

# SHELVES

## DOUBLE-SIDED STEEL TOP SHELVES - 47 MM FRONTEDGE - FREESTANDING

### Double-sided steel top shelf without brackets - for 1 freestanding bay

2 left and 2 right brackets must be ordered separately. See page 96.

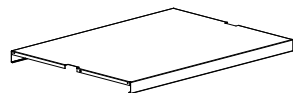

No. of bays	Frontedge cm	Module cm	Shelf depth cm	Item no.	Price DKK
1	47	75	22.5	B301046719147	1.296
1	47	75	25	B301046729147	1.345
1	47	75	30	B301046739147	1.412
1	47	75	40	B301046749147	1.544
1	47	90	22.5	B301046919147	1.365
1	47	90	25	B301046929147	1.417
1	47	90	30	B301046939147	1.460
1	47	90	40	B301046949147	1.687
1	47	100	22.5	B301046119147	1.503
1	47	100	25	B301046129147	1.517
1	47	100	30	B301046139147	1.593
1	47	100	40	B301046149147	1.781

### Double-sided steel top shelf without brackets - for 2 freestanding bays

2 left, 2 middle and 2 right brackets must be ordered separately. See page 96.

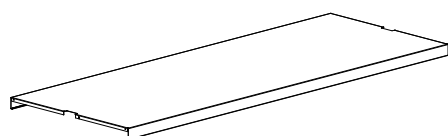

No. of bays	Frontedge cm	Module cm	Shelf depth cm	Item no.	Price DKK
2	47	75	22.5	B301046719247	2.281
2	47	75	25	B301046729247	2.367
2	47	75	30	B301046739247	2.486
2	47	75	40	B301046749247	2.717
2	47	90	22.5	B301046919247	2.403
2	47	90	25	B301046929247	2.493
2	47	90	30	B301046939247	2.569
2	47	90	40	B301046949247	2.969
2	47	100	22.5	B301046119247	2.645
2	47	100	25	B301046129247	2.670
2	47	100	30	B301046139247	2.803
2	47	100	40	B301046149247	3.135

# SHELVES

## DOUBLE-SIDED STEEL TOP SHELVES - 47 MM FRONTEDGE - OUTER - WITH BRACKETS

### Double-sided steel top shelf with brackets - for 1 outer bay

1 left, 1 right and 1 double bracket included.

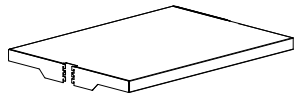

No. of bays	Frontedge cm	Module cm	Shelf depth cm	Item no.	Price DKK
1	47	75	22.5	BB30115718147	1.633
1	47	75	25	BB30115728147	1.694
1	47	75	30	BB30115738147	1.765
1	47	75	40	BB30115748147	1.935
1	47	90	22.5	BB30115918147	1.702
1	47	90	25	BB30115928147	1.766
1	47	90	30	BB30115938147	1.813
1	47	90	40	BB30115948147	2.078
1	47	100	22.5	BB30115118147	1.840
1	47	100	25	BB30115128147	1.866
1	47	100	30	BB30115138147	1.946
1	47	100	40	BB30115148147	2.172

### Double-sided steel top shelf with brackets - for 2 outer bays

1 left, 1 right, 1 double and 2 middle brackets included.

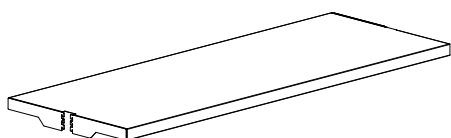

No. of bays	Frontedge cm	Module cm	Shelf depth cm	Item no.	Price DKK
2	47	75	22.5	BB30115718247	2.618
2	47	75	25	BB30115728247	2.716
2	47	75	30	BB30115738247	2.839
2	47	75	40	BB30115748247	3.108
2	47	90	22.5	BB30115918247	2.740
2	47	90	25	BB30115928247	2.842
2	47	90	30	BB30115938247	2.922
2	47	90	40	BB30115948247	3.360
2	47	100	22.5	BB30115118247	2.982
2	47	100	25	BB30115128247	3.019
2	47	100	30	BB30115138247	3.156
2	47	100	40	BB30115148247	3.526

# SHELVES

## DOUBLE-SIDED STEEL TOP SHELVES - 47 MM FRONTEDGE - OUTER

### Double-sided steel top shelf without brackets - for 1 outer bay

1 left, 1 right and 1 double bracket must be ordered separately. See page 96.

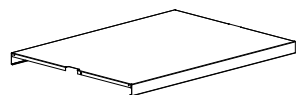

No. of bays	Frontedge cm	Module cm	Shelf depth cm	Item no.	Price DKK
1	47	75	22.5	B301046718147	1.296
1	47	75	25	B301046728147	1.345
1	47	75	30	B301046738147	1.412
1	47	75	40	B301046748147	1.544
1	47	90	22.5	B301046918147	1.365
1	47	90	25	B301046928147	1.417
1	47	90	30	B301046938147	1.460
1	47	90	40	B301046948147	1.687
1	47	100	22.5	B301046118147	1.503
1	47	100	25	B301046128147	1.517
1	47	100	30	B301046138147	1.593
1	47	100	40	B301046148147	1.781

### Double-sided steel top shelf without brackets - for 2 outer bays

1 left, 1 right, 1 double and 2 middle brackets must be ordered separately. See page 96.

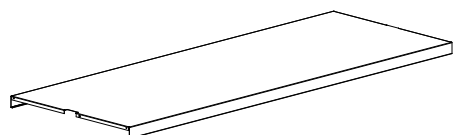

No. of bays	Frontedge cm	Module cm	Shelf depth cm	Item no.	Price DKK
2	47	75	22.5	B301046718247	2.281
2	47	75	25	B301046728247	2.367
2	47	75	30	B301046738247	2.486
2	47	75	40	B301046748247	2.717
2	47	90	22.5	B301046918247	2.403
2	47	90	25	B301046928247	2.493
2	47	90	30	B301046938247	2.569
2	47	90	40	B301046948247	2.969
2	47	100	22.5	B301046118247	2.645
2	47	100	25	B301046128247	2.670
2	47	100	30	B301046138247	2.803
2	47	100	40	B301046148247	3.135

# SHELVES

## DOUBLE-SIDED STEEL TOP SHELVES - 47 MM FRONTEDGE - INTERMEDIATE - WITH BRACKETS

### Double-sided steel top shelf with brackets - for 1 intermediate bay

2 double brackets included.

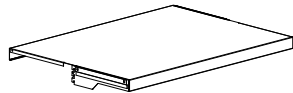

No. of bays	Frontedge cm	Module cm	Shelf depth cm	Item no.	Price DKK
1	47	75	22.5	BB30115717147	1.526
1	47	75	25	BB30115727147	1.587
1	47	75	30	BB30115737147	1.658
1	47	75	40	BB30115747147	1.818
1	47	90	22.5	BB30115917147	1.595
1	47	90	25	BB30115927147	1.659
1	47	90	30	BB30115937147	1.706
1	47	90	40	BB30115947147	1.961
1	47	100	22.5	BB30115117147	1.733
1	47	100	25	BB30115127147	1.759
1	47	100	30	BB30115137147	1.839
1	47	100	40	BB30115147147	2.055

### Double-sided steel top shelf with brackets - for 2 intermediate bays

2 double and 2 middle brackets included.

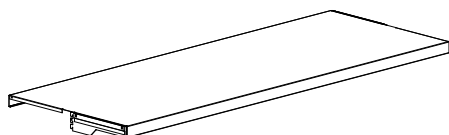

No. of bays	Frontedge cm	Module cm	Shelf depth cm	Item no.	Price DKK
2	47	75	22.5	BB30115717247	2.511
2	47	75	25	BB30115727247	2.609
2	47	75	30	BB30115737247	2.732
2	47	75	40	BB30115747247	2.991
2	47	90	22.5	BB30115917247	2.633
2	47	90	25	BB30115927247	2.735
2	47	90	30	BB30115937247	2.815
2	47	90	40	BB30115947247	3.243
2	47	100	22.5	BB30115117247	2.875
2	47	100	25	BB30115127247	2.912
2	47	100	30	BB30115137247	3.049
2	47	100	40	BB30115147247	3.409

# SHELVES

## DOUBLE-SIDED STEEL TOP SHELVES - 47 MM FRONTEDGE - INTERMEDIATE

### Double-sided steel top shelf without brackets - for 1 intermediate bay

2 double brackets must be ordered separately. See page 96.

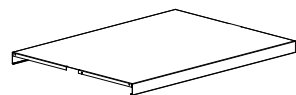

No. of bays	Frontedge cm	Module cm	Shelf depth cm	Item no.	Price DKK
1	47	75	22.5	B301046717147	1.296
1	47	75	25	B301046727147	1.345
1	47	75	30	B301046737147	1.412
1	47	75	40	B301046747147	1.544
1	47	90	22.5	B301046917147	1.365
1	47	90	25	B301046927147	1.417
1	47	90	30	B301046937147	1.460
1	47	90	40	B301046947147	1.687
1	47	100	22.5	B301046117147	1.503
1	47	100	25	B301046127147	1.517
1	47	100	30	B301046137147	1.593
1	47	100	40	B301046147147	1.781

### Double-sided steel top shelf without brackets - for 2 intermediate bays

2 double and 2 middle brackets must be ordered separately. See page 96.

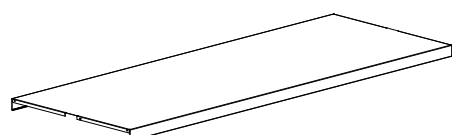

No. of bays	Frontedge cm	Module cm	Shelf depth cm	Item no.	Price DKK
2	47	75	22.5	B301046717247	2.281
2	47	75	25	B301046727247	2.367
2	47	75	30	B301046737247	2.486
2	47	75	40	B301046747247	2.717
2	47	90	22.5	B301046917247	2.403
2	47	90	25	B301046927247	2.493
2	47	90	30	B301046937247	2.569
2	47	90	40	B301046947247	2.969
2	47	100	22.5	B301046117247	2.645
2	47	100	25	B301046127247	2.670
2	47	100	30	B301046137247	2.803
2	47	100	40	B301046147247	3.135

# SHELVES

## BRACKETS FOR STEEL TOP SHELVES

### Steel bracket for steel top shelf B301046 and B301049

Max. load of 25 kg.

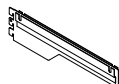
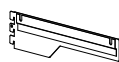
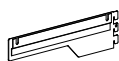

Type	Shelf depth cm	Item no.	Price DKK
Left	22.5	B30102917	111
Left	25	B30102927	114
Left	30	B30102937	115
Left	40	B30102947	127
Right	22.5	B30102918	111
Right	25	B30102928	114
Right	30	B30102938	115
Right	40	B30102948	127
Double	22.5	B30102919	115
Double	25	B30102929	121
Double	30	B30102939	123
Double	40	B30102949	137

### Steel middle bracket for steel top shelf B301046 and B301049 over 2 bays

Max. load of 25 kg.



Frontedge cm	Shelf depth cm	Item no.	Price DKK
25	22.5	B301047125	128
25	25	B301047225	128
25	30	B301047325	128
25	40	B301047425	128
47	22.5	B301047147	128
47	25	B301047247	128
47	30	B301047347	128
47	40	B301047447	128





# SHELVES

## SINGLE-SIDED LONDON STEEL OVERLAYING TOP PLATE - 30 MM FRONTEDGE

### Single-sided London steel overlaying top plate - freestanding

30 mm front edge. Incl. brackets.	Module cm	Shelf depth cm	Bays	Art. no.	Price DKK
	75	22.5	1	B301628711019	870
	75	25	1	B301628721019	916
	75	30	1	B301628731019	1.018
	75	40	1	B301628741019	1.361
	90	22.5	1	B301628911019	1.027
	90	25	1	B301628921019	1.081
	90	30	1	B301628931019	1.220
	90	40	1	B301628941019	1.571
	100	22.5	1	B301628111019	1.312
	100	25	1	B301628121019	1.381
	100	30	1	B301628131019	1.559
	100	40	1	B301628141019	2.007
	75	22.5	2	B301628711029	1.709
	75	25	2	B301628721029	1.799
	75	30	2	B301628731029	1.980
	75	40	2	B301628741029	2.567
	90	22.5	2	B301628911029	1.996
	90	25	2	B301628921029	2.097
	90	30	2	B301628931029	2.344
	90	40	2	B301628941029	3.072
	100	22.5	2	B301628111029	2.550
	100	25	2	B301628121029	2.680
	100	30	2	B301628131029	2.995
	100	40	2	B301628141029	3.925

### Single-sided London steel overlaying top plate - outer

30 mm front edge. Incl. brackets.	Module cm	Shelf depth cm	Bays	Art. no.	Price DKK
	75	22.5	1	B301628711017	911
	75	25	1	B301628721017	959
	75	30	1	B301628731017	1.069
	75	40	1	B301628741017	1.361
	90	22.5	1	B301628911017	1.069
	90	25	1	B301628921017	1.124
	90	30	1	B301628931017	1.220
	90	40	1	B301628941017	1.571
	100	22.5	1	B301628111017	1.366
	100	25	1	B301628121017	1.436
	100	30	1	B301628131017	1.559
	100	40	1	B301628141017	2.007
	75	22.5	2	B301628711027	1.702
	75	25	2	B301628721027	1.792
	75	30	2	B301628731027	1.971
	75	40	2	B301628741027	2.595
	90	22.5	2	B301628911027	1.994
	90	25	2	B301628921027	2.096
	90	30	2	B301628931027	2.371
	90	40	2	B301628941027	3.072
	100	22.5	2	B301628111027	2.548
	100	25	2	B301628121027	2.678
	100	30	2	B301628131027	3.030
	100	40	2	B301628141027	3.925

# SHELVES

## SINGLE-SIDED LONDON STEEL OVERLAYING TOP PLATE - 30 MM FRONTEDGE

### Single-sided London steel overlaying top plate - intermediate

30 mm front edge. Incl. brackets.	Module cm	Shelf depth cm	Bays	Art. no.	Price DKK
	75	22.5	1	B301628711018	872
	75	25	1	B301628721018	917
	75	30	1	B301628731018	1.018
	75	40	1	B301628741018	1.303
	90	22.5	1	B301628911018	1.027
	90	25	1	B301628921018	1.081
	90	30	1	B301628931018	1.189
	90	40	1	B301628941018	1.513
	100	22.5	1	B301628111018	1.312
	100	25	1	B301628121018	1.381
	100	30	1	B301628131018	1.519
	100	40	1	B301628141018	1.933
	75	22.5	2	B301628711028	1.672
	75	25	2	B301628721028	1.761
	75	30	2	B301628731028	1.979
	75	40	2	B301628741028	2.533
	90	22.5	2	B301628911028	1.984
	90	25	2	B301628921028	2.089
	90	30	2	B301628931028	2.310
	90	40	2	B301628941028	3.009
	100	22.5	2	B301628111028	2.535
	100	25	2	B301628121028	2.669
	100	30	2	B301628131028	2.952
	100	40	2	B301628141028	3.845

# SHELVES

## DOUBLE-SIDED LONDON STEEL OVERLAYING TOP PLATE - 30 MM FRONTEDGE

### Double-sided London steel overlaying top plate - freestanding

30 mm front edge. Incl. brackets.	Module cm	Shelf depth cm	Bays	Art. no.	Price DKK
	75	22.5	1	B301628712019	1.529
	75	25	1	B301628722019	1.610
	75	30	1	B301628732019	1.820
	75	40	1	B301628742019	2.472
	90	22.5	1	B301628912019	1.820
	90	25	1	B301628922019	1.916
	90	30	1	B301628932019	2.119
	90	40	1	B301628942019	2.865
	100	22.5	1	B301628112019	2.326
	100	25	1	B301628122019	2.448
	100	30	1	B301628132019	2.708
	100	40	1	B301628142019	3.661
	75	22.5	2	B301628712029	2.968
	75	25	2	B301628722029	3.124
	75	30	2	B301628732029	3.509
	75	40	2	B301628742029	4.731
	90	22.5	2	B301628912029	3.516
	90	25	2	B301628922029	3.701
	90	30	2	B301628932029	4.190
	90	40	2	B301628942029	5.645
	100	22.5	2	B301628112029	4.493
	100	25	2	B301628122029	4.729
	100	30	2	B301628132029	5.354
	100	40	2	B301628142029	7.213

### Double-sided London steel overlaying top plate - outer

30 mm front edge. Incl. brackets.	Module cm	Shelf depth cm	Bays	Art. no.	Price DKK
	75	22.5	1	B301628712017	1.529
	75	25	1	B301628722017	1.610
	75	30	1	B301628732017	1.858
	75	40	1	B301628742017	2.446
	90	22.5	1	B301628912017	1.820
	90	25	1	B301628922017	1.916
	90	30	1	B301628932017	2.119
	90	40	1	B301628942017	2.833
	100	22.5	1	B301628112017	2.326
	100	25	1	B301628122017	2.448
	100	30	1	B301628132017	2.708
	100	40	1	B301628142017	3.620
	75	22.5	2	B301628712027	2.968
	75	25	2	B301628722027	3.124
	75	30	2	B301628732027	3.577
	75	40	2	B301628742027	4.732
	90	22.5	2	B301628912027	3.450
	90	25	2	B301628922027	3.635
	90	30	2	B301628932027	4.190
	90	40	2	B301628942027	5.511
	100	22.5	2	B301628112027	4.408
	100	25	2	B301628122027	4.645
	100	30	2	B301628132027	5.354
	100	40	2	B301628142027	7.042

# SHELVES

## DOUBLE-SIDED LONDON STEEL OVERLAYING TOP PLATE - 30 MM FRONTEDGE

### Double-sided London steel overlaying top plate - intermediate

30 mm front edge. Incl. brackets.	Module cm	Shelf depth cm	Bays	Art. no.	Price DKK
	75	22.5	1	B301628712018	1.532
	75	25	1	B301628722018	1.612
	75	30	1	B301628732018	1.822
	75	40	1	B301628742018	2.416
	90	22.5	1	B301628912018	1.820
	90	25	1	B301628922018	1.916
	90	30	1	B301628932018	2.143
	90	40	1	B301628942018	2.805
	100	22.5	1	B301628112018	2.326
	100	25	1	B301628122018	2.448
	100	30	1	B301628132018	2.738
	100	40	1	B301628142018	3.584
	75	22.5	2	B301628712028	2.970
	75	25	2	B301628722028	3.127
	75	30	2	B301628732028	3.512
	75	40	2	B301628742028	4.704
	90	22.5	2	B301628912028	3.450
	90	25	2	B301628922028	3.635
	90	30	2	B301628932028	4.108
	90	40	2	B301628942028	5.482
	100	22.5	2	B301628112028	4.408
	100	25	2	B301628122028	4.645
	100	30	2	B301628132028	5.249
	100	40	2	B301628142028	7.005

# SHELVES

## WOODEN SHELVES

See below for overview of standard wooden shelves:

---

### B401020 - WOODEN SHELF WITH STEEL BACKEDGE

Details:

- Module 750/900 mm
- Depth 225/250/300/400 mm
- Steel backedge H47 mm
- Backedge book support
- Steel plate brackets
- Max. weight 80 kg.
- Straight
- Use with steel top shelf B401003, B401011, B301049, B301049 and wooden top shelf B401020

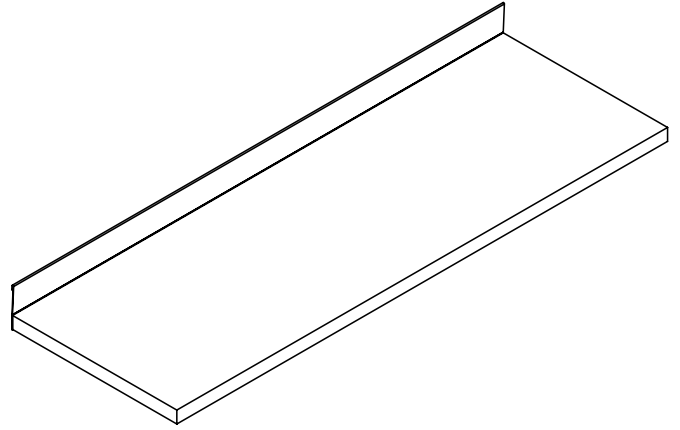

# SHELVES

## WOODEN SHELVES

### Wooden shelf with steel backedge and without brackets - for backedge book support

Brackets must be ordered separately.  
See below.

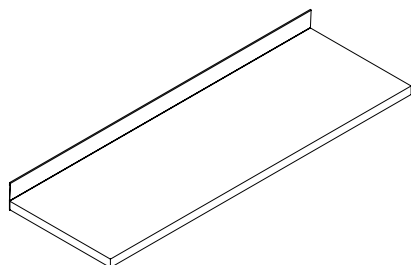

Module cm	Shelf depth cm	Item no. Painted	Price DKK	Item no. Veneer	Price DKK
75	22.5	B4010201175	750	B4010201171	1.050
75	25	B4010201275	750	B4010201271	1.050
75	30	B4010201375	750	B4010201371	1.050
75	40	B4010201475	907	B4010201471	1.270
90	22.5	B4010201195	750	B4010201191	1.050
90	25	B4010201295	750	B4010201291	1.050
90	30	B4010201395	750	B4010201391	1.050
90	40	B4010201495	907	B4010201491	1.270

### Steel plate bracket for wooden shelf

H15 cm. For both starter and add-on bays, one left bracket and one right bracket are needed.

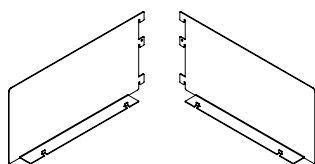

Type	Shelf depth cm	Item no.	Price DKK
Left	22.5	B30110618	163
Left	25	B30110628	166
Left	30	B30110638	174
Left	40	B30110648	181
Right	22.5	B30110619	163
Right	25	B30110629	166
Right	30	B30110639	174
Right	40	B30110649	181

# SHELVES

## WOODEN TOP SHELVES AND LONDON OVERLAYING TOP PLATE

See below for overview of standard wooden top shelves and overlaying top plate:

---

### B401020 - SINGLE-SIDED WOODEN TOP SHELF

Details:

- Module 750/900/1000 mm
- Depth 225/250/300/400 mm
- Steel brackets
- Max. weight 25 kg.

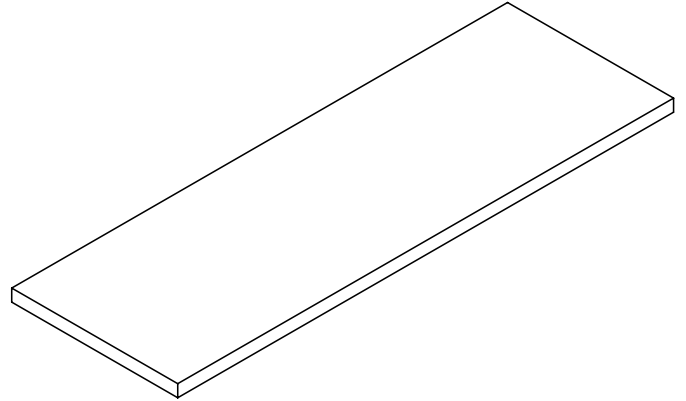

---

### B302130 - FSC SINGLE- & DOUBLE-SIDED LONDON WOODEN OVERLAYING TOP PLATE

Details:

- Module 750/900/1000 mm
- Depth 225/250/300/400 mm
- Freestanding/outer/intermediate
- Steel brackets
- Max. weight 25 kg.
- 1/2/3 bays



# SHELVES

## WOODEN TOP SHELVES - FOR BACKEDGE BOOK SUPPORT

Wooden top shelf without brackets - to be used with steel shelves for backedge book support

Brackets must be ordered separately.  
See below.

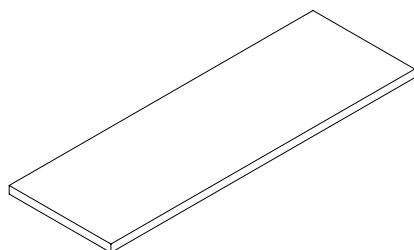

Module cm	Shelf depth cm	Item no. Painted	Price DKK	Item no. Veneer	Price DKK
75	22.5	B4010200175	848	B4010200171	1.187
75	25	B4010200275	848	B4010200271	1.187
75	30	B4010200375	848	B4010200371	1.187
75	40	B4010200475	887	B4010200471	1.241
90	22.5	B4010200195	848	B4010200191	1.187
90	25	B4010200295	848	B4010200291	1.187
90	30	B4010200395	848	B4010200391	1.187
90	40	B4010200495	887	B4010200491	1.241
100	22.5	B4010200115	944	B4010200111	1.322
100	25	B4010200215	944	B4010200211	1.322
100	30	B4010200315	944	B4010200311	1.322
100	40	B4010200415	986	B4010200411	1.380

### Steel bracket for wooden top shelf

H7.5 cm. For both starter and add-on bays, one left bracket and one right bracket are needed.

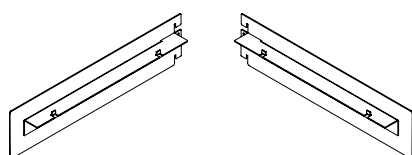

Type	Shelf depth cm	Item no.	Price DKK
Left	22.5	B30110018	141
Left	25	B30110028	159
Left	30	B30110038	159
Left	40	B30110048	210
Right	22.5	B30110019	141
Right	25	B30110029	159
Right	30	B30110039	159
Right	40	B30110049	210

# SHELVES

## SINGLE-SIDED LONDON WOODEN OVERLAYING TOP PLATES - FREESTANDING - WITH BRACKETS

### Single-sided FSC London wooden overlaying top plate - freestanding

30 mm front edge. Incl. brackets.

Module cm	Shelf depth cm	Bays	Art. no.	Price DKK
75	22.5	1	B302136171019	872
75	25	1	B302136271019	917
75	30	1	B302136371019	1.023
75	40	1	B302136471019	1.366
90	22.5	1	B302136191019	1.034
90	25	1	B302136291019	1.090
90	30	1	B302136391019	1.228
90	40	1	B302136491019	1.581
100	22.5	1	B302136111019	1.101
100	25	1	B302136211019	1.159
100	30	1	B302136311019	1.322
100	40	1	B302136411019	1.698
75	22.5	2	B302136171029	1.713
75	25	2	B302136271029	1.803
75	30	2	B302136371029	1.985
75	40	2	B302136471029	2.578
90	22.5	2	B302136191029	2.002
90	25	2	B302136291029	2.108
90	30	2	B302136391029	2.355
90	40	2	B302136491029	3.084
100	22.5	2	B302136111029	2.135
100	25	2	B302136211029	2.250
100	30	2	B302136311029	2.549
100	40	2	B302136411029	3.327
75	22.5	3	B302136171039	2.457
75	25	3	B302136271039	2.584
75	30	3	B302136371039	2.901
75	40	3	B302136471039	3.815
90	22.5	3	B302136191039	2.943
90	25	3	B302136291039	3.098
90	30	3	B302136391039	3.484
90	40	3	B302136491039	4.574

# SHELVES

## SINGLE-SIDED LONDON WOODEN OVERLAYING TOP PLATES - OUTER - WITH BRACKETS

### Single-sided FSC London wooden overlaying top plate - outer

30 mm front edge. Incl. brackets.

Module cm	Shelf depth cm	Bays	Art. no.	Price DKK
75	22.5	1	B302136171017	917
75	25	1	B302136271017	966
75	30	1	B302136371017	1.071
75	40	1	B302136471017	1.367
90	22.5	1	B302136191017	1.072
90	25	1	B302136291017	1.129
90	30	1	B302136391017	1.228
90	40	1	B302136491017	1.581
100	22.5	1	B302136111017	1.128
100	25	1	B302136211017	1.188
100	30	1	B302136311017	1.350
100	40	1	B302136411017	1.729
75	22.5	2	B302136171027	1.709
75	25	2	B302136271027	1.800
75	30	2	B302136371027	1.977
75	40	2	B302136471027	2.607
90	22.5	2	B302136191027	2.002
90	25	2	B302136291027	2.108
90	30	2	B302136391027	2.383
90	40	2	B302136491027	3.084
100	22.5	2	B302136111027	2.167
100	25	2	B302136211027	2.282
100	30	2	B302136311027	2.608
100	40	2	B302136411027	3.328
75	22.5	3	B302136171037	2.538
75	25	3	B302136271037	2.670
75	30	3	B302136371037	2.933
75	40	3	B302136471037	3.843
90	22.5	3	B302136191037	2.973
90	25	3	B302136291037	3.129
90	30	3	B302136391037	3.507
90	40	3	B302136491037	4.564

# SHELVES

## SINGLE-SIDED LONDON WOODEN OVERLAYING TOP PLATES - INTERMEDIATE - WITH BRACKETS

Single-sided FSC London wooden overlaying top plate - intermediate

30 mm front edge. Incl. brackets.

Module cm	Shelf depth cm	Bays	Art. no.	Price DKK
75	22.5	1	B302136171018	874
75	25	1	B302136271018	919
75	30	1	B302136371018	1.024
75	40	1	B302136471018	1.307
90	22.5	1	B302136191018	1.030
90	25	1	B302136291018	1.084
90	30	1	B302136391018	1.195
90	40	1	B302136491018	1.517
100	22.5	1	B302136111018	1.123
100	25	1	B302136211018	1.182
100	30	1	B302136311018	1.295
100	40	1	B302136411018	1.667
75	22.5	2	B302136171028	1.676
75	25	2	B302136271028	1.763
75	30	2	B302136371028	1.985
75	40	2	B302136471028	2.545
90	22.5	2	B302136191028	1.992
90	25	2	B302136291028	2.096
90	30	2	B302136391028	2.323
90	40	2	B302136491028	3.021
100	22.5	2	B302136111028	2.135
100	25	2	B302136211028	2.250
100	30	2	B302136311028	2.515
100	40	2	B302136411028	3.266
75	22.5	3	B302136171038	2.458
75	25	3	B302136271038	2.585
75	30	3	B302136371038	2.957
75	40	3	B302136471038	3.781
90	22.5	3	B302136191038	2.943
90	25	3	B302136291038	3.098
90	30	3	B302136391038	3.507
90	40	3	B302136491038	4.528

# SHELVES

## DOUBLE-SIDED LONDON WOODEN OVERLAYING TOP PLATES - FREESTANDING - WITH BRACKETS

### Double-sided FSC London wooden overlaying top plate - freestanding

30 mm front edge. Incl. brackets.	Module cm	Shelf depth cm	Bays	Art. no.	Price DKK
	75	22.5	1	B302136172019	1.535
	75	25	1	B302136272019	1.620
	75	30	1	B302136372019	1.828
	75	40	1	B302136472019	2.483
	90	22.5	1	B302136192019	1.828
	90	25	1	B302136292019	1.923
	90	30	1	B302136392019	2.128
	90	40	1	B302136492019	2.874
	100	22.5	1	B302136112019	1.966
	100	25	1	B302136212019	2.069
	100	30	1	B302136312019	2.437
	100	40	1	B302136412019	3.144
	75	22.5	2	B302136172029	2.980
	75	25	2	B302136272029	3.138
	75	30	2	B302136372029	3.524
	75	40	2	B302136472029	4.753
	90	22.5	2	B302136192029	3.531
	90	25	2	B302136292029	3.719
	90	30	2	B302136392029	4.208
	90	40	2	B302136492029	5.670
	100	22.5	2	B302136112029	3.808
	100	25	2	B302136212029	4.007
	100	30	2	B302136312029	4.670
	100	40	2	B302136412029	6.106
	75	22.5	3	B302136172039	4.395
	75	25	3	B302136272039	4.626
	75	30	3	B302136372039	5.284
	75	40	3	B302136472039	7.050
	90	22.5	3	B302136192039	5.238
	90	25	3	B302136292039	5.513
	90	30	3	B302136392039	6.247
	90	40	3	B302136492039	8.410

# SHELVES

## DOUBLE-SIDED LONDON WOODEN OVERLAYING TOP PLATES - OUTER - WITH BRACKETS

Double-sided FSC London wooden overlaying top plate - outer

30 mm front edge. Incl. brackets.

Module cm	Shelf depth cm	Bays	Art. no.	Price DKK
75	22.5	1	B302136172017	1.540
75	25	1	B302136272017	1.621
75	30	1	B302136372017	1.863
75	40	1	B302136472017	2.457
90	22.5	1	B302136192017	1.828
90	25	1	B302136292017	1.923
90	30	1	B302136392017	2.129
90	40	1	B302136492017	2.848
100	22.5	1	B302136112017	1.966
100	25	1	B302136212017	2.069
100	30	1	B302136312017	2.338
100	40	1	B302136412017	3.119
75	22.5	2	B302136172027	2.980
75	25	2	B302136272027	3.138
75	30	2	B302136372027	3.596
75	40	2	B302136472027	4.755
90	22.5	2	B302136192027	3.468
90	25	2	B302136292027	3.649
90	30	2	B302136392027	4.208
90	40	2	B302136492027	5.534
100	22.5	2	B302136112027	3.808
100	25	2	B302136212027	4.007
100	30	2	B302136312027	4.547
100	40	2	B302136412027	6.076
75	22.5	3	B302136172037	4.395
75	25	3	B302136272037	4.626
75	30	3	B302136372037	5.229
75	40	3	B302136472037	7.019
90	22.5	3	B302136192037	5.238
90	25	3	B302136292037	5.513
90	30	3	B302136392037	6.247
90	40	3	B302136492037	8.221

# SHELVES

## DOUBLE-SIDED LONDON WOODEN OVERLAYING TOP PLATES - INTERMEDIATE - WITH BRACKETS

### Double-sided FSC London wooden overlaying top plate - intermediate

30 mm front edge. Incl. brackets.	Module cm	Shelf depth cm	Bays	Art. no.	Price DKK
	75	22.5	1	B302136172018	1.542
	75	25	1	B302136272018	1.623
	75	30	1	B302136372018	1.829
	75	40	1	B302136472018	2.425
	90	22.5	1	B302136192018	1.828
	90	25	1	B302136292018	1.923
	90	30	1	B302136392018	2.151
	90	40	1	B302136492018	2.819
	100	22.5	1	B302136112018	1.968
	100	25	1	B302136212018	2.071
	100	30	1	B302136312018	2.340
	100	40	1	B302136412018	3.088
	75	22.5	2	B302136172028	2.983
	75	25	2	B302136272028	3.139
	75	30	2	B302136372028	3.529
	75	40	2	B302136472028	4.721
	90	22.5	2	B302136192028	3.469
	90	25	2	B302136292028	3.650
	90	30	2	B302136392028	4.129
	90	40	2	B302136492028	5.504
	100	22.5	2	B302136112028	3.808
	100	25	2	B302136212028	4.010
	100	30	2	B302136312028	4.548
	100	40	2	B302136412028	6.106
	75	22.5	3	B302136172038	4.396
	75	25	3	B302136272038	4.627
	75	30	3	B302136372038	5.230
	75	40	3	B302136472038	7.021
	90	22.5	3	B302136192038	5.238
	90	25	3	B302136292038	5.513
	90	30	3	B302136392038	6.128
	90	40	3	B302136492038	8.195

# SHELVES

## BRACKETS FOR LONDON WOODEN TOP PLATES

---

### Steel top bracket for London wooden top plate

When sold separately, it is necessary to order two screws per bracket, item no. 1147024016.

Shelf depth cm
22.5
25
30
40

Item no. Left	Price DKK	Item no. Right	Price DKK
B30120018	98	B30120019	98
B30120028	105	B30120029	105
B30120038	105	B30120039	105
B30120048	105	B30120049	105

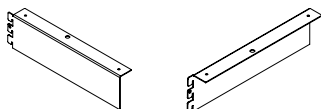



# SHELVES

## ACCESSOIRES

### Reinforcement for shelf

All depths	Module cm	Item no.	Price DKK
	75	B3020407	123
	90	B3020409	132
	100	B3020401	140

### Acrylic backedge

For shelf BB40077xxxxx and B401013xx.  
H6 cm.

Module cm	Item no.	Price DKK
75	B4010127	-
90	B4010129	-
100	B4010121	-

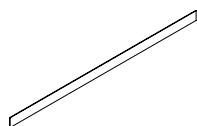

### Shelf bridge for shelf without backedge for 60/30 & 80/30 Classic upright

Used to minimize gap between top shelves without steel backedge and without sign profile on double-sided shelving. W6 cm for 60/30, W8 cm for 80/30.

Module cm	Width cm	Item no.	Price DKK
75	6	B3020307	152
90	6	B3020309	155
100	6	B3020301	168
75	8	B3020357	152
90	8	B3020359	155
100	8	B3020351	168

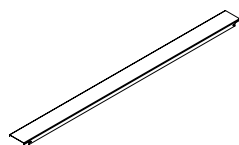



# ACCESSORIES

## BOOK SUPPORTS

### Backedge book support for straight shelves with steel backedge

Nickel plated steel, Ø6 mm, with a nylon glider. For shelf BB40076xxxxx and B401001xx.

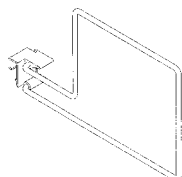

Height cm	Shelf depth cm	Type	Item no.	Price DKK
16,3	22.5/25	For books on left side of book support	B4011221	127
16,3	30	For books on left side of book support	B4011222	137
24,3	25/30	For books on left side of book support	B4011223	178
16,3	22.5/25	For books on right side of book support	B4011224	127
16,3	30	For books on right side of book support	B4011225	137

### Hanging book support for shelves with acrylic backedge

Available in chromed steel or BCI standard steel colours. For shelf BB40077xxxxx and B401013xx



Height cm	Item no.	Price DKK
20	B4011242	68
25	B4011245	73

### Rail for hanging book support for wooden shelves

Incl. fittings.

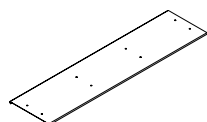

Width cm	Shelf depth cm	Item no.	Price DKK
75	25, 30, 40	B4022007	244
90	25, 30, 40	B4022009	244

### Angled book support

W15 x H15 x D15 cm.

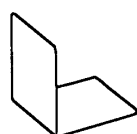

Item no.	Price DKK
B401120	78

# ACCESSORIES

## BROWSERS

### Single steel browser - one level - without/with pull-out frame

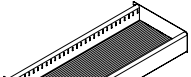
W75 cm. Incl. fittings and rubber mat. Excl. tubes	Height cm	Depth cm	No. of dividers	Item no.	Price	Item no.	Price
				Without pull-out function	DKK	With pull-out function	DKK
	10	30 <sup>*1</sup>	0	B3052007100	1.935	B3052027500	3.521
	10	30	1	B3052007101	2.047	B3052027501	3.635
	10	30	2	B3052007102	2.160	B3052027502	3.747
	10	30	4	B3052007104	2.381	B3052027504	3.972

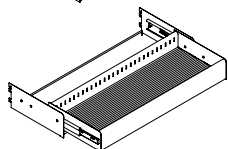

### Single steel browser - one level - without/with pull-out frame

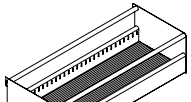
W75 cm. Incl. fittings, rubber mat and tubes.	Height cm	Depth cm	No. of dividers	Item no.	Price	Item no.	Price
				Without pull-out function	DKK	With pull-out function	DKK
	20	30 <sup>*2</sup>	0	B3052007200	2.512	B3052027600	4.101
	20	30	1	B3052007201	2.623	B3052027601	4.211
	20	30	2	B3052007202	2.735	B3052027602	4.322
	20	30	4	B3052007204	2.958	B3052027604	4.543

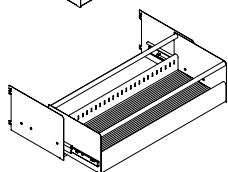

### Single steel browser - one level - without/with pull-out frame

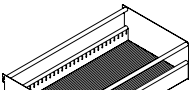
W75 cm. Incl. fittings, rubber mat and tubes.	Height cm	Depth cm	No. of dividers	Item no.	Price	Item no.	Price
				Without pull-out function	DKK	With pull-out function	DKK
	20	40 <sup>*3</sup>	0	B3052007300	2.637	B3052027700	4.223
	20	40	1	B3052007301	2.768	B3052027701	4.352
	20	40	2	B3052007302	2.896	B3052027702	4.482
	20	40	4	B3052007304	3.155	B3052027704	4.742

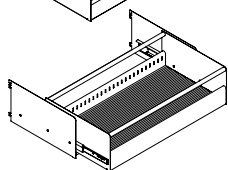

### Double steel browser - two levels - without/with pull-out frame

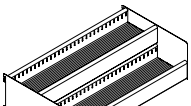
W75 cm. Incl. fittings and rubber mat. Excl. tubes	Height cm	Depth cm	No. of dividers	Item no.	Price	Item no.	Price
				Without pull-out function	DKK	With pull-out function	DKK
	20	40 <sup>*4</sup>	0	B3052007400	3.485	B3052027800	5.070
	20	40	2	B3052007402	3.659	B3052027802	5.248
	20	40	4	B3052007404	3.846	B3052027804	5.429
	20	40	8	B3052007408	4.207	B3052027808	5.794

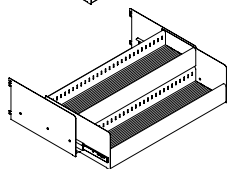

# ACCESSORIES

## BROWSERS

### Single steel browser - one level - without/with pull-out frame

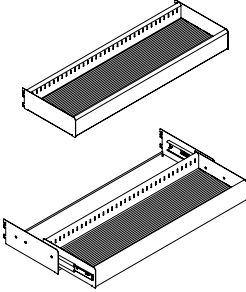
W90 cm. Incl. fittings and rubber mat. Excl. tubes	Height cm	Depth cm	No. of dividers	Item no. Without pull-out function	Price DKK	Item no. With pull-out function	Price DKK
	10	30 *1	0	B3052009100	1.935	B3052029500	3.521
	10	30	2	B3052009101	2.047	B3052029501	3.635
	10	30	4	B3052009102	2.160	B3052029502	3.747
	10	30	5	B3052009104	2.381	B3052029504	3.972

### Single steel browser - one level - without/with pull-out frame

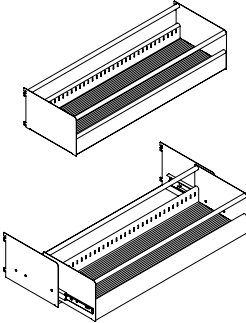
W90 cm. Incl. fittings, rubber mat and tubes.	Height cm	Depth cm	No. of dividers	Item no. Without pull-out function	Price DKK	Item no. With pull-out function	Price DKK
	20	30 *2	0	B3052009200	2.512	B3052029600	4.101
	20	30	2	B3052009201	2.623	B3052029601	4.211
	20	30	4	B3052009202	2.735	B3052029602	4.322
	20	30	5	B3052009204	2.958	B3052029604	4.543

### Single steel browser - one level - without/with pull-out frame

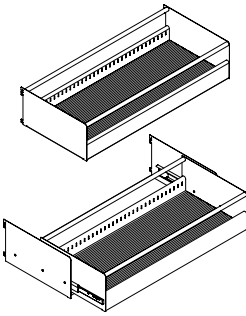
W90 cm. Incl. fittings, rubber mat and tubes.	Height cm	Depth cm	No. of dividers	Item no. Without pull-out function	Price DKK	Item no. With pull-out function	Price DKK
	20	40 *3	0	B3052009300	2.637	B3052029700	4.223
	20	40	2	B3052009301	2.768	B3052029701	4.352
	20	40	4	B3052009302	2.896	B3052029702	4.482
	20	40	5	B3052009304	3.155	B3052029704	4.742

### Double steel browser - two levels - without/with pull-out frame

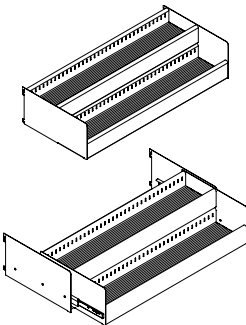
W90 cm. Incl. fittings and rubber mat. Excl. tubes	Height cm	Depth cm	No. of dividers	Item no. Without pull-out function	Price DKK	Item no. With pull-out function	Price DKK
	20	40 *4	0	B3052009400	3.485	B3052029800	5.070
	20	40	4	B3052009402	3.659	B3052029802	5.248
	20	40	8	B3052009404	3.846	B3052029804	5.429
	20	40	10	B3052009408	4.207	B3052029808	5.794



WE  
ARE  
LIBRARY  
PEOPLE®



# ACCESSORIES

## BROWSERS

### Dividers for single and double steel browser

Chromed steel.

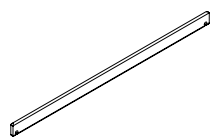

Level	Height cm	Depth cm	Item no.	Price DKK
One	10	30	B4011603	114
One	20	30	B4011603	114
One	20	40	B4011604	132
Two	20	40	B4011601	92

### Capacity examples for 75 cm single/double steel browser without pullout (see page 116)

	Type	W cm	H x D cm	CD cases	DVD cases	CD pockets	Picture books	Comic picture books
				5 rows	5 rows	5 rows	3 rows	2 rows
*1	Single	75	10 x 30	100	75	325	-	-
*2	Single	75	20 x 30	100	75	325	90	40
*3	Single	75	20 x 40	150	105	325	120	50
				2 x 5 rows	2 x 5 rows	2 x 5 rows	3 rows	2 rows
*4	Double	75	20 x 40	130	95	400	-	-

### Capacity examples for 75 cm single/double steel browser with pullout (see page 116)

	Type	W cm	H x D cm	CD cases	DVD cases	CD pockets	Picture books	Comic picture books
				5 rows	5 rows	5 rows	3 rows	2 rows
*1	Single	75 cm	10 x 30	80	60	260	-	-
*2	Single	75 cm	20 x 30	80	60	260	90	40
*3	Single	75 cm	20 x 40	120	84	340	120	50
				2 x 5 rows	2 x 5 rows	2 x 5 rows	3 rows	2 rows
*4	Double	75 cm	20 x 40	104	76	320	-	-

### Capacity examples for 90 cm single/double steel browser without pullout (see page 117)

	Type	W cm	H x D cm	CD cases	DVD cases	CD pockets	Picture books	Comic picture books
				6 rows	6 rows	6 rows	4 rows	3 rows
*1	Single	90 cm	10 x 30	120	90	390	-	-
*2	Single	90 cm	20 x 30	120	90	390	120	60
*3	Single	90 cm	20 x 40	180	126	510	180	75
				2 x 6 rows	2 x 6 rows	2 x 6 rows	4 rows	3 rows
*4	Double	90 cm	20 x 40	156	114	480	-	-

### Capacity examples for 90 cm single/double steel browser with pullout (see page 117)

	Type	W cm	H x D cm	CD cases	DVD cases	CD pockets	Picture books	Comic picture books
				6 rows	6 rows	6 rows	4 rows	3 rows
*1	Single	90 cm	10 x 30	100	75	325	-	-
*2	Single	90 cm	20 x 30	100	75	325	120	60
*3	Single	90 cm	20 x 40	150	105	425	160	75
				2 x 6 rows	2 x 6 rows	2 x 6 rows	4 rows	3 rows
*4	Double	90 cm	20 x 40	130	95	400	-	-



TIDNINGAR

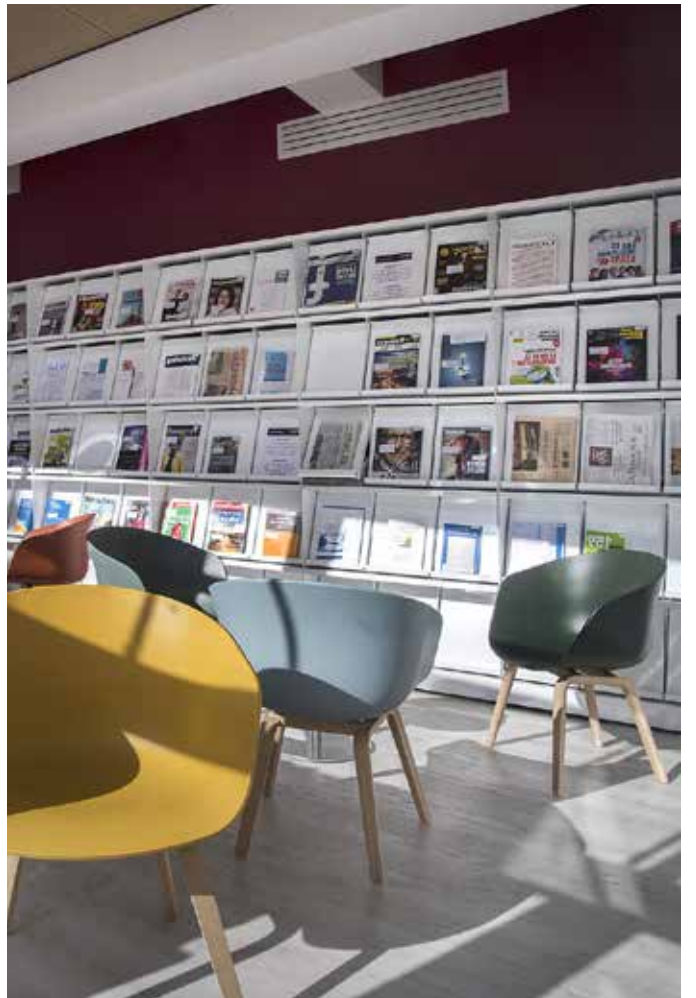



# ACCESSORIES

## DISPLAY & STORAGE - MAGAZINE

### Magazine display - with 1 tip up sloping shelf

W90 x H40 x D40 cm. With space for storage of either magazines piled horizontally or vertical binders (up to 32 cm in height)

Item no.

Price  
DKK

B305100

3.636

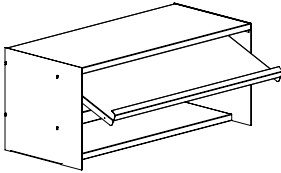

### Magazine display - with 1 tip up sloping shelf and moveable dividers

W90 x H40 x D40 cm. With space for separate storage of either magazines piled horizontally or vertical binders (up to 32 cm in height). Dividers can be moved 5 cm either way.

Item no.

Price  
DKK

B305110

4.270

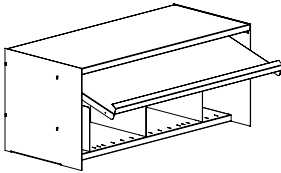

### Magazine display - with 3 tip up sloping shelves

W90 x H40 x D40 cm. With space for separate storage of either magazines piled horizontally or vertical binders (up to 32 cm in height)

Item no.

Price  
DKK

B305120

4.510

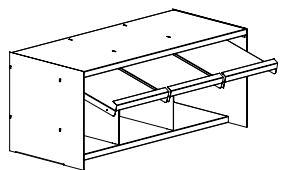



# ACCESSORIES

## DISPLAY & STORAGE - MAGAZINE

### Steel magazine box - Unibox

H320 x D260 x W320 mm. Box and flap lacquered steel. With transparent antireflex foil. Recommended for use on D250 mm steel shelf with/without backedge and wooden shelf without backedge. Can be used on D300 mm shelves. With space for storage of magazines piled horizontally 140 mm.

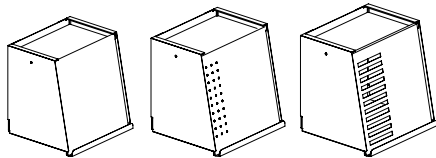

Design	Back wall	Item no.	Price DKK
-	Yes	B405502001	1.669
-	No	B405502000	1.522
With holes	Yes	B405502051	1.743
With holes	No	B405502050	1.598
With slots	Yes	B405502101	1.832
With slots	No	B405502100	1.686

### Steel magazine box

H320 x D260 x W238 mm. Box and flap lacquered steel. Recommended for use on D250 mm steel shelf with/without backedge and wooden shelf without backedge. Can be used on D300 mm shelves. Upright storage of magazines. With space for storage of magazines piled vertically 140 mm.

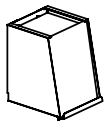

Item no.	Price DKK
B405504	1.871

### Steel cabinet with sliding door

W90 x D40 cm. Incl. lock and 1 shelf.

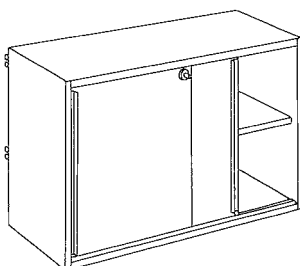

Height cm	Item no.	Price DKK
62.5	B3050306	7.712
80.0	B3050307	8.718



# ACCESSORIES

## DISPLAY & STORAGE - MULTIMEDIA

### Steel pocket book shelf

W90 x H20 x D22.5 cm. Incl. fittings.  
Capacity: 50-60 pcs.

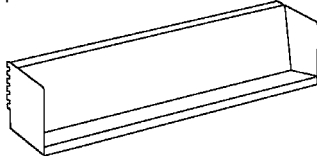

Item no.	Price DKK
B30515019	1.190

### Steel shelf for CD's - 5 compartments (W17.8) with 4 steel dividers

W90 x H15 x D22.5 cm. Incl. fittings.  
Capacity: 75 CD's

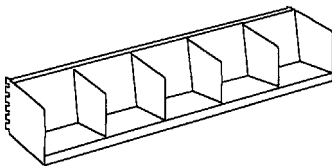

Item no.	Price DKK
B30513019	2.016

### Steel shelf - 4 compartments (W22.4 cm) with 3 steel dividers

W90 x H20 cm. Incl. fittings.  
Capacity: 75 picture books

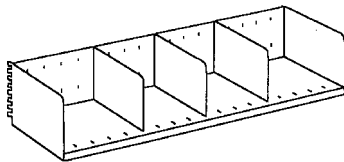

Depth  
cm  
22.5  
30

Item no.	Price DKK
B3050411	1.379
B3050413	1.559

### Extra steel dividers for steel shelf B305041x

H17.5 cm

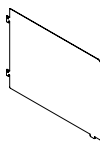

Depth  
cm  
22.5  
30

Item no.	Price DKK
B4010401	140
B4010403	163

### Steel shelf with 5 sliding dividers

W90 x H40 x D40 cm. Incl. fittings.  
Can be used under browsers with  
D40 cm on page 117. Capacity:  
75 picture books/ 100 music  
books.

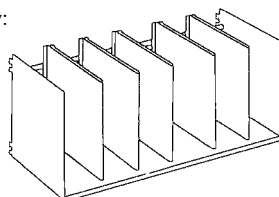

Item no.	Price DKK
B305080	4.383

# FUNCTIONS

## DISPLAY & STORAGE - FOR SHELVES

---

### Steel magazine display

H300 mm. With slanted back and additional side stop. A double front edge keeps this collector flush with the front edge of the shelf. With slip stop to prevent the display from slipping on steel shelves.

Size	Width mm
DIN A4	220
DIN A3	440

Item no.

B4055064  
B4055063

Price  
DKK

347  
597

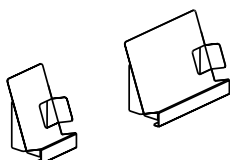

---

### Steel magazine divider

H300 x W95 x D240 mm. Single, slanted element connectable side by side via plug-in connections. For bay W700 mm, use 6 dividers. For bay W900 mm, use 8 dividers. For bay W1000 mm, use 9 dividers.

Size
DIN A4

Item no.

B405508

Price  
DKK

303

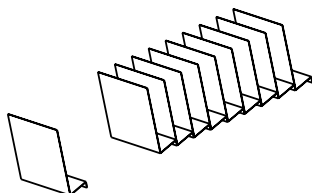

# FUNCTIONS

## DISPLAY & STORAGE - FOR SHELVES

---

### Steel U-storage

H250 x W145 x D220 mm.  
Multi-functional storage use.

Item no.

Price  
DKK

B405510

415

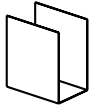

---

### Steel slanted CD tray

H120 x W150 x D220 mm. With anti-slipping feet. Rubber mat to be ordered separately.

Approx. capacity

Item no.

Price  
DKK

20 CD's  
Rubber mat

B405536

549

B405538

71

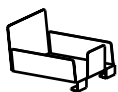

# ACCESSORIES

## DISPLAY & STORAGE - FOR WOODEN SLAT END PANEL

Acrylic media display holder

H100 x W600 x D40 mm.

Item no.

Price  
DKK

E34466

-

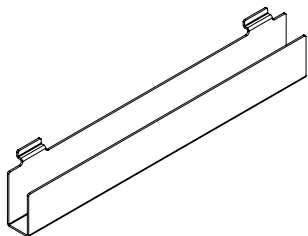

Acrylic brochure holder

H250 x W500 x D50 mm.

Item no.

Price  
DKK

E34467

-

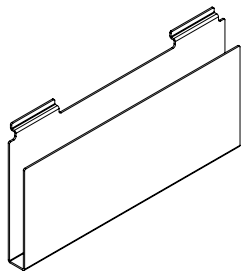

Acrylic sloping shelf display

H200 x W500 x D300 mm.

Item no.

Price  
DKK

E34468

-

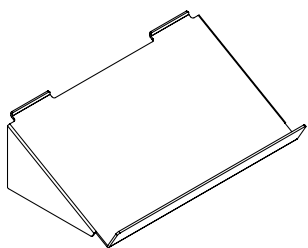

Acrylic tilted shelf display

H160 mm.

Width  
mm

Depth  
mm

Item no.

Price  
DKK

75  
220

90  
95

E34469

E34470

-

-

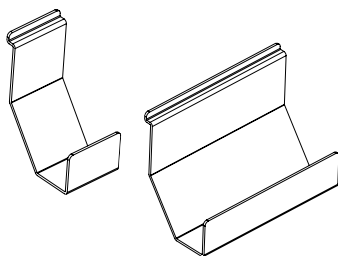



# ACCESSORIES

## DISPLAY & STORAGE - FOR PERFORATED STEEL END PANELS

### Steel CD and paperback holder

The holder is a pair, so the width will vary. Bright galvanized steel.

Height mm	Max. insert size mm	Item no.	Price DKK
60	25	B4055221	105
140	25	B4055222	110

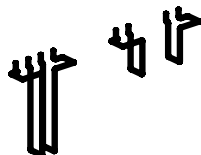

### Steel book presenter

H148 x W90 mm. Chromed steel.

Size	Max. insert size mm	Item no.	Price DKK
A4	45	B405526	115



### Steel hanging display

H200 x W90 mm. Chromed steel.

Size	Max. insert size mm	Item no.	Price DKK
A4	50	B405528	81





WE  
ARE  
LIBRARY  
PEOPLE®



# ACCESSORIES

## SIGNAGE - FOR END PANEL/UPRIGHT/TOP

### Steel sign for wooden end panel

Fastened to the end panel with screws.  
The sign has an acrylic film for insertion  
of textslide.

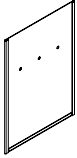

A4 vertical/upright format  
A3 vertical/upright format  
A3 horizontal format

Item no.	Price DKK
B40110377	276
B40110378	368
B40110379	368

### Steel sign for 60/30 Classic upright

For double-sided shelving. Fastened into  
the slots of the upright.

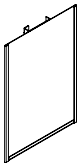

A4 vertical/upright format  
A3 vertical/upright format  
A4 horizontal format

Item no.	Price DKK
B40110337	276
B40110338	368
B40110339	368

### Laminated top sign for 60/30 Classic shelving bays

H150 x W870 mm (H290 mm when  
mounted). Only for module 90 cm. To  
be mounted in upper crossbar. Ideal  
for 60/30 Expo. Laminat available in  
white, black and grey.



Item no.	Price DKK
B3085039	2.284

# ACCESSORIES

## SIGNAGE - FOR SHELF

### Steel sign for wooden top shelf and London wooden overlaying top plate

H4,5 cm. White label to be ordered separately.	Module cm		Item no.	Price DKK
	75	Sign	B4010087	412
	90	Sign	B4010087	412
	100	Sign	B4010087	412
	100	Label	B40113002	36

### Magnetic shelf label - for steel top shelf with 47 mm frontedge

H40 mm. Black. Attach to steel shelves with smooth edge.	Width mm		Item no.	Price DKK
	300		B4000020300	85

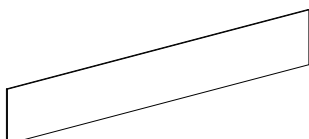

### Plastic clip-on label holder - for steel shelf S1 with 25 mm frontedge

H25 mm. Incl. white label. Can glide along shelf.	Width mm		Item no.	Price DKK
	220		B401135	74

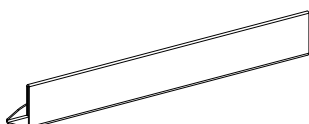

### Plastic clip-on label holder - for steel shelf S2 with 25 mm frontedge

H25 mm. Incl. white label. Can glide along shelf.	Width mm		Item no.	Price DKK
	213		E3881	-

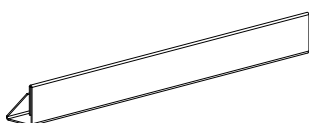

# ACCESSORIES

## SIGNAGE - FOR SHELF

### Self-adhesive plastic label holder - for steel shelf S1/S2 with 25 mm frontedge

H20 mm. Transparent, antireflective plastic. Incl. white label.	Width mm		Item no.	Price DKK
	147		B4017124	11
	200		B4017125	16

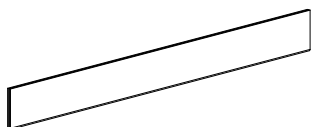

### Magnetic plastic label holder - for steel shelf S1/S2 with 25 mm frontedge

H20 mm. Transparent, antireflective plastic. Incl. white label. Attach to steel shelves with smooth edge.	Width mm		Item no.	Price DKK
	210	Self-adhesive plastic label holder	B4017147	87
	209	White sheet w. 13 labels (spare part)	B4017116	7

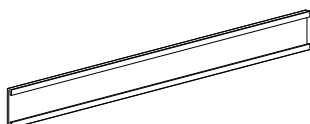

### Steel label holder

H26 x W150 x D150 mm. Lacquered steel with transparent, antireflective plastic. Incl. white label. Universal use, simply place on shelf where needed.		Item no.	Price DKK
		B401801	87

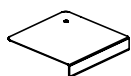

### Labelling cube

H200 x D200 mm. Acrylic glass. Inscription field with transparent cover on sloping front. Incl. white cardboard label. Universal use, place in between books on shelf where needed.	Width mm		Item no.	Price DKK
	120		B40552011	714
	200		B40552031	755
	120		B4055211	8
	200		B4055213	8

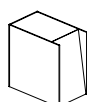

# UPRIGHTS

## 60/30 CLASSIC UPRIGHTS

### 60/30 uprights - height 92 cm

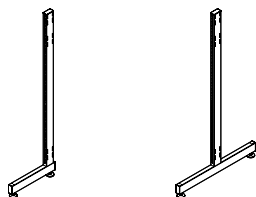

Shelf depth cm	Item no. Single-sided	Price DKK	Item no. Double-sided	Price DKK
22.5	B301000711	967	B301000712	1.055
25	B301000721	1.011	B301000722	1.083
30	B301000731	1.023	B301000732	1.125
40	B301000741	1.052	B301000742	1.170

### 60/30 Classic uprights - height 122 cm

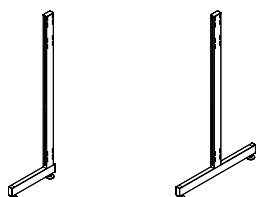

Shelf depth cm	Item no. Single-sided	Price DKK	Item no. Double-sided	Price DKK
22.5	B301000211	1.075	B301000212	1.174
25	B301000221	1.120	B301000222	1.206
30	B301000231	1.135	B301000232	1.253
40	B301000241	1.166	B301000242	1.296

### 60/30 Classic uprights - height 152 cm

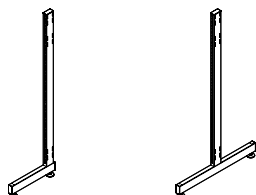

Shelf depth cm	Item no. Single-sided	Price DKK	Item no. Double-sided	Price DKK
22.5	B301000511	1.190	B301000512	1.312
25	B301000521	1.215	B301000522	1.341
30	B301000531	1.232	B301000532	1.371
40	B301000541	1.256	B301000542	1.445

### 60/30 Classic uprights - height 182 cm

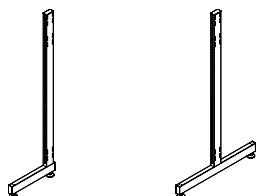

Shelf depth cm	Item no. Single-sided	Price DKK	Item no. Double-sided	Price DKK
22.5	B301000811	1.296	B301000812	1.371
25	B301000821	1.313	B301000822	1.432
30	B301000831	1.331	B301000832	1.472
40	B301000841	1.368	B301000842	1.543

### 60/30 Classic uprights - height 199.5 cm

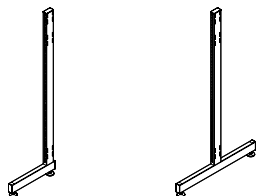

Shelf depth cm	Item no. Single-sided	Price DKK	Item no. Double-sided	Price DKK
22.5	B301000911	1.369	B301000912	1.493
25	B301000921	1.379	B301000922	1.521
30	B301000931	1.395	B301000932	1.543
40	B301000941	1.433	B301000942	1.606

### 60/30 Classic uprights - height 212 cm

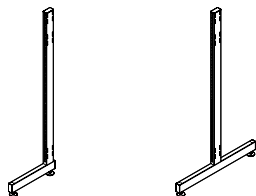

Shelf depth cm	Item no. Single-sided	Price DKK	Item no. Double-sided	Price DKK
22.5	B301000111	1.406	B301000112	1.529
25	B301000121	1.429	B301000122	1.550
30	B301000131	1.448	B301000132	1.565
40	B301000141	1.476	B301000142	1.635

# UPRIGHTS

## 80/30 CLASSIC UPRIGHTS

### 80/30 Classic uprights - height 199 cm

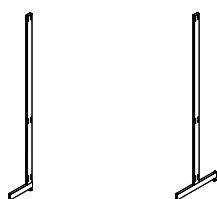

Shelf depth cm	Item no. Single-sided	Price DKK	Item no. Double-sided	Price DKK
22.5	B301060311	1.647	B301060312	1.817
25	B301060321	1.675	B301060322	1.939
30	B301060331	1.714	B301060332	1.913
40	B301060341	1.748	B301060342	2.047

### 80/30 Classic uprights - height 229 cm

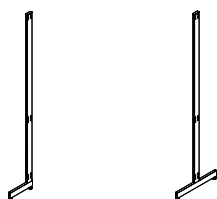

Shelf depth cm	Item no. Single-sided	Price DKK	Item no. Double-sided	Price DKK
22.5	B301060211	1.740	B301060212	1.914
25	B301060221	1.769	B301060222	1.939
30	B301060231	1.804	B301060232	1.994
40	B301060241	1.845	B301060242	2.137

### 80/30 Classic uprights - height 259 cm

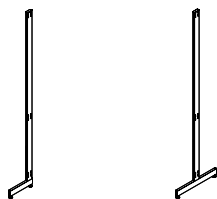

Shelf depth cm	Item no. Single-sided	Price DKK	Item no. Double-sided	Price DKK
22.5	B301060111	1.816	B301060112	1.997
25	B301060121	1.856	B301060122	2.040
30	B301060131	1.896	B301060132	2.093
40	B301060141	1.928	B301060142	2.230

# UPRIGHTS

## 60/30 CLASSIC WALL STRIPS

---

60/30 Classic wall strips



Height  
cm

112.5  
142.5  
172.5  
202.5

Item no.

B30105011  
B30105014  
B30105017  
B30105020

Price  
DKK

188  
243  
278  
316

---



# UPRIGHTS

## COMPONENTS FOR HIDDEN CASTOR ASSEMBLY ON 60/30 CLASSIC DOUBLE-SIDED SHELVING

### 60/30 Classic double-sided upright - height 92 cm

Only to be used with the wheel frame and castor set below. Adjustment of levelling glide makes the shelving non-moveable.

Shelf depth cm
22.5
25
30
40

Item no.	Price DKK
B30101671	1.266
B30101672	1.303
B30101673	1.352
B30101674	1.402



### 60/30 Classic double-sided upright - height 122 cm

Only to be used with the wheel frame and castor set below. Adjustment of levelling glide makes the shelving non-moveable.

Shelf depth cm
22.5
25
30
40

Item no.	Price DKK
B30101621	1.405
B30101622	1.446
B30101623	1.500
B30101624	1.557



### 60/30 Classic double-sided upright - height 152 cm

Only to be used with the wheel frame and castor set below. Adjustment of levelling glide makes the shelving non-moveable.

Shelf depth cm
22.5
25
30
40

Item no.	Price DKK
B30101651	1.571
B30101652	1.609
B30101653	1.644
B30101654	1.735



### Castor frame and castor set for 60/30 Classic double-sided upright

Fittings included. To hide castors, use plinth for 60/30 shelving, see page 139.

Module cm
75
90
100

Item no.	Price DKK
B3010187	3.468
B3010189	3.468
B3010181	3.724



# COMPONENTS

## UPRIGHT EXTENSIONS, CROSSBARS & ANTI-TOPPLE BRACKETS

### Upright extension

H30 x D6/D8 x W3 cm.

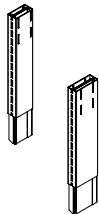

	Item no. 60/30	Price DKK	Item no. 80/30	Price DKK
Single-sided	B3011103061	401	B3011103081	478
Double-sided	B3011103062	421	B3011103082	498

### Crossbar

See technical specifications for amount of crossbars per unit.

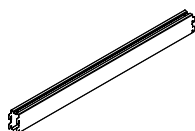

Module cm	Item no.	Price DKK
75	B3010127	458
90	B3010129	498
100	B3010121	542

### Anti-topple bracket

Secures single-sided bays to wall.

Item no.	Price DKK
B115507	-

# COMPONENTS

## PLINTHS & CASTORS

### Steel plinth for 60/30 Classic

H6 x top D3.2 cm. Including screws.

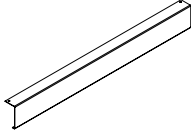

Module cm	Bays	Item no.	Price DKK
75	1	B302015701	215
75	2	B302015702	396
75	3	B302015703	512
90	1	B302015901	222
90	2	B302015902	399
100	1	B302015101	228
100	2	B302015102	419

### Steel plinth for 60/30 Classic - extra depth

H6 x top D13.2 cm. Including screws. To be used when magazine display B3051xx is placed furthest down.

Module cm	Bays	Item no.	Price DKK
75	1	B302025701	215
75	2	B302025702	396
75	3	B302025703	512
90	1	B302025901	222
90	2	B302025902	399
100	1	B302025101	228
100	2	B302025102	419

### Steel plinth for 80/30 Classic

H8 x top D3.2 cm. Including pins.

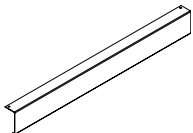

Module cm	Bays	Item no. 80/30	Price DKK
75	1	B3020167	167
90	1	B3020169	187
100	1	B3020161	242

### Castors

H9.9 cm.

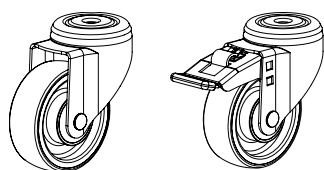

Brakes	Item no.	Price DKK
Without	B3060000	390
With	B3060001	543

# PANELS

## PAINTED WOODEN END PANELS

### Painted FSC wooden end panel - single-sided

19 mm front edge. Incl. fittings. These end panels are not compatible with 60/30 Classic wall steel shelving.



Height cm	Shelf depth cm	Item no. Left	Price DKK	Item no. Right	Price DKK
92	22.5	B3016657175	994	B3016657185	994
92	25	B3016657275	1.032	B3016657285	1.032
92	30	B3016657375	1.038	B3016657385	1.038
92	40	B3016657475	1.287	B3016657485	1.287
122	22.5	B3016652175	1.319	B3016652185	1.319
122	25	B3016652275	1.372	B3016652285	1.372
122	30	B3016652375	1.378	B3016652385	1.378
122	40	B3016652475	1.706	B3016652485	1.706
152	22.5	B3016655175	1.378	B3016655185	1.378
152	25	B3016655275	1.479	B3016655285	1.479
152	30	B3016655375	1.684	B3016655385	1.684
152	40	B3016655475	1.850	B3016655485	1.850
182	22.5	B3016658175	1.623	B3016658185	1.623
182	25	B3016658275	1.751	B3016658285	1.751
182	30	B3016658375	1.756	B3016658385	1.756
182	40	B3016658475	2.191	B3016658485	2.191
199.5	22.5	B3016659175	1.603	B3016659185	1.603
199.5	25	B3016659275	1.680	B3016659285	1.680
199.5	30	B3016659375	1.984	B3016659385	1.984
199.5	40	B3016659475	2.471	B3016659485	2.471
212	22.5	B3016651175	1.704	B3016651185	1.704
212	25	B3016651275	1.780	B3016651285	1.780
212	30	B3016651375	2.028	B3016651385	2.028
212	40	B3016651475	2.535	B3016651485	2.535

### Painted FSC wooden end panel - double-sided

19 mm front edge. Incl. fittings. These end panels are not compatible with hidden castor frames.

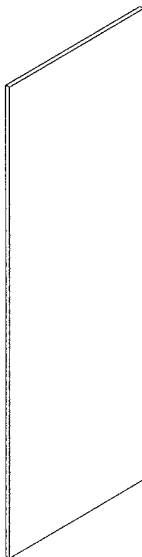

Height cm	Shelf depth cm	Item no.	Price DKK
92	22.5	B3016657195	1.322
92	25	B3016657295	1.431
92	30	B3016657395	1.652
92	40	B3016657495	2.088
122	22.5	B3016652195	1.755
122	25	B3016652295	1.898
122	30	B3016652395	2.190
122	40	B3016652495	2.769
152	22.5	B3016655195	2.126
152	25	B3016655295	2.312
152	30	B3016655395	2.668
152	40	B3016655495	3.396
182	22.5	B3016658195	2.504
182	25	B3016658295	2.719
182	30	B3016658395	3.155
182	40	B3016658495	4.026
199.5	22.5	B3016659195	2.805
199.5	25	B3016659295	3.059
199.5	30	B3016659395	3.553
199.5	40	B3016659495	4.535
212	22.5	B3016651195	2.874
212	25	B3016651295	3.133
212	30	B3016651395	3.642
212	40	B3016651495	4.654

# PANELS

## VENEER WOODEN END PANELS

### Veneer FSC wooden end panel - single-sided

19 mm front edge. Incl. fittings. These end panels are not compatible with 60/30 Classic wall steel shelving.



Height cm	Shelf depth cm	Item no. Left	Price DKK	Item no. Right	Price DKK
92	22.5	B3016657171	1.392	B3016657181	1.392
92	25	B3016657271	1.445	B3016657281	1.445
92	30	B3016657371	1.454	B3016657381	1.454
92	40	B3016657471	1.802	B3016657481	1.802
122	22.5	B3016652171	1.847	B3016652181	1.847
122	25	B3016652271	1.921	B3016652281	1.921
122	30	B3016652371	1.929	B3016652381	1.929
122	40	B3016652471	2.388	B3016652481	2.388
152	22.5	B3016655171	1.929	B3016655181	1.929
152	25	B3016655271	2.071	B3016655281	2.071
152	30	B3016655371	2.358	B3016655381	2.358
152	40	B3016655471	2.590	B3016655481	2.590
182	22.5	B3016658171	2.272	B3016658181	2.272
182	25	B3016658271	2.451	B3016658281	2.451
182	30	B3016658371	2.458	B3016658381	2.458
182	40	B3016658471	3.068	B3016658481	3.068
199.5	22.5	B3016659171	2.244	B3016659181	2.244
199.5	25	B3016659271	2.352	B3016659281	2.352
199.5	30	B3016659371	2.778	B3016659381	2.778
199.5	40	B3016659471	3.460	B3016659481	3.460
212	22.5	B3016651171	2.385	B3016651181	2.385
212	25	B3016651271	2.493	B3016651281	2.493
212	30	B3016651371	2.840	B3016651381	2.840
212	40	B3016651471	3.549	B3016651481	3.549

### Veneer FSC wooden end panel - double-sided

19 mm front edge. Incl. fittings. These end panels are not compatible with hidden castor frames.

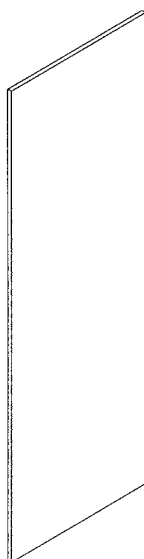

Height cm	Shelf depth cm	Item no.	Price DKK
92	22.5	B3016657191	1.851
92	25	B3016657291	2.003
92	30	B3016657391	2.313
92	40	B3016657491	2.923
122	22.5	B3016652191	2.457
122	25	B3016652291	2.658
122	30	B3016652391	3.067
122	40	B3016652491	3.876
152	22.5	B3016655191	2.976
152	25	B3016655291	3.237
152	30	B3016655391	3.735
152	40	B3016655491	4.754
182	22.5	B3016658191	3.506
182	25	B3016658291	3.807
182	30	B3016658391	4.417
182	40	B3016658491	5.637
199.5	22.5	B3016659191	3.928
199.5	25	B3016659291	4.282
199.5	30	B3016659391	4.974
199.5	40	B3016659491	6.348
212	22.5	B3016651191	4.024
212	25	B3016651291	4.387
212	30	B3016651391	5.099
212	40	B3016651491	6.515

# PANELS

## PAINTED WOODEN SLAT END PANELS

### Painted FSC wooden slat end panel - single-sided

22 mm front edge. Incl. fittings. These end panels are not compatible with 60/30 Classic wall steel shelving.

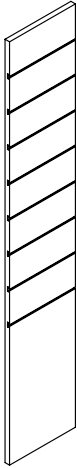

Height cm	Shelf depth cm	Item no. Left	Price DKK	Item no. Right	Price DKK
92	22.5	B3016747175	1.259	B3016747185	1.259
92	25	B3016747275	1.319	B3016747285	1.319
92	30	B3016747375	1.386	B3016747385	1.386
92	40	B3016747475	1.707	B3016747485	1.707
122	22.5	B3016742175	1.668	B3016742185	1.668
122	25	B3016742275	1.751	B3016742285	1.751
122	30	B3016742375	1.838	B3016742385	1.838
122	40	B3016742475	2.266	B3016742485	2.266
152	22.5	B3016745175	1.919	B3016745185	1.919
152	25	B3016745275	2.005	B3016745285	2.005
152	30	B3016745375	2.158	B3016745385	2.158
152	40	B3016745475	2.676	B3016745485	2.676
182	22.5	B3016748175	2.098	B3016748185	2.098
182	25	B3016748275	2.197	B3016748285	2.197
182	30	B3016748375	2.378	B3016748385	2.378
182	40	B3016748475	2.950	B3016748485	2.950
212	22.5	B3016741175	2.367	B3016741185	2.367
212	25	B3016741275	2.475	B3016741285	2.475
212	30	B3016741375	2.676	B3016741385	2.676
212	40	B3016741475	3.326	B3016741485	3.326

### Painted FSC wooden slat end panel - double-sided

22 mm front edge. Incl. fittings. These end panels are not compatible with hidden castor frames.

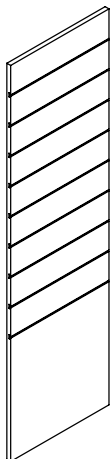

Height cm	Shelf depth cm	Item no.	Price DKK
92	22.5	B3016747195	2.108
92	25	B3016747295	2.216
92	30	B3016747395	2.315
92	40	B3016747495	2.369
122	22.5	B3016742195	2.798
122	25	B3016742295	2.939
122	30	B3016742395	3.069
122	40	B3016742495	3.142
152	22.5	B3016745195	3.220
152	25	B3016745295	3.350
152	30	B3016745395	3.614
152	40	B3016745495	3.701
182	22.5	B3016748195	3.517
182	25	B3016748295	3.678
182	30	B3016748395	3.982
182	40	B3016748495	4.072
212	22.5	B3016741195	3.957
212	25	B3016741295	4.138
212	30	B3016741395	4.477
212	40	B3016741495	4.580

# PANELS

## VENEER WOODEN SLAT END PANELS

### Veneer FSC wooden slat end panel - single-sided

22 mm front edge. Incl. fittings. These end panels are not compatible with 60/30 Classic wall steel shelving.

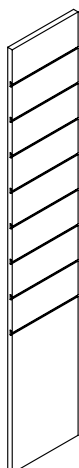

Height cm	Shelf depth cm	Item no. Left	Price DKK	Item no. Right	Price DKK
92	22.5	B3016747171	1.762	B3016747181	1.762
92	25	B3016747271	1.847	B3016747281	1.847
92	30	B3016747371	1.940	B3016747381	1.940
92	40	B3016747471	2.389	B3016747481	2.389
122	22.5	B3016742171	2.335	B3016742181	2.335
122	25	B3016742271	2.451	B3016742281	2.451
122	30	B3016742371	2.573	B3016742381	2.573
122	40	B3016742471	3.173	B3016742481	3.173
152	22.5	B3016745171	2.686	B3016745181	2.686
152	25	B3016745271	2.807	B3016745281	2.807
152	30	B3016745371	3.021	B3016745381	3.021
152	40	B3016745471	3.747	B3016745481	3.747
182	22.5	B3016748171	2.937	B3016748181	2.937
182	25	B3016748271	3.075	B3016748281	3.075
182	30	B3016748371	3.329	B3016748381	3.329
182	40	B3016748471	4.130	B3016748481	4.130
212	22.5	B3016741171	3.313	B3016741181	3.313
212	25	B3016741271	3.466	B3016741281	3.466
212	30	B3016741371	3.747	B3016741381	3.747
212	40	B3016741471	4.657	B3016741481	4.657

### Veneer FSC wooden slat end panel - double-sided

22 mm front edge. Incl. fittings. These end panels are not compatible with hidden castor frames.

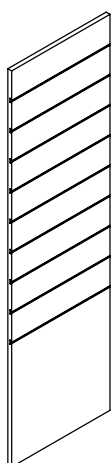

Height cm	Shelf depth cm	Item no.	Price DKK
92	22.5	B3016747191	2.952
92	25	B3016747291	3.102
92	30	B3016747391	3.242
92	40	B3016747491	3.316
122	22.5	B3016742191	3.918
122	25	B3016742291	4.114
122	30	B3016742391	4.296
122	40	B3016742491	4.398
152	22.5	B3016745191	4.507
152	25	B3016745291	4.690
152	30	B3016745391	5.060
152	40	B3016745491	5.182
182	22.5	B3016748191	4.923
182	25	B3016748291	5.149
182	30	B3016748391	5.575
182	40	B3016748491	5.701
212	22.5	B3016741191	5.539
212	25	B3016741291	5.793
212	30	B3016741391	6.268
212	40	B3016741491	6.412

# PANELS

## PAINTED LONDON WOODEN END PANELS - FOR STEEL TOP SHELF

### Painted FSC London wooden end panel for steel top shelf - single-sided

30 mm front edge. To be used with steel top shelf, see pages 76-95. Incl. fittings. These end panels are not compatible with 60/30 Classic Classic wall steel shelving.

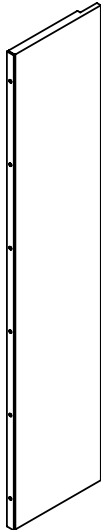

Height cm	Shelf depth cm	Item no. Left	Price DKK	Item no. Right	Price DKK
92	22.5	B3021257172	1.370	B3021257182	1.370
92	25	B3021257272	1.441	B3021257282	1.441
92	30	B3021257372	1.588	B3021257382	1.588
92	40	B3021257472	1.880	B3021257482	1.880
122	22.5	B3021252172	1.726	B3021252182	1.726
122	25	B3021252272	1.815	B3021252282	1.815
122	30	B3021252372	2.003	B3021252382	2.003
122	40	B3021252472	2.371	B3021252482	2.371
152	22.5	B3021255172	2.059	B3021255182	2.059
152	25	B3021255272	2.168	B3021255282	2.168
152	30	B3021255372	2.383	B3021255382	2.383
152	40	B3021255472	2.850	B3021255482	2.850
182	22.5	B3021258172	2.359	B3021258182	2.359
182	25	B3021258272	2.483	B3021258282	2.483
182	30	B3021258372	2.765	B3021258382	2.765
182	40	B3021258472	3.318	B3021258482	-
212	22.5	B3021251172	2.721	B3021251182	2.721
212	25	B3021251272	2.864	B3021251282	2.864
212	30	B3021251372	3.172	B3021251382	3.172
212	40	B3021251472	3.821	B3021251482	3.821

### Painted FSC London wooden end panel for steel top shelf - double-sided

30 mm front edge. To be used with steel top shelf, see pages 76-95. Incl. fittings.

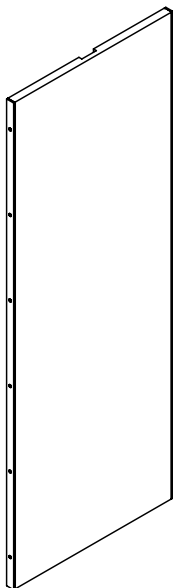

Height cm	Shelf depth cm	Item no.	Price DKK
92	22.5	B3021257192	2.478
92	25	B3021257292	2.609
92	30	B3021257392	2.901
92	40	B3021257492	3.488
122	22.5	B3021252192	3.130
122	25	B3021252292	3.294
122	30	B3021252392	3.662
122	40	B3021252492	4.404
152	22.5	B3021255192	3.706
152	25	B3021255292	3.901
152	30	B3021255392	4.362
152	40	B3021255492	5.289
182	22.5	B3021258192	4.285
182	25	B3021258292	4.511
182	30	B3021258392	5.064
182	40	B3021258492	6.168
212	22.5	B3021251192	4.922
212	25	B3021251292	5.181
212	30	B3021251392	5.824
212	40	B3021251492	7.116



# PANELS

## PAINTED LONDON WOODEN END PANELS - FOR LONDON OVERLAYING TOP PLATE

### Painted FSC London wooden end panel for wooden overlaying top plate - single-sided

30 mm front edge. To be used with London wooden overlaying top, see pages 106-111. Incl. fittings. These end panels are not compatible with 60/30 Classic wall steel shelving.

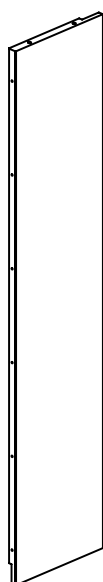

Height cm	Shelf depth cm	Item no. Left	Price DKK	Item no. Right	Price DKK
92	22.5	B3021257171	1.370	B3021257181	1.370
92	25	B3021257271	1.441	B3021257281	1.441
92	30	B3021257371	1.588	B3021257381	1.588
92	40	B3021257471	1.880	B3021257481	1.880
122	22.5	B3021252171	1.726	B3021252181	1.726
122	25	B3021252271	1.815	B3021252281	1.815
122	30	B3021252371	2.003	B3021252381	2.003
122	40	B3021252471	2.371	B3021252481	2.371
152	22.5	B3021255171	2.059	B3021255181	2.059
152	25	B3021255271	2.168	B3021255281	2.168
152	30	B3021255371	2.383	B3021255381	2.383
152	40	B3021255471	2.850	B3021255481	2.850
182	22.5	B3021258171	2.359	B3021258181	2.359
182	25	B3021258271	2.489	B3021258281	2.483
182	30	B3021258371	2.765	B3021258381	2.765
182	40	B3021258471	3.318	B3021258481	3.318
212	22.5	B3021251171	2.721	B3021251181	2.721
212	25	B3021251271	2.864	B3021251281	2.864
212	30	B3021251371	3.172	B3021251381	3.172
212	40	B3021251471	3.821	B3021251481	3.821

### Painted FSC London wooden end panel for wooden overlaying top plate - double-sided

30 mm front edge. To be used with London wooden overlaying top, see pages 106-111. Incl. fittings.

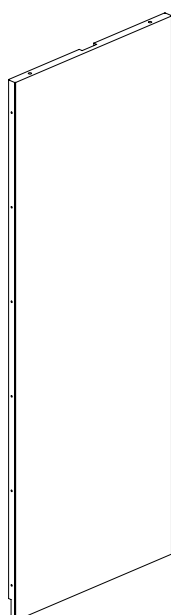

Height cm	Shelf depth cm	Item no.	Price DKK
92	22.5	B3021257191	2.478
92	25	B3021257291	2.609
92	30	B3021257391	2.901
92	40	B3021257491	3.488
122	22.5	B3021252191	3.130
122	25	B3021252291	3.294
122	30	B3021252391	3.662
122	40	B3021252491	4.404
152	22.5	B3021255191	3.706
152	25	B3021255291	3.901
152	30	B3021255391	4.362
152	40	B3021255491	5.289
182	22.5	B3021258191	4.285
182	25	B3021258291	4.511
182	30	B3021258391	5.064
182	40	B3021258491	6.168
212	22.5	B3021251191	4.922
212	25	B3021251291	5.181
212	30	B3021251391	5.824
212	40	B3021251491	7.116

# PANELS

## PERFORATED STEEL END PANEL

### Perforated steel end panels - single-sided

45 mm frontedge. One A5 acrylic cover for signage and fittings are included. Hole size Ø4,5 mm. These end panels are not compatible with 60/30 Classic wall steel shelving.

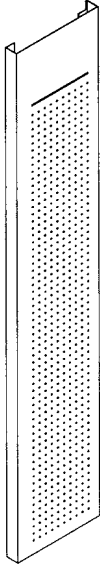

Height cm	Shelf depth cm	Item no. Left	Price DKK	Item no. Right	Price DKK
92	22.5	B301600717	1.069	B301600718	1.069
92	25	B301600727	1.102	B301600728	1.102
92	30	B301600737	1.154	B301600738	1.154
92	40	B301600747	1.266	B301600748	1.266
122	22.5	B301600217	1.124	B301600218	1.124
122	25	B301600227	1.161	B301600228	1.161
122	30	B301600237	1.217	B301600238	1.217
122	40	B301600247	1.331	B301600248	1.331
152	22.5	B301600517	1.430	B301600518	1.430
152	25	B301600527	1.469	B301600528	1.469
152	30	B301600537	1.523	B301600538	1.523
152	40	B301600547	1.642	B301600548	1.642
182	22.5	B301600817	1.590	B301600818	1.590
182	25	B301600827	1.627	B301600828	1.627
182	30	B301600837	1.698	B301600838	1.698
182	40	B301600847	1.831	B301600848	1.831
199.5	22.5	B301600917	1.693	B301600918	1.693
199.5	25	B301600927	1.722	B301600928	1.722
199.5	30	B301600937	1.804	B301600938	1.804
199.5	40	B301600947	1.944	B301600948	1.944
212	22.5	B301600117	1.763	B301600118	1.763
212	25	B301600127	1.804	B301600128	1.804
212	30	B301600137	1.877	B301600138	1.877
212	40	B301600147	2.027	B301600148	2.027

### Perforated steel end panels - double-sided

45 mm frontedge. Two A5 acrylic covers for signage and fittings are included. Hole size Ø4,5 mm

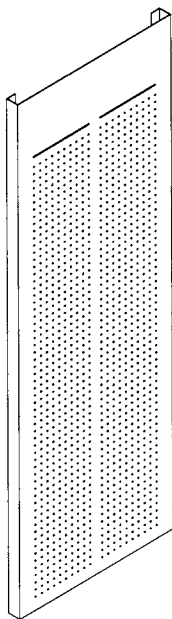

Height cm	Shelf depth cm	Item no.	Price DKK
92	22.5	B301600719	1.469
92	25	B301600729	1.521
92	30	B301600739	1.635
92	40	B301600749	1.857
122	22.5	B301600219	1.547
122	25	B301600229	1.604
122	30	B301600239	1.719
122	40	B301600249	1.954
152	22.5	B301600519	1.944
152	25	B301600529	2.027
152	30	B301600539	2.175
152	40	B301600549	2.473
182	22.5	B301600819	2.186
182	25	B301600829	2.279
182	30	B301600839	2.449
182	40	B301600849	2.807
199.5	22.5	B301600919	2.342
199.5	25	B301600929	2.437
199.5	30	B301600939	2.621
199.5	40	B301600949	3.000
212	22.5	B301600119	2.440
212	25	B301600129	2.533
212	30	B301600139	2.737
212	40	B301600149	3.137

# PANELS

## LONDON STEEL END PANELS - FOR LONDON STEEL OVERLAYING TOP PLATE

### London steel end panel for London steel overlaying top plate - single-sided

30 mm front edge. To be used with London steel overlaying top plate, see page 98-99. Incl. fittings. These end panels are not compatible with 60/30 Classic wall steel shelving.

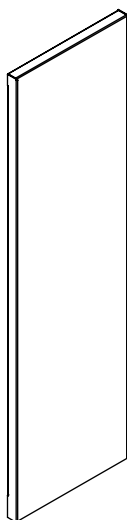

Height cm	Shelf depth cm	Item no. Left	Price DKK	Item no. Right	Price DKK
92	22.5	B30162071730	1.298	B30162071830	1.298
92	25	B30162072730	1.368	B30162072830	1.368
92	30	B30162073730	1.506	B30162073830	1.506
92	40	B30162074730	1.782	B30162074830	1.782
122	22.5	B30162012730	2.853	B30162021830	1.721
122	25	B30162022730	1.812	B30162022830	1.812
122	30	B30162023730	1.994	B30162023830	1.994
122	40	B30162024730	2.363	B30162024830	2.363
152	22.5	B30162051730	2.050	B30162051830	2.050
152	25	B30162052730	2.160	B30162052830	2.160
152	30	B30162053730	2.370	B30162053830	2.370
152	40	B30162054730	2.833	B30162054830	2.833
182	22.5	B30162081730	2.350	B30162081830	2.350
182	25	B30162082730	2.473	B30162082830	2.473
182	30	B30162083730	2.753	B30162083830	2.753
182	40	B30162084730	3.306	B30162084830	3.306
212	22.5	B30162011730	2.709	B30162011830	2.709
212	25	B30162012730	2.853	B30162012830	2.853
212	30	B30162013730	3.160	B30162013830	3.160
212	40	B30162014730	3.805	B30162014830	3.805

### London steel end panel for London steel overlaying top plate - double-sided

30 mm front edge. To be used with London steel overlaying top plate, see page 100-101. Incl. fittings.

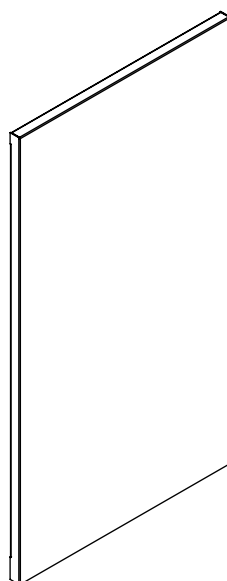

Height cm	Shelf depth cm	Item no.	Price DKK
92	22.5	B30162071930	2.350
92	25	B30162072930	2.473
92	30	B30162073930	2.750
92	40	B30162074930	3.307
122	22.5	B30162021930	3.117
122	25	B30162022930	3.279
122	30	B30162023930	3.649
122	40	B30162024930	4.386
152	22.5	B30162051930	3.692
152	25	B30162052930	3.886
152	30	B30162053930	4.345
152	40	B30162054930	5.264
182	22.5	B30162081930	4.265
182	25	B30162082930	4.490
182	30	B30162083930	5.044
182	40	B30162084930	6.147
212	22.5	B30162011930	4.895
212	25	B30162012930	5.154
212	30	B30162013930	5.799
212	40	B30162014930	7.084

# PANELS

## GLASS END PANELS

### Glass end panel - single-sided

10 mm front edge. Incl. fittings. These end panels are not compatible with 60/30 Classic wall steel shelving.

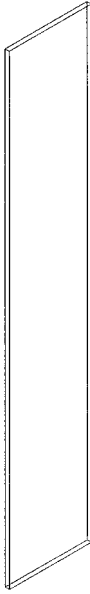

Height cm	Shelf depth cm	Item no. Left	Price DKK	Item no. Right	Price DKK
92	22.5	B301647771	2.080	B301647871	2.080
92	25	B301647772	2.370	B301647872	2.370
92	30	B301647773	2.618	B301647873	2.618
92	40	B301647774	3.661	B301647874	3.661
122	22.5	B301647721	2.187	B301647821	2.187
122	25	B301647722	2.496	B301647822	2.496
122	30	B301647723	2.754	B301647823	2.754
122	40	B301647724	3.852	B301647824	3.852
152	22.5	B301647751	2.740	B301647851	2.740
152	25	B301647752	3.019	B301647852	3.019
152	30	B301647753	3.442	B301647853	3.442
152	40	B301647754	4.891	B301647854	4.891
182	22.5	B301647781	3.287	B301647881	3.287
182	25	B301647782	3.442	B301647882	3.442
182	30	B301647783	3.954	B301647883	3.954
182	40	B301647784	5.475	B301647884	5.475
199.5	22.5	B301647791	3.614	B301647891	3.614
199.5	25	B301647792	3.770	B301647892	3.770
199.5	30	B301647793	4.277	B301647893	4.277
199.5	40	B301647794	5.798	B301647894	5.798
212	22.5	B301647711	3.844	B301647811	3.844
212	25	B301647712	3.860	B301647812	3.860
212	30	B301647713	4.298	B301647813	4.298
212	40	B301647714	6.246	B301647814	6.246

### Glass end panel - double-sided

10 mm front edge. Incl. fittings.

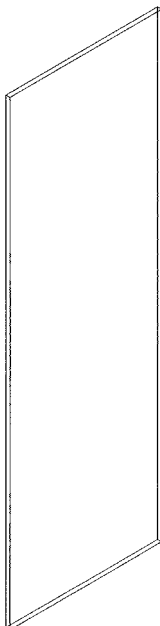

Height cm	Shelf depth cm	Item no.	Price DKK
92	22.5	B301647971	3.598
92	25	B301647972	3.662
92	30	B301647973	4.233
92	40	B301647974	4.798
122	22.5	B301647921	3.785
122	25	B301647922	3.853
122	30	B301647923	4.454
122	40	B301647924	5.051
152	22.5	B301647951	4.739
152	25	B301647952	4.891
152	30	B301647953	5.653
152	40	B301647954	6.420
182	22.5	B301647981	5.695
182	25	B301647982	5.475
182	30	B301647983	6.331
182	40	B301647984	7.194
199.5	22.5	B301647991	6.251
199.5	25	B301647992	6.858
199.5	30	B301647993	8.077
199.5	40	B301647994	6.305
212	22.5	B301647911	6.649
212	25	B301647912	6.246
212	30	B301647913	7.262
212	40	B301647914	8.280

# PANELS

## WOODEN BACK PANELS

### FSC wooden back panel

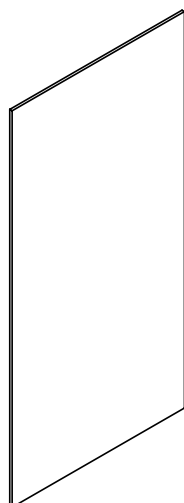

Height cm	Module cm	Item no. Painted	Price DKK	Item no. Veneer	Price DKK
92	75	B301902775	1.139	B301902771	1.594
92	90	B301902795	1.377	B301902791	1.927
92	100	B301902715	1.542	B301902711	2.158
122	75	B301902275	1.265	B301902271	1.771
122	90	B301902295	1.530	B301902291	2.142
122	100	B301902215	1.711	B301902211	2.395
152	75	B301902575	1.676	B301902571	2.346
152	90	B301902595	2.021	B301902591	2.830
152	100	B301902515	2.266	B301902511	3.173
182	75	B301902875	2.081	B301902871	2.913
182	90	B301902895	2.515	B301902891	3.521
182	100	B301902815	2.820	B301902811	3.948
199.5	75	B301902975	2.319	B301902971	3.246
199.5	90	B301902995	2.804	B301902991	3.926
199.5	100	B301902915	3.144	B301902911	4.401
212	75	B301902175	2.491	B301902171	3.487
212	90	B301902195	3.015	B301902191	4.220
212	100	B301902115	3.379	B301902111	4.731

### Fittings for wooden end panel

Type	Item no. Heights < 152 cm	Price DKK	Item no. Heights > =152 cm	Price DKK
Left	B30165227	179	B30165217	250
Right	B30165228	179	B30165218	250
Double	B30165229	356	B30165219	491

### Fittings for wooden display end panel

Type	Item no. Heights < 152 cm	Price DKK	Item no. Heights > =152 cm	Price DKK
Left	B30167227	179	B30167217	250
Right	B30167228	179	B30167218	250
Double	B30167229	356	B30167219	491

### Fittings for glass end panel

Type	Item no.	Price DKK
Left	B3016487	1.309
Right	B3016488	1.309
Double	B3016489	866



# END PANEL BAYS

FOR DOUBLE-SIDED 60/30 CLASSIC STEEL SHELVING

The following pages will show basic configurations of end panel bays for double-sided 60/30 Classic Steel Shelving system.



# END PANEL BAYS

## FOR DOUBLE-SIDED SHELVING WITH ADJUSTABLE FEET

FSC-approved end panel bay with wooden top shelf, wooden panels, wooden bottom shelf and adjustable feet. For shelves, see page 158.

### Height 92 cm

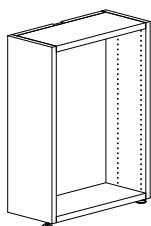

Depth of shelving system - cm	Width of end panel bay - cm	Depth of end panel bay - cm	Item no. Painted	Price DKK	Item no. Veneer	Price DKK
22,5/22,5	46,8	25	BB30130706005	8.525	BB30130706001	11.935
25/25	51,8	25	BB30130714005	8.525	BB30130714001	11.935
30/30	61,8	25	BB30130722005	9.550	BB30130722001	13.370
40/40	81,8	25	BB30130730005	10.914	BB30130730001	15.280
22,5/22,5	46,8	30	BB30130707005	8.525	BB30130707001	11.935
25/25	51,8	30	BB30130715005	8.525	BB30130715001	11.935
30/30	61,8	30	BB30130723005	9.550	BB30130723001	13.370
40/40	81,8	30	BB30130731005	10.914	BB30130731001	15.280

### Height 122

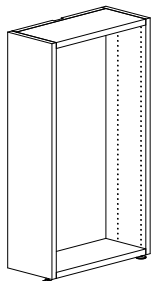

Depth of shelving system - cm	Width of end panel bay - cm	Depth of end panel bay - cm	Item no. Painted	Price DKK	Item no. Veneer	Price DKK
22,5/22,5	46,8	25	BB30130206005	11.176	BB30130206001	15.646
25/25	51,8	25	BB30130214005	11.176	BB30130214001	15.646
30/30	61,8	25	BB30130222005	12.536	BB30130222001	17.550
40/40	81,8	25	BB30130230005	14.344	BB30130230001	20.082
22,5/22,5	46,8	30	BB30130207005	11.176	BB30130207001	15.646
25/25	51,8	30	BB30130215005	11.176	BB30130215001	15.646
30/30	61,8	30	BB30130223005	12.536	BB30130223001	17.550
40/40	81,8	30	BB30130231005	14.344	BB30130231001	20.082

### Height 152 cm

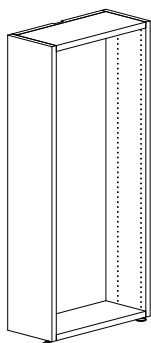

Depth of shelving system - cm	Width of end panel bay - cm	Depth of end panel bay - cm	Item no. Painted	Price DKK	Item no. Veneer	Price DKK
22,5/22,5	46,8	25	BB30130506005	13.824	BB30130506001	19.354
25/25	51,8	25	BB30130514005	13.824	BB30130514001	19.354
30/30	61,8	25	BB30130522005	15.517	BB30130522001	21.724
40/40	81,8	25	BB30130530005	17.773	BB30130530001	24.882
22,5/22,5	46,8	30	BB30130507005	13.824	BB30130507001	19.354
25/25	51,8	30	BB30130515005	13.824	BB30130515001	19.354
30/30	61,8	30	BB30130523005	15.517	BB30130523001	21.724
40/40	81,8	30	BB30130531005	17.773	BB30130531001	24.882



# END PANEL BAYS

FOR DOUBLE-SIDED SHELVING WITH ADJUSTABLE FEET

FSC-approved end panel bay with wooden top shelf, wooden panels, wooden bottom shelf and adjustable feet. For shelves, see page 158.

## Height 182 cm

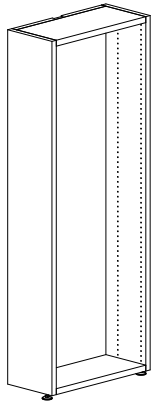

Depth of shelving system - cm	Width of end panel bay - cm	Depth of end panel bay - cm	Item no. Painted	Price DKK	Item no. Veneer	Price DKK
22,5/22,5	46,8	25	BB30130806005	16.474	BB30130806001	23.064
25/25	51,8	25	BB30130814005	16.474	BB30130814001	23.064
30/30	61,8	25	BB30130822005	18.503	BB30130822001	25.904
40/40	81,8	25	BB30130830005	21.200	BB30130830001	29.680
22,5/22,5	46,8	30	BB30130807005	16.474	BB30130807001	23.064
25/25	51,8	30	BB30130815005	16.474	BB30130815001	23.064
30/30	61,8	30	BB30130823005	18.503	BB30130823001	25.904
40/40	81,8	30	BB30130831005	21.200	BB30130831001	29.680

## Height 212 cm

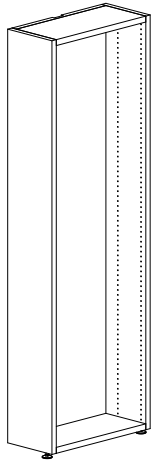

Depth of shelving system - cm	Width of end panel bay - cm	Depth of end panel bay - cm	Item no. Painted	Price DKK	Item no. Veneer	Price DKK
22,5/22,5	46,8	25	BB30130106005	19.124	BB30130106001	26.774
25/25	51,8	25	BB30130114005	19.124	BB30130114001	26.774
30/30	61,8	25	BB30130122005	21.484	BB30130122001	30.078
40/40	81,8	25	BB30130130005	24.631	BB30130130001	34.483
22,5/22,5	46,8	30	BB30130107005	19.124	BB30130107001	26.774
25/25	51,8	30	BB30130115005	19.124	BB30130115001	26.774
30/30	61,8	30	BB30130123005	21.484	BB30130123001	30.078
40/40	81,8	30	BB30130131005	24.631	BB30130131001	34.483

# END PANEL BAYS

FOR DOUBLE-SIDED SHELVING WITH AJDUSTABLE FEET & LONDON WOODEN TOP PLATE

FSC-approved end panel bay with overlaying London wooden top plate, wooden panels, wooden bottom shelf and adjustable feet. For shelves, see page 158.

## Height 92 cm

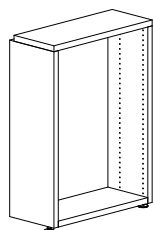

Depth of shelving system - cm	Width of end panel bay - cm	Depth of end panel bay - cm	Item no. Painted	Price DKK	Item no. Veneer	Price DKK
22,5/22,5	46,8	25	BB30131706005	8.525	BB30131706001	11.935
25/25	51,8	25	BB30131714005	8.525	BB30131714001	11.935
30/30	61,8	25	BB30131722005	9.550	BB30131722001	13.370
40/40	81,8	25	BB30131730005	10.914	BB30131730001	15.280
22,5/22,5	46,8	30	BB30131707005	8.525	BB30131707001	11.935
25/25	51,8	30	BB30131715005	8.525	BB30131715001	11.935
30/30	61,8	30	BB30131723005	9.550	BB30131723001	13.370
40/40	81,8	30	BB30131731005	10.914	BB30131731001	15.280

## Height 122

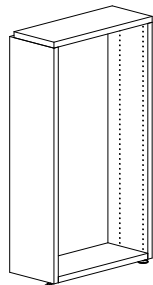

Depth of shelving system - cm	Width of end panel bay - cm	Depth of end panel bay - cm	Item no. Painted	Price DKK	Item no. Veneer	Price DKK
22,5/22,5	46,8	25	BB30131206005	11.176	BB30131206001	15.646
25/25	51,8	25	BB30131214005	11.176	BB30131214001	15.646
30/30	61,8	25	BB30131222005	12.536	BB30131222001	17.550
40/40	81,8	25	BB30131230005	14.344	BB30131230001	20.082
22,5/22,5	46,8	30	BB30131207005	11.176	BB30131207001	15.646
25/25	51,8	30	BB30131215005	11.176	BB30131215001	15.646
30/30	61,8	30	BB30131223005	12.536	BB30131223001	17.550
40/40	81,8	30	BB30131231005	14.344	BB30131231001	20.082

## Height 152 cm

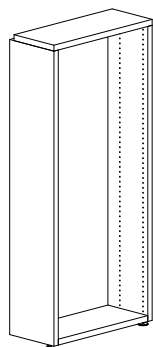

Depth of shelving system - cm	Width of end panel bay - cm	Depth of end panel bay - cm	Item no. Painted	Price DKK	Item no. Veneer	Price DKK
22,5/22,5	46,8	25	BB30131506005	13.824	BB30131506001	19.354
25/25	51,8	25	BB30131514005	13.824	BB30131514001	19.354
30/30	61,8	25	BB30131522005	15.517	BB30131522001	21.724
40/40	81,8	25	BB30131530005	17.773	BB30131530001	24.882
22,5/22,5	46,8	30	BB30131507005	13.824	BB30131507001	19.354
25/25	51,8	30	BB30131515005	13.824	BB30131515001	19.354
30/30	61,8	30	BB30131523005	15.517	BB30131523001	21.724
40/40	81,8	30	BB30131531005	17.773	BB30131531001	24.882

# END PANEL BAYS

FOR DOUBLE-SIDED SHELVING WITH ADJUSTABLE FEET & LONDON WOODEN TOP PLATE

FSC-approved end panel bay with overlaying London wooden top plate, wooden panels, wooden bottom shelf and adjustable feet. For shelves, see page 158.

## Height 182 cm

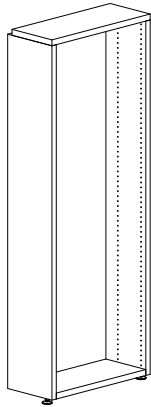

Depth of shelving system - cm	Width of end panel bay - cm	Depth of end panel bay - cm	Item no. Painted	Price DKK	Item no. Veneer	Price DKK
22,5/22,5	46,8	25	BB30131806005	16.474	BB30131806001	23.064
25/25	51,8	25	BB30131814005	16.474	BB30131814001	23.064
30/30	61,8	25	BB30131822005	18.503	BB30131822001	25.904
40/40	81,8	25	BB30131830005	21.200	BB30131830001	29.680
22,5/22,5	46,8	30	BB30131807005	16.474	BB30131807001	23.064
25/25	51,8	30	BB30131815005	16.474	BB30131815001	23.064
30/30	61,8	30	BB30131823005	18.503	BB30131823001	25.904
40/40	81,8	30	BB30131831005	21.200	BB30131831001	29.680

## Height 212 cm

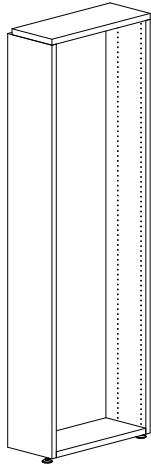

Depth of shelving system - cm	Width of end panel bay - cm	Depth of end panel bay - cm	Item no. Painted	Price DKK	Item no. Veneer	Price DKK
22,5/22,5	46,8	25	BB30131106005	19.124	BB30131106001	26.774
25/25	51,8	25	BB30131114005	19.124	BB30131114001	26.774
30/30	61,8	25	BB30131122005	21.484	BB30131122001	30.078
40/40	81,8	25	BB30131130005	24.631	BB30131130001	34.483
22,5/22,5	46,8	30	BB30131107005	19.124	BB30131107001	26.774
25/25	51,8	30	BB30131115005	19.124	BB30131115001	26.774
30/30	61,8	30	BB30131123005	21.484	BB30131123001	30.078
40/40	81,8	30	BB30131131005	24.631	BB30131131001	34.483

# END PANEL BAYS

## FOR DOUBLE-SIDED SHELVING WITH CASTORS

FSC-approved end panel bay with wooden top shelf, wooden panels, wooden bottom shelf and castors. For shelves, see page 158.

### Height 92 cm

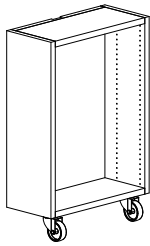

Depth of shelving system - cm	Width of end panel bay - cm	Depth of end panel bay - cm	Item no. Painted	Price DKK	Item no. Veneer	Price DKK
22,5/22,5	46,8	25	BB30134706005	9.305	BB30134706001	13.027
25/25	51,8	25	BB30134714005	9.305	BB30134714001	13.027
30/30	61,8	25	BB30134722005	10.330	BB30134722001	14.462
40/40	81,8	25	BB30134730005	11.694	BB30134730001	16.372
22,5/22,5	46,8	30	BB30134707005	9.305	BB30134707001	13.027
25/25	51,8	30	BB30134715005	9.305	BB30134715001	13.027
30/30	61,8	30	BB30134723005	10.330	BB30134723001	14.462
40/40	81,8	30	BB30134731005	11.694	BB30134731001	16.372

### Height 122

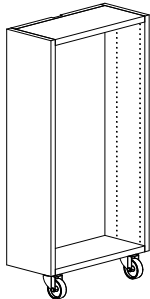

Depth of shelving system - cm	Width of end panel bay - cm	Depth of end panel bay - cm	Item no. Painted	Price DKK	Item no. Veneer	Price DKK
22,5/22,5	46,8	25	BB30134206005	11.956	BB30134206001	16.738
25/25	51,8	25	BB30134214005	11.956	BB30134214001	16.738
30/30	61,8	25	BB30134222005	13.316	BB30134222001	18.642
40/40	81,8	25	BB30134230005	15.124	BB30134230001	21.174
22,5/22,5	46,8	30	BB30134207005	11.956	BB30134207001	16.738
25/25	51,8	30	BB30134215005	11.956	BB30134215001	16.738
30/30	61,8	30	BB30134223005	13.316	BB30134223001	18.642
40/40	81,8	30	BB30134231005	15.124	BB30134231001	21.174

### Height 152 cm

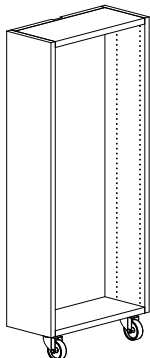

Depth of shelving system - cm	Width of end panel bay - cm	Depth of end panel bay - cm	Item no. Painted	Price DKK	Item no. Veneer	Price DKK
22,5/22,5	46,8	25	BB30134506005	14.604	BB30134506001	20.446
25/25	51,8	25	BB30134514005	14.604	BB30134514001	20.446
30/30	61,8	25	BB30134522005	16.297	BB30134522001	22.816
40/40	81,8	25	BB30134530005	18.553	BB30134530001	25.974
22,5/22,5	46,8	30	BB30134507005	14.604	BB30134507001	20.446
25/25	51,8	30	BB30134515005	14.604	BB30134515001	20.446
30/30	61,8	30	BB30134523005	16.297	BB30134523001	22.816
40/40	81,8	30	BB30134531005	18.553	BB30134531001	25.974

# END PANEL BAYS

FOR DOUBLE-SIDED SHELVING WITH CASTORS & LONDON WOODEN TOP PLATE

FSC-approved end panel bay with overlaying London wooden top plate, wooden panels, wooden bottom shelf and castors. For shelves, see page 158.

## Height 92 cm

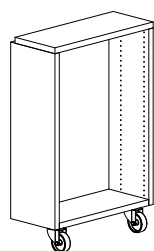

Depth of shelving system - cm	Width of end panel bay - cm	Depth of end panel bay - cm	Item no. Painted	Price DKK	Item no. Veneer	Price DKK
22,5/22,5	46,8	25	BB30135706005	9.305	BB30135706001	13.027
25/25	51,8	25	BB30135714005	9.305	BB30135714001	13.027
30/30	61,8	25	BB30135722005	10.330	BB30135722001	14.462
40/40	81,8	25	BB30135730005	11.694	BB30135730001	16.372
22,5/22,5	46,8	30	BB30135707005	9.305	BB30135707001	13.027
25/25	51,8	30	BB30135715005	9.305	BB30135715001	13.027
30/30	61,8	30	BB30135723005	10.330	BB30135723001	14.462
40/40	81,8	30	BB30135731005	11.694	BB30135731001	16.372

## Height 122

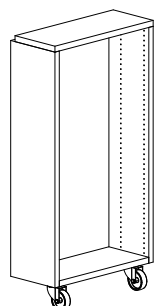

Depth of shelving system - cm	Width of end panel bay - cm	Depth of end panel bay - cm	Item no. Painted	Price DKK	Item no. Veneer	Price DKK
22,5/22,5	46,8	25	BB30135206005	11.956	BB30135206001	16.738
25/25	51,8	25	BB30135214005	11.956	BB30135214001	16.738
30/30	61,8	25	BB30135222005	13.316	BB30135222001	18.642
40/40	81,8	25	BB30135230005	15.124	BB30135230001	21.174
22,5/22,5	46,8	30	BB30135207005	11.956	BB30135207001	16.738
25/25	51,8	30	BB30135215005	11.956	BB30135215001	16.738
30/30	61,8	30	BB30135223005	13.316	BB30135223001	18.642
40/40	81,8	30	BB30135231005	15.124	BB30135231001	21.174

## Height 152 cm

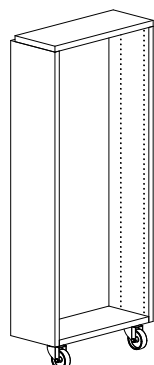

Depth of shelving system - cm	Width of end panel bay - cm	Depth of end panel bay - cm	Item no. Painted	Price DKK	Item no. Veneer	Price DKK
22,5/22,5	46,8	25	BB30135506005	14.604	BB30135506001	20.446
25/25	51,8	25	BB30135514005	14.604	BB30135514001	20.446
30/30	61,8	25	BB30135522005	16.297	BB30135522001	22.816
40/40	81,8	25	BB30135530005	18.553	BB30135530001	25.974
22,5/22,5	46,8	30	BB30135507005	14.604	BB30135507001	20.446
25/25	51,8	30	BB30135515005	14.604	BB30135515001	20.446
30/30	61,8	30	BB30135523005	16.297	BB30135523001	22.816
40/40	81,8	30	BB30135531005	18.553	BB30135531001	25.974

# END PANEL BAYS

## STEEL SHELVES

### Steel shelf with steel backedge for backedge book support

Steel backedge 47 mm.  
Brackets must be ordered  
separately.

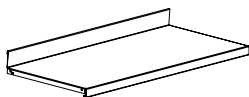

Depth of shelving system - cm	Depth of end panel bay - cm	Width of shelf - cm	Item no.	Price DKK
22,5/22,5	25	46,3	B30118206	528
25/25	25	51,3	B30118214	528
30/30	25	61,3	B30118222	580
40/40	25	71,3	B30118230	580
22,5/22,5	30	46,3	B30118207	528
25/25	30	51,3	B30118215	528
30/30	30	61,3	B30118223	580
40/40	30	71,3	B30118231	580

### Bracket for steel shelves with steel backedge

\* Can be used for D25 and  
30 cm shelves.

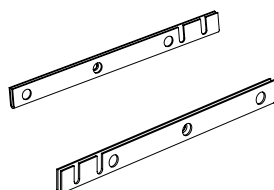

Type	Depth of end panel bay - cm	Item no.	Price DKK
Left	25	B78300128	134
Right	25	B78300129	134
Left*	30	B78300138	134
Right*	30	B78300139	134

### 45°/60° sloping steel shelf

With fittings.



Depth of shelving system - cm	Depth of end panel bay - cm	Item no.	Price DKK
22,5/22,5	25	B30118606	483
25/25	25	B30118614	483
30/30	25	B30118622	551
40/40	25	B30118630	551
22,5/22,5	30	B30118607	483
25/25	30	B30118615	483
30/30	30	B30118623	551
40/40	30	B30118631	551



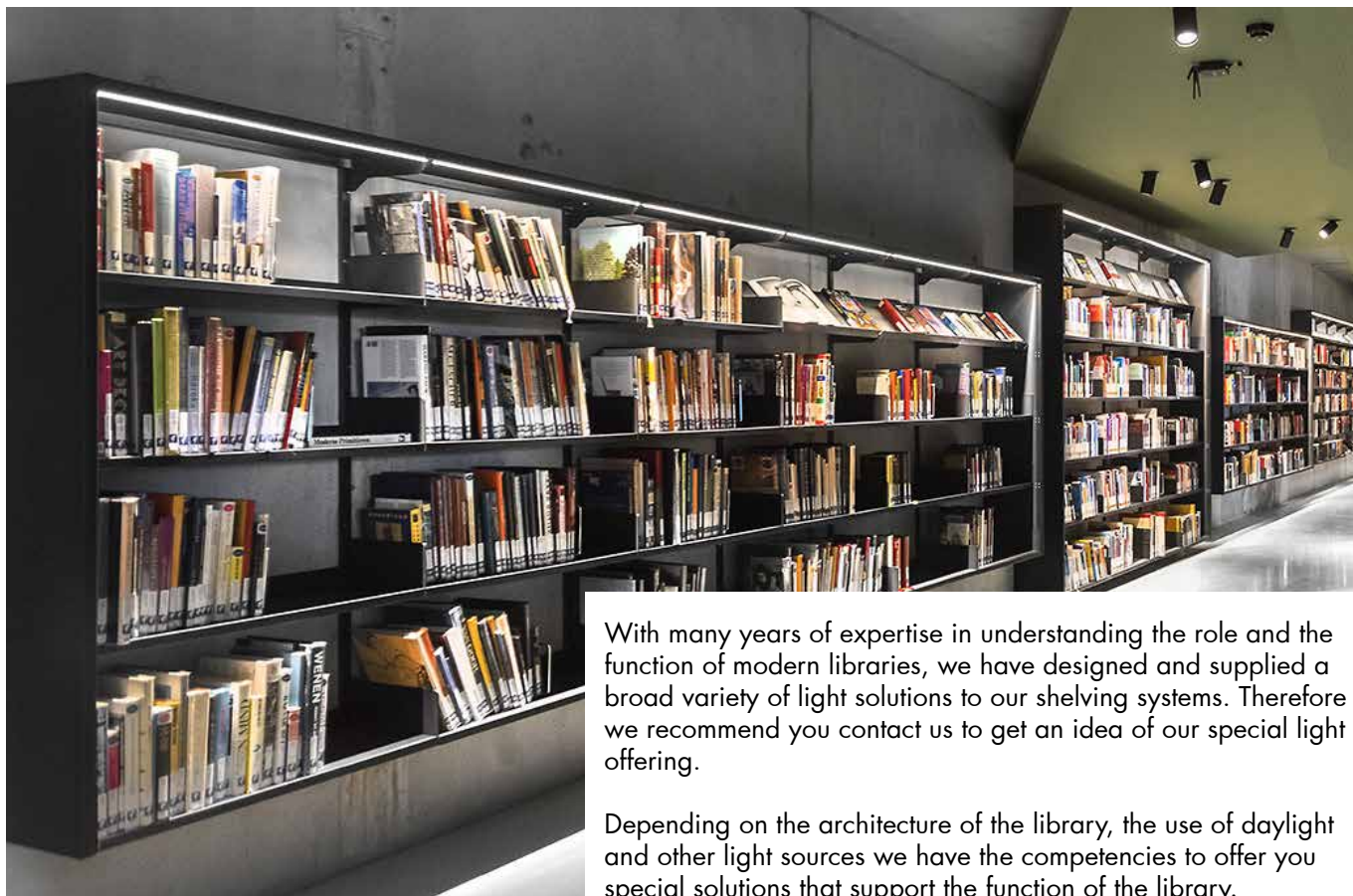

With many years of expertise in understanding the role and the function of modern libraries, we have designed and supplied a broad variety of light solutions to our shelving systems. Therefore we recommend you contact us to get an idea of our special light offering.

Depending on the architecture of the library, the use of daylight and other light sources we have the competencies to offer you special solutions that support the function of the library.

The LED lighting strips are mounted underneath each steel shelf to add light to the shelf below. You can find complete shelving configurations on page 40. Below you will find an overview of all components used in a configuration with LED lighting. It is also possible to construct your own shelving using the standard and special constructed components for LED lighting, contact Sales for further details.

### Warm white LED lighting

Selfadhesive. 3000 kelvin. 12V. 4.8 W per meter. Energy efficiency A+. 60 diodes per meter. Light output (lm) 4.1 per meter.

Module cm  
75  
90  
100

Item no.	Price DKK
B3900208	644
B3900205	666
B3900200	673

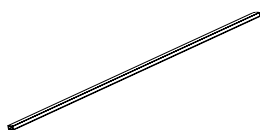

### 12V DC transformer for LED lighting

Up to 6 connections. 30 W. IP20.

Item no.	Price DKK
B3900202	484

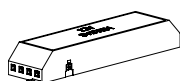



# LIGHTING

## LED SHELF LIGHTING

### Transformer holder for LED lighting

1 pc. needed per bay.



Module cm
75
90
100

Item no.	Price DKK
B3030037	469
B3030039	506
B3030031	552

### Cable channel for LED lighting

To be mounted on the left hand side of the bay, on the inside of the upright.

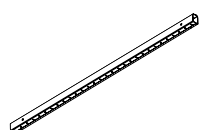

Height cm
122
152
182
212

Item no.	Price DKK
B3030042	518
B3030045	770
B3030048	918
B3030041	1.040

### Upright for LED lighting

With extra holes for mounting cable channel.

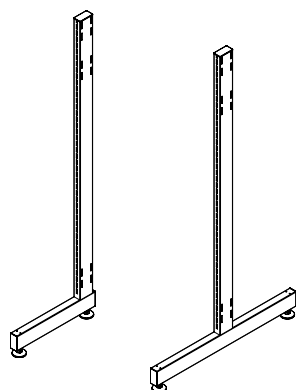

Height cm	Depth cm	Item no. - single	Price DKK	Item no. - double	Price DKK
122	22,5	B303000211	1.106	B303000212	1.210
122	25	B303000221	1.153	B303000222	1.240
122	30	B303000231	1.171	B303000232	1.287
122	40	B303000241	1.202	B303000242	1.335
152	22,5	B303000511	1.227	B303000512	1.352
152	25	B303000521	1.253	B303000522	1.380
152	30	B303000531	1.268	B303000532	1.415
152	40	B303000541	1.288	B303000542	1.487
182	22,5	B303000811	1.335	B303000812	1.415
182	25	B303000821	1.353	B303000822	1.476
182	30	B303000831	1.372	B303000832	1.515
182	40	B303000841	1.405	B303000842	1.589
212	22,5	B303000111	1.449	B303000112	1.576
212	25	B303000121	1.473	B303000122	1.595
212	30	B303000131	1.492	B303000132	1.612
212	40	B303000141	1.521	B303000142	1.682

### Crossbar

2 pcs. per bay.

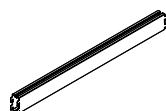

Module cm
75
90
100

Item no.	Price DKK
B3030027	475
B3030029	513
B3030021	560

### Steel shelves

The LED lighting is mounted underneath standard steel top shelves and steel intermediate shelves with backedge. See pages 66-73.

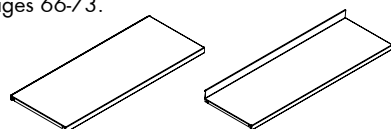



The Book LED lighting armature can be fitted on wooden top shelves and can be mounted over 1, 2 and 3 bays by use of connect fittings. Continuous runs also require connect fitting.

The armature is CE-approved and available in white and steel as standard. For other colours, please ask customer service.

#### Armature

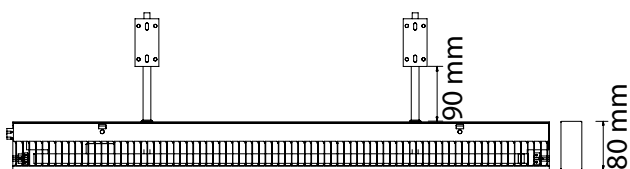

Model showing 2 bearing arms incl. light tube and louvre. Armature housing in aluminium.

#### Standard bearing arms

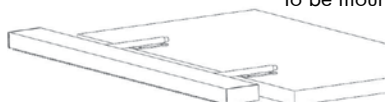

To be mounted on top of top shelf.

#### Front edge bearing arms

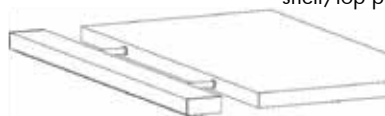

To be mounted on frontedge of predrilled top shelf/top plate (special request)

# LIGHTING

## BOOK LED LIGHTING

Below you will find a list of products needed when ordering lighting for 1, 2 or 3 bays. For 4 or more bays, you must use a combination of the armatures for 1, 2 or 3 bays by connecting the armatures with a connect fitting. Eg. for 10 bays, you can either use 5 x 2 bays (with 4 connect fittings) or 3 x 3 bays and 1 x 1 bay (with 3 connect fittings).

### 1 bay



	Item no.	Price DKK
Armature module 75 - W750 x D80 x H32 mm or	B3900100750	5.416
Armature module 90 - W900 x D80 x H32 mm or	B3900100900	5.847
Armature module 100 - W1005 x D80 x H32 mm	B3900101005	6.910
Bearing arms, 2 pcs., standard or	B39001512	1.204
Bearing arms, 2 pcs., front edge	B39001522	1.204
End covers, 2 pcs.	B390011	735

### 2 bays

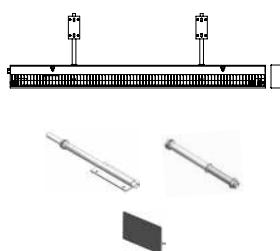

	Item no.	Price DKK
Armature module 75 + 75 - W1500 x D80 x H32 mm or	B3900101500	8.285
Armature module 90 + 90 - W1800 x D80 x H32 mm or	B3900101800	9.299
Armature module 90 + 100 - W1905 x D80 x H32 mm or	B3900101905	9.471
Armature module 100 + 100 - W2010 x D80 x H32 mm	B3900102010	10.244
Bearing arms, 2 pcs., standard or	B39001512	1.204
Bearing arms, 2 pcs., front edge	B39001522	1.204
End covers, 2 pcs.	B390011	735

### 3 bays



	Item no.	Price DKK
Armature module 75 + 75 + 75 - W2250 x D80 x H32 mm or	B3900102250	10.244
Armature module 75 + 90 + 75 - W2400 x D80 x H32 mm or	B3900102400	12.427
Armature module 90 + 90 + 90 - W2700 x D80 x H32 mm or	B3900102700	13.616
Armature module 100 + 90 + 100 - W2910 x D80 x H32 mm or	B3900102910	14.577
Armature module 100 + 100 + 100 - W3015 x D80 x H32 mm	B3900103015	15.306
Bearing arms, 3 pcs., standard or	B39001513	1.684
Bearing arms, 3 pcs., front edge	B39001523	1.684
End covers, 2 pcs.	B390011	735

### Cable 3 x 1.5 mm<sup>2</sup>, L2500 mm

Item no.	Price DKK
B390013	545

### Connect fitting



Item no.	Price DKK
B390012	157



École Nationale des Ponts et Chaussées (ENPC), Champs sur Marne, France  
60/30 Classic round steel shelving

# 60/30 CLASSIC ROUND STEEL SHELVING

## CONFIGURATIONS - WITHOUT SHELVES

Double-sided shelving system with uprights and crossbars. For shelves, see page 168.

### Height 92 cm

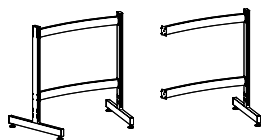
	Degree	Shelf depth cm	Item no. Starter bay	Price DKK	Item no. Add-on bay	Price DKK
	26°	30	BB3031073600	6.684	BB3031173600	5.540
	18°	30	BB3031073800	8.886	BB3031173800	7.742

### Height 122 cm

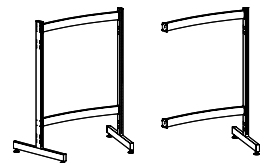
	Degree	Shelf depth cm	Item no. Starter bay	Price DKK	Item no. Add-on bay	Price DKK
	26°	30	BB3031023600	6.830	BB3031123600	5.613
	18°	30	BB3031023800	9.032	BB3031123800	7.815

### Height 152 cm

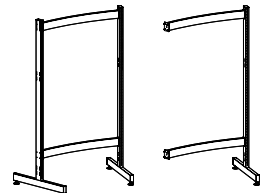
	Degree	Shelf depth cm	Item no. Starter bay	Price DKK	Item no. Add-on bay	Price DKK
	26°	30	BB3031053600	7.110	BB3031153600	5.753
	18°	30	BB3031053800	9.312	BB3031153800	7.955

### Height 182 cm

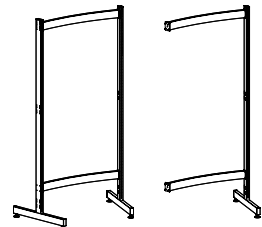
	Degree	Shelf depth cm	Item no. Starter bay	Price DKK	Item no. Add-on bay	Price DKK
	26°	30	BB3031083600	7.424	BB3031183600	5.910
	18°	30	BB3031083800	9.626	BB3031183800	8.112

### Height 212 cm

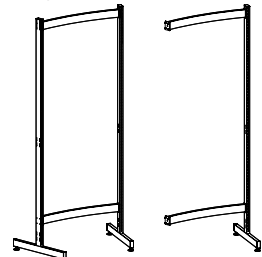
	Degree	Shelf depth cm	Item no. Starter bay	Price DKK	Item no. Add-on bay	Price DKK
	26°	30	BB3031013600	7.744	BB3031113600	6.070
	18°	30	BB3031013800	9.946	BB3031113800	8.272

# 60/30 CLASSIC ROUND STEEL SHELVING

## CONFIGURATIONS - WITH SHELVES - WITHOUT TOP SHELF

Complete double-sided shelving system with uprights, crossbars, shelves, brackets, galvanized safety clip and fittings (the safety clip is available in standard steel colours and can be ordered separately, see page 175). Shelves are rounded steel shelves with backedge. Number of shelves are calculated for optimal shelf spacing for fiction. A starter bay is delivered with one right and one left bracket per shelf. An add-on bay is delivered with a double bracket per shelf, which places the shelves in the same height as that of the starter bay.

### Height 92 cm (2 shelves on each side)

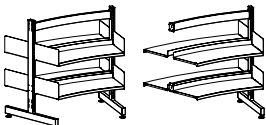
	Degree	Shelf depth cm	Item no. Starter bay	Price DKK	Item no. Add-on bay	Price DKK	
	Ø432 cm	26°	30	BB3031073620	14.752	BB3031173620	13.180
	Ø600 cm	18°	30	BB3031073820	16.954	BB3031173820	15.382

### Height 122 cm (3 shelves on each side)

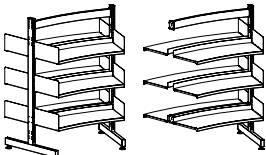
	Degree	Shelf depth cm	Item no. Starter bay	Price DKK	Item no. Add-on bay	Price DKK	
	Ø432 cm	26°	30	BB3031023630	18.932	BB3031123630	17.073
	Ø600 cm	18°	30	BB3031023830	21.134	BB3031123830	19.275

### Height 152 cm (4 shelves on each side)

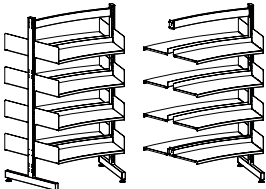
	Degree	Shelf depth cm	Item no. Starter bay	Price DKK	Item no. Add-on bay	Price DKK	
	Ø432 cm	26°	30	BB3031053640	23.246	BB3031153640	21.033
	Ø600 cm	18°	30	BB3031053840	25.448	BB3031153840	23.235

### Height 182 cm (5 shelves on each side)

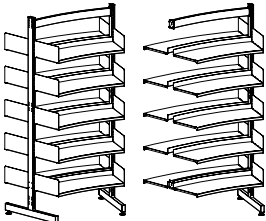
	Degree	Shelf depth cm	Item no. Starter bay	Price DKK	Item no. Add-on bay	Price DKK	
	Ø432 cm	26°	30	BB3031083650	27.594	BB3031183650	25.010
	Ø600 cm	18°	30	BB3031083850	29.796	BB3031183850	27.212

### Height 212 cm (6 shelves on each side)

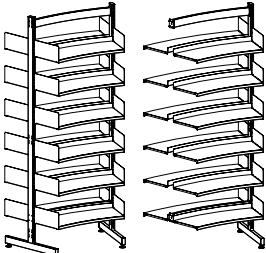
	Degree	Shelf depth cm	Item no. Starter bay	Price DKK	Item no. Add-on bay	Price DKK	
	Ø432 cm	26°	30	BB3031013660	31.948	BB3031113660	28.990
	Ø600 cm	18°	30	BB3031013860	34.150	BB3031113860	31.192

# 60/30 CLASSIC ROUND STEEL SHELVING

## CONFIGURATIONS - WITH SHELVES AND TOP SHELVES

Complete double-sided shelving system with uprights, crossbars, shelves, top shelves, brackets, galvanized safety clip and fittings (the safety clip is available in standard steel colours and can be ordered separately, see page 175). Shelves are rounded steel shelves with backedge, top shelves are steel shelves without backedge. Number of shelves are calculated for optimal shelf spacing for fiction. A starter bay is delivered with one right and one left bracket per shelf. An add-on bay is delivered with a double bracket per shelf, which places the shelves in the same height as that of the starter bay.

### Height 92 cm (2 shelves + top shelf on each side)

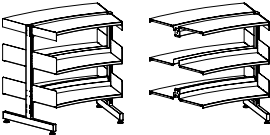
	Degree	Shelf depth cm	Item no. Starter bay	Price DKK	Item no. Add-on bay	Price DKK
	26°	30	BB3031073621	18.691	BB3031173621	16.905
	18°	30	BB3031073821	22.640	BB3031173821	20.854

### Height 122 cm (3 shelves + top shelf on each side)

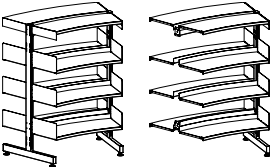
	Degree	Shelf depth cm	Item no. Starter bay	Price DKK	Item no. Add-on bay	Price DKK
	26°	30	BB3031023631	22.871	BB3031123631	20.798
	18°	30	BB3031023831	26.820	BB3031123831	24.747

### Height 152 cm (4 shelves + top shelf on each side)

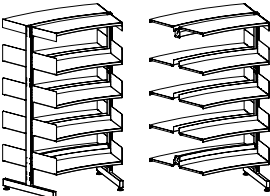
	Degree	Shelf depth cm	Item no. Starter bay	Price DKK	Item no. Add-on bay	Price DKK
	26°	30	BB3031053641	27.185	BB3031153641	24.758
	18°	30	BB3031053841	31.134	BB3031153841	28.707

### Height 182 cm (5 shelves + top shelf on each side)

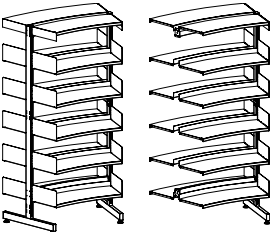
	Degree	Shelf depth cm	Item no. Starter bay	Price DKK	Item no. Add-on bay	Price DKK
	26°	30	BB3031083651	31.533	BB3031183651	28.735
	18°	30	BB3031083851	35.482	BB3031183851	32.684

### Height 212 cm (6 shelves + top shelf on each side)

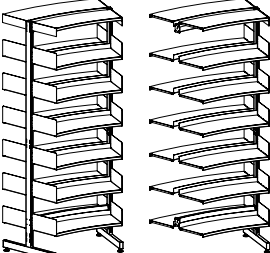
	Degree	Shelf depth cm	Item no. Starter bay	Price DKK	Item no. Add-on bay	Price DKK
	26°	30	BB3031013661	35.887	BB3031113661	32.715
	18°	30	BB3031013861	39.836	BB3031113861	36.664

# ROUND SHELVES

## ROUND STEEL SHELVES

See below for overview of standard round steel shelves:

---

### B301500 - ROUND STEEL SHELF WITH STEEL BACKEDGE - 25 MM FRONTEDGE

Details:

- 26°/18°
- Depth 300 mm
- Steel backedge H47 mm
- Steel plate brackets
- Max. weight 80 kg.

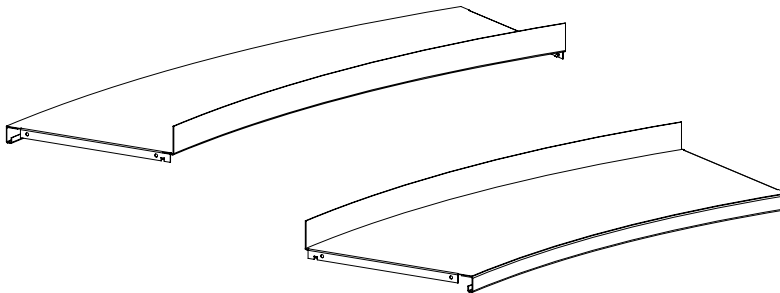



# ROUND SHELVES

## ROUND SINGLE-SIDED STEEL SHELF

### Round steel shelf with steel backedge - with brackets

With one left and one right bracket.

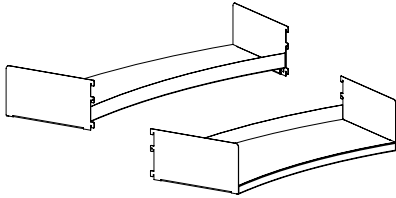

Degree	Shelf depth cm	Item no. Inner	Price DKK	Item no. Outer	Price DKK
26°	30	BB3030561	1.842	BB3030562	2.076
18°	30	BB3030581	1.842	BB3030582	2.076

### Round steel shelf with steel backedge - without brackets

Shelves for starter bays must be ordered with left and right brackets. Shelves for add-on bays must be ordered with double bracket.

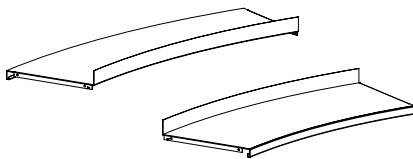

Degree	Shelf depth cm	Item no. Inner	Price DKK	Item no. Outer	Price DKK
26°	30	B301500613	1.612	B301500623	1.846
18°	30	B301500813	1.612	B301500823	1.846

### Steel plate bracket for steel shelves with steel backedge

H15 cm.

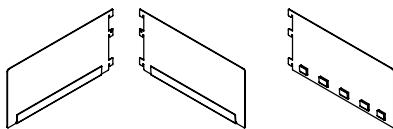

Type	Shelf depth cm	Item no.	Price DKK
Left	30	B30101437	115
Right	30	B30101438	115
Double	30	B30101439	123

# ROUND SHELVES

## ROUND STEEL TOP SHELVES

See below for overview of standard round steel top shelves:

---

### B301502 - SINGLE-SIDED ROUND STEEL TOP SHELF - 25 MM FRONTEDGE

Details:

- 26°/18°
- Depth 300 mm
- Steel brackets
- Max. weight 25 kg.

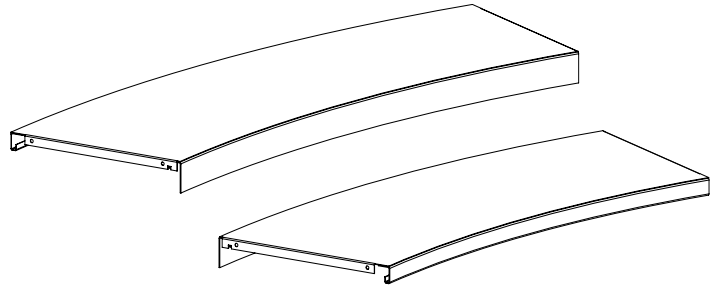

---

### B301531 - DOUBLE-SIDED ROUND STEEL TOP SHELF - 25/47 MM FRONTEDGE

Details:

- 26°/18°
- Depth 660 mm
- Freestanding/outer/intermediate
- Steel brackets
- Max. weight 25 kg.

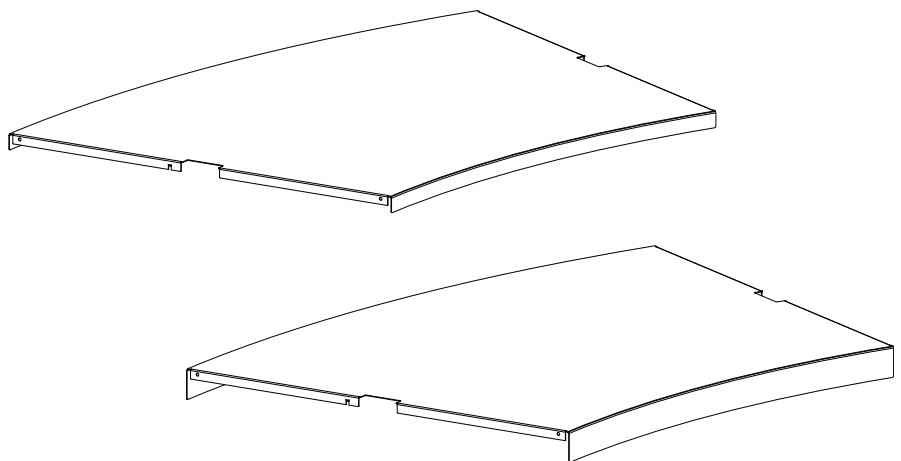

# ROUND SHELVES

## ROUND SINGLE-SIDED STEEL TOP SHELF

### Round single-sided steel top shelf

Order 1 inner and 1 outer shelf per section. Shelves for starter bays must be ordered with left and right brackets. Shelves for add-on bays must be ordered with double bracket.

Degree	Shelf depth cm	Item no. Inner	Price DKK	Item no. Outer	Price DKK
26°	30	B301502613	1.620	B301502623	1.859
18°	30	B301502813	2.431	B301502823	2.795

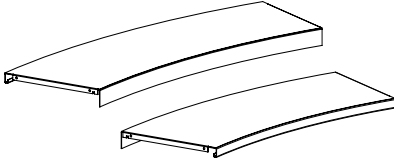

### Steel bracket for round single-sided steel shelf

H7.5 cm. Max. load of 25 kg.

Type	Shelf depth cm	Item no.	Price DKK
Left	30	B30102437	115
Right	30	B30102438	115
Double	30	B30102439	123

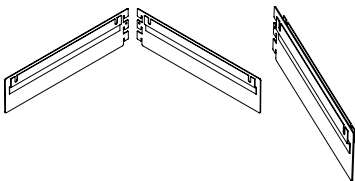

# ROUND SHELVES

## ROUND DOUBLE-SIDED STEEL TOP SHELF WITH BRACKETS

### Double-sided steel top shelf with brackets - for 1 freestanding bay

2 left and 2 right brackets included.

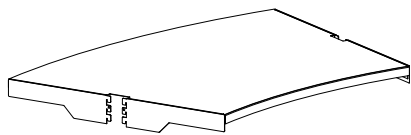
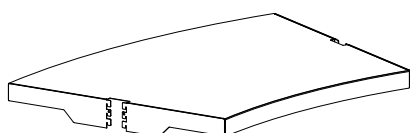
	Degree	Shelf depth cm	Front edge cm	Item no.	Price DKK
	26°	30	25	BB3030765125	
	18°	30	25	BB3030785125	
	26°	30	47	BB3030765147	
	18°	30	47	BB3030785147	

### Double-sided steel top shelf with brackets - for 1 left, outer bay

1 left, 1 right and 1 double bracket included.

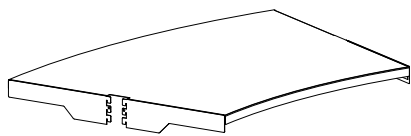
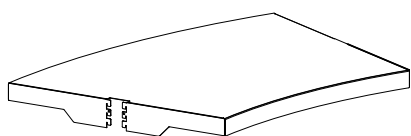
	Degree	Shelf depth cm	Front edge cm	Item no.	Price DKK
	26°	30	25	BB3030761125	
	18°	30	25	BB3030781125	
	26°	30	47	BB3030761147	
	18°	30	47	BB3030781147	

### Double-sided steel top shelf with brackets - for 1 intermediate bay

2 double brackets included.

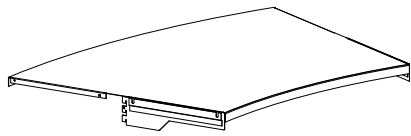
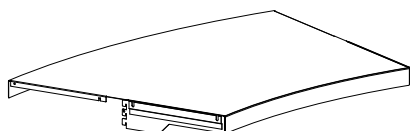
	Degree	Shelf depth cm	Front edge cm	Item no.	Price DKK
	26°	30	25	BB3030763125	
	18°	30	25	BB3030783125	
	26°	30	47	BB3030763147	
	18°	30	47	BB3030783147	

### Double-sided steel top shelf with brackets - for 1 right, outer bay

1 left, 1 right and 1 double bracket included.

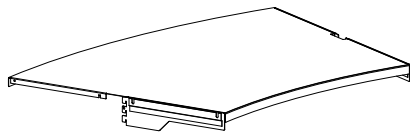
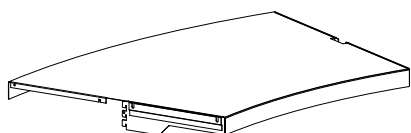
	Degree	Shelf depth cm	Front edge cm	Item no.	Price DKK
	26°	30	25	BB3030762125	
	18°	30	25	BB3030782125	
	26°	30	47	BB3030762147	
	18°	30	47	BB3030782147	

# ROUND SHELVES

## ROUND DOUBLE-SIDED STEEL TOP SHELF

### Double-sided steel top shelf without brackets - for 1 freestanding bay

2 left and 2 right brackets to be ordered separately. See page 175.

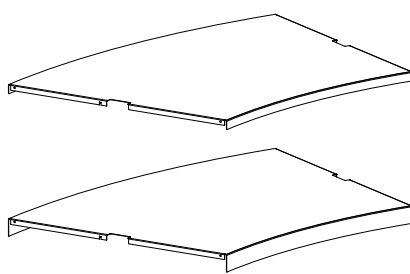

Degree	Shelf depth cm	Front edge cm
26°	30	25
18°	30	25
26°	30	47
18°	30	47

Item no.	Price DKK
B30153165125	
B30153185125	
B30153165147	
B30153185147	

### Double-sided steel top shelf without brackets - for 1 left, outer bay

1 left, 1 right and 1 double brackets to be ordered separately. See page 175.

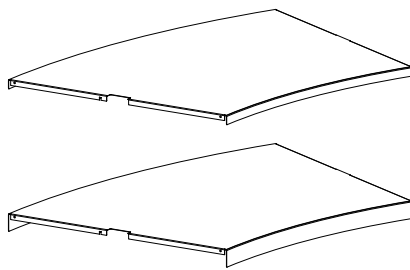

Degree	Shelf depth cm	Front edge cm
26°	30	25
18°	30	25
26°	30	47
18°	30	47

Item no.	Price DKK
B30153161125	
B30153181125	
B30153161147	
B30153181147	

### Double-sided steel top shelf without brackets - for 1 intermediate bay

2 double brackets to be ordered separately. See page 175.

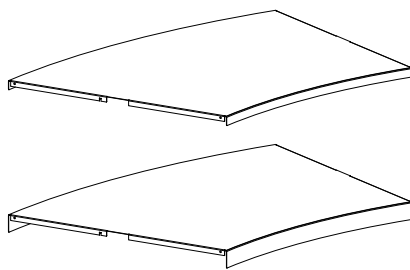

Degree	Shelf depth cm	Front edge cm
26°	30	25
18°	30	25
26°	30	47
18°	30	47

Item no.	Price DKK
B30153163125	
B30153183125	
B30153163147	
B30153183147	

### Double-sided steel top shelf without brackets - for 1 right, outer bay

1 left, 1 right and 1 double brackets to be ordered separately. See page 175.

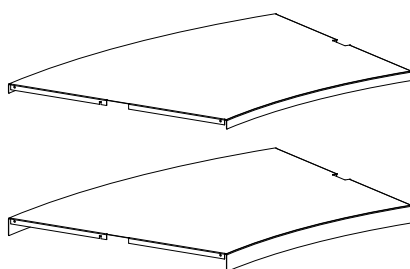

Degree	Shelf depth cm	Front edge cm
26°	30	25
18°	30	25
26°	30	47
18°	30	47

Item no.	Price DKK
B30153162125	
B30153182125	
B30153162147	
B30153182147	



# COMPONENTS FOR ROUND STEEL SHELVES

## BRACKETS, SHELF STRENGTHENER AND SAFETY CLIPS

### Steel bracket for steel top shelf B301531

Max. load of 25 kg.

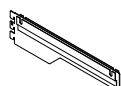
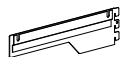

Type	Shelf depth cm	Item no.	Price DKK
Left	30	B30102937	115
Right	30	B30102938	115
Double	30	B30102939	123

### Shelf strengthener

Max. load on round shelf is 30 kg.

Max. load on round shelf with shelf strengthener is 80 kg.

Degree	Shelf depth cm	Item no. Inner	Price DKK	Item no. Outer	Price DKK
26°	30	B301540613	328	B301540623	392
18°	30	B301540813	328	B301540823	392



### Safety clip

Two used per outer shelf. Hooks into the upright to prevent the shelf from possible tipping.

Finish	Item no.	Price DKK
Painted	B301530	58

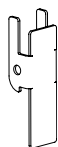

# ROUND SHELVES

## FSC DOUBLE-SIDED ROUND LONDON WOODEN TOP PLATE

See below for overview of standard round wooden top plate:

---

### B302134 - FSC DOUBLE-SIDED ROUND LONDON WOODEN TOP PLATE - 30 MM FRONTEDGE

Details:

- 26°/18°
- Depth 300 mm
- Steel plate brackets
- Max. weight 25 kg.

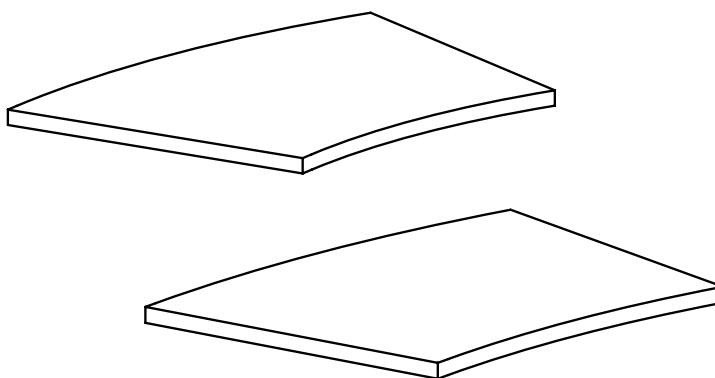



# ROUND SHELVES

## FSC DOUBLE-SIDED ROUND LONDON WOODEN TOP PLATE

### FSC double-sided round London wooden top plate with brackets

D66 cm, 30 mm front edge.  
Incl. brackets.

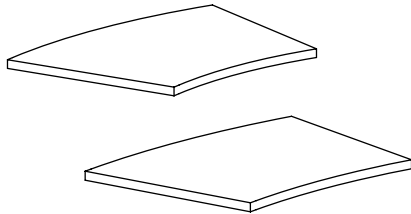

Degree	Type	Item no. 1 bay	Price DKK
26°	Freestanding	B302137365	5.085
18°	Freestanding	B302137385	5.085
26°	Left	B302137361	5.085
18°	Left	B302137381	5.085
26°	Right	B302137362	5.085
18°	Right	B302137382	5.085
26°	Intermediate	B302137363	5.139
18°	Intermediate	B302137383	5.139

### Bracket for FSC double-sided London round wooden top plate

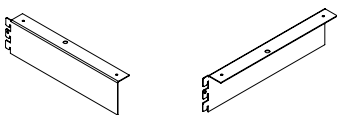

Type	Item no.	Price DKK
Left	B30120038	105
Right	B30120039	105

# COMPONENTS FOR ROUND SHELVING

## UPRIGHT AND CROSSBAR

### Upright

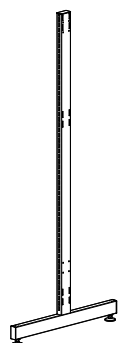

Height cm	Shelf depth cm	Item no.	Price DKK
92	30	B3015197	1.144
122	30	B3015192	1.217
152	30	B3015195	1.357
182	30	B3015198	1.514
212	30	B3015191	1.674

### Round crossbar

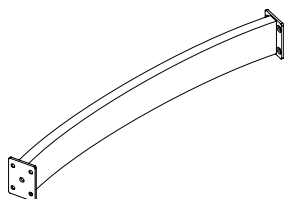

Degree	Shelf depth cm	Item no.	Price DKK
26°	30	B3015106	2.198
18°	30	B3015108	3.299

# COMPONENTS FOR ROUND SHELVING

## CASTORS AND PLINTHS

### Castors

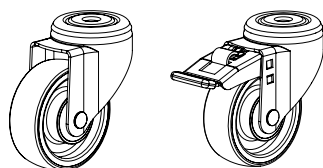

Type	Item no.	Price DKK
Without brakes	B3060000	390
With brakes	B3060001	543

### Round steel plinth

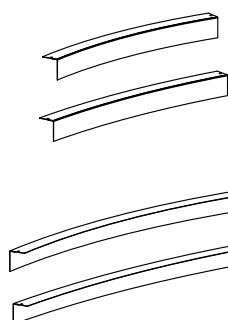

Degree	Curve	Item no.	Price DKK
26°	Inner	B30152761	1.304
18°	Inner	B30152781	1.304
26°	Outer	B30152762	1.304
18°	Outer	B30152782	1.304

### Round castor frame set with hidden castors and steel plinth

A set of 2 frames, 4 x Ø35 mm castors without brakes and 2 steel plinths. Fittings included. Holes must be predrilled in the foot of the upright B301519 for installation.

Degree	Item no.	Price DKK
26°	B3015506	4.282
18°	B3015508	4.282

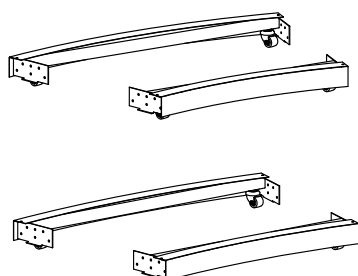



# PANELS FOR ROUND SHELVING

## WOODEN END PANELS

### FSC painted wooden end panel - double-sided

19 mm front edge. Incl. fittings. These end panels are not compatible with hidden castor frames.

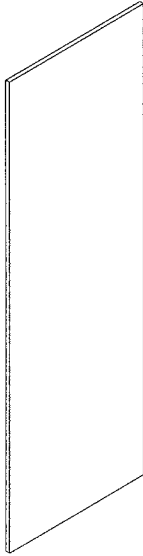

Height cm	Shelf depth cm	Item no.	Price DKK
92	30	B3016657395	1.652
122	30	B3016652395	2.190
152	30	B3016655395	2.668
182	30	B3016658395	3.155
199.5	30	B3016659395	3.553
212	30	B3016651395	3.642

### FSC veneer wooden end panel - double-sided

19 mm front edge. Incl. fittings. These end panels are not compatible with hidden castor frames.

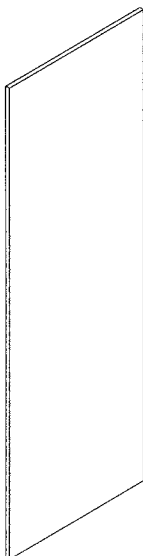

Height cm	Shelf depth cm	Item no.	Price DKK
92	30	B3016657391	2.313
122	30	B3016652391	3.067
152	30	B3016655391	3.735
182	30	B3016658391	4.417
199.5	30	B3016659391	4.974
212	30	B3016651391	5.099

# PANELS FOR ROUND SHELVING

## WOODEN SLAT END PANELS

### FSC painted wooden slat end panel - double-sided

22 mm front edge. Incl. fittings. These end panels are not compatible with hidden castor frames.

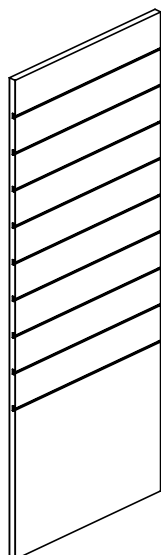

Height cm	Shelf depth cm	Item no.	Price DKK
92	30	B3016747395	2.315
122	30	B3016742395	3.069
152	30	B3016745395	3.614
182	30	B3016748395	3.982
212	30	B3016741395	4.477

### FSC veneer wooden slat end panel - double-sided

22 mm front edge. Incl. fittings. These end panels are not compatible with hidden castor frames.

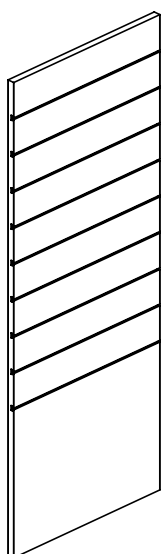

Height cm	Shelf depth cm	Item no.	Price DKK
92	30	B3016747391	3.242
122	30	B3016742391	4.296
152	30	B3016745391	5.060
182	30	B3016748391	5.575
212	30	B3016741391	6.268

# PANELS FOR ROUND SHELVING

## LONDON WOODEN END PANELS

### FSC painted London wooden end panel for steel top shelf - double-sided

30 mm front edge. To be used with steel top shelf, see page 170. Incl. fittings.

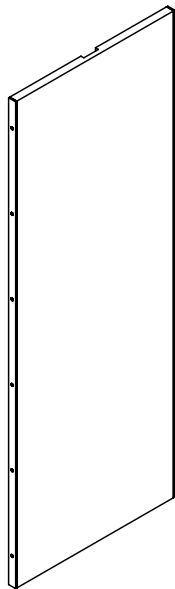

Height cm	Shelf depth cm	Item no.	Price DKK
92	30	B3021257392	2.901
122	30	B3021252392	3.662
152	30	B3021255392	4.362
182	30	B3021258392	5.064
212	30	B3021251392	5.824

### FSC painted London wooden end panel for wooden overlaying top plate - double-sided

30 mm front edge. To be used with London wooden overlaying top, see page 176. Incl. fittings.

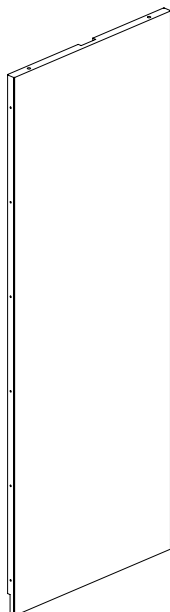

Height cm	Shelf depth cm	Item no.	Price DKK
92	30	B3021257391	2.901
122	30	B3021252391	3.662
152	30	B3021255391	4.362
182	30	B3021258391	5.064
212	30	B3021251391	5.824

# PANELS FOR ROUND SHELVING

## PERFORATED STEEL END PANEL

### Perforated steel end panels - double-sided

45 mm front edge. Two A5 acrylic covers for signage and fittings included.  
Hole size Ø4,5 mm.

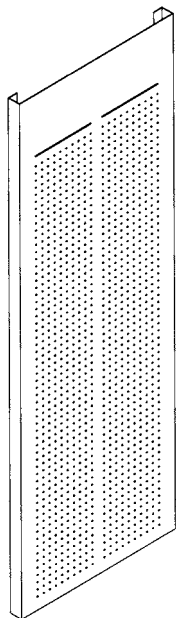

Height cm	Shelf depth cm	Item no.	Price DKK
92	30	B301600739	1.635
122	30	B301600239	1.719
152	30	B301600539	2.175
182	30	B301600839	2.449
199.5	30	B301600939	2.621
212	30	B301600139	2.737



# PANELS FOR ROUND SHELVING

## FITTINGS FOR PANELS

---

### Fittings for wooden end panel

Type	Heights < 152 cm Item no.	Price DKK	Heights > =152 cm Item no.	Price DKK
Left	B30165227	179	B30165217	250
Right	B30165228	179	B30165218	250
Double	B30165229	356	B30165219	491

---

### Fittings for wooden display end panel

Type	Item no. Heights < 152 cm	Price DKK	Item no. Heights > =152 cm	Price DKK
Left	B30167227	179	B30167217	250
Right	B30167228	179	B30167218	250
Double	B30167229	356	B30167219	491

---



# END PANEL BAYS

FOR ROUND DOUBLE-SIDED 60/30 CLASSIC STEEL SHELVING

The following pages will show basic configurations of end panel bays for double-sided 60/30 Classic Steel Shelving system.



# END PANEL BAYS

## FOR ROUND DOUBLE-SIDED 60/30 CLASSIC STEEL SHELVING

FSC-approved end panel bay with wooden top shelf, wooden panels, wooden bottom shelf and adjustable feet. For shelves, see page 194.

### Height 92 cm

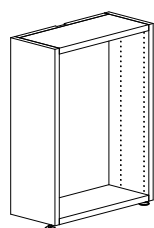

Depth of shelving system - cm	Width of end panel bay - cm	Depth of end panel bay - cm	Item no. Painted	Price DKK	Item no. Veneer	Price DKK
30/30	61,8	25	BB30132722005	9.550	BB30132722001	13.370
30/30	61,8	30	BB30132723005	9.550	BB30132723001	13.370

### Height 122

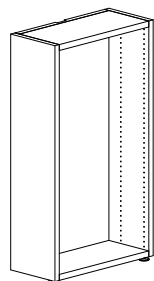

Depth of shelving system - cm	Width of end panel bay - cm	Depth of end panel bay - cm	Item no. Painted	Price DKK	Item no. Veneer	Price DKK
30/30	61,8	25	BB30132222005	12.536	BB30132222001	17.550
30/30	61,8	30	BB30132223005	12.536	BB30132223001	17.550

### Height 152 cm

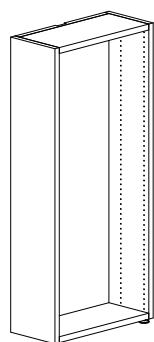

Depth of shelving system - cm	Width of end panel bay - cm	Depth of end panel bay - cm	Item no. Painted	Price DKK	Item no. Veneer	Price DKK
30/30	61,8	25	BB30132522005	15.517	BB30132522001	21.724
30/30	61,8	30	BB30132523005	15.517	BB30132523001	21.724

# END PANEL BAYS

FOR ROUND DOUBLE-SIDED 60/30 CLASSIC STEEL SHELVING

FSC-approved end panel bay with wooden top shelf, wooden panels, wooden bottom shelf and adjustable feet. For shelves, see page 194.

## Height 182 cm

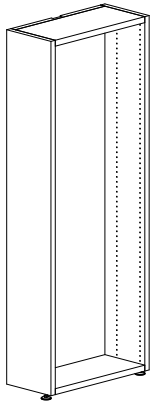

Depth of shelving system - cm	Width of end panel bay - cm	Depth of end panel bay - cm	Item no. Painted	Price DKK	Item no. Veneer	Price DKK
30/30	61,8	25	BB30132822005	18.503	BB30132822001	25.904
30/30	61,8	30	BB30132823005	18.503	BB30132823001	25.904

## Height 212 cm

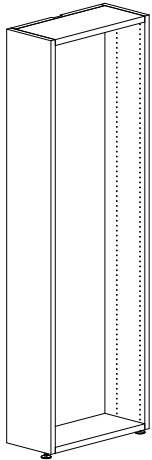

Depth of shelving system - cm	Width of end panel bay - cm	Depth of end panel bay - cm	Item no. Painted	Price DKK	Item no. Veneer	Price DKK
30/30	61,8	25	BB30132122005	21.484	BB30132122001	30.078
30/30	61,8	30	BB30132123005	21.484	BB30132123001	30.078

# END PANEL BAYS

FOR ROUND DOUBLE-SIDED SHELVING WITH AJDUSTABLE FEET & LONDON WOODEN TOP PLATE

FSC-approved end panel bay with overlaying London wooden top plate, wooden panels, wooden bottom shelf and adjustable feet. For shelves, see page 194.

## Height 92 cm

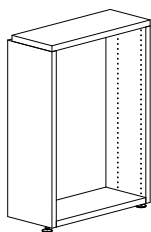

Depth of shelving system - cm	Width of end panel bay - cm	Depth of end panel bay - cm	Item no. Painted	Price DKK	Item no. Veneer	Price DKK
30/30	61,8	25	BB30133722005	9.550	BB30133722001	13.370
30/30	61,8	30	BB30133723005	9.550	BB30133723001	13.370

## Height 122

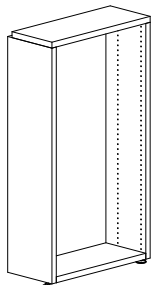

Depth of shelving system - cm	Width of end panel bay - cm	Depth of end panel bay - cm	Item no. Painted	Price DKK	Item no. Veneer	Price DKK
30/30	61,8	25	BB30133222005	12.536	BB30133222001	17.550
30/30	61,8	30	BB30133223005	12.536	BB30133223001	17.550

## Height 152 cm

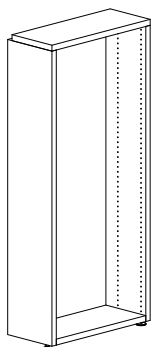

Depth of shelving system - cm	Width of end panel bay - cm	Depth of end panel bay - cm	Item no. Painted	Price DKK	Item no. Veneer	Price DKK
30/30	61,8	25	BB30133522005	15.517	BB30133522001	21.724
30/30	61,8	30	BB30133523005	15.517	BB30133523001	21.724

# END PANEL BAYS

FOR ROUND DOUBLE-SIDED SHELVING WITH ADJUSTABLE FEET & LONDON WOODEN TOP PLATE

FSC-approved end panel bay with overlaying London wooden top plate, wooden panels, wooden bottom shelf and adjustable feet. For shelves, see page 194.

## Height 182 cm

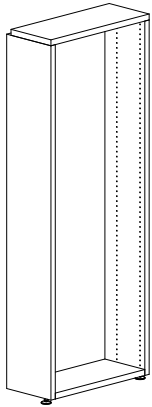

Depth of shelving system - cm	Width of end panel bay - cm	Depth of end panel bay - cm	Item no. Painted	Price DKK	Item no. Veneer	Price DKK
30/30	61,8	25	BB30133822005	18.503	BB30133822001	25.904
30/30	61,8	30	BB30133823005	18.503	BB30133823001	25.904

## Height 212 cm

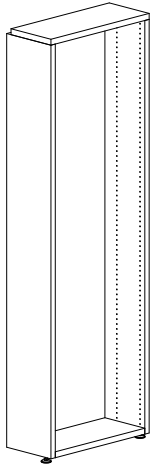

Depth of shelving system - cm	Width of end panel bay - cm	Depth of end panel bay - cm	Item no. Painted	Price DKK	Item no. Veneer	Price DKK
30/30	61,8	25	BB30133122005	21.484	BB30133122001	30.078
30/30	61,8	30	BB30133123005	21.484	BB30133123001	30.078

# END PANEL BAYS

## FOR ROUND DOUBLE-SIDED SHELVING WITH CASTORS

FSC-approved end panel bay with wooden top shelf, wooden panels, wooden bottom shelf and castors. For shelves, see page 194.

### Height 92 cm

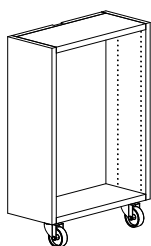

Depth of shelving system - cm	Width of end panel bay - cm	Depth of end panel bay - cm	Item no. Painted	Price DKK	Item no. Veneer	Price DKK
30/30	61,8	25	BB30136722005	10.330	BB30136722001	14.462
30/30	61,8	30	BB30136723005	10.330	BB30136723001	14.462

### Height 122

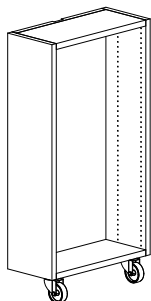

Depth of shelving system - cm	Width of end panel bay - cm	Depth of end panel bay - cm	Item no. Painted	Price DKK	Item no. Veneer	Price DKK
30/30	61,8	25	BB30136222005	13.316	BB30136222001	18.642
30/30	61,8	30	BB30136223005	13.316	BB30136223001	18.642

### Height 152 cm

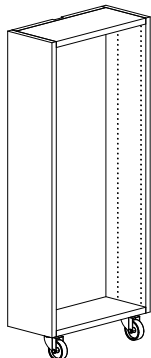

Depth of shelving system - cm	Width of end panel bay - cm	Depth of end panel bay - cm	Item no. Painted	Price DKK	Item no. Veneer	Price DKK
30/30	61,8	25	BB30136522005	16.297	BB30136522001	22.816
30/30	61,8	30	BB30136523005	16.297	BB30136523001	22.816



# END PANEL BAYS

FOR ROUND DOUBLE-SIDED SHELVING WITH CASTORS & LONDON WOODEN TOP PLATE

FSC-approved end panel bay with overlaying London wooden top plate, wooden panels, wooden bottom shelf and castors. For shelves, see page 194.

## Height 92 cm

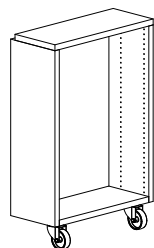

Depth of shelving system - cm	Width of end panel bay - cm	Depth of end panel bay - cm	Item no. Painted	Price DKK	Item no. Veneer	Price DKK
30/30	61,8	25	BB30137222005	13.316	BB30137222001	18.642
30/30	61,8	30	BB30137223005	13.316	BB30137223001	18.642

## Height 122

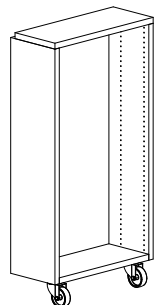

Depth of shelving system - cm	Width of end panel bay - cm	Depth of end panel bay - cm	Item no. Painted	Price DKK	Item no. Veneer	Price DKK
30/30	61,8	25	BB30137522005	16.297	BB30137522001	22.816
30/30	61,8	30	BB30137523005	16.297	BB30137523001	22.816

## Height 152 cm

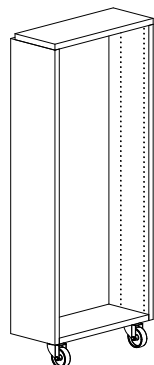

Depth of shelving system - cm	Width of end panel bay - cm	Depth of end panel bay - cm	Item no. Painted	Price DKK	Item no. Veneer	Price DKK
30/30	61,8	25	BB30137722005	10.330	BB30137722001	14.462
30/30	61,8	30	BB30137723005	10.330	BB30137723001	14.462

# END PANEL BAYS

## STEEL SHELVES

### Steel shelf with steel backedge for backedge book support

Steel backedge 47 mm. Brackets must be ordered separately.	Depth of shelving system - cm	Depth of end panel bay - cm	Width of shelf - cm	Item no.	Price DKK
	30/30	25	61,3	B30118222	580
	30/30	30	61,3	B30118223	580

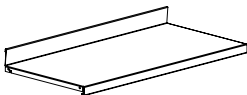

### Bracket for steel shelves with steel backedge

\* Can be used for D25 and 30 cm shelves.

Type	Depth of end panel bay - cm	Item no.	Price DKK
Left	25	B78300128	134
Right	25	B78300129	134
Left*	30	B78300138	134
Right*	30	B78300139	134

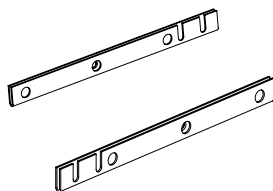

### 45°/60° sloping steel shelf

With fittings.	Depth of shelving system - cm	Depth of end panel bay - cm	Item no.	Price DKK
	30/30	25	B30118622	551
	30/30	30	B30118623	551





# LOCATIONS

WE ARE LIBRARY PEOPLE®



## DENMARK

Lammhults Biblioteksdesign A/S  
Dalbækvej 1  
6670 Holsted

bci@bci.dk  
www.bci.dk

## FRANCE

BC Intérieur Sarl  
6 allée Kepler  
77420 Champs sur Marne

bci@bcinterieur.com  
www.bcinterieur.com

## BELGIUM

SBNL - Schulz Benelux BVBA  
Appelweg 94 C  
3221 Holsbeek

info@sbnl.be  
www.sbnl.be

## SWEDEN

Lammhults Biblioteksdesign AB  
Odlarevägen 16  
226 60 Lund

eurobib@eurobib.se  
www.eurobib.se

## GERMANY

Schulz Speyer Bibliothekstechnik AG  
Hafenstraße 2  
67346 Speyer

sales@schulzspeyer.de  
www.schulzspeyer.de

## UNITED KINGDOM

thedesignconcept Ltd.  
The Old Bakery,  
10 Greenless Road  
Cambuslang Belgrave Street  
Glasgow G72 8JJ

info@thedesignconcept.co.uk  
www.thedesignconcept.co.uk

## NORWAY

BS Eurobib AS  
Alf Bjerckes Vei 20  
0582 Oslo

post@bseurobib.no  
www.bseurobib.no