



INFORM SERIES

EUR PRICE LIST
01.01.2024



THE INFORM SERIES

Greet the users of the library with the clear design of the Inform series of counters, desks and search stations.

The Inform series is easily recognized due to its up to 40 mm thick panels, creating a continuous frame around the work space. The counter system is specially designed for library use and is both functional, expandable and allows to a great extent customization to your needs. Complement the counter with desks and search stations placed strategically around the library to create functional and user friendly work spaces for both the staff as well as the users of the library.

All three types of work spaces have a range of accessories available to create the right setting for all users.



The price list is valid from 01.01.2024 until 31.12.2024.

Conditions of sale and terms of delivery

All prices exclude VAT and delivery. Please see our conditions of sale and terms of delivery on our website.

Updating the price list











The price list will continually be updated and can be downloaded on our website. Please contact our sales office, who will forward a log-in and password via e-mail. We reserve the right to make product and price alterations without prior notice and accept no liability for printing errors.

DESIGN OPTIONS	4	COUNTER SHELVES	84
TECHNICAL SPECIFICATIONS	9	For rectangular counter	88
SEARCH STATION	10	For corner counter	89
DESKS	12	For 45° curved counter	90
COUNTER	18	For 90° curved counter	91
CONFIGURATION OPTIONS	19	DISPLAY AND STORAGE	92
STANDARD COUNTER	20	Corner display unit	93
Rectangular counter	22	Display cabinet with storage	95
45° curved counter	24	Display cabinet with drawers	97
90° curved counter	26	Display cabinet with shelves and shelving options	98
Rectangular counter (combination with recessed counter)	28	Display cabinet with book trolley	99
45° curved counter (combination with recessed counter)	30	Accessories for display cabinet	100
90° curved counter (combination with recessed counter)	32	FUNCTIONS	101
Connections	34	Bag shelves	103
Configurations	35	Counter top part with info sign	106
RECESSED COUNTER	36	Counter top part with bag shelf	108
Rectangular counter	38	Decorative board and info sign	111
45° curved counter	40	Functional accessories	113
90° curved counter	42	Power sockets	115
Rectangular counter (combination with standard counter)	44	FRONT PANEL OPTIONS	116
45° curved counter (combination with standard counter)	46	LED lighting	117
90° curved counter (combination with standard counter)	46	Graphics	119
Connections	50	DRILL HOLES FOR CABLE CONDUCT & RFID	120
Configurations	51		
STEP COUNTER	52		
Counter tops	54		
Front panels	55		
Middle panels	56		
Configurations	57		
CORNER COUNTER	58		
Square corner counter top and front panel	60		
Triangular corner counter top and front panel	61		
INFO TABLES	62		
Counter top with foot and side panel	64		
Counter top with panel and side panel	65		
HEIGHT ADJUSTABLE COUNTER	66		
Height adjustable rectangular counter	70		
H740 mm rectangular counter for height adjustable	72		
H740 mm 45° curved counter for height adjustable	74		
H740 mm 90° curved counter for height adjustable	76		
H740 mm 45° curved counter for height adjustable and recessed	78		
H740 mm 90° curved counter for height adjustable and recessed	79		
Square corner counter for height adjustable	80		
Triangular corner counter for height adjustable	81		
Middle panels	82		
Configurations	83		



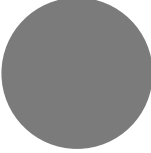
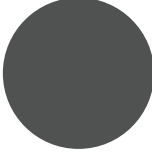

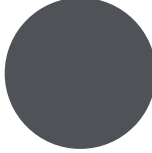
DESIGN OPTIONS

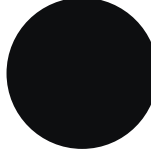
STEEL COMPONENTS - PAINTED

A PRICE GROUP - BASIS PRICE (smooth finish)

					
A03 Traffic white RAL 9016 Gloss 75-90	A02 Oyster white RAL 1013 Gloss 40-50	A22 Moss green RAL 6005 Gloss 71-85	A26 Fir green RAL 6009 Gloss 71-85	A12 Steel blue RAL 5011 Gloss 71-85	A13 Light grey RAL 7035 Gloss 71-85
					
A15 Dusty grey RAL 7037 Gloss 71-85	A16 Traffic grey RAL 7043 Gloss 71-85	A17 Basalt grey RAL 7012 Gloss 71-85	A18 Slate grey RAL 7015 Gloss 71-85	A19 Anthracite grey RAL 7016 Gloss 71-85	A25 Jet black RAL 9005 Gloss 71-85

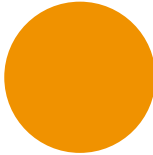
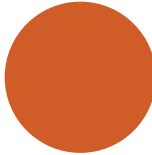
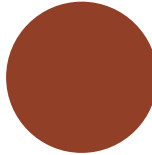
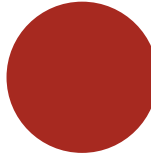
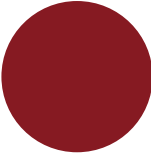
B PRICE GROUP - BASIS PRICE WITH 7% SURCHARGE (smooth finish)

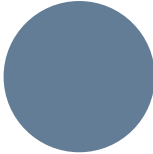
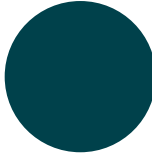
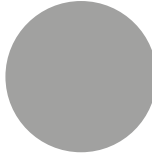
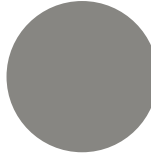
					
A01 Pure white RAL 9010 Gloss 71-85	A04 Traffic yellow RAL 1023 Gloss 71-85	A05 Sun yellow RAL 1037 Gloss 71-85	A06 Signal orange RAL 2010 Gloss 71-85	A07 Pearl orange RAL 2013 Gloss 65-85	A08 Flame red RAL 3000 Gloss 71-85
					
A09 Ruby red RAL 3003 Gloss 71-85	A21 Reseda green RAL 6011 Gloss 71-85	A10 Pigeon blue RAL 5014 Gloss 71-85	A11 Ocean blue RAL 5020 Gloss 71-85	A14 White aluminium RAL 9006 Gloss 50-70	A31 Grey aluminium RAL 9007 Gloss 50-70

B PRICE GROUP - BASIS PRICE WITH 7% SURCHARGE (textured finish)

				
A27 Pure white RAL 9010	A29 Concertina grey	A28 Grey aluminium RAL 9007	A23 Anthracite grey RAL 7016	A24 Graphite black RAL 9011

Note:

- Other RAL/NCS colours have a starter fee of GBP 215 / EUR 250 and a surcharge of 15%. A higher surcharge for colours with "metallic" look or different surface textures must be expected.
- See specific colour for steel gloss specification. Special requests outside specified gloss range are not covered by the above surcharges.

DESIGN OPTIONS

ACRYLIC COMPONENTS

A PRICE GROUP - BASIS PRICE

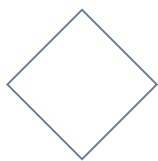

030
Crystal clear



046
Frost white



047
Arctic blue



048
Paprika red

Note:

- The acrylic front panels can be combined with acrylic side panels on shelving in the same colour. They can also be combined with lighting.

DESIGN OPTIONS

WOODEN COMPONENTS - MELAMINE/LAMINATE

A PRICE GROUP - BASIS PRICE

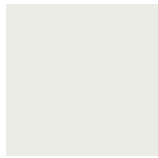

D61/L61
Signal white
RAL 9003



D72/L72
Oyster white
Similar to RAL 1013

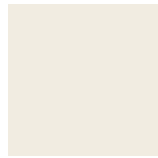

D62/L62
Pure white
Similar to RAL 9010



D63/L63
Steel blue
RAL 5011



D71/L71
Dusty grey
Similar to RAL 7037



D16/L16
Basalt grey
Similar to RAL 7012



D19/L19
Slate grey
Similar to RAL 7015 and RAL 7016



D04/L04
Beech decor



D05/L05
Maple decor

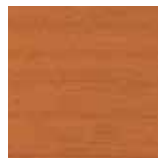

D06/L06
Cherry decor



D07/L07
Oak decor



D08/L08
Olive decor

C PRICE GROUP - BASIS PRICE WITH 10% SURCHARGE



D64/L64
Signal yellow
RAL 1003



D65/L65
Yellow orange
RAL 2000



D66/L66
Pure orange
RAL 2004



D67/L67
Traffic red
RAL 3020



E02/L02
Ruby red
Similar to RAL 3003



D13/L13
Lime green
Similar to NCS S1060-G40Y



D68/L68
Reseda green
Similar to RAL 6011



D14/L14
Crystal blue
Similar to NCS S1020-R90B



D73/L73
Pigeon blue
RAL 5014



D74/L74
Ocean blue
Similar to RAL 5020



D69/L69
Light grey
Similar to RAL 7035



D70/L70
White aluminium
Similar to RAL 9006



D75/L75
Jet black
Similar to RAL 9005

Note:

- The above selection of colours are shown in both melamine (D/Exx) and laminate (Lxx).
- If you order a product (e.g. Inform Search station) in two different colours from price group C, then please note that you will be charged two times the surcharge - one for each colour.

DESIGN OPTIONS

WOODEN COMPONENTS - VENEER

A PRICE GROUP - BASIS PRICE



55
Light steamed
beech



66
Oak



67
Maple



68
Ash



69
Birch

Note:

- Table and work surfaces with solid wood veneer only have limited abrasion resistance. We recommend using HPL (which has a special overlay). For these types of surfaces, due to its higher durability against damages and scratches. Do not use veneer surfaces. If veneer is used for counter tops, we do not accept any complaints for damages or scratches.



TECHNICAL SPECIFICATIONS

STEEL COMPONENTS

are powder coated with standard polyester based powders that secures high UV resistance. Powders comply with EN 45545 (fire protection - similar to DIN 4201). Thickness of the coating is 60-80 my.

The powder used includes:

- no triglycidylisocyanurate (TGIC)
- no heavy metal-containing pigments such as lead and cadmium
- no volatiles

Antibacterial equipping of surfaces upon request.

LEG FRAMES

are made of steel section 40 x 40 x 2 mm and 40 x 20 x 2 mm and finished with a powder coat of thermo hardened polyester powder or epoxy (depending on choice of colour). Note: a leg frame is required per counter top in the same counter height.

WOODEN COMPONENTS

are either melamine coated, high pressure laminated (HPL) or have a environmental-friendly transparent lacquered veneer finish. Differences in colour underline the characteristics of veneer and cannot be avoided. They are conform to the norm EN 13986 of material type P2 and must only be used indoors. The border on each wooden panel is finished with an edge of melamine or with an edge of ABS (radius 2 mm). The edges are in the same colour of the wooden panels.

SEARCH STATION AND DESK

are produced in 40 mm particle board and have a melamine/veneer finish.

COUNTERS, SIDE- & MIDDLE PANELS, BAG SHELVES AND COUNTER SHELVES

are produced in 40 mm particle board and have a HPL finish.

WOODEN CABINETS, COUNTER TOP PARTS AND DECORATIVE BOARDS

are produced in 19 mm particle board and have a melamine/veneer finish.

STRAIGHT WOODEN FRONT PANELS FOR COUNTERS AND COUNTER SHELVES

are produced in 19 mm particle board and have a melamine/veneer finish.

CURVED WOODEN FRONT PANELS FOR COUNTERS AND COUNTER SHELVES

are produced in 19 mm particle board and have a HPL finish.

PLINTH

is produced in 19 mm particle board and has a melamin aluminum finish.

ACRYLIC COMPONENTS

ACRYLIC FRONT PANELS

are made of 5 mm acrylic glass panel, known as Plexiglas XT®. This material is conform with the EU norm EN 13501-1 (classification D like the German's norm DIN 4102-1)

LIGHTING

LIGHTING FOR COUNTER

You can add light under the counter with the use of an acrylic front panel. This light is only for use indoors and is conform with the norm 60598-1 ed 2000 + A 11 ed. 2000, EN 60598-2-1 Ed. 1998.

CLEANING

Clean wooden-, metal- and acrylic surfaces with a damp cloth and wipe dry with a clean cloth. Use a water based cleaning agent. DO NOT USE A DETERGENT!

INFORM SEARCH STATION

SINGLE- AND DOUBLE-SIDED



INFORM SEARCH STATION

SINGLE- AND DOUBLE-SIDED

Search station with offset keyboard and monitor levels. Place the CPU in the lockable cabinet with sufficient ventilation provided by the recoiling base and the air and cable conduct. Place freestanding monitor on the top level, alternately install a console for flat-screen monitors. The back wall/door can be ordered in different colours compared to the top/side panels.

Inform search station - single-sided

Exterior: W750 x D625 x H1065 mm
Interior: W670 x D260 x H740 mm
With choice of desk grommet.

Material	Colour	Item no. Melamine	Price EUR	Item no. Veneer	Price EUR
Plastic	Black	BI610126	1.222,94	BI616122	2.014,15
Plastic	Oyster white	BI610186	1.254,06	BI616182	2.056,98
Plastic	Silver	BI610196	1.254,06	BI616192	2.056,98
Metal	Stainless steel	BI610136	1.301,14	BI616132	2.121,22

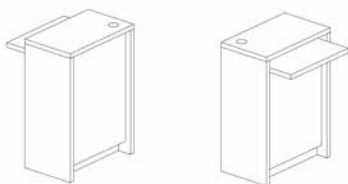

Inform search station - double-sided

Exterior: W750 x D1200 x H1065 mm
Interior: W670 x D610 x H740 mm

Material	Colour	Item no. Melamine	Price EUR	Item no. Veneer	Price EUR
Plastic	Black	BI610226	1.763,45	BI616222	2.904,45
Plastic	Oyster white	BI610286	1.794,70	BI616282	2.947,41
Plastic	Silver	BI610296	1.794,70	BI616292	2.947,41
Metal	Stainless steel	BI610236	1.841,52	BI616232	3.011,65



Console for flat-screen monitor

Lacquered steel. Incl. mounting kit.
Ideal for theft and tilt protection.

Item no.	Price EUR
B401418	265,60

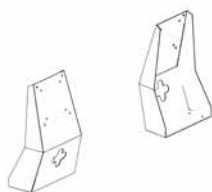

INFORM DESK

SOLO

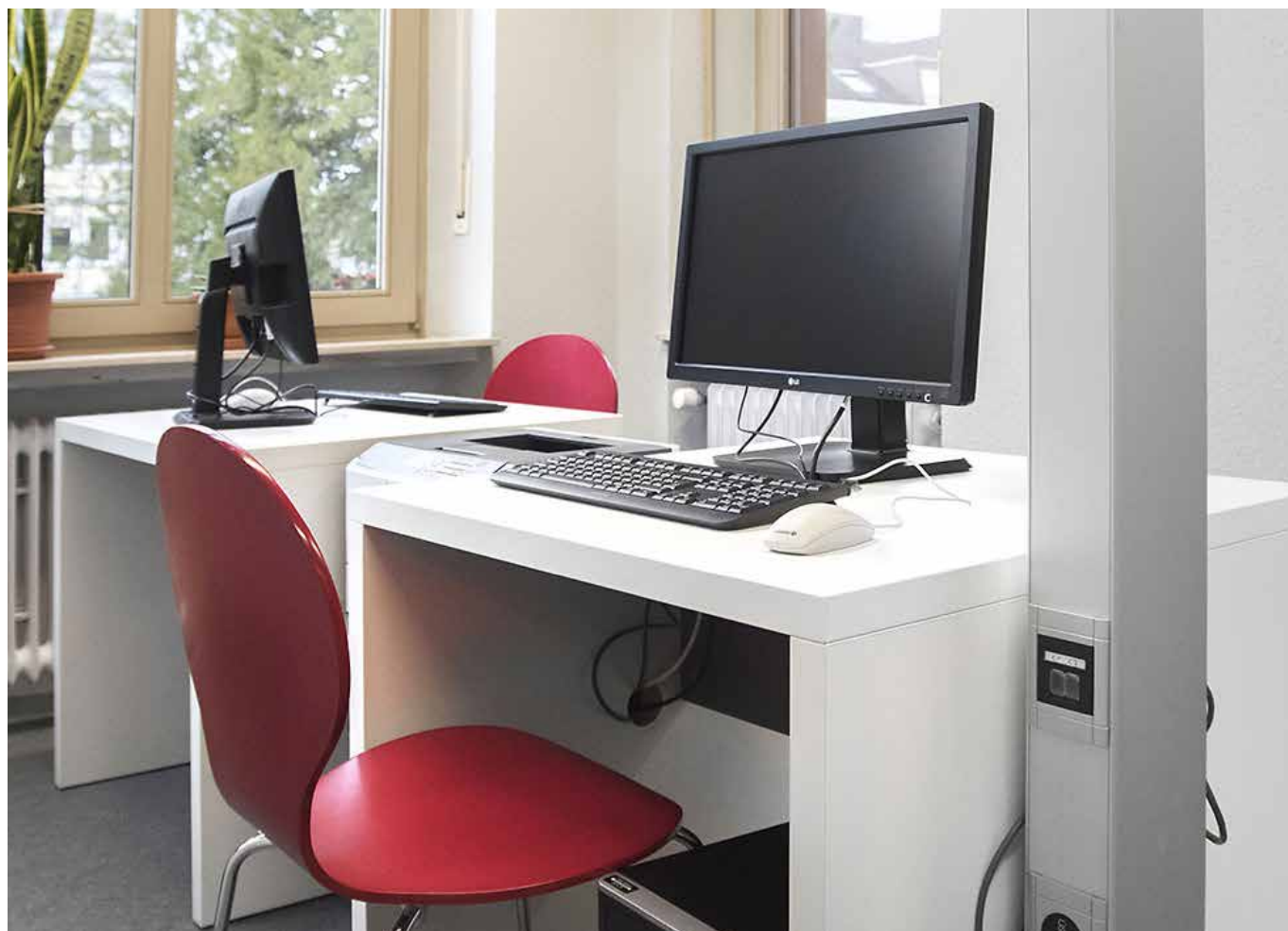

INFORM DESK

SOLO

Create a private workspace and work on your own with the Solo freestanding rectangular desk. For accessories, see page 113.

H740 mm - Rectangular table - freestanding - with panel (H305 mm) placed 50 mm from front

For counter with predrilled holes for cable conduct see pages 120-121.

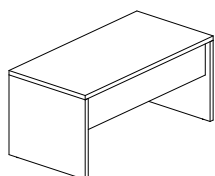

W x D mm	Item no. Melamine	Price EUR	Item no. Veneer	Price EUR
800 500	BI620104006	732,30	BI625104002	1.206,18
1000 500	BI620114006	787,49	BI625114002	1.297,15
1200 500	BI620124006	843,09	BI625124002	1.388,52
1400 500	BI620134006	897,62	BI625134002	1.478,43
1600 500	BI620144006	954,28	BI625144002	1.571,79
1800 500	BI620154006	1.001,62	BI625154002	1.649,73
800 600	BI620204006	766,88	BI625204002	1.263,10
1000 600	BI620214006	824,20	BI625214002	1.357,53
1200 600	BI620224006	881,66	BI625224002	1.452,09
1400 600	BI620234006	938,58	BI625234002	1.545,99
1600 600	BI620244006	997,37	BI625244002	1.642,68
1800 600	BI620254006	1.063,60	BI625254002	1.751,88
800 700	BI620304006	805,71	BI625304002	1.327,07
1000 700	BI620314006	866,10	BI625314002	1.426,56
1200 700	BI620324006	925,68	BI625324002	1.524,58
1400 700	BI620334006	983,67	BI625334002	1.620,34
1600 700	BI620344006	1.046,05	BI625344002	1.722,88
1800 700	BI620354006	1.113,74	BI625354002	1.834,47
800 800	BI620404006	842,82	BI625404002	1.388,12
1000 800	BI620414006	904,27	BI625414002	1.489,33
1200 800	BI620424006	966,51	BI625424002	1.592,01
1400 800	BI620434006	1.027,69	BI625434002	1.692,82
1600 800	BI620444006	1.091,80	BI625444002	1.798,29
1800 800	BI620454006	1.162,15	BI625454002	1.914,27

H1000 mm - Rectangular table - freestanding - with panel (H305 mm) placed 50 mm from front

For counter with predrilled holes for cable conduct see pages 120-121.

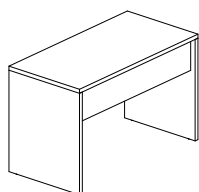

W x D mm	Item no. Melamine	Price EUR	Item no. Veneer	Price EUR
800 500	BI620106006	806,25	BI625106002	1.327,87
1000 500	BI620116006	861,31	BI625116002	1.418,71
1200 500	BI620126006	916,77	BI625126002	1.510,08
1400 500	BI620136006	971,30	BI625136002	1.599,86
1600 500	BI620146006	1.028,22	BI625146002	1.693,49
1800 500	BI620156006	1.092,46	BI625156002	1.799,49
800 600	BI620206006	845,61	BI625206002	1.392,78
1000 600	BI620216006	902,94	BI625216002	1.487,07
1200 600	BI620226006	960,26	BI625226002	1.581,64
1400 600	BI620236006	1.017,18	BI625236002	1.675,27
1600 600	BI620246006	1.076,10	BI625246002	1.772,49
1800 600	BI620256006	1.142,20	BI625256002	1.881,42
800 700	BI620306006	889,77	BI625306002	1.465,53
1000 700	BI620316006	950,15	BI625316002	1.565,01
1200 700	BI620326006	1.009,60	BI625326002	1.662,90
1400 700	BI620336006	1.067,86	BI625336002	1.758,79
1600 700	BI620346006	1.130,10	BI625346002	1.861,47
1800 700	BI620356006	1.197,93	BI625356002	1.973,06
800 800	BI620406006	932,06	BI625406002	1.535,22
1000 800	BI620416006	993,64	BI625416002	1.636,70
1200 800	BI620426006	1.055,75	BI625426002	1.738,84
1400 800	BI620436006	1.117,20	BI625436002	1.840,06
1600 800	BI620446006	1.181,17	BI625446002	1.945,39
1800 800	BI620456006	1.251,66	BI625456002	2.061,50

INFORM TABLE

DUO

Work opposite one another with the Duo freestanding, rectangular table. For accessories, see page 113.

H740 mm - Rectangular table - freestanding - with panel (H305 mm) in the centre of table top

For counter with predrilled holes for cable conduct see pages 120-121.

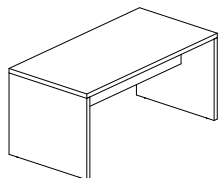

W x D mm	Item no. Melamine	Price EUR	Item no. Veneer	Price EUR
800 x 800	BI630404006	842,82	BI635404002	1.388,12
1000 x 800	BI630414006	904,27	BI635414002	1.489,33
1200 x 800	BI630424006	966,51	BI635424002	1.592,01
1400 x 800	BI630434006	1.027,69	BI635434002	1.692,82
1600 x 800	BI630444006	1.091,80	BI635444002	1.798,29
1800 x 800	BI630454006	1.162,15	BI635454002	1.914,27
800 x 1000	BI630504006	917,30	BI635504002	1.510,88
1000 x 1000	BI630514006	986,99	BI635514002	1.625,66
1200 x 1000	BI630524006	1.052,03	BI635524002	1.732,72
1400 x 1000	BI630534006	1.117,47	BI635534002	1.840,59
1000 x 1000	BI630544006	1.187,69	BI635544002	1.956,16
1800 x 1000	BI630554006	1.234,51	BI635554002	2.033,44
800 x 1200	BI630604006	1.025,56	BI635604002	1.689,23
1000 x 1200	BI630614006	1.084,62	BI635614002	1.786,46
1200 x 1200	BI630624006	1.189,42	BI635624002	1.959,09
1400 x 1200	BI630634006	1.246,34	BI635634002	2.052,72
1600 x 1200	BI630644006	1.304,33	BI635644002	2.148,35
1800 x 1200	BI630654006	1.387,59	BI635654002	2.285,61
800 x 1400	BI630704006	1.091,80	BI635704002	1.798,29
1000 x 1400	BI630714006	1.204,32	BI635714002	1.983,56
1200 x 1400	BI630724006	1.266,69	BI635724002	2.086,37
1400 x 1400	BI630734006	1.422,70	BI635734002	2.343,33
1600 x 1400	BI630744006	1.486,54	BI635744002	2.448,40
1800 x 1400	BI630754006	1.560,09	BI635754002	2.569,69
800 x 1600	BI630804006	1.157,63	BI635804002	1.906,82
1000 x 1600	BI630814006	1.276,00	BI635814002	2.101,67
1200 x 1600	BI630824006	1.343,83	BI635824002	2.213,52
1400 x 1600	BI630834006	1.505,29	BI635834002	2.479,39
1600 x 1600	BI630844006	1.574,45	BI635844002	2.593,23
1800 x 1600	BI630854006	1.653,72	BI635854002	2.723,84

INFORM TABLE

DUO

Work opposite one another with the Duo freestanding, rectangular table. For accessories, see page 113.

H1000 mm - Rectangular table - freestanding - with panel (H305 mm) in the centre of table top

For counter with predrilled holes for cable conduct see pages 120-121.

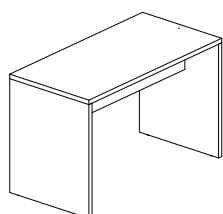

W x D mm	Item no. Melamine	Price EUR	Item no. Veneer	Price EUR
800 x 800	BI630406006	932,06	BI635406002	1.535,22
1000 x 800	BI630416006	993,64	BI635416002	1.636,70
1200 x 800	BI630426006	1.055,75	BI635426002	1.738,84
1400 x 800	BI630436006	1.117,20	BI635436002	1.840,06
1600 x 800	BI630446006	1.181,17	BI635446002	1.945,39
1800 x 800	BI630456006	1.251,66	BI635456002	2.061,50
800 x 1000	BI630506006	1.002,95	BI635506002	1.651,99
1000 x 1000	BI630516006	1.072,51	BI635516002	1.766,51
1200 x 1000	BI630526006	1.137,82	BI635526002	1.873,97
1400 x 1000	BI630536006	1.203,12	BI635536002	1.981,57
1600 x 1000	BI630546006	1.273,34	BI635546002	2.097,28
1800 x 1000	BI630556006	1.320,16	BI635556002	2.174,42
800 x 1200	BI630606006	1.116,00	BI635606002	1.838,06
1000 x 1200	BI630616006	1.174,92	BI635616002	1.935,28
1200 x 1200	BI630626006	1.279,99	BI635626002	2.108,18
1400 x 1200	BI630636006	1.336,52	BI635636002	2.201,42
1600 x 1200	BI630646006	1.394,77	BI635646002	2.297,31
1800 x 1200	BI630656006	1.478,03	BI635656002	2.434,43
800 x 1400	BI630706006	1.196,60	BI635706002	1.971,06
1000 x 1400	BI630716006	1.309,12	BI635716002	2.156,33
1200 x 1400	BI630726006	1.371,63	BI635726002	2.259,14
1400 x 1400	BI630736006	1.527,37	BI635736002	2.515,70
1600 x 1400	BI630746006	1.591,21	BI635746002	2.620,90
1800 x 1400	BI630756006	1.664,63	BI635756002	2.741,93
800 x 1600	BI630806006	1.306,99	BI635806002	2.152,74
1000 x 1600	BI630816006	1.424,83	BI635816002	2.346,92
1200 x 1600	BI630826006	1.492,93	BI635826002	2.458,90
1400 x 1600	BI630836006	1.654,39	BI635836002	2.725,04
1600 x 1600	BI630846006	1.723,55	BI635846002	2.838,89
1800 x 1600	BI630856006	1.802,82	BI635856002	2.969,36

INFORM TABLE

DUO & TWIN



INFORM TABLE

TWIN

Work or play? Create a fun and interesting - yet functional - sitting or standing area in the library with the Inform curved desk. For accessories, see page 113.

H740 mm - 2 x 90° curved tables - freestanding - with panel (H305 mm) in the centre of table top

Total length 3250 mm, total depth 1122 mm. For counter with predrilled holes for cable conduct see pages 120-121.

D mm	Item no. Melamine	Price EUR	Item no. Veneer	Price EUR
800	BI64044006	2.909,38	BI64544002	4.792,26

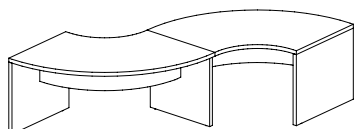

H1000 mm - 2 x 90° curved tables - freestanding - with panel (H305 mm) in the centre of table top

Total length 3250 mm, total depth 1122 mm. For counter with predrilled holes for cable conduct see pages 120-121.

D mm	Item no. Melamine	Price EUR	Item no. Veneer	Price EUR
800	BI64046006	3.016,71	BI64546002	4.968,75

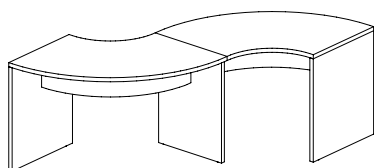

INFORM COUNTER

Inform is a modular piece of furniture. Straight and curved elements can be used as freestanding counters or randomly combined. The special design of the table tops and side panels creates a continuous surrounding frame which unites the single elements into an expressive optical unit.

Inform's modular construction allows an individual adaptation to functional and design requirements, as well as to architectural conditions. You are able to reconstruct and add on as well as electrically adjust the counter to your ideal working height. Modules in the two heights; 740 and 1000 mm can be combined in many ways. The counter is also suitable for use with RFID systems.

CONSTRUCTION

The construction of the counter Inform is based on a left-to-right sequence (seen from the person's view sitting behind the counter). The counter has 15 mm adjustable feet.

MOUNTING TOLERANCES

All our components for the Inform counter are produced according to the norm DIN ISO 2768-1.

ASSEMBLY

No special fittings or tools are needed.

DIMENSIONS

For planning purposes, please note the below measurements. The listed measurements in the catalogue/price list are the effective measurements for the front panels only. It is necessary to add 40 mm with all the side/end panels, step counter middle panels and middle panels in connection with height adjustable counters.

STARTER-, MIDDLE- & END ELEMENT

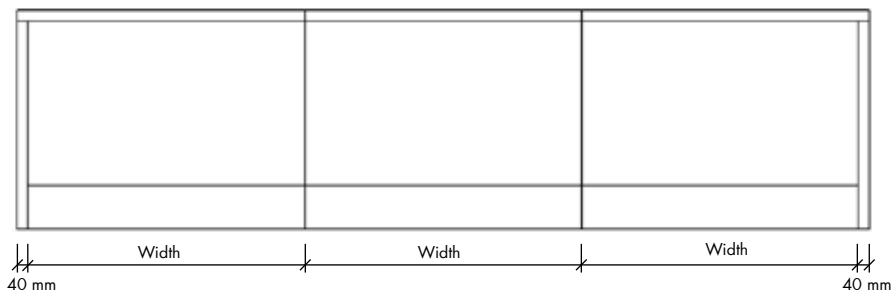

STEP COUNTER

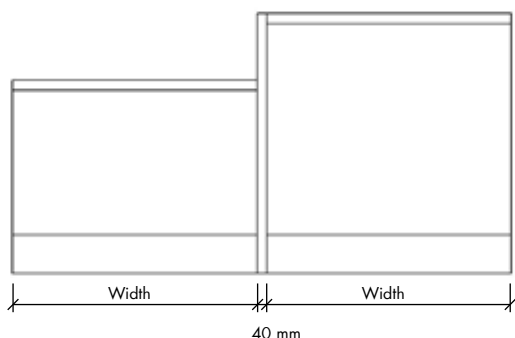

HEIGHT ADJUSTABLE COUNTER

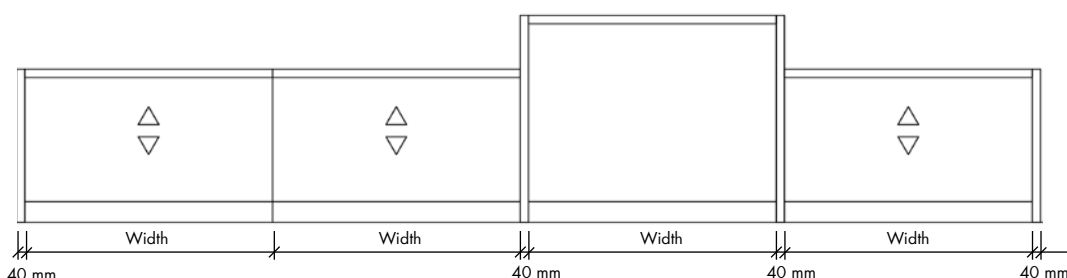

CONFIGURATION OPTIONS

RECTANGULAR COUNTERS

W 600/800/1000/1200/1400/1600 mm (+40 mm per outer panel)
 H 740/1000 mm
 D 800 mm

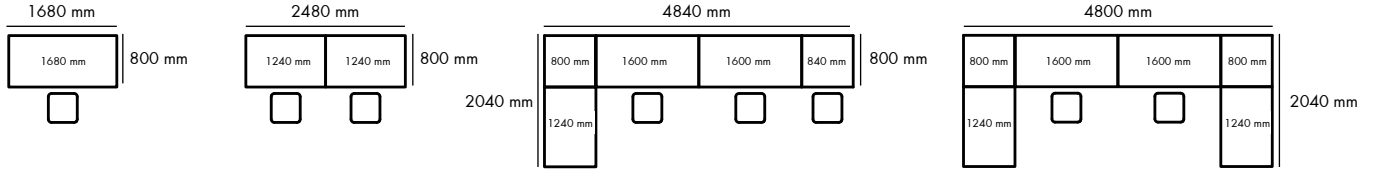

CURVED COUNTERS 45° & 90°

Height:	740 mm	Height:	740 mm
Inside radius:	1550 mm	Inside radius:	500 mm
Outer radius:	2350 mm	Outer radius:	1300 mm

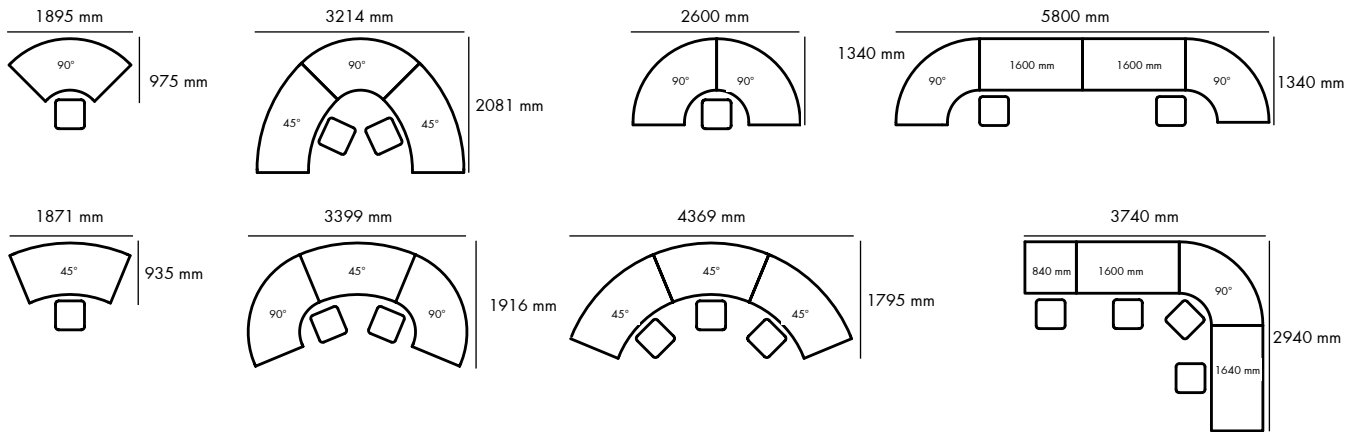

RECTANGULAR AND CURVED COUNTERS WITH VARIOUS INTEGRATED CABINETS/COUNTERS

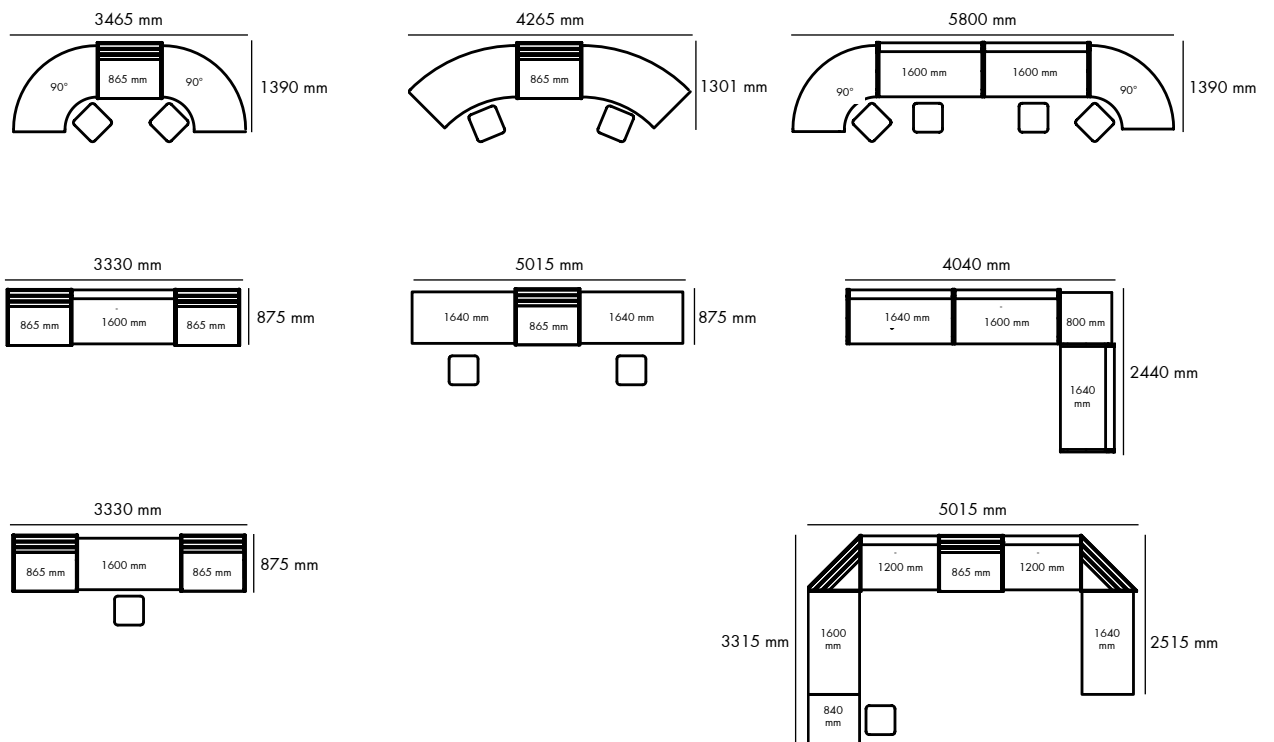

STANDARD COUNTER

CONFIGURATION NO. 1

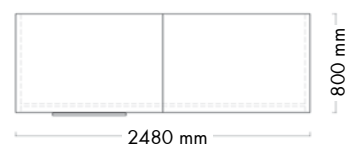

Rectangular counter (with info sign)

Components	Article no.	Price EUR	Quantity	EUR
Rectangular counter - starter (W1240 x H740 mm)	BI2001022003	797,34	1	797,34
Rectangular counter - end (W1240 x H740 mm)	BI2003022003	797,34	1	797,34
Wooden front panel for rectangular counter (W1200 x H740 mm)	BI300546	314,94	2	629,88
Steel leg frame (H740 mm)	BI069146	379,72	1	379,72
Info sign - acrylic frosted white glazed (W600 x H430 mm)	BI85512	336,89	1	336,89
Monitor arm	B401184	845,08	1	845,08
Total price for configuration				3.786,25

Comments to configuration

- Monitor, office chair and text are not included in price.
- All prices are based on colours and surfaces in price group A, see pages 4-7 for colours.
- We recommend the use of desk grommets, cable rails and drawer pedestals with the Inform counter, see page 113.
- It is necessary to drill an Ø80 mm hole for the monitor arm on site or modify the article number for counter for predrilled hole, see pages 120-121.

STANDARD COUNTER

CONFIGURATION NO. 2

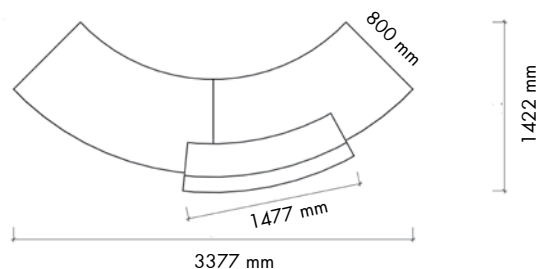

45° curved counters (with counter top part with bag shelf)

Components	Article no.	Price EUR	Quantity	EUR
45° curved counter - starter (H740 mm)	BI2051428003	1.229,32	1	1.229,32
45° curved counter - end (H740 mm)	BI2053428003	1.229,32	1	1.229,32
Wooden front panel for 45° curved counter (H740 mm)	BI3204543	2.104,06	2	4.208,12
Steel leg frame (H740 mm)	BI069146	379,72	1	379,72
Wooden counter top part with bag shelf (W1400 x H490 mm)	BI83545683	1.758,93	1	1.758,93
Total price for configuration				8.805,41

Comments to configuration

- Computer, office chair and text are not included in price.
- All prices are based on colours and surfaces in price group A, see pages 4-7 for colours.
- We recommend the use of desk grommets, cable rails and drawer pedestals with the Inform counter, see page 113.

STANDARD COUNTER

RECTANGULAR COUNTER

Inform's rectangular modules are available in two heights; 740 and 1000 mm. This model can be combined with other standard counters of the same height, step counters, height adjustable counters (only with H1000 mm standard counter), info counters, corner counters as well as display cabinets.

Rectangular counter - starter

Remember to order front panel, see page 23 and leg frame/middle panel, see page 34. For counter with predrilled holes for cable conduct see pages 120-121.

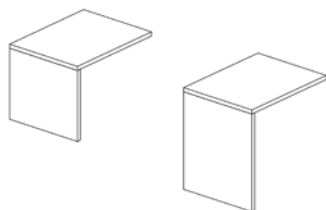

H x W x D mm	Item no. HPL	Price EUR
740 640 800	BI2001016003	677,37
740 840 800	BI2001018003	701,31
740 1040 800	BI2001020003	749,32
740 1240 800	BI2001022003	797,34
740 1440 800	BI2001024003	857,05
740 1640 800	BI2001026003	893,23
1000 640 800	BI2001036003	724,05
1000 840 800	BI2001038003	747,99
1000 1040 800	BI2001040003	796,01
1000 1240 800	BI2001042003	844,02
1000 1440 800	BI2001044003	903,87
1000 1640 800	BI2001046003	939,91

Rectangular counter - middle

Remember to order front panel, see page 23 and leg frame/middle panel, see page 34. For counter with predrilled holes for cable conduct see pages 120-121.

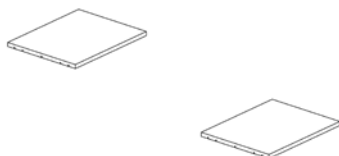

W x D mm	Item no. HPL	Price EUR
600 800	BI2002060003	377,19
800 800	BI2002080003	422,67
1000 800	BI2002081003	449,41
1200 800	BI2002082003	497,42
1400 800	BI2002084003	557,94
1600 800	BI2002086003	593,18

Rectangular counter - end

Remember to order front panel, see page 23 and leg frame/middle panel, see page 34. For counter with predrilled holes for cable conduct see pages 120-121.

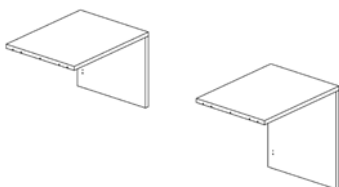

H x W x D mm	Item no. HPL	Price EUR
740 640 800	BI2003016003	677,37
740 840 800	BI2003018003	701,31
740 1040 800	BI2003020003	749,32
740 1240 800	BI2003022003	797,34
740 1440 800	BI2003024003	857,05
740 1640 800	BI2003026003	893,23
1000 640 800	BI2003036003	724,05
1000 840 800	BI2003038003	747,99
1000 1040 800	BI2003040003	796,01
1000 1240 800	BI2003042003	844,02
1000 1440 800	BI2003044003	903,87
1000 1640 800	BI2003046003	939,91

STANDARD COUNTER

FREESTANDING RECTANGULAR COUNTER AND FRONT PANELS

A freestanding rectangular counter is an ideal solution for small rooms and is available in two heights; 740 and 1000 mm. Remember to order front panels.

Rectangular counter - freestanding

Remember to order front panel. For counter with predrilled holes for cable conduct see pages 120-121.

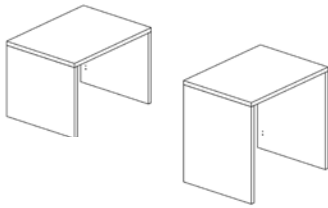

H x W x D mm	Item no. HPL	Price EUR
740 680 800	BI2004016003	1.001,49
740 880 800	BI2004018003	1.025,30
740 1080 800	BI2004020003	1.073,31
740 1280 800	BI2004022003	1.121,19
740 1480 800	BI2004024003	1.181,17
740 1680 800	BI2004026003	1.217,35
1000 680 800	BI2004036003	1.094,72
1000 880 800	BI2004038003	1.118,66
1000 1080 800	BI2004040003	1.166,68
1000 1280 800	BI2004042003	1.214,69
1000 1480 800	BI2004044003	1.274,54
1000 1680 800	BI2004046003	1.310,45

Wooden front panel for rectangular counter

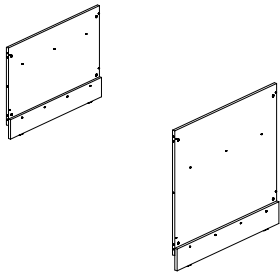

H x W mm	Item no. Melamine	Price EUR	Item no. Veneer	Price EUR
740 600	BI300146	205,22	BI300142	337,95
740 800	BI300346	235,81	BI300342	388,89
740 1000	BI300446	283,96	BI300442	467,76
740 1200	BI300546	314,94	BI300542	518,70
740 1400	BI300646	348,86	BI300642	574,29
740 1600	BI300746	401,66	BI300742	661,28
1000 600	BI300166	360,16	BI300162	593,18
1000 800	BI300366	367,21	BI300362	604,75
1000 1000	BI300466	471,75	BI300462	776,72
1000 1200	BI300566	486,91	BI300562	802,12
1000 1400	BI300666	491,70	BI300662	810,24
1000 1600	BI300766	496,62	BI300762	817,95

Acrylic front panel for rectangular counter

Melamine coated wooden frame.

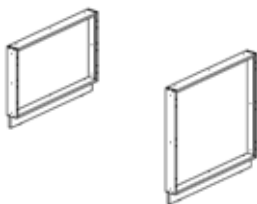

H x W mm	Item no. Acrylic & melamine	Price EUR
740 600	BI310146	770,07
740 800	BI310346	792,95
740 1000	BI310446	886,71
740 1200	BI310546	933,13
740 1400	BI310646	1.003,09
740 1600	BI310746	1.071,18
1000 600	BI310166	895,62
1000 800	BI310366	919,30
1000 1000	BI310466	1.012,53
1000 1200	BI310566	1.059,08
1000 1400	BI310666	1.129,04
1000 1600	BI310766	1.197,00

STANDARD COUNTER

45° CURVED COUNTERS

Inform's 45° curved modules are available in two heights; 740 and 1000 mm. This model can be combined with other standard counters of the same height, step counters, height adjustable counters (only with H1000 mm standard counter), info counters, corner counters as well as display cabinets.

45° curved counter - starter

Remember to order front panel, see page 25 and leg frame/middle panel, see page 34. For counter with predrilled holes for cable conduct see pages 120-121.

H	W	D
mm		
740	1835	800
1000	1835	800

Item no. HPL	Price EUR
BI2051428003	1.229,32
BI2051448003	1.276,14

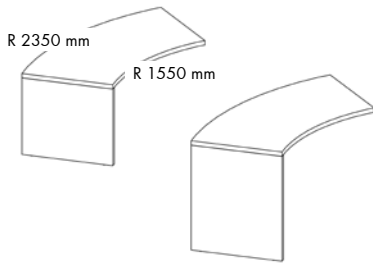

45° curved counter - middle

Remember to order front panel, see page 25 and leg frame/middle panel, see page 34. For counter with predrilled holes for cable conduct see pages 120-121.

W	D
mm	
1800	800

Item no. HPL	Price EUR
BI2052488003	905,46



45° curved counter - end

Remember to order front panel, see page 25 and leg frame/middle panel, see page 34. For counter with predrilled holes for cable conduct see pages 120-121.

H	W	D
mm		
740	1835	800
1000	1835	800

Item no. HPL	Price EUR
BI2053428003	1.229,32
BI2053448003	1.276,14

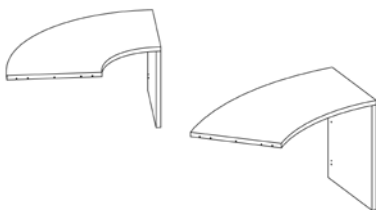

STANDARD COUNTER

FREESTANDING 45° CURVED COUNTERS AND FRONT PANELS

A freestanding 45° curved counter is an ideal solution for small rooms and is available in two heights; 740 and 1000 mm. Remember to order front panels.

45° curved counter - freestanding

Remember to order front panel. For counter with predrilled holes for cable conduct see pages 120-121.

H x W x D mm	Item no. HPL	Price EUR
740 1870 800	BI2054428003	1.553,31
1000 1870 800	BI2054448003	1.646,67

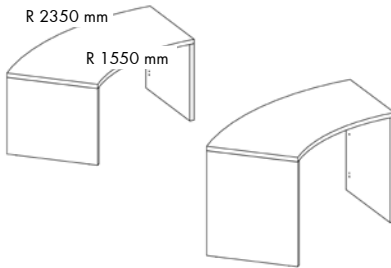

Wooden front panel for 45° curved counter

H x W mm	Item no. HPL	Price EUR
740 1760	BI3204543	2.104,06
1000 1760	BI3204563	2.460,90

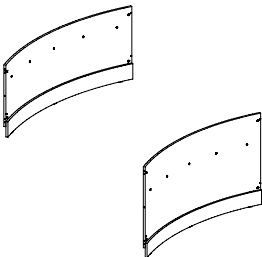

Acrylic front panel for 45° curved counter

Melaminecoated wooden frame.

H x W mm	Item no. Acrylic & melamine	Price EUR
740 1760	BI3304546	1.509,68
1000 1760	BI3304566	1.611,69

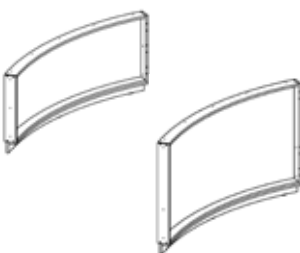

STANDARD COUNTER

90° CURVED COUNTERS

Inform's 90° curved modules are available in two heights; 740 and 1000 mm. This model can be combined with other standard counters of the same height, step counters, height adjustable counters (only with H1000 mm standard counter), info counters, corner counters as well as display cabinets.

90° curved counter - starter

Remember to order front panel, see page 27 and leg frame/middle panel, see page 34. For counter with predrilled holes for cable conduct see pages 120-121.

H	x	W	x	D
mm				
740	1870	800		
1000	1870	800		

Item no. HPL	Price EUR
BI2051928003	1.325,48
BI2051948003	1.372,16

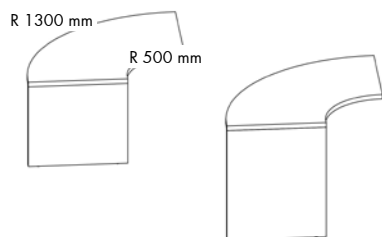

90° curved counter - middle

Remember to order front panel, see page 27 and leg frame/middle panel, see page 34. For counter with predrilled holes for cable conduct see pages 120-121.

W	x	D
mm		
1800	800	

Item no. HPL	Price EUR
BI2052988003	1.001,62



90° curved counter - end

Remember to order front panel, see page 27 and leg frame/middle panel, see page 34. For counter with predrilled holes for cable conduct see pages 120-121.

H	x	W	x	D
mm				
740	1870	800		
1000	1870	800		

Item no. HPL	Price EUR
BI2053928003	1.325,48
BI2053948003	1.372,16

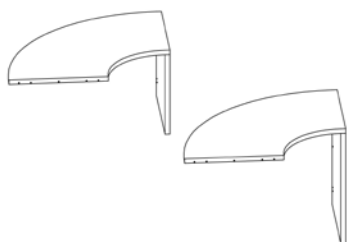

STANDARD COUNTERS

FREESTANDING 90° CURVED COUNTERS AND FRONT PANELS

A freestanding 90° curved counter is an ideal solution for small rooms and is available in two heights; 740 and 1000 mm. Remember to order front panels.

90° curved counter - freestanding

Remember to order front panel. For counter with predrilled holes for cable conduct see pages 120-121.

H	x	W	x	D
mm				
740		1900		800
1000		1900		800

Item no.	Price
HPL	EUR
BI2054928003	1.649,60
BI2054948003	1.742,70

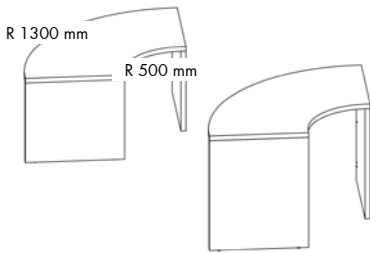

Wooden front panel for 90° curved counter

H	x	W
mm		
740		1768
1000		1768

Item no.	Price
HPL	EUR
BI3209043	2.139,57
BI3209063	2.235,20

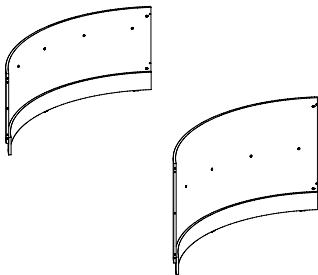

Acrylic front panel for 90° curved counter

Melaminecoated wooden frame.

H	x	W
mm		
740		1768
1000		1768

Item no.	Price
Acrylic & melamine	EUR
BI3309046	1.947,79
BI3309066	2.074,00

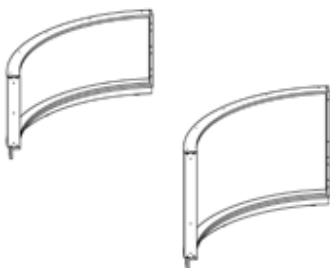

STANDARD COUNTER

RECTANGULAR COUNTERS - FOR CONNECTING TO RECESSED COUNTER

Inform's rectangular modules are available in two heights; 740 and 1000 mm. This model can be combined with recessed counters of the same height as the standard counter by connecting with a middle panel (as the counter top is 40 mm wider than the standard rectangular counter).

Rectangular counter - starter - connected with middle panel

Remember to order front panel, see page 29 and middle panel, see page 34. For counter with predrilled holes for cable conduct see pages 120-121.

H	x	W	x	D
mm				
740	680	800		
740	880	800		
740	1080	800		
740	1280	800		
740	1480	800		
740	1680	800		
1000	680	800		
1000	880	800		
1000	1080	800		
1000	1280	800		
1000	1480	800		
1000	1680	800		

Item no. HPL	Price EUR
BI2021016003	677,37
BI2021018003	701,31
BI2021020003	749,32
BI2021022003	797,34
BI2021024003	857,05
BI2021026003	893,23
BI2021036003	724,05
BI2021038003	747,99
BI2021040003	796,01
BI2021042003	844,02
BI2021044003	903,87
BI2021046003	939,91

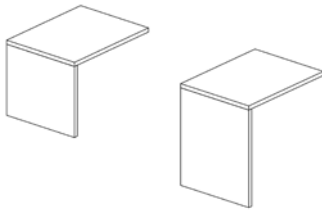

Rectangular counter - middle - connected with middle panel

Remember to order front panel, see page 29 and middle panel, see page 34. For counter with predrilled holes for cable conduct see pages 120-121.

W	x	D
mm		
640	800	
840	800	
1040	800	
1240	800	
1440	800	
1640	800	

Item no. HPL	Price EUR
BI2022060003	377,19
BI2022080003	422,67
BI2022081003	449,41
BI2022082003	497,42
BI2022084003	557,94
BI2022086003	593,18

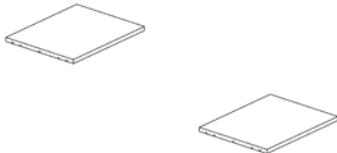

Rectangular counter - end - connected with middle panel

Remember to order front panel, see page 29 and middle panel, see page 34. For counter with predrilled holes for cable conduct see pages 120-121.

H	x	W	x	D
mm				
740	680	800		
740	880	800		
740	1080	800		
740	1280	800		
740	1480	800		
740	1680	800		
1000	680	800		
1000	880	800		
1000	1080	800		
1000	1280	800		
1000	1480	800		
1000	1680	800		

Item no. HPL	Price EUR
BI2023016003	677,37
BI2023018003	701,31
BI2023020003	749,32
BI2023022003	797,34
BI2023024003	857,05
BI2023026003	893,23
BI2023036003	724,05
BI2023038003	747,99
BI2023040003	796,01
BI2023042003	844,02
BI2023044003	903,87
BI2023046003	939,91

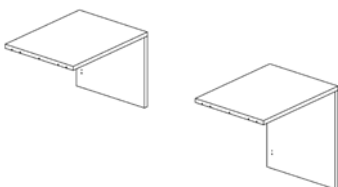

STANDARD COUNTER

RECTANGULAR FRONT PANELS

Remember to order front panels.

Wooden front panel for rectangular counter

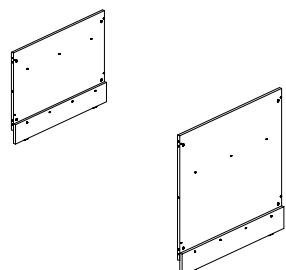
		H x W mm	Item no. Melamine	Price EUR	Item no. Veneer	Price EUR
		740 600	BI300146	205,22	BI300142	337,95
		740 800	BI300346	235,81	BI300342	388,89
		740 1000	BI300446	283,96	BI300442	467,76
		740 1200	BI300546	314,94	BI300542	518,70
		740 1400	BI300646	348,86	BI300642	574,29
		740 1600	BI300746	401,66	BI300742	661,28
		1000 600	BI300166	360,16	BI300162	593,18
		1000 800	BI300366	367,21	BI300362	604,75
		1000 1000	BI300466	471,75	BI300462	776,72
		1000 1200	BI300566	486,91	BI300562	802,12
		1000 1400	BI300666	491,70	BI300662	810,24
		1000 1600	BI300766	496,62	BI300762	817,95

Acrylic front panel for rectangular counter

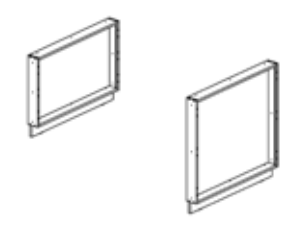
Melaminecoated wooden frame.	H x W mm	Item no. Acrylic & Melamine	Price EUR
	740 600	BI310146	770,07
	740 800	BI310346	792,95
	740 1000	BI310446	886,71
	740 1200	BI310546	933,13
	740 1400	BI310646	1.003,09
	740 1600	BI310746	1.071,18
	1000 600	BI310166	895,62
	1000 800	BI310366	919,30
	1000 1000	BI310466	1.012,53
	1000 1200	BI310566	1.059,08
	1000 1400	BI310666	1.129,04
	1000 1600	BI310766	1.197,00

STANDARD COUNTER

45° CURVED COUNTERS - FOR CONNECTING TO RECESSED COUNTER

Inform's° curved modules are available in two heights; 740 and 1000 mm. This model can be combined with recessed counters of the same height as the standard counter by connecting with a middle panel (as the counter top is 40 mm wider than the standard 45° curved counter).

45° curved counter - starter - connected with middle panel

Remember to order front panel, see page 31 and middle panel, see page 34. For counter with predrilled holes for cable conduct see pages 120-121.

H	x	W	x	D
mm				
740	-	800		
1000	-	800		

Item no. HPL	Price EUR
BI2061428003	1.229,32
BI2061448003	1.276,14

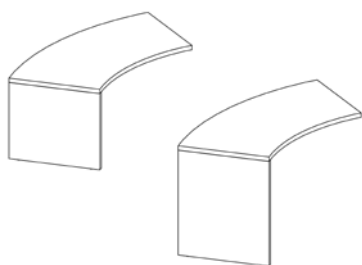

45° curved counter - end - for middle panel

Remember to order front panel, see page 31 and middle panel, see page 34. For counter with predrilled holes for cable conduct see pages 120-121.

H	x	W	x	D
mm				
740	-	800		
1000	-	800		

Item no. HPL	Price EUR
BI2063428003	1.229,32
BI2063448003	1.276,14

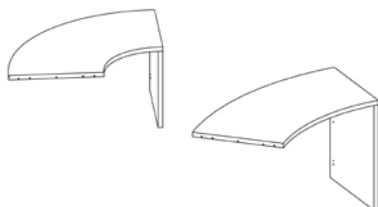

STANDARD COUNTER



45° CURVED FRONT PANELS

Remember to order front panels.

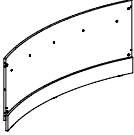
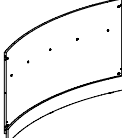
Wooden front panel for 45° curved counter

	H x W mm	Item no. HPL	Price EUR
	740 1760	BI3204543	2.104,06
	1000 1760	BI3204563	2.460,90

Acrylic front panel for 45° curved counter

Melaminecoated wooden frame.	H x W mm	Item no. Acrylic & melamine	Price EUR
	740 1760	BI3304546	1.509,68
	1000 1760	BI3304566	1.611,69

STANDARD COUNTER

90° CURVED COUNTERS - FOR CONNECTING TO RECESSED COUNTER

Inform's 90° curved modules are available in two heights; 740 and 1000 mm. This model can be combined with recessed counters of the same height as the standard counter by connecting with a middle panel (as the counter top is 40 mm wider than the standard 90° curved counter).

90° curved counter - starter - connected with middle panel

Remember to order front panel, see page 33 and middle panel, see page 34. For counter with predrilled holes for cable conduct see pages 120-121.

H	x	W	x	D
mm				
740	-	800		
1000	-	800		

Item no. HPL	Price EUR
BI2061928003	1.325,48
BI2061948003	1.372,16

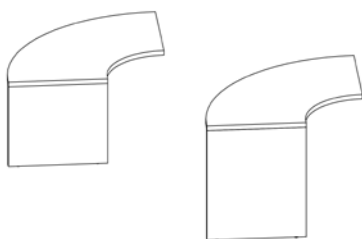

90° curved counter - end - connected with middle panel

Remember to order front panel, see page 33 and middle panel, see page 34. For counter with predrilled holes for cable conduct see pages 120-121.

H	x	W	x	D
mm				
740	-	800		
1000	-	800		

Item no. HPL	Price EUR
BI2063928003	1.325,48
BI2063948003	1.372,16

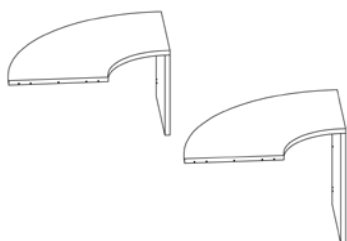

STANDARD COUNTERS



90° CURVED FRONT PANELS

Remember to order front panels.

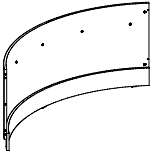
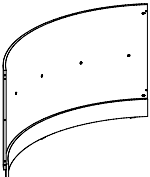
Wooden front panel for 90° curved counter

	H x W mm	Item no. HPL	Price EUR
	740 1768	BI3209043	2.139,57
	1000 1768	BI3209063	2.235,20

Acrylic front panel for 90° curved counter

Melaminecoated wooden frame.	H x W mm	Item no. Acrylic & melamine	Price EUR
	740 1768	BI3309046	1.947,79
	1000 1768	BI3309066	2.074,00

STANDARD COUNTER

CONNECTIONS

If you wish to combine a rectangular/curved counter with a rectangular/curved counter of the same height, you must use a steel leg frame.

If you wish to combine a rectangular/curved counter with recessed rectangular/curved or step counter, you must use a middle panel.

Steel leg frame

Must be used when assembling 2 modules of the same height.

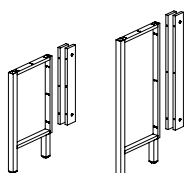

Finish	H mm	Item no. Melamine/veneer	Price EUR
Melamine	740	BI069146	379,72
	1000	BI069166	423,47
Veneer	740	BI069142	625,37
	1000	BI069162	697,45

Middle panel for standard and recessed counter

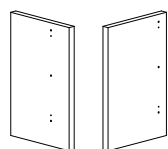

Side of panel	H mm	Item no. HPL	Price EUR
Left : Recessed counter Right: Standard counter	740	BI3704103	170,37

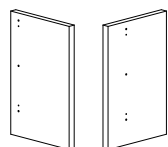

Left: Standard counter Right: Recessed counter	740	BI3704113	170,37
---	-----	-----------	--------

Middle panel for standard and step counter

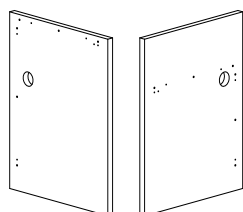

Side of panel	H mm	Item no. HPL	Price EUR
Left: Step counter Right: Standard counter (H740 mm)	1000	BI3706123	348,46

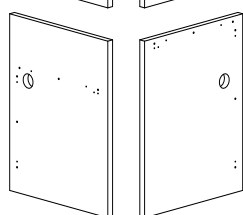

Left: Standard counter (H740 mm) Right: Step counter	1000	BI3706133	348,46
---	------	-----------	--------

STANDARD COUNTER

CONFIGURATIONS

Remember always to construct your counter from left to right when sitting behind the counter.

Standard rectangular counter with 3 standard fronts and 1 recessed front

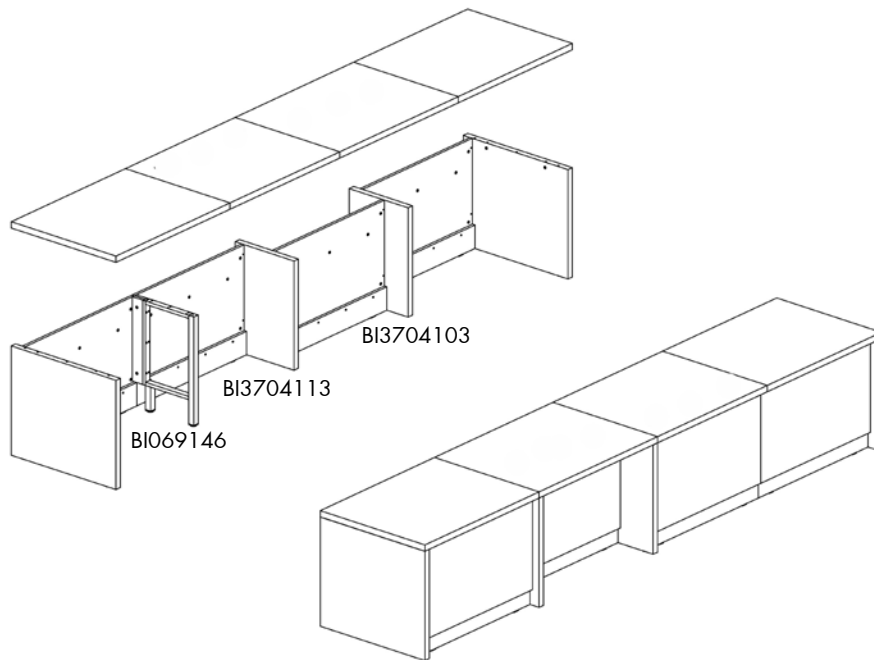

Standard rectangular and step counters

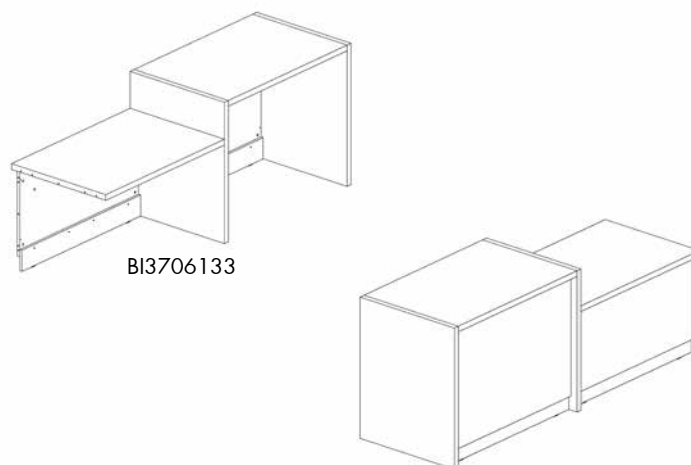

RECESSED COUNTER

CONFIGURATION NO. 3

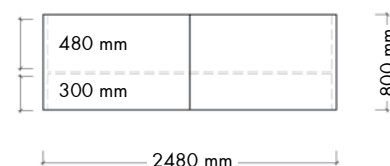

Recessed rectangular counter

Components	Article no.	Price EUR	Quantity	EUR
Recessed rectangular counter - starter (W1240 x H740 mm)	BI2101022003	797,34	1	797,34
Recessed rectangular counter - end (W1240 x H740 mm)	BI2103022003	797,34	1	797,34
Wooden front panel for rectangular counter (W1200 x H740 mm)	BI300546	314,94	2	629,88
Steel leg frame for recessed counter (H740 mm)	BI069546	396,21	1	396,21
Total price for configuration				2.620,77

Comments to configuration

- Monitor, office chair and text are not included in price.
- All prices are based on colours and surfaces in price group A, see pages 4-7 for colours.
- We recommend the use of desk grommets, cable rails and drawer pedestals with the Inform counter, see page 113.

RECESSED COUNTER

CONFIGURATION NO. 4

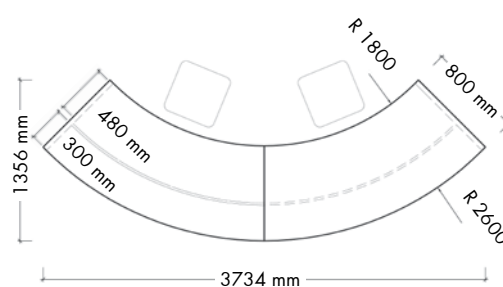
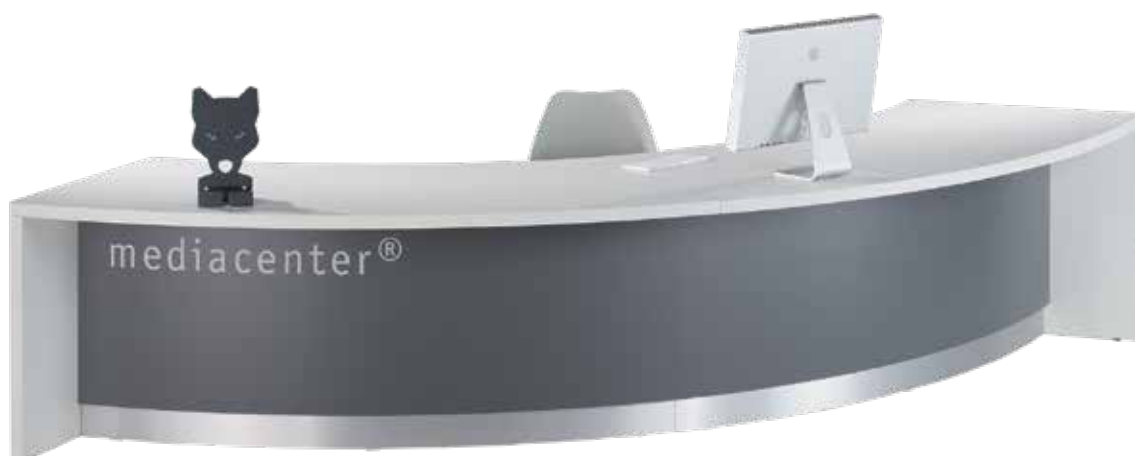

Recessed 45° curved counter

Components	Article no.	Price EUR	Quantity	EUR
45° recessed curved counter - starter (H740 mm)	BI2151429003	1.229,32	1	1.229,32
45° recessed curved counter - end (H740 mm)	BI2153429003	1.229,32	1	1.229,32
Wooden front panel for 45° curved counter (H740 mm)	BI3204543	2.104,06	2	4.208,12
Steel leg frame for recessed counter (H740 mm)	BI069546	396,21	1	396,21
Total price for configuration				7.062,97

Comments to configuration

- Computer, office chair, display and text are not included in price.
- All prices are based on colours and surfaces in price group A, see pages 4-7 for colours.
- We recommend the use of desk grommets, cable rails and drawer pedestals with the Inform counter, see page 113.

RECESSED COUNTER

RECTANGULAR COUNTERS

The design of Inform's recessed front panel allows for easy access on both sides of the counter and is especially suited for wheelchair use, as the front panel is placed 300 mm from the front. It is available in two heights; 740 and 1000 mm. This model can be combined with other recessed counters of the same height, step counters, height adjustable counters (only with H1000 mm standard counter), info counters, corner counters as well as display cabinets.

Recessed rectangular counter - starter

Remember to order front panel, see page 39 and leg frame/middle panel, see page 50. For counter with predrilled holes for cable conduct see pages 120-121.

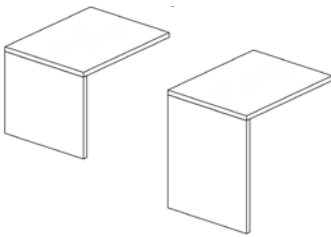

H	x	W	x	D
mm				
740	640	800		
740	840	800		
740	1040	800		
740	1240	800		
740	1440	800		
740	1640	800		
1000	640	800		
1000	840	800		
1000	1040	800		
1000	1240	800		
1000	1440	800		
1000	1640	800		

Item no. HPL	Price EUR
BI2101016003	677,37
BI2101018003	701,31
BI2101020003	749,32
BI2101022003	797,34
BI2101024003	857,05
BI2101026003	893,23
BI2101036003	724,19
BI2101038003	747,99
BI2101040003	796,01
BI2101042003	844,02
BI2101044003	903,87
BI2101046003	939,91

Recessed rectangular counter - middle

Remember to order front panel, see page 39 and leg frame/middle panel, see page 50. For counter with predrilled holes for cable conduct see pages 120-121.

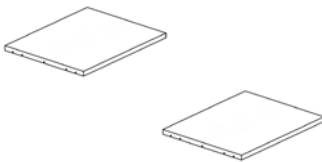

W	x	D
mm		
600	800	
800	800	
1000	800	
1200	800	
1400	800	
1600	800	

Item no. HPL	Price EUR
BI2102060003	353,38
BI2102080003	377,19
BI2102081003	425,47
BI2102082003	473,48
BI2102084003	533,33
BI2102086003	569,37

Recessed rectangular counter - end

Remember to order front panel, see page 39 and leg frame/middle panel, see page 50. For counter with predrilled holes for cable conduct see pages 120-121.

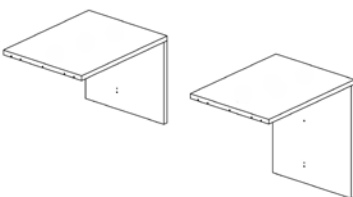

H	x	W	x	D
mm				
740	640	800		
740	840	800		
740	1040	800		
740	1240	800		
740	1440	800		
740	1640	800		
1000	640	800		
1000	840	800		
1000	1040	800		
1000	1240	800		
1000	1440	800		
1000	1640	800		

Item no. HPL	Price EUR
BI2103016003	677,37
BI2103018003	701,31
BI2103020003	749,32
BI2103022003	797,34
BI2103024003	857,05
BI2103026003	893,23
BI2103036003	724,19
BI2103038003	747,99
BI2103040003	796,01
BI2103042003	844,02
BI2103044003	903,87
BI2103046003	939,91

RECESSED COUNTER

FREESTANDING RECTANGULAR COUNTERS AND FRONT PANELS

The design of Inform's recessed front panel allows for easy access on both sides of the counter and is especially suited for wheelchair use, as the front panel is placed 300 mm from the front. Remember to order front panel.

Recessed rectangular counter - freestanding

Remember to order front panel. For counter with predrilled holes for cable conduct see pages 120-121.

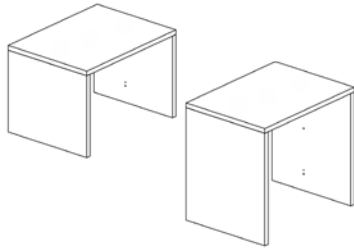

H x W x D mm	Item no. HPL	Price EUR
740 680 800	BI2104016003	1.001,49
740 880 800	BI2104018003	1.025,30
740 1080 800	BI2104020003	1.073,31
740 1280 800	BI2104022003	1.121,19
740 1480 800	BI2104024003	1.181,17
740 1680 800	BI2104026003	1.217,35
1000 680 800	BI2104036003	1.094,72
1000 880 800	BI2104038003	1.118,66
1000 1080 800	BI2104040003	1.166,68
1000 1280 800	BI2104042003	1.214,69
1000 1480 800	BI2104044003	1.274,54
1000 1680 800	BI2104046003	1.310,45

Wooden front panel for recessed rectangular counter

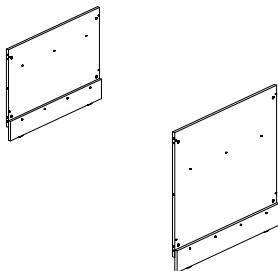

H x W mm	Item no. Melamine	Price EUR	Item no. Veneer	Price EUR
740 600	BI300146	205,22	BI300142	337,95
740 800	BI300346	235,81	BI300342	388,89
740 1000	BI300446	283,96	BI300442	467,76
740 1200	BI300546	314,94	BI300542	518,70
740 1400	BI300646	348,86	BI300642	574,29
740 1600	BI300746	401,66	BI300742	661,28
1000 600	BI300166	360,16	BI300162	593,18
1000 800	BI300366	367,21	BI300362	604,75
1000 1000	BI300466	471,75	BI300462	776,72
1000 1200	BI300566	486,91	BI300562	802,12
1000 1400	BI300666	491,70	BI300662	810,24
1000 1600	BI300766	496,62	BI300762	817,95

Acrylic front panel for recessed rectangular counter

Melaminecoated wooden frame.

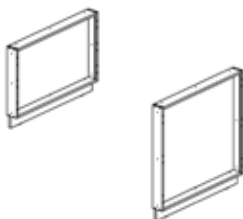

H x W mm	Item no. Acrylic & melamine	Price EUR
740 600	BI310146	770,07
740 800	BI310346	792,95
740 1000	BI310446	886,71
740 1200	BI310546	933,13
740 1400	BI310646	1.003,09
740 1600	BI310746	1.071,18
1000 600	BI310166	895,62
1000 800	BI310366	919,30
1000 1000	BI310466	1.012,53
1000 1200	BI310566	1.059,08
1000 1400	BI310666	1.129,04
1000 1600	BI310766	1.197,00

RECESSED COUNTER

45° CURVED COUNTERS

The design of Inform's recessed front panel allows for easy access on both sides of the counter and is especially suited for wheelchair use, as the front panel is placed 300 mm from the front. It is available in two heights; 740 and 1000 mm. This model can be combined with other recessed counters of the same height, step counters, height adjustable counters (only with H1000 mm standard counter), info counters, corner counters as well as display cabinets.

45° recessed curved counter - starter

Remember to order front panel, see page 41 and leg frame/middle panel, see page 50. For counter with predrilled holes for cable conduct see pages 120-121.

H	x	W	x	D
mm				
740		2030		800
1000		2030		800

Item no. HPL	Price EUR
BI2151429003	1.229,32
BI2151449003	1.276,14

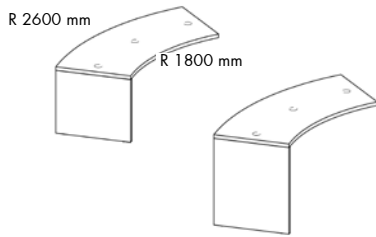

45° recessed curved counter - middle

Remember to order front panel, see page 41 and leg frame/middle panel, see page 50. For counter with predrilled holes for cable conduct see pages 120-121.

W	x	D
mm		
1800		800

Item no. HPL	Price EUR
BI2152489003	905,46

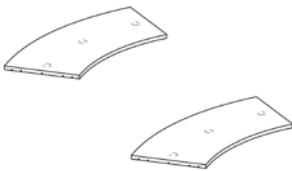

45° recessed curved counter - end

Remember to order front panel, see page 41 and leg frame/middle panel, see page 50. For counter with predrilled holes for cable conduct see pages 120-121.

H	x	W	x	D
mm				
740		2030		800
1000		2030		800

Item no. HPL	Price EUR
BI2153429003	1.229,32
BI2153449003	1.276,14

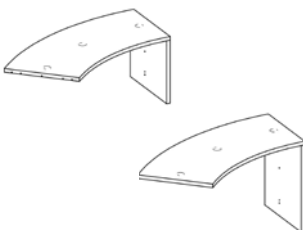

RECESSED COUNTER

FREESTANDING 45° CURVED COUNTERS AND FRONT PANELS

The design of Inform's recessed front panel allows for easy access on both sides of the counter and is especially suited for wheelchair use, as the front panel is placed 300 mm from the front. Remember to order front panel.

45° recessed curved counter - freestanding

Remember to order front panel. For counter with predrilled holes for cable conduct see pages 120-121.

H	x	W	x	D
mm				
740		2070		800
1000		2070		800

Item no. HPL	Price EUR
BI2154429003	1.553,31
BI2154449003	1.646,67

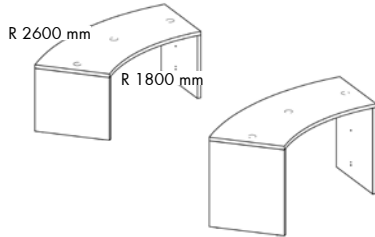

Wooden front panel for 45° recessed curved counter

H	x	W
mm		
740		1760
1000		1760

Item no. HPL	Price EUR
BI3204543	2.104,06
BI3204563	2.460,90

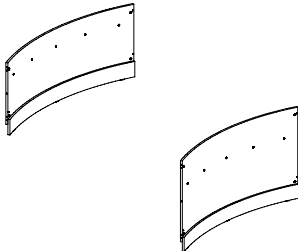

Acrylic front panel for 45° recessed curved counter

Melaminecoated wooden frame.

H	x	W
mm		
740		1760
1000		1760

Item no. Acrylic & melamine	Price EUR
BI3304546	1.509,68
BI3304566	1.611,69

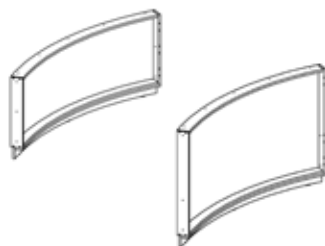

RECESSED COUNTER

90° CURVED COUNTERS

The design of Inform's recessed front panel allows for easy access on both sides of the counter and is especially suited for wheelchair use, as the front panel is placed 300 mm from the front. It is available in two heights; 740 and 1000 mm. This model can be combined with other recessed counters of the same height, step counters, height adjustable counters (only with H1000 mm standard counter), info counters, corner counters as well as display cabinets.

90° recessed curved counter - starter

Remember to order front panel, see page 43 and leg frame/middle panel, see page 50. For counter with predrilled holes for cable conduct see pages 120-121.

H	x	W	x	D
mm				
740	2220	800		
1000	2220	800		

Item no. HPL	Price EUR
BI2151929003	1.325,48
BI2151949003	1.372,16

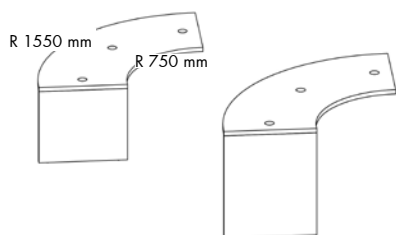

90° recessed curved counter - middle

Remember to order front panel, see page 43 and leg frame/middle panel, see page 50. For counter with predrilled holes for cable conduct see pages 120-121.

W	x	D
mm		
1800	800	

Item no. HPL	Price EUR
BI2152989003	1.001,62

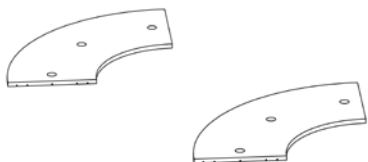

90° recessed curved counter - end

Remember to order front panel, see page 43 and leg frame/middle panel, see page 50. For counter with predrilled holes for cable conduct see pages 120-121.

H	x	W	x	D
mm				
740	2220	800		
1000	2220	800		

Item no. HPL	Price EUR
BI2153929003	1.325,48
BI2153949003	1.372,16

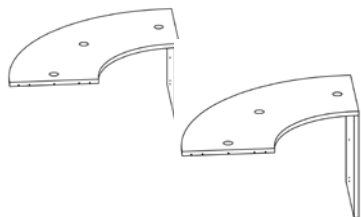

RECESSED COUNTER

FREESTANDING 90° CURVED COUNTERS AND FRONT PANELS

The design of Inform's recessed front panel allows for easy access on both sides of the counter and is especially suited for wheelchair use, as the front panel is placed 300 mm from the front. Remember to order front panel.

90° recessed curved counter - freestanding

Remember to order front panel. For counter with predrilled holes for cable conduct see pages 120-121.

H	x	W	x	D
mm				
740		2250		800
1000		2250		800

Item no.	Price
HPL	EUR
BI2154929003	1.649,60
BI2154949003	1.742,70

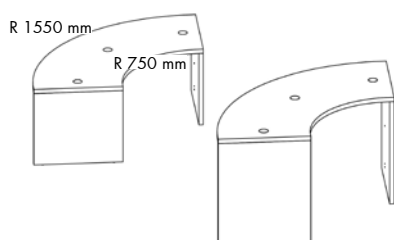

Wooden front panel for 90° recessed curved counter

H	x	W
mm		
740		1768
1000		1768

Item no.	Price
HPL	EUR
BI3209043	2.139,57
BI3209063	2.235,20

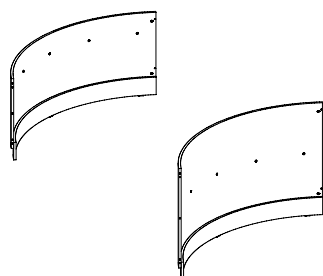

Acrylic front panel for 90° recessed curved counter

Melaminecoated wooden frame.

H	x	W
mm		
740		1768
1000		1768

Item no.	Price
Acrylic & melamine	EUR
BI3309046	1.947,79
BI3309066	2.074,00

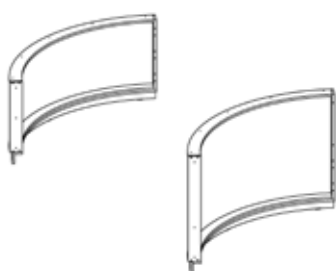

RECESSED COUNTER

RECTANGULAR COUNTERS - FOR CONNECTING TO STANDARD COUNTERS

The design of Inform's recessed front panel allows for easy access on both sides of the counter and is especially suited for wheelchair use, as the front panel is placed 300 mm from the front. It is available in two heights; 740 and 1000 mm. This model can be combined with standard counters of the same height by connecting with a middle panel (as the counter top is 40 mm wider than the recessed rectangular counter).

Recessed rectangular counter - starter - connected with middle panel

Remember to order front panel, see page 45 and middle panel, see page 50. For counter with predrilled holes for cable conduct see pages 120-121.

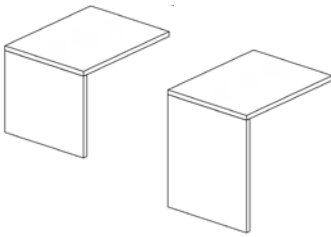

H	W	D
mm		
740	680	800
740	880	800
740	1080	800
740	1280	800
740	1480	800
740	1680	800
1000	680	800
1000	880	800
1000	1080	800
1000	1280	800
1000	1480	800
1000	1680	800

Item no. HPL	Price EUR
BI2121016003	677,37
BI2121018003	701,31
BI2121020003	749,32
BI2121022003	797,34
BI2121024003	857,05
BI2121026003	893,23
BI2121036003	724,19
BI2121038003	747,99
BI2121040003	796,01
BI2121042003	844,02
BI2121044003	903,87
BI2121046003	939,91

Recessed rectangular counter - middle - connected with middle panel

Remember to order front panel, see page 45 and middle panel, see page 50. For counter with predrilled holes for cable conduct see pages 120-121.

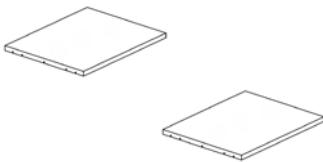

W	D
mm	
640	800
840	800
1040	800
1240	800
1440	800
1640	800

Item no. HPL	Price EUR
BI2122060003	353,38
BI2122080003	377,19
BI2122081003	425,47
BI2122082003	473,48
BI2122084003	533,33
BI2122086003	569,37

Recessed rectangular counter - end - connected with middle panel

Remember to order front panel, see page 45 and middle panel, see page 50. For counter with predrilled holes for cable conduct see pages 120-121.

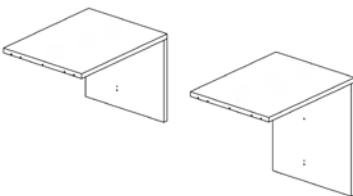

H	W	D
mm		
740	680	800
740	880	800
740	1080	800
740	1280	800
740	1480	800
740	1680	800
1000	680	800
1000	880	800
1000	1080	800
1000	1280	800
1000	1480	800
1000	1680	800

Item no. HPL	Price EUR
BI2123016003	677,37
BI2123018003	701,31
BI2123020003	749,32
BI2123022003	797,34
BI2123024003	857,05
BI2123026003	893,23
BI2123036003	724,19
BI2123038003	747,99
BI2123040003	796,01
BI2123042003	844,02
BI2123044003	903,87
BI2123046003	939,91

RECESSED COUNTER

RECTANGULAR FRONT PANELS

Remember to order front panel.

Wooden front panel for recessed rectangular counter

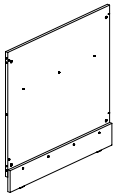
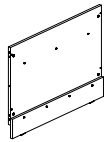

H x W mm	Item no. Melamine	Price EUR	Item no. Veneer	Price EUR
740 600	BI300146	205,22	BI300142	337,95
740 800	BI300346	235,81	BI300342	388,89
740 1000	BI300446	283,96	BI300442	467,76
740 1200	BI300546	314,94	BI300542	518,70
740 1400	BI300646	348,86	BI300642	574,29
740 1600	BI300746	401,66	BI300742	661,28
1000 600	BI300166	360,16	BI300162	593,18
1000 800	BI300366	367,21	BI300362	604,75
1000 1000	BI300466	471,75	BI300462	776,72
1000 1200	BI300566	486,91	BI300562	802,12
1000 1400	BI300666	491,70	BI300662	810,24
1000 1600	BI300766	496,62	BI300762	817,95

Acrylic front panel for recessed rectangular counter

Melaminecoated wooden frame.

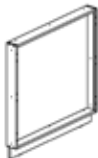
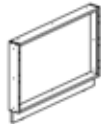

H x W mm	Item no. Acrylic & melamine	Price EUR
740 600	BI310146	770,07
740 800	BI310346	792,95
740 1000	BI310446	886,71
740 1200	BI310546	933,13
740 1400	BI310646	1.003,09
740 1600	BI310746	1.071,18
1000 600	BI310166	895,62
1000 800	BI310366	919,30
1000 1000	BI310466	1.012,53
1000 1200	BI310566	1.059,08
1000 1400	BI310666	1.129,04
1000 1600	BI310766	1.197,00

RECESSED COUNTER

45° CURVED COUNTERS - FOR CONNECTING TO STANDARD COUNTERS

The design of Inform's recessed front panel allows for easy access on both sides of the counter and is especially suited for wheelchair use, as the front panel is placed 300 mm from the front. It is available in two heights; 740 and 1000 mm. This model can be combined with standard counters of the same height by connecting with a middle panel (as the counter top is 40 mm wider than the recessed 45° curved counter).

45° recessed curved counter - starter - connected with middle panel

Remember to order front panel, see page 47 and middle panel, see page 50. For counter with predrilled holes for cable conduct see pages 120-121.

H	x	W	x	D
mm				
740		2030		800
1000		2030		800

Item no. HPL	Price EUR
BI2161429003	1.229,32
BI2161449003	1.276,14

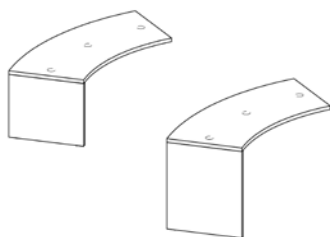

45° recessed curved counter - end - connected with middle panel

Remember to order front panel, see page 47 and middle panel, see page 50. For counter with predrilled holes for cable conduct see pages 120-121.

H	x	W	x	D
mm				
740		2030		800
1000		2030		800

Item no. HPL	Price EUR
BI2163429003	1.229,32
BI2163449003	1.276,14

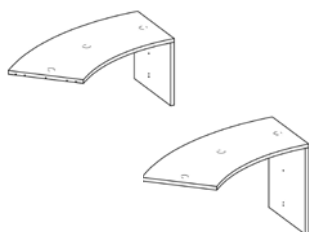

RECESSED COUNTER

45° CURVED FRONT PANELS

Remember to order front panel.

Wooden front panel for 45° recessed curved counter

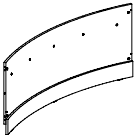
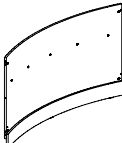
	H x W mm	Item no. HPL	Price EUR
	740 1760	BI3204543	2.104,06
	1000 1760	BI3204563	2.460,90

Acrylic front panel for 45° recessed curved counter

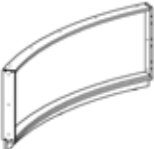
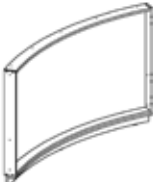
Melaminecoated wooden frame.	H x W mm	Item no. Acrylic & melamine	Price EUR
	740 1760	BI3304546	1.509,68
	1000 1760	BI3304566	1.611,69

RECESSED COUNTER

90° CURVED COUNTERS - FOR CONNECTING TO STANDARD COUNTERS

The design of Inform's recessed front panel allows for easy access on both sides of the counter and is especially suited for wheelchair use, as the front panel is placed 300 mm from the front. It is available in two heights; 740 and 1000 mm. This model can be combined with standard counters of the same height by connecting with a middle panel (as the counter top is 40 mm wider than the recessed 90° curved counter).

90° recessed curved counter - starter - connected with middle panel

Remember to order front panel, see page 49 and middle panel, see page 50. For counter with predrilled holes for cable conduct see pages 120-121.

H	x	W	x	D
mm				
740		2220		800
1000		2220		800

Item no. HPL	Price EUR
BI2161929003	1.325,48
BI2161949003	1.372,16

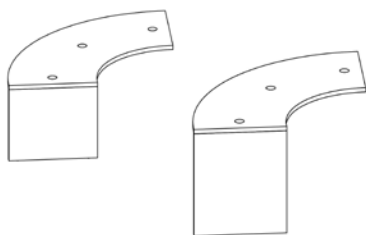

90° recessed curved counter - end - connected with middle panel

Remember to order front panel, see page 49 and middle panel, see page 50. For counter with predrilled holes for cable conduct see pages 120-121.

H	x	W	x	D
mm				
740		2220		800
1000		2220		800

Item no. HPL	Price EUR
BI2163929003	1.325,48
BI2163949003	1.372,16

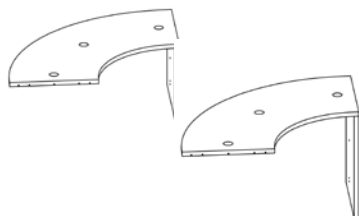

RECESSED COUNTER

90° CURVED FRONT PANELS

Remember to order front panel.

Wooden front panel for 90° recessed curved counter

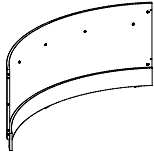
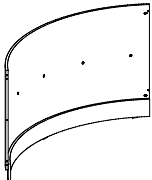
	H x W mm	Item no. HPL	Price EUR
	740 1768	BI3209043	2.139,57
	1000 1768	BI3209063	2.235,20

Acrylic front panel for 90° recessed curved counter

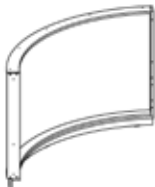
Melaminecoated wooden frame.	H x W mm	Item no. Acrylic & melamine	Price EUR
	740 1768	BI3309046	1.947,79
	1000 1768	BI3309066	2.074,00

RECESSED COUNTERS

CONNECTIONS

If you wish to combine a recessed rectangular/curved counter with a recessed rectangular/curved counter of the same height, you must use a steel leg frame.

If you wish to combine a recessed rectangular/curved counter with standard rectangular/curved or step counter, you must use a middle panel.

Steel leg frame for recessed counters

Must be used when assembling 2 recessed modules of the same height.

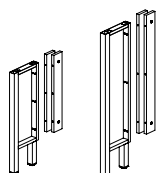

Finish	H mm	Item no. Melamine/veneer	Price EUR
Melamine	740	BI069546	396,21
	1000	BI069566	443,95
Veneer	740	BI069542	652,50
	1000	BI069562	731,23

Middle panel for recessed and standard counters

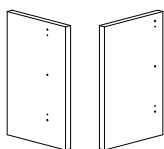

Side of panel	H mm	Item no. HPL	Price EUR
Left : Recessed counter Right: Standard counter	740	BI3704103	170,37

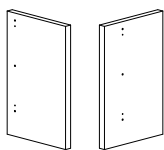

Left: Standard counter Right: Recessed counter	740	BI3704113	170,37
---	-----	-----------	--------

Middle panel for recessed and step counter

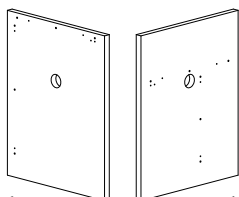

Side of panel	H mm	Item no. HPL	Price EUR
Left: Step counter Right: Recessed counter	1000	BI3706143	348,46

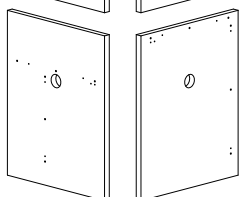

Left: Recessed counter Right: Step counter	1000	BI3706153	348,46
---	------	-----------	--------

Middle panel for height adjustable and recessed counter

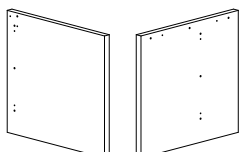

Side of panel	H mm	Item no. HPL	Price EUR
Left: Height adjustable counter Right: Recessed counter	740	BI3704163	170,37

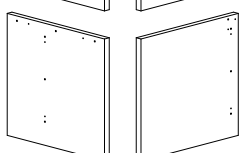

Left: Recessed counter Right: Height adjustable counter	740	BI3704173	170,37
--	-----	-----------	--------

RECESSED COUNTERS

CONFIGURATIONS

If you wish to combine a recessed counter with standard rectangular/curved, height adjustable or step counter, you must use one of the panels on page 50. Remember always to construct your counter from left to right when sitting behind the counter.

Rectangular counters with 2 standard fronts and 1 recessed front

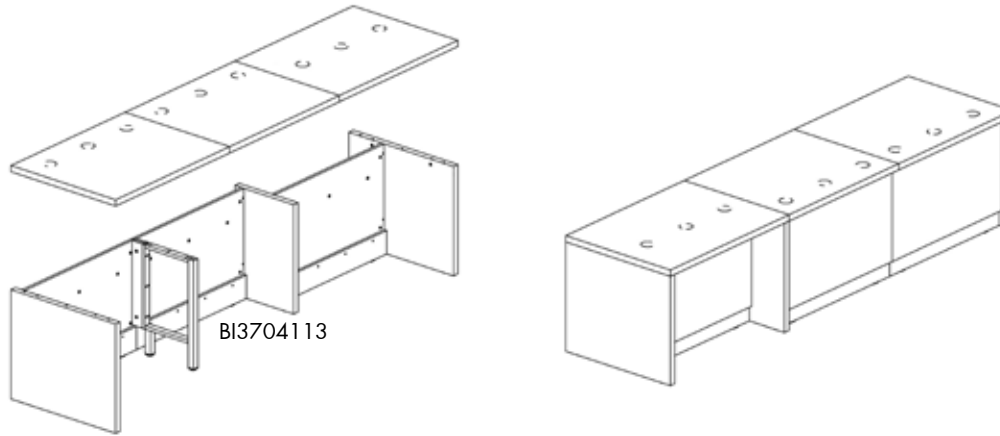

Recessed and step counters

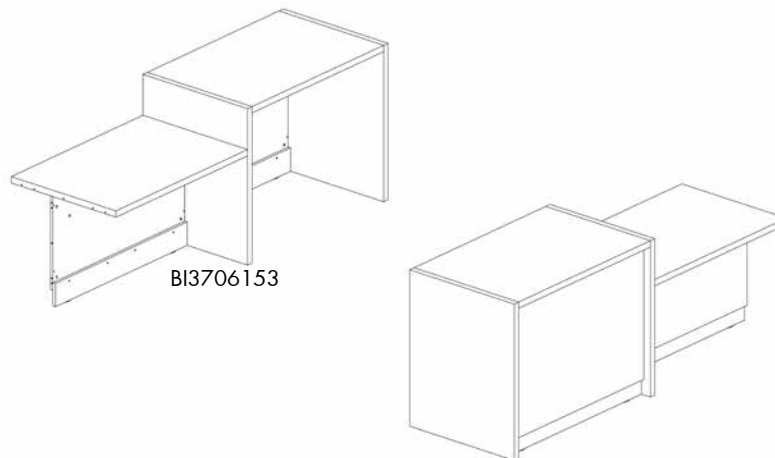

Recessed rectangular and height adjustable counter

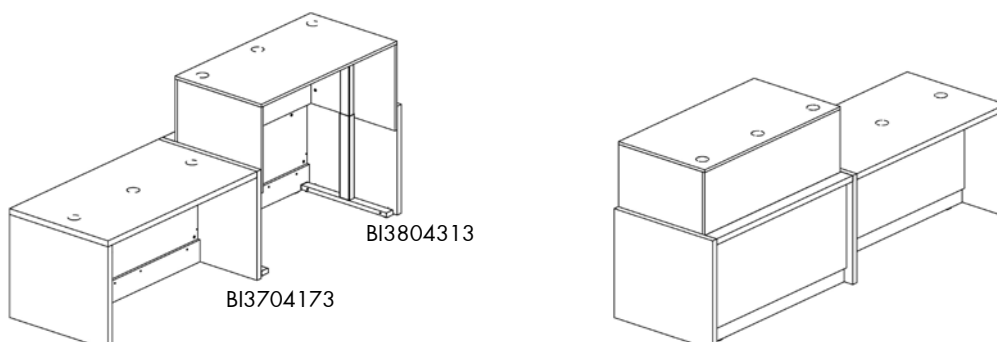

STEP COUNTER

CONFIGURATION NO. 5

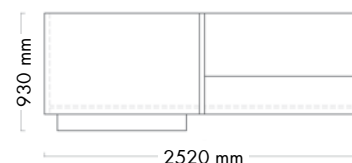

Rectangular & step counters (with counter shelf and bag shelf)

Components	Article no.	Price EUR	Quantity	EUR
Rectangular counter - starter (W1240 x H740 mm)	BI2001022003	797,34	1	797,34
Wooden front panel for rectangular counter (W1200 x H740 mm)	BI300546	314,94	1	314,94
Counter shelf and front for rectangular counter - starter (W1240 mm)	BI4101056	510,99	1	510,99
Middle panel for step and standard counter (H1000 mm)	BI3706133	348,46	1	348,46
Rectangular counter - end (W1240 x H1000 mm)	BI2003042003	844,02	1	844,02
Wooden front panel for rectangular counter (W1200 x H1000 mm)	BI300566	486,91	1	486,91
Wooden bag shelf for rectangular counter (W1200 mm)	BI81053	204,16	1	204,16
Total price for configuration				3.506,82

Comments to configuration

- Monitor, office chair and text are not included in price.
- All prices are based on colours and surfaces in price group A, see pages 4-7 for colours.
- We recommend the use of desk grommets, cable rails and drawer pedestals with the Inform counter, see page 113.
- The bag shelf is in fact 1000 mm long, adapted to a 1200 mm front panel.

STEP COUNTER

CONFIGURATION NO. 6

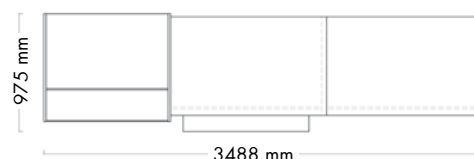

Rectangular & step counters with presentation cabinet (with bag shelf)

Components	Article no.	Price EUR	Quantity	EUR
Rectangular counter - starter (W1240 x H740 mm)	BI2001022003	797,34	1	797,34
Wooden front panel for rectangular counter (W1200 x H740 mm)	BI300546	314,94	1	314,94
Middle panel for step and standard counter (H1000 mm)	BI3706133	348,46	1	348,46
Rectangular counter - middle (W1200 x H1000 mm)	BI2002082003	497,42	1	497,42
Wooden front panel for rectangular counter (W1200 x H1000 mm)	BI300566	486,91	1	486,91
Display cabinet with 2 shelves & shelving options (W1008 x H1130 mm)	BI525127006	1.702,13	1	1.702,13
Steel intermediate shelf with backedge (W1000 x D300 mm)	B401803131	66,37	4	265,48
Wooden bag shelf for rectangular counter (W1200 mm)	BI81053	204,16	1	204,16
Total price for configuration				4.616,84

Comments to configuration

- Monitor, office chair and text are not included in price.
- All prices are based on colours and surfaces in price group A, see pages 4-7 for colours.
- We recommend the use of desk grommets, cable rails and drawer pedestals with the Inform counter, see page 113.
- The bag shelf is in fact 1000 mm long, adapted to a 1200 mm front panel.
- Shelves are not included in presentation cabinet. For full overview of shelving options for presentation cabinet, see page 101.

STEP COUNTER

COUNTER TOPS

Vary the height of the Inform counter by adding a simple module - a step counter top. The counter top can be used for the two heights; 740 and 1000 mm. To combine with standard and recessed counters, see page 57.

Step counter top

Remember to order middle panels. For counter with predrilled holes for cable conduct see pages 120-121.



H x W x D mm	Item no. HPL	Price EUR
740 600 800	BI2002060003	377,19
740 800 800	BI2002080003	422,67
740 1000 800	BI2002081003	449,41
740 1200 800	BI2002082003	497,42
740 1400 800	BI2002084003	557,94
740 1600 800	BI2002086003	593,18

Steel leg frame

Must be used when assembling 2 modules of the same height.



H mm	Item no. Melamine	Price EUR	Item no. Veneer	Price EUR
1000	BI069166	423,47	BI069162	697,45

STEP COUNTER

FRONT PANELS

Vary the height of the Inform counter by adding a simple module - a step counter top. The counter top can be used for the two heights; 740 and 1000 mm. To combine with standard and recessed counters, see page 57.

Wooden front panel for step counter

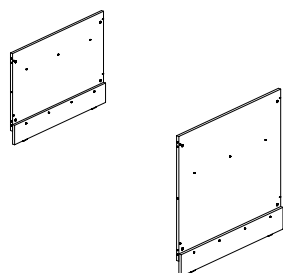

H x W mm	Item no. Melamine	Price EUR	Item no. Veneer	Price EUR
740 600	BI300146	205,22	BI300142	337,95
740 800	BI300346	235,81	BI300342	388,89
740 1000	BI300446	283,96	BI300442	467,76
740 1200	BI300546	314,94	BI300542	518,70
740 1400	BI300646	348,86	BI300642	574,29
740 1600	BI300746	401,66	BI300742	661,28
1000 600	BI300166	360,16	BI300162	593,18
1000 800	BI300366	367,21	BI300362	604,75
1000 1000	BI300466	471,75	BI300462	776,72
1000 1200	BI300566	486,91	BI300562	802,12
1000 1400	BI300666	491,70	BI300662	810,24
1000 1600	BI300766	496,62	BI300762	817,95

Acrylic front panel for step counter

Melaminecoated wooden frame.

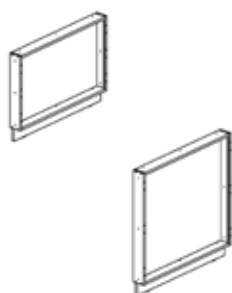

H x W mm	Item no. Acrylic & melamine	Price EUR
74 600	BI310146	770,07
740 800	BI310346	792,95
740 1000	BI310446	886,71
740 1200	BI310546	933,13
740 1400	BI310646	1.003,09
740 1600	BI310746	1.071,18
1000 600	BI310166	895,62
1000 800	BI310366	919,30
1000 1000	BI310466	1.012,53
1000 1200	BI310566	1.059,08
1000 1400	BI310666	1.129,04
1000 1600	BI310766	1.197,00

STEP COUNTER

MIDDLE PANELS

It is necessary to order side and middle panels for the step counter, depending on the construction of your complete counter. See overview of panels below. Remember always to construct your counter from left to right when sitting behind the counter!

Middle panel for step and standard counter

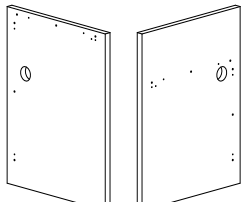
	Side of panel	H mm	Item no. HPL	Price EUR
	Left: Step counter Right: Standard counter (H740 mm)	1000	BI3706123	348,46
	Left: Standard counter (H740 mm) Right: Step counter	1000	BI3706133	348,46

Middle panel for step and recessed counter

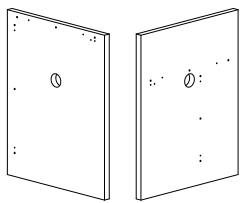
	Side of panel	H mm	Item no. HPL	Price EUR
	Left: Step counter Right: Recessed counter	1000	BI3706143	348,46
	Left: Recessed counter Right: Step counter	1000	BI3706153	348,46

STEP COUNTER

CONFIGURATIONS

The counter can be installed using either the middle panel or leg frame, depending on whether the counter is placed next to another standard counter or display cabinet. See overview of middle panels on page 56. Remember always to construct your counter from left to right when sitting behind the counter!

Standard and step counter

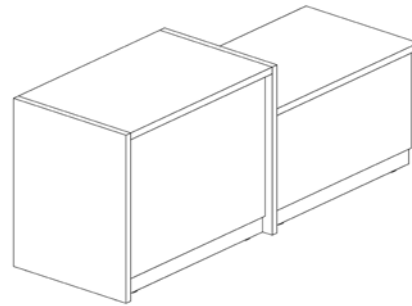
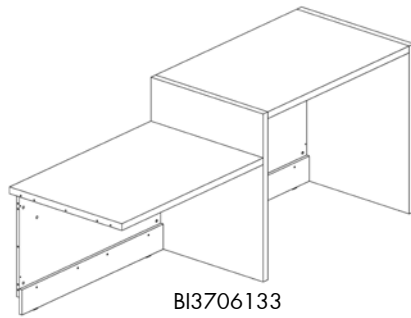

Step, recessed and height adjustable counter

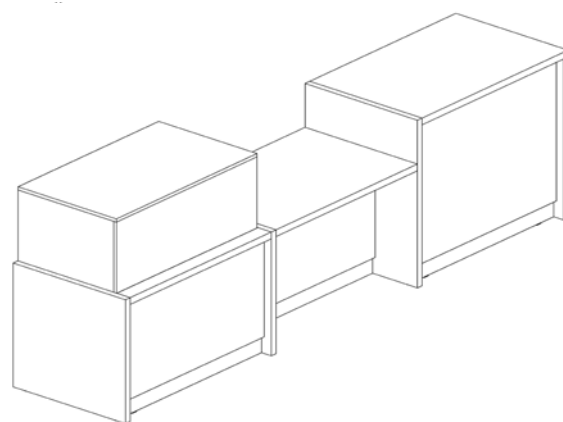
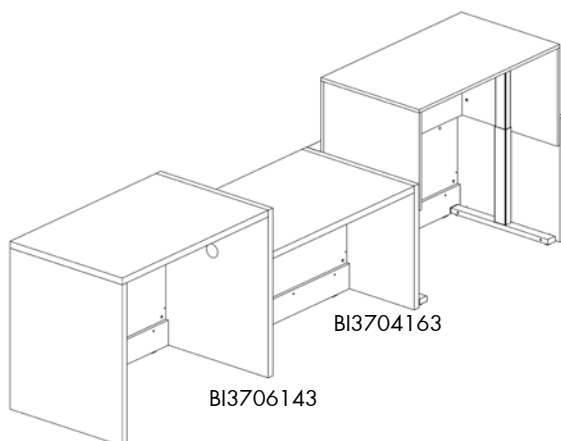

CORNER COUNTER

CONFIGURATION NO. 11

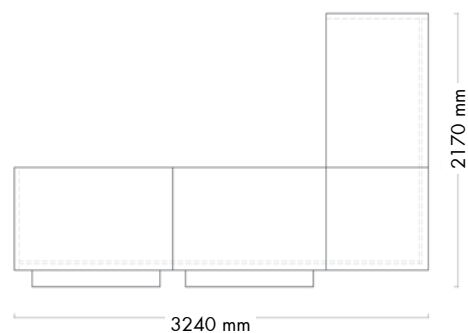

Rectangular & square corner counters (with bag shelves)

Components	Article no.	Price EUR	Quantity	EUR
Rectangular counter - starter (W1240 x H740 mm)	BI2001022003	797,34	1	797,34
Rectangular counter - middle (W1200 x H740 mm)	BI2002082003	497,42	1	497,42
Rectangular counter - end (W1240 x H740 mm)	BI2003022003	797,34	1	797,34
Square corner counter top (H740 mm)	BI26530003	455,79	1	455,79
Wooden front panel for rectangular counter (W1200 x H740 mm)	BI300546	314,94	3	944,82
Wooden front panel for square corner counter (H740 mm)	BI340346	648,77	1	648,77
Wooden bag shelf for rectangular counter (W1200 mm)	BI81053	204,16	2	408,32
Steel leg frame (H740 mm)	BI069146	379,72	3	1.139,16
Monitor arm	B401184	845,08	1	845,08
Total price for configuration				6.534,04

Comments to configuration

- Monitor, key board, office chairs and text are not included in price.
- All prices are based on colours and surfaces in price group A, see pages 4-7 for colours.
- We recommend the use of desk grommets, cable rails and drawer pedestals with the Inform counter, see page 113.
- The bag shelf is in fact 1000 mm long, adapted to a 1200 mm front panel.
- It is necessary to drill an Ø80 mm hole for the monitor arm on site or modify the article number for counter for predrilled hole, see pages 120-121.

CORNER COUNTER

CONFIGURATION NO. 12

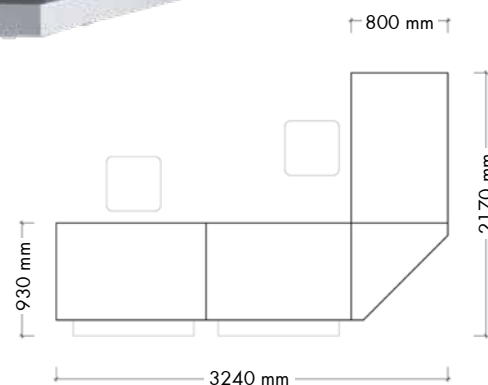

Rectangular & triangular corner counters (with bag shelves)

Components	Article no.	Price EUR	Quantity	EUR
Rectangular counter - starter (W1240 x H740 mm)	BI2001022003	797,34	1	797,34
Rectangular counter - middle (W1200 x H740 mm)	BI2002082003	497,42	1	497,42
Rectangular counter - end (W1240 x H740 mm)	BI2003022003	797,34	1	797,34
Wooden front panel for rectangular counter (W1200 x H740 mm)	BI300546	314,94	3	944,82
Triangular corner counter top (H740 mm)	BI26833003	505,93	1	505,93
Wooden front panel for triangular corner counter (H740 mm)	BI345346	473,75	1	473,75
Wooden bag shelf for rectangular counter (W1200 mm)	BI81053	204,16	2	408,32
Steel leg frame (H740 mm)	BI069146	379,72	3	1.139,16
Total price for configuration				5.564,08

Comments to configuration

- Monitor, office chair and text are not included in price.
- All prices are based on colours and surfaces in price group A, see pages 4-7 for colours.
- We recommend the use of desk grommets, cable rails and drawer pedestals with the Inform counter, see page 113.
- The bag shelf is in fact 1000 mm long, adapted to a 1200 mm front panel.

CORNER COUNTER

SQUARE CORNER COUNTER TOPS, FRONT PANELS AND LEG FRAME

The corner counter is ideal for combining with the rectangular counter and the info table. The corner counter creates a sharp angle with no optical interruptions, maintaining the design of a continuous frame.

Square corner counter top

Remember to order leg frame and front panel. For counter with predrilled holes for cable conduct see pages 120-121.

W	x	D
mm		
800		800

Item no. HPL	Price EUR
BI26530003	455,79



Wooden front panel for square corner counter

Remember to order leg frame.

H	x	W	x	D
mm				
740		800		800
1000		800		800

Item no. Melamine	Price EUR	Item no. Veneer	Price EUR
BI340346	648,77	BI340342	1.068,66
BI340366	743,60	BI340362	1.224,66

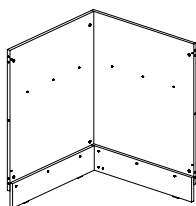
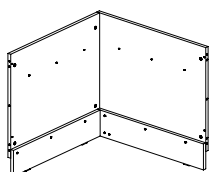

Steel leg frame

Must be used when assembling 2 modules of the same height.

H
mm
740
1000

Item no. Melamine	Price EUR	Item no. Veneer	Price EUR
BI069146	379,72	BI069142	625,37
BI069166	423,47	BI069162	697,45

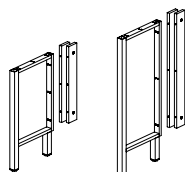

CORNER COUNTER

TRIANGULAR CORNER COUNTER TOPS, FRONT PANELS AND LEG FRAME

The triangular corner counter can be used for combining many of the other Inform counters. Create an open, informal look with the triangular corner counter and make a contrast to the linear lines usually found in a library.

Triangular corner counter top

Remember to order leg frame and front panel. For counter with predrilled holes for cable conduct see pages 120-121.

W x D mm	Item no. HPL	Price EUR
800 800	BI26833003	505,93

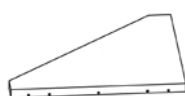

Wooden front panel for triangular corner counter

Remember to order leg frame.

H x W x D mm	Item no. Melamine	Price EUR	Item no. Veneer	Price EUR
740 800 800	BI345346	473,75	BI345342	780,05
1000 800 800	BI345366	511,25	BI345362	842,02

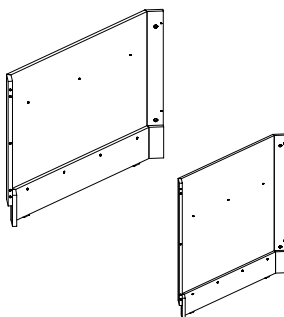

Steel leg frame

Must be used when assembling 2 modules of the same height.

H mm	Item no. Melamine	Price EUR	Item no. Veneer	Price EUR
740	BI069146	379,72	BI069142	625,37
1000	BI069166	423,47	BI069162	697,45

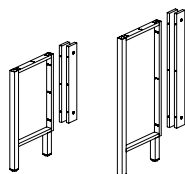

INFO TABLE

CONFIGURATION NO. 13



45° & 90° curved counters & info table with foot

Components	Article no.	Price EUR	Quantity	EUR
45° curved counter - starter (H740 mm)	BI2051428003	1.229,32	1	1.229,32
45° curved counter - middle (H740 mm)	BI2052488003	905,46	1	905,46
Wooden front panel for 45° curved counter (H740 mm)	BI3204543	2.104,06	2	4.208,12
90° curved counter - middle (H740 mm)	BI2052988003	1.001,62	1	1.001,62
Wooden front panel for 90° curved counter (H740 mm)	BI3209043	2.139,57	1	2.139,57
Info table - end (W800 x H740 mm)	BI27030343	624,44	1	624,44
Wooden side panel for info table (H740 mm)	BI38546	394,08	1	394,08
Steel leg frame (H740 mm)	BI069146	379,72	3	1.139,16
Monitor arm	B401184	845,08	1	845,08
Total price for configuration				12.486,85

Comments to configuration

- Monitor, key board, office chair, chairs and text are not included in price.
- All prices are based on colours and surfaces in price group A, see pages 4-7 for colours.
- We recommend the use of desk grommets, cable rails and drawer pedestals with the Inform counter, see page 113.
- It is necessary to drill an Ø80 mm hole for the monitor arm on site or modify the article number for counter for predrilled hole, see pages 120-121.

INFO TABLE

CONFIGURATION NO. 14

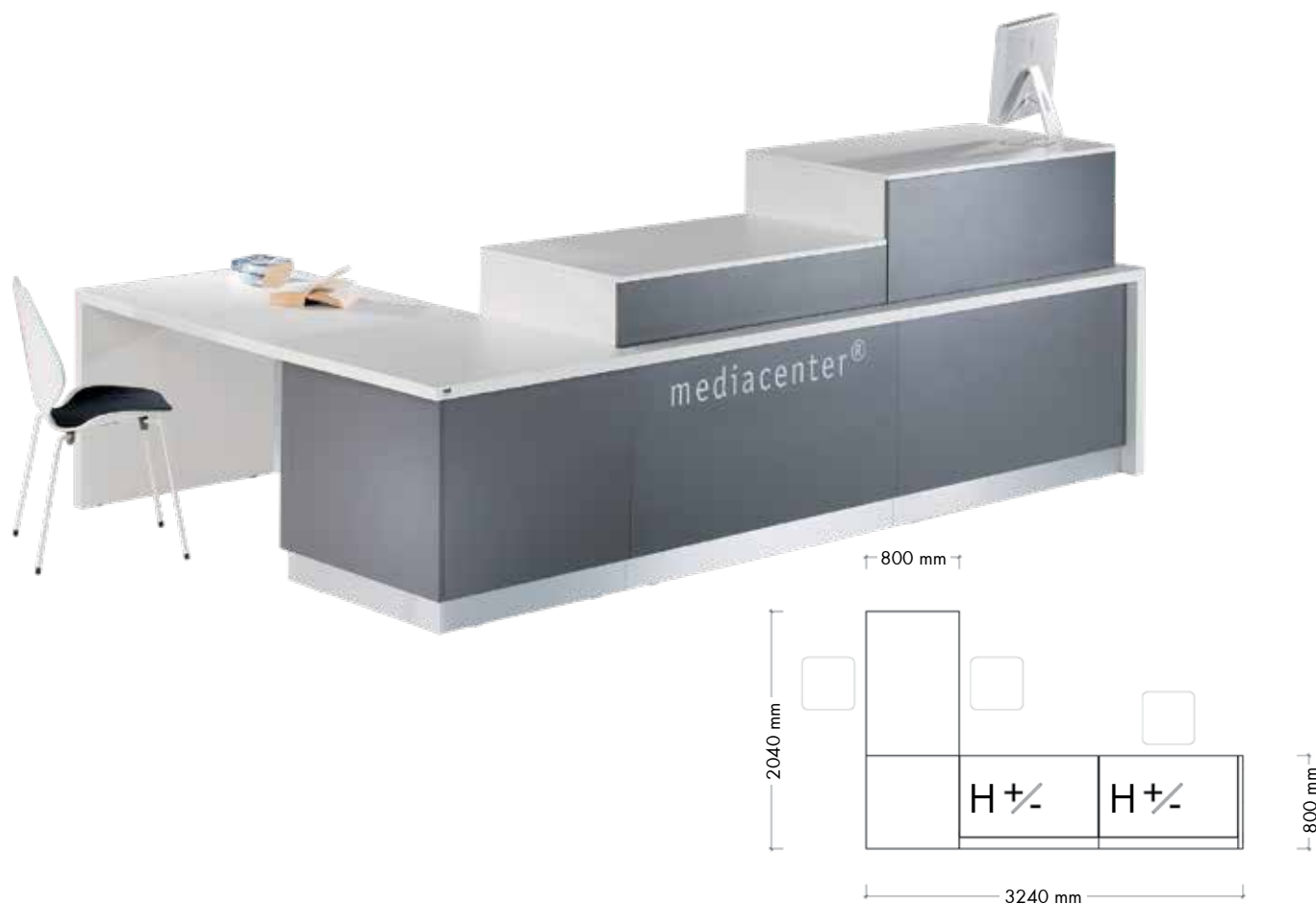

Height adjustable counter, corner counter & info table with panel

Components	Article no.	Price EUR	Quantity	EUR
Left side panel for height adjustable counter (H740 mm)	BI3804303	311,89	1	311,89
Height adjustable counter - starter, middle and end (W1200 mm)	BI24015006	3.889,98	2	7.779,96
Wooden front panel for height adjustable counter (W1200 x H740 mm)	BI350546	544,64	2	1.089,28
Square corner counter top for height adjustable counter on left side	BI26520003	468,43	1	468,43
Middle panel for height adjustable and standard counter (H740 mm)	BI3704193	348,46	1	348,46
Wooden front panel for square corner counter (H740 mm)	BI340346	648,77	1	648,77
Wooden side panel for info table (H740 mm)	BI38546	394,08	1	394,08
Steel leg frame for info table (H740 mm)	BI069146	379,72	1	379,72
Info table - end (H740 x W1240 mm)	BI28030543	875,27	1	875,27
Total price for configuration				12.295,86

Comments to configuration

- Monitor, chair and text are not included in price.
- All prices are based on colours and surfaces in price group A, see pages 4-7 for colours.
- We recommend the use of desk grommets, cable rails and drawer pedestals with the Inform counter, see page 113.

INFO TABLE

COUNTER TOPS WITH FOOT, SIDE PANEL AND LEG FRAME

As an adviser, you need to portray openness and show communicative skills. This also applies for the furniture. Our info table enlarges your work area with a short table element. It provides you with an open and informal space for small discussions.

Info table - starter

Foot included. Remember to order leg frame and wooden side panel.

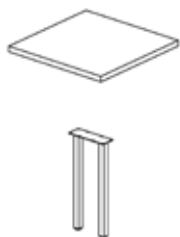

H x W x D mm	Item no. HPL	Price EUR
740 800 800	BI27010343	624,44
1000 800 800	BI27010363	648,38

Info table - end

Foot included. Remember to order leg frame and wooden side panel.

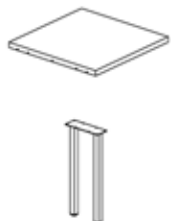

H x W x D mm	Item no. HPL	Price EUR
740 800 800	BI27030343	624,44
1000 800 800	BI27030363	648,38

Steel leg frame

Must be used when assembling 2 modules of the same height.

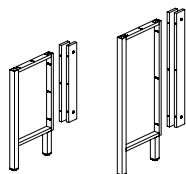

H mm	Item no. Melamine	Price EUR	Item no. Veneer	Price EUR
740	BI069146	379,72	BI069142	625,37
1000	BI069166	423,47	BI069162	697,45

Wooden side panel for info table

Used to create a finish on adjacent counter. Wooden side panel to be placed at the end of adjacent counter, with leg frame inside.

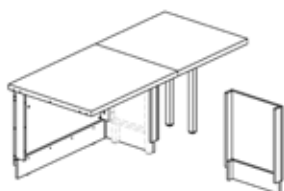

H x W x D mm	Item no. Melamine	Price EUR	Item no. Veneer	Price EUR
740 800 510	BI38546	394,08	BI38542	648,91
1000 800 510	BI38566	418,29	BI38562	688,94

INFO TABLE

COUNTER TOPS WITH PANEL, FRONT PANELS AND LEG FRAME

As an adviser, you need to portray openness and show communicative skills. This also applies for the furniture. Our info table enlarges your work area with a short table element. It provides you with an open and informal space for small discussions.

Info table - starter

Remember to order leg frame and wooden side panel for inside of adjacent counter.

H	x	W	x	D
mm				
740		840		800
740		1040		800
740		1240		800

Item no. HPL	Price EUR
BI28010343	760,23
BI28010443	846,68
BI28010543	875,27

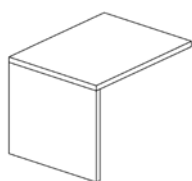

Info table - end

Remember to order leg frame and wooden side panel for inside of adjacent counter.

H	x	W	x	D
mm				
740		840		800
740		1040		800
740		1240		800

Item no. HPL	Price EUR
BI28030343	760,23
BI28030443	846,68
BI28030543	875,27

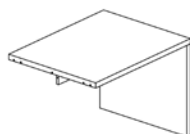

Steel leg frame for info table

Must be used when assembling 2 modules of the same height.

H mm	Item no. Melamine	Price EUR	Item no. Veneer	Price EUR
740	BI069146	379,72	BI069142	625,37

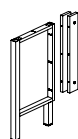

Wooden side panel for info table

Used to create a finish on adjacent counter. Wooden side panel to be placed at the end of adjacent counter with leg frame inside.

H	x	W	x	D	Item no. Melamine	Price EUR	Item no. Veneer	Price EUR
mm								
740		80		360	BI38546	394,08	BI38542	648,91

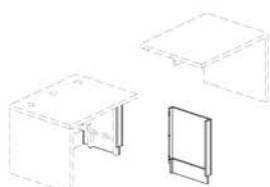

HEIGHT ADJUSTABLE COUNTER

CONFIGURATION NO. 7

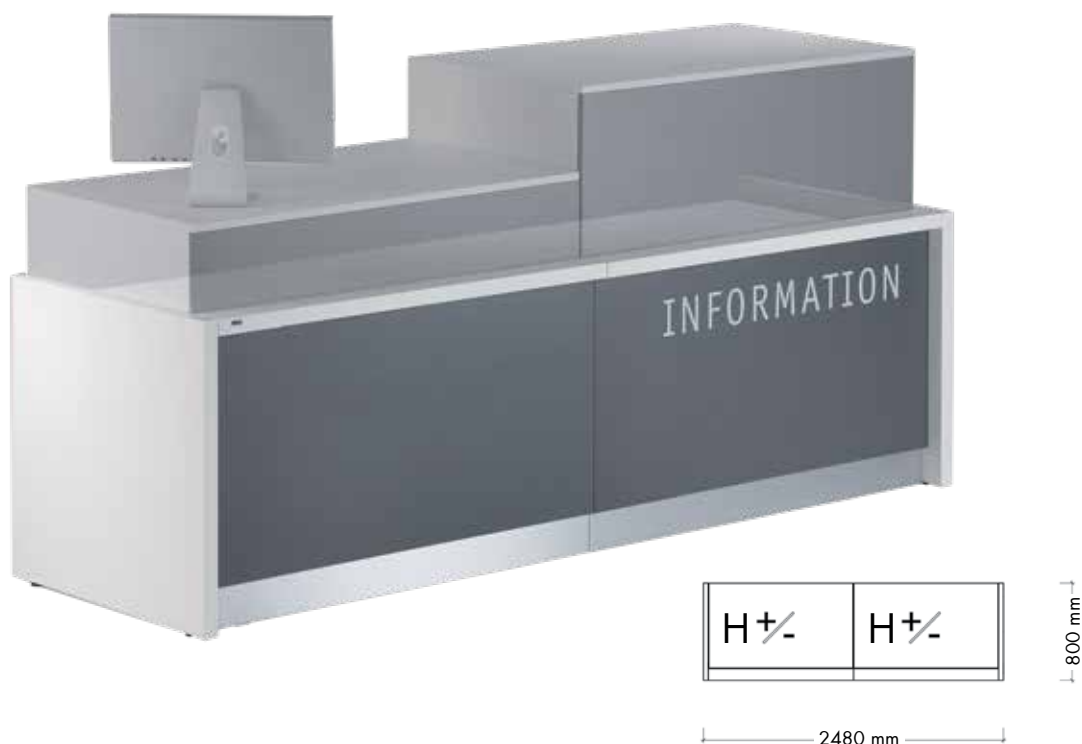

Rectangular height adjustable counters

Components	Article no.	Price EUR	Quantity	EUR
Left side panel for height adjustable counter (H740 mm)	BI3804303	311,89	1	311,89
Height adjustable counter - starter, middle and end (W1200 mm)	BI24015006	3.889,98	2	7.779,96
Wooden front panel for height adjustable counter (W1200 x H740 mm)	BI350546	544,64	2	1.089,28
Right side panel for height adjustable counter (H740 mm)	BI3804313	311,89	1	311,89
Total price for configuration				9.493,02

Comments to configuration

- Monitor and text are not included in price.
- All prices are based on colours and surfaces in price group A, see pages 4-7 for colours.
- We recommend the use of desk grommets, cable rails and drawer pedestals with the Inform counter, see page 113.

HEIGHT ADJUSTABLE COUNTER

CONFIGURATION NO. 8



Note: the front is flat

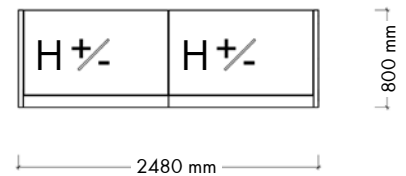

Rectangular height adjustable counters (with acrylic front)

Components	Article no.	Price EUR	Quantity	EUR
Left side panel for height adjustable counter (H740 mm)	BI3804303	311,89	1	311,89
Height adjustable counter - starter, middle and end (W1200 mm)	BI24015006	3.889,98	2	7.779,96
Acrylic front panel for height adjustable counter (W1200 x H740 mm)	BI360543	886,58	2	1.773,16
Right side panel for height adjustable counter (H740 mm)	BI3804313	311,89	1	311,89
Total price for configuration				10.176,90

Comments to configuration

- Text is not included in price.
- All prices are based on colours and surfaces in price group A, see pages 4-7 for colours.
- We recommend the use of desk grommets, cable rails and drawer pedestals with the Inform counter, see page 113.

HEIGHT ADJUSTABLE COUNTER

CONFIGURATION NO. 9

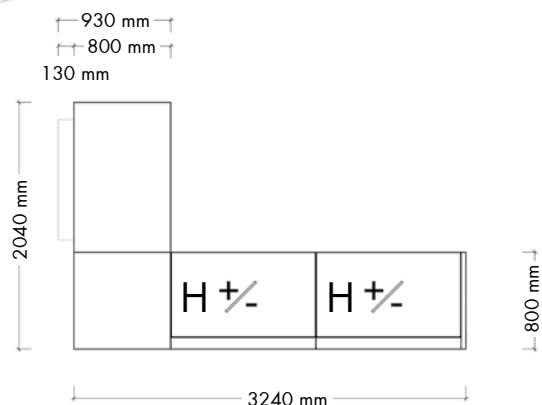

Rectangular height adjustable, corner and rectangular counters (with bag shelf)

Components	Article no.	Price EUR	Quantity	EUR
Left side panel for height adjustable counter (H740 mm)	BI3804303	311,89	1	311,89
Height adjustable counter - starter, middle and end (W1200 mm)	BI24015006	3.889,98	2	7.779,96
Wooden front panel for height adjustable counter (W1200 x H740 mm)	BI350546	544,64	2	1.089,28
Square corner counter top for height adjustable counter on left side	BI26520003	468,43	1	468,43
Middle panel for height adjustable and standard counter (H740 mm)	BI3704193	348,46	1	348,46
Wooden front panel for square corner counter (H740 mm)	BI340346	648,77	1	648,77
Rectangular counter - end (W1240 x H740 mm)	BI2003022003	797,34	1	797,34
Wooden front panel for rectangular counter (W1200 x H740 mm)	BI300546	314,94	1	314,94
Wooden bag shelf for rectangular counter (W1200 mm)	BI81053	204,16	1	204,16
Total price for configuration				11.963,23

Comments to configuration

- Monitor, office chairs and text are not included in price.
- All prices are based on colours and surfaces in price group A, see pages 4-7 for colours.
- We recommend the use of desk grommets, cable rails and drawer pedestals with the Inform counter, see page 113.
- The bag shelf is in fact 1000 mm long, adapted to a 1200 mm front panel.

HEIGHT ADJUSTABLE COUNTER

CONFIGURATION NO. 10

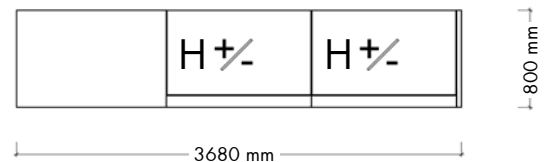

Rectangular height adjustable and rectangular counters (with bag shelves)

Components	Article no.	Price EUR	Quantity	EUR
Left side panel for height adjustable counter (H740 mm)	BI3804303	311,89	1	311,89
Height adjustable counter - starter, middle and end (W1200 mm)	BI24015006	3.889,98	2	7.779,96
Wooden front panel for height adjustable counter (W1200 x H740 mm)	BI350546	544,64	2	1.089,28
Middle panel for height adjustable and standard counter (H740 mm)	BI3704193	348,46	1	348,46
Rectangular counter for height adj. counter - end (W1240 x H740 mm)	BI2305022003	797,34	1	797,34
Wooden front panel for rectangular counter (W1200 x H740 mm)	BI300546	314,94	1	314,94
Wooden bag shelf for rectangular counter (W1200 mm)	BI81053	204,16	2	408,32
Total price for configuration				11.050,19

Comments to configuration

- Monitor, display and text are not included in price.
- All prices are based on colours and surfaces in price group A, see pages 4-7 for colours.
- We recommend the use of desk grommets, cable rails and drawer pedestals with the Inform counter, see page 113.
- The bag shelves are in fact 1000 mm long, adapted to 1200 mm front panels.

HEIGHT ADJUSTABLE COUNTER

RECTANGULAR COUNTERS

The height adjustable counter is a double construction with a moveable upper part and a fixed lower part. The moveable part of the counter slides along the walls of the fixed parts excluding possible safety risks such as entrapment and bruising. With the electrical driven height adjustable counter, you can adjust your working height ranging between 680 mm and 1180 mm. To construct a complete counter including a height adjustable counter, you must use the products shown on pages 72-81.

Height adjustable counter

Available in 3 versions:
 (1) for European market,
 (2) for US market 110V
 (3) for UK market.

Side, front and middle panels to be ordered separately. For counter with predrilled holes for cable conduct see pages 120-121.

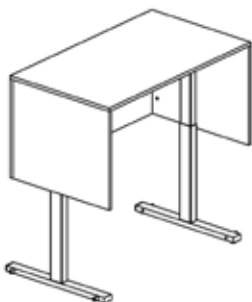

H	x	W	x	D	Item no. Melamine	Price EUR	Item no. Veneer	Price EUR
(1)	680-1180	1000		700	BI24014006	3.831,60	BI25014002	6.310,98
	680-1180	1200		700	BI24015006	3.889,98	BI25015002	6.407,28
	680-1180	1400		700	BI24016006	4.025,38	BI25016002	6.630,18
	680-1180	1600		700	BI24017006	4.071,13	BI25017002	6.705,46
(2)	680-1180	1000		700	BI24024006	3.831,60	BI25024002	6.310,98
	680-1180	1200		700	BI24025006	3.889,98	BI25025002	6.407,28
	680-1180	1400		700	BI24026006	4.025,38	BI25026002	6.630,18
	680-1180	1600		700	BI24027006	4.071,13	BI25027002	6.705,46
(3)	680-1180	1000		700	BI24034006	3.831,60	BI25034002	6.310,98
	680-1180	1200		700	BI24035006	3.889,98	BI25035002	6.407,28
	680-1180	1400		700	BI24036006	4.025,38	BI25036002	6.630,18
	680-1180	1600		700	BI24037006	4.071,13	BI25037002	6.705,46

Wooden front panel for height adjustable counter

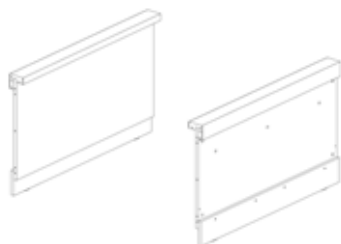

H	x	W	mm	Item no. Melamine	Price EUR	Item no. Veneer	Price EUR
740		1000		BI350446	510,32	BI350442	840,56
740		1200		BI350546	544,64	BI350542	897,09
740		1400		BI350646	574,29	BI350642	946,30
740		1600		BI350746	606,08	BI350742	998,03

Acrylic front panel for height adjustable counter

HPL wooden frame.



H	x	W	mm	Item no. Acrylic & HPL	Price EUR
740		1000		BI360443	822,74
740		1200		BI360543	886,58
740		1400		BI360643	979,28
740		1600		BI360743	1.075,57

HEIGHT ADJUSTABLE COUNTER

FRONT AND SIDE PANELS

Remember to order front and side panels for your height adjustable counter.

Side panel for height adjustable counter - for start/end

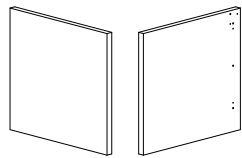
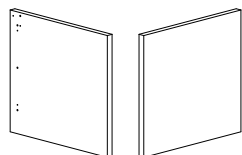
	Side	H mm	Item no. HPL	Price EUR
	Left: No drill holes Right: Height adjustable counter	740	BI3804303	311,89
	Left: Height adjustable counter Right: No drill holes	740	BI3804313	311,89

HEIGHT ADJUSTABLE COUNTER

H740 MM RECTANGULAR COUNTERS FOR HEIGHT ADJUSTABLE COUNTER

If you wish to add a rectangular H740 mm counter to Inform height adjustable counters, you must use the counters shown below. If you wish to add a rectangular H1000 mm counter, see page 22. See overview on page 82 to find the correct middle panel for your construction.

H740 mm rectangular counter for right sided height adjustable counter - starter

Left side: Starter Right side: Height adjustable Use with middle panel BI3704193, see page 82. Remember to order front panel, see next page. For counters with predrilled holes for cable conduct, see pages 120-121.	H x W x D mm	Item no. HPL	Price EUR
	740 640 800	BI2301016003	677,37
	740 840 800	BI2301018003	701,31
	740 1040 800	BI2301020003	749,32
	740 1240 800	BI2301022003	797,34
	740 1440 800	BI2301024003	857,05
	740 1640 800	BI2301026003	893,23



H740 mm rectangular counter for right sided height adjustable counter - middle

Left side: Rectangular/curved/corner Right side: Height adjustable Use with middle panel BI3704193, see page 82. Remember to order front panel, see next page. For counters with predrilled holes for cable conduct, see pages 120-121.	H x W x D mm	Item no. HPL	Price EUR
	740 640 800	BI2302060003	353,38
	740 840 800	BI2302080003	377,19
	740 1040 800	BI2302081003	425,47
	740 1240 800	BI2302082003	473,48
	740 1440 800	BI2302084003	533,33
	740 1640 800	BI2302086003	569,37



H740 mm rectangular counter for height adjustable counter on both sides

Left side: Height adjustable Right side: Height adjustable Use with two middle panels BI3704183 and BI3704193, see page 82. Remem- ber to order front panel, see next page. For counters with predrilled holes for cable conduct, see pages 120-121.	H x W x D mm	Item no. HPL	Price EUR
	740 600 800	BI2303060003	353,38
	740 800 800	BI2303080003	377,19
	740 1000 800	BI2303081003	425,47
	740 1200 800	BI2303082003	473,48
	740 1400 800	BI2303084003	533,33
	740 1600 800	BI2303086003	569,37



HEIGHT ADJUSTABLE COUNTER

H740 MM RECTANGULAR COUNTERS AND FRONTS FOR HEIGHT ADJUSTABLE COUNTER

If you wish to add a rectangular H740 mm counter to Inform height adjustable counters, you must use the counters shown below. If you wish to add a rectangular H1000 mm counter, see page 22. See overview on page 82 to find the correct middle panel for your construction.

H740 mm rectangular counter for left sided height adjustable counter - middle

Left side: Height adjustable Right side: Rectangular/curved/corner Use with middle panel BI3704183, see page 82. Remember to order front panel, see below. For counters with predrilled holes for cable conduct, see pages 120-121.	H x W x D mm	Item no. HPL	Price EUR
	740 600 800	BI2304060003	353,38
	740 800 800	BI2304080003	377,19
	740 1000 800	BI2304081003	425,47
	740 1200 800	BI2304082003	473,48
	740 1400 800	BI2304084003	533,33
	740 1600 800	BI2304086003	569,37



H740 mm rectangular counter for left sided height adjustable counter - end

Left side: Height adjustable Right side: End Use with middle panel BI3704183, see page 82. Remember to order front panel, see below. For counters with predrilled holes for cable conduct, see pages 120-121.	H x W x D mm	Item no. HPL	Price EUR
	740 640 800	BI2305016003	677,37
	740 840 800	BI2305018003	701,31
	740 1040 800	BI2305020003	749,32
	740 1240 800	BI2305022003	797,34
	740 1440 800	BI2305024003	857,05
	740 1640 800	BI2305026003	893,23

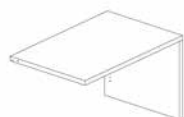

Wooden or acrylic front panel for rectangular counter for height adjustable counter

Wooden: Melaminecoated/veneer. Acrylic: Melaminecoated wooden frame.	H x W mm	Item no. Melamine/veneer	Price EUR	Item no. Acrylic & melamine	Price EUR
	740 600	BI300146	205,22	BI310146	770,07
	740 800	BI300346	235,81	BI310346	792,95
	740 1000	BI300446	283,96	BI310446	886,71
	740 1200	BI300546	314,94	BI310546	933,13
	740 1400	BI300646	348,86	BI310646	1.003,09
	740 1600	BI300746	401,66	BI310746	1.071,18
	740 600	BI300142	337,95		
	740 800	BI300342	388,89		
	740 1000	BI300442	467,76		
	740 1200	BI300542	518,70		
	740 1400	BI300642	574,29		
	740 1600	BI300742	661,28		

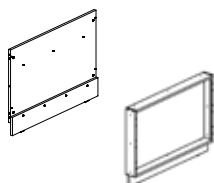

HEIGHT ADJUSTABLE COUNTER

H740 MM 45° CURVED COUNTERS FOR HEIGHT ADJUSTABLE COUNTER

If you wish to add a 45° curved H740 mm counter to Inform height adjustable counters, you must use the counters shown below. If you wish to add a 45° curved H1000 mm counter, see page 24. See overview on page 82 to find the correct middle panel for your construction.

45° curved counter for right sided height adjustable counter - starter

Left side: Starter	H x W x D	Item no.	Price
Right side: Height adjustable	mm	HPL	EUR
Use with middle panel BI3704193, see page 82. Remember to order front panel, see next page. For counters with predrilled holes for cable conduct, see pages 120-121.	740 1835 800	BI2351428003	1.229,32

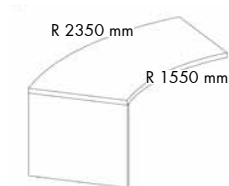

45° curved counter for right sided height adjustable counter - middle

Left side: Rectangular/curved/corner	H x W x D	Item no.	Price
Right side: Height adjustable	mm	HPL	EUR
Use with middle panel BI3704193, see page 82. Remember to order front panel, see next page. For counters with predrilled holes for cable conduct, see pages 120-121.	740 1800 800	BI2352488003	905,46



45° curved counter for height adjustable counter on both sides

Left side: Height adjustable	H x W x D	Item no.	Price
Right side: Height adjustable	mm	HPL	EUR
Use with two middle panels BI3704183 and BI3704193, see page 82. Remember to order front panel, see next page. For counters with predrilled holes for cable conduct, see pages 120-121.	740 1800 800	BI2353488003	1.229,32



HEIGHT ADJUSTABLE COUNTER

H740 MM 45° CURVED COUNTERS AND FRONT PANELS FOR HEIGHT ADJUSTABLE COUNTER

If you wish to add a 45° curved H740 mm counter to Inform height adjustable counters, you must use the counters shown below. If you wish to add a 45° curved H1000 mm counter, see page 24. See overview on page 82 to find the correct middle panel for your construction.

45° curved counter for left sided height adjustable counter - middle

Left side: Height adjustable Right side: Rectangular/curved/corner Use with middle panel BI3704183, see page 82. Remember to order front panel, see below. For counters with predrilled holes for cable conduct, see pages 120-121.	H x W x D mm	Item no. HPL	Price EUR
	740 1800 800	BI2354488003	905,46



45° curved counter for left sided height adjustable counter - end

Left side: Height adjustable Right side: End Use with middle panel BI3704183, see page 82. Remember to order front panel, see below. For counters with predrilled holes for cable conduct, see pages 120-121.	H x W x D mm	Item no. HPL	Price EUR
	740 1835 800	BI2355428003	1.229,32

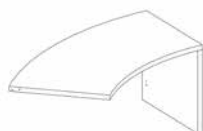

Wooden or acrylic front panel for 45° curved counter

Wooden: High pressure laminate (HPL) Acrylic: Melaminecoated wooden frame.	H x W mm	Item no. HPL	Price EUR	Item no. Acrylic & melamine	Price EUR
	740 1760	BI3204543	2.104,06	BI3304546	1.509,68

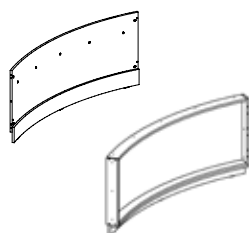

HEIGHT ADJUSTABLE COUNTER

H740 MM 90° CURVED COUNTERS FOR HEIGHT ADJUSTABLE COUNTER

If you wish to add a 90° curved H740 mm counter to Inform height adjustable counters, you must use the counters shown below. If you wish to add a 90° curved H1000 mm counter, see page 26. See overview on page 82 to find the correct middle panel for your construction.

90° curved counter for right sided height adjustable counter - starter

Left side: Starter	H x W x D	Item no.	Price
Right side: Height adjustable	mm	HPL	EUR
Use with middle panel BI3704193, see page 82. Remember to order front panel, see next page. For counters with predrilled holes for cable conduct, see pages 120-121.	740 1870 800	BI2351928003	1.325,48

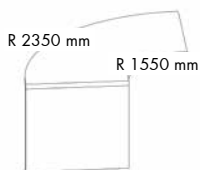

90° curved counter for right sided height adjustable counter - middle

Left side: Rectangular/curved/corner	H x W x D	Item no.	Price
Right side: Height adjustable	mm	HPL	EUR
Use with middle panel BI3704193, see page 82. Remember to order front panel, see next page. For counters with predrilled holes for cable conduct, see pages 120-121.	740 1840 800	BI2352988003	1.001,62



90° curved counter for height adjustable counter on both sides

Left side: Height adjustable	H x W x D	Item no.	Price
Right side: Height adjustable	mm	HPL	EUR
Use with two middle panels BI3704183 and BI3704193, see page 82. Remember to order front panel, see next page. For counters with predrilled holes for cable conduct, see pages 120-121.	740 1840 800	BI2353988003	1.325,48



HEIGHT ADJUSTABLE COUNTER

H740 MM 90° CURVED COUNTERS AND FRONT PANELS FOR HEIGHT ADJUSTABLE COUNTER

If you wish to add a 90° curved H740 mm counter to Inform height adjustable counters, you must use the counters shown below. If you wish to add a 90° curved H1000 mm counter, see page 26. See overview on page 82 to find the correct middle panel for your construction.

90° curved counter for left sided height adjustable counter - middle

Left side: Height adjustable Right side: Rectangular/curved/corner Use with middle panel BI3704183, see page 82. Remember to order front panel, see below. For counters with predrilled holes for cable conduct, see pages 120-121.	H x W x D mm	Item no. HPL	Price EUR
	740 1840 800	BI2354988003	1.001,62

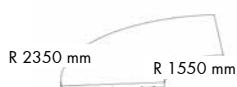

90° curved counter for left sided height adjustable counter - end

Left side: Height adjustable Right side: End Use with middle panel BI3704183, see page 82. Remember to order front panel, see below. For counters with predrilled holes for cable conduct, see pages 120-121.	H x W x D mm	Item no. HPL	Price EUR
	740 1870 800	BI2355928003	1.325,48



Wooden or acrylic front panel for 90° curved counter

Wooden: High pressure laminate (HPL) Acrylic: Melamincoated wooden frame.	H x W mm	Item no. HPL	Price EUR	Item no. Acrylic & melamine	Price EUR
	740 1768	BI3209043	2.139,57	BI3309066	2.074,00

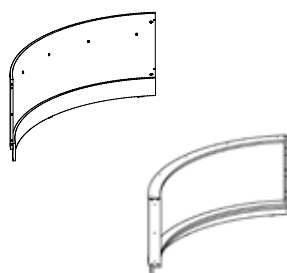

HEIGHT ADJUSTABLE COUNTER

H740 MM 45° CURVED COUNTERS FOR HEIGHT ADJUSTABLE AND RECESSED COUNTER

If you wish to place a 45° curved H740 mm counter in between a height adjustable counter and a recessed counter, you must use the counters shown below.

45° curved counter for right sided height adjustable counter - middle

Left side: Recessed - use with middle panel BI3704103.	H x W x D mm	Item no. HPL	Price EUR
Right side: Height adjustable - use with middle panel BI3704183. Remember to order front panel, see below. For counters with predrilled holes for cable conduct, see pages 120-121.	740 xx 800	BI2362488003	905,46

45° curved counter for left sided height adjustable counter - middle

Left side: Height adjustable - use with middle panel BI3704183.	H x W x D mm	Item no. HPL	Price EUR
Right side: Recessed - use with middle panel BI3704103. Remember to order front panel, see below. For counters with predrilled holes for cable conduct, see pages 120-121.	740 xx 800	BI2364488003	905,46

Wooden or acrylic front panel for 45° curved counter

Wooden: High pressure laminate (HPL) Acrylic: Melaminecoated wooden frame.	H x W mm	Item no. HPL	Price EUR	Item no. Acrylic & melamine	Price EUR
	740 1760	BI3204543	2.104,06	BI3304546	1.509,68

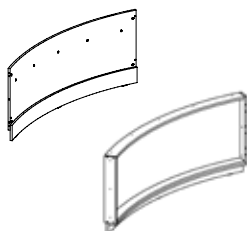

HEIGHT ADJUSTABLE COUNTER

H740 MM 90° CURVED COUNTERS PANELS FOR HEIGHT ADJUSTABLE AND RECESSED COUNTER

If you wish to place a 90° curved H740 mm counter in between a height adjustable counter and a recessed counter, you must use the counters shown below.

90° curved counter for right sided height adjustable counter - middle

Left side: Recessed - use with middle panel BI3704103.	H x W x D mm	Item no. HPL	Price EUR
Right side: Height adjustable - use with middle panel BI3704183. Remember to order front panel, see below. For counters with predrilled holes for cable conduct, see pages 120-121.	740 xx 800	BI2362988003	1.001,62

90° curved counter for left sided height adjustable counter - middle

Left side: Height adjustable - use with middle panel BI3704183.	H x W x D mm	Item no. HPL	Price EUR
Right side: Recessed - use with middle panel BI3704103. Remember to order front panel, see below. For counters with predrilled holes for cable conduct, see pages 120-121.	740 xx 800	BI2364988003	1.001,62

Wooden or acrylic front panel for 90° curved counter

Wooden: High pressure laminate (HPL) Acrylic: Melaminecoated wooden frame.	H x W mm	Item no. HPL	Price EUR	Item no. Acrylic & melamine	Price EUR
	740 1768	BI3209043	2.139,57	BI3309066	2.074,00

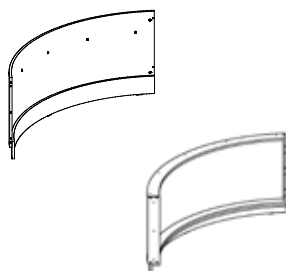

HEIGHT ADJUSTABLE COUNTER

SQUARE CORNER COUNTER FOR HEIGHT ADJUSTABLE COUNTER

If you wish to add a square corner counter to Inform height adjustable counters, you must use the counters shown below. See overview on page 82 to find the correct middle panel for your construction.

Square corner counter top for right sided height adjustable counter

Left side: Rectangular Right side: Height adjustable Use with middle panel BI3704193, see page 82. Remember to order front panel, see below. For counters with predrilled holes for cable conduct, see pages 108- 109.	H x W x D mm	Item no. HPL	Price EUR
	740 800 800	BI26510003	468,43



Square corner counter top for left sided height adjustable counter

Left side: Height adjustable Right side: Rectangular Use with middle panel BI3704183, see page 82. Remember to order front panel, see below. For counters with predrilled holes for cable conduct, see pages 120-121.	H x W x D mm	Item no. HPL	Price EUR
	740 800 800	BI26520003	468,43



Wooden front panel for square corner counter

H x W x D mm	Item no. Melamine	Price EUR	Item no. Veneer	Price EUR
740 800 800	BI340346	648,77	BI340342	1.068,66

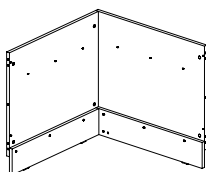

HEIGHT ADJUSTABLE COUNTER

TRIANGULAR CORNER COUNTER FOR HEIGHT ADJUSTABLE COUNTER

If you wish to add a triangular corner counter to Inform height adjustable counters, you must use the counters shown below. See overview on page 82 to find the correct middle panel for your construction.

Triangular corner counter top for right sided height adjustable counter

Left side: Rectangular Right side: Height adjustable Use with middle panel BI3704193 (see page 82. Remember to order front panel, see below. For counters with predrilled holes for cable conduct, see pages 120-121.	H x W x D mm	Item no. HPL	Price EUR
	740 800 800	BI26813003	505,93

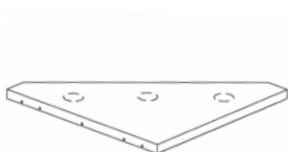

Triangular corner counter top for left sided height adjustable counter

Left side: Height adjustable Right side: Rectangular Use with middle panel BI3704183, see page 82. Remember to order front panel, see below. For counters with predrilled holes for cable conduct, see pages 120-121.	H x W x D mm	Item no. HPL	Price EUR
	740 800 800	BI26823003	505,93

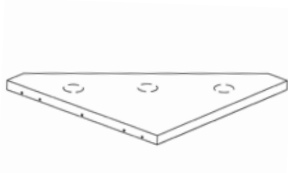

Wooden front panel for triangular corner counter

Remember to order leg frame.	H x W x D mm	Item no. Melamine	Price EUR	Item no. Veneer	Price EUR
	740 800 800	BI345346	473,75	BI345342	780,05

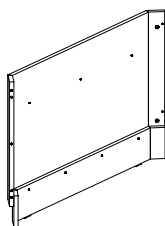

HEIGHT ADJUSTABLE COUNTERS

MIDDLE PANELS

It is necessary to order side and middle panels for the height adjustable counter BI240, depending on the construction of your complete counter. See overview of middle panels below. Note - do not place more than 2 height adjustable counters next to each other and remember always to construct your counter from left to right when sitting behind the counter.

Middle panel for height adjustable and rectangular/curved/corner counters, see pages 72-79

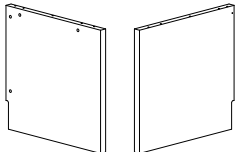
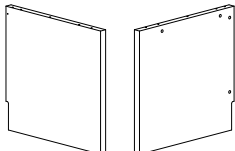
Side of panel	H mm	Item no. HPL	Price EUR
 <p>Left: H740 mm rectangular/curved/corner for height adjustable counter Right: Height adjustable counter</p>	740	BI3704183	348,46
 <p>Left: Height adjustable counter Right: H740 mm rectangular/curved/corner for height adjustable counter</p>	740	BI3704193	348,46

Middle panel for height adjustable and recessed counter, see pages 38-50

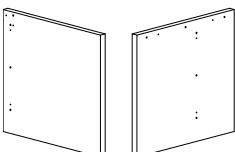
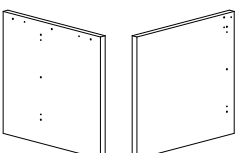
Side of panel	H mm	Item no. HPL	Price EUR
 <p>Left: Height adjustable counter Right: Recessed counter</p>	740	BI3704163	170,37
 <p>Left: Recessed counter Right: Height adjustable counter</p>	740	BI3704173	170,37

Middle panel for height adjustable and step counter, see pages 54-56

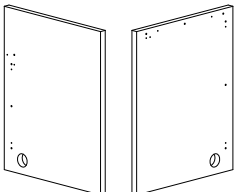
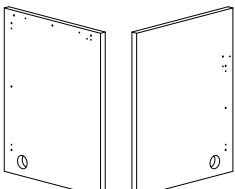
Side of panel	H mm	Item no. HPL	Price EUR
 <p>Left: Height adjustable counter Right: Rectangular/step counter (1000 mm)</p>	1000	BI3706203	348,46
 <p>Left: Rectangular/step counter (1000 mm) Right: Height adjustable counter</p>	1000	BI3706213	348,46

HEIGHT ADJUSTABLE COUNTER

CONFIGURATIONS

It is necessary to order side and middle panels for the height adjustable counter BI240, depending on the construction of your complete counter. See overview of middle panels on page 82. Note - do not place more than 2 height adjustable counters next to each other and remember always to construct your counter from left to right when sitting behind the counter.

Rectangular and height adjustable counter

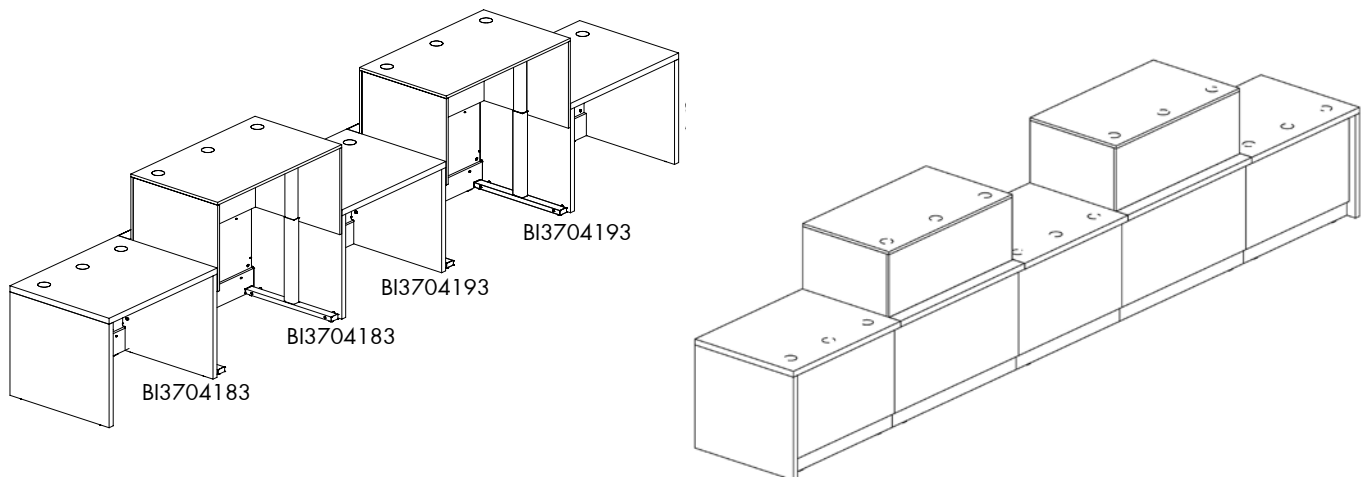

Recessed rectangular and height adjustable counter

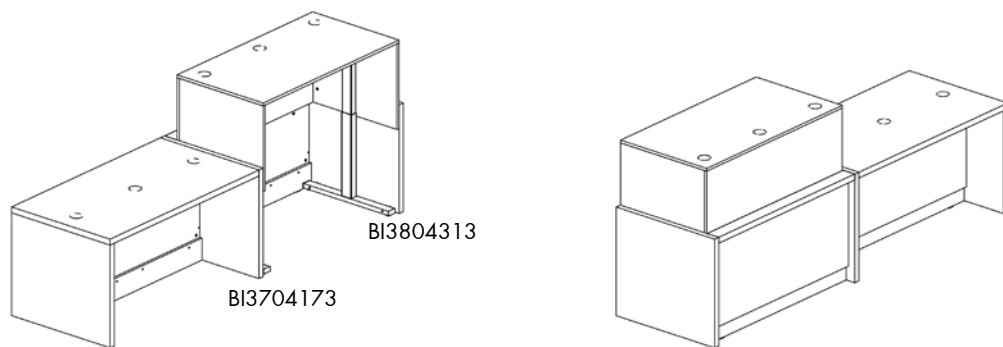

Special rectangular, height adjustable, corner and info counters

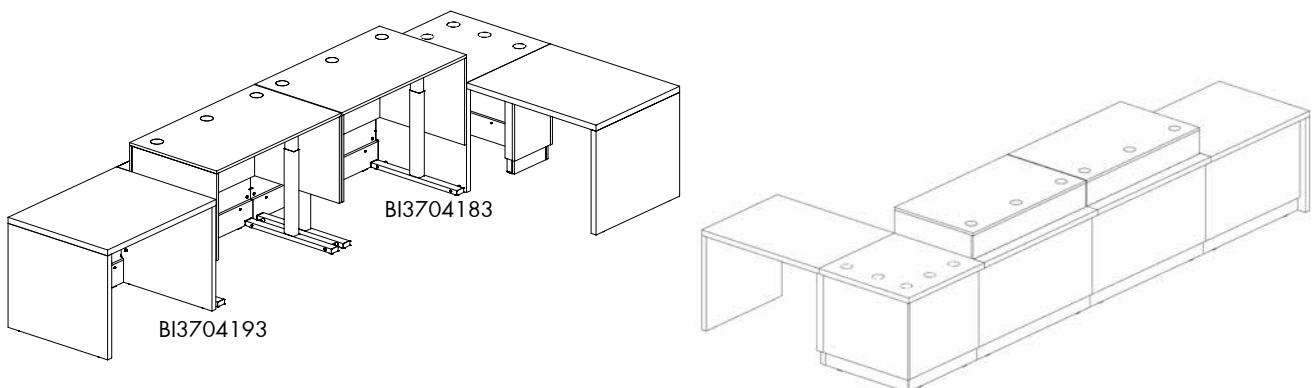

COUNTER SHELF

STANDARD AND SPECIAL SOLUTIONS

COUNTER SHELVES FOR VARIOUS COUNTERS

When ordering freestanding counter shelf for your counter, please note the following:

A freestanding counter shelf has (equal to a freestanding counter) 40 mm end panels on both sides. The front of the counter shelf has the same measurement as the counter below. This means that if you place a freestanding counter shelf (with two end panels) on a counter built up of two modules, the end panel of the counter shelf will be placed on the top of the adjacent counter.

It is possible to construct a freestanding counter shelf that fits on the counters below, (see 3 options below), but this must be specially requested. Contact customer service for details.

STANDARD

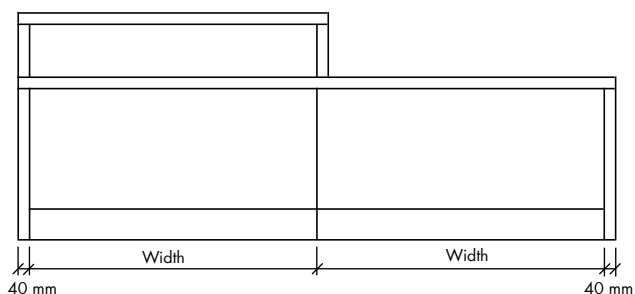

SPECIAL SOLUTION 1

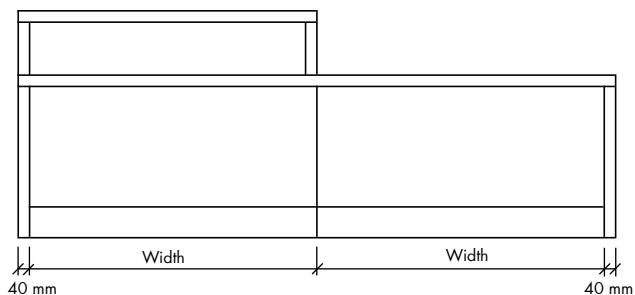

SPECIAL SOLUTION 2

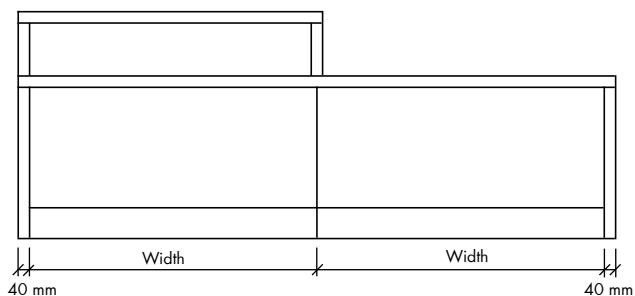

SPECIAL SOLUTION 3

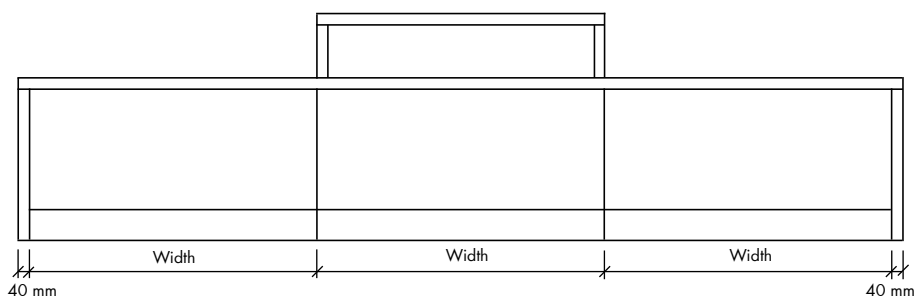

COUNTER SHELF

CONFIGURATION NO. 15



Rectangular & square corner counters (with counter shelves and bag shelves)

Components	Article no.	Price EUR	Quantity	EUR
Rectangular counter - starter (W1240 x H740 mm)	BI2001022003	797,34	1	797,34
Rectangular counter - middle (W1200 x H740 mm)	BI2002082003	497,42	1	497,42
Rectangular counter - end (W1240 x H740 mm)	BI2003022003	797,34	1	797,34
Square corner counter top (H740 mm)	BI26530003	455,79	1	455,79
Wooden front panel for rectangular counter (W1200 x H740 mm)	BI300546	314,94	2	629,88
Acrylic front panel for rectangular counter (W1200 x H740 mm)	BI310546	933,13	1	933,13
Wooden front panel for square corner counter (H740 mm)	BI340346	648,77	1	648,77
Wooden bag shelf for rectangular counter (W1200 mm)	BI81053	204,16	2	408,32
Counter shelf and front for rectangular counter - starter (W1240 mm)	BI4101056	510,99	1	510,99
Counter shelf and front for rectangular counter - end (W1240 mm)	BI4103056	510,99	1	510,99
Steel leg frame (H740 mm)	BI069146	379,72	3	1.139,16
Total price for configuration				7.329,13

Comments to configuration

- Office chair, monitors, Puppy and text are not included in price.
- All prices are based on colours and surfaces in price group A, see pages 4-7 for colours.
- We recommend the use of desk grommets, cable rails and drawer pedestals with the Inform counter, see page 113.
- The bag shelf is in fact 1000 mm long, adapted to a 1200 mm front panel.

COUNTER SHELF

CONFIGURATION NO. 16

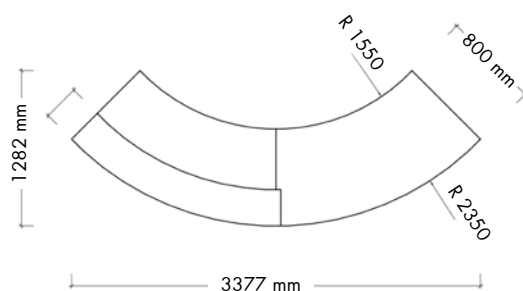

45° curved counters (with counter shelf)

Components	Article no.	Price EUR	Quantity	EUR
45° curved counter - starter (H740 mm)	BI2051428003	1.229,32	1	1.229,32
45° curved counter - end (H740 mm)	BI2053428003	1.229,32	1	1.229,32
Wooden front panel for 45° curved counter (H740 mm)	BI3204543	2.104,06	2	4.208,12
Steel leg frame (H740 mm)	BI069146	379,72	1	379,72
Counter shelf with front panel for 45° counter - freestanding	BI431443	1.372,16	1	1.372,16
Total price for configuration				8.418,64

Comments to configuration

- Monitor and text are not included in price.
- All prices are based on colours and surfaces in price group A, see pages 4-7 for colours.
- We recommend the use of desk grommets, cable rails and drawer pedestals with the Inform counter, see page 113.

COUNTER SHELF

CONFIGURATION NO. 17

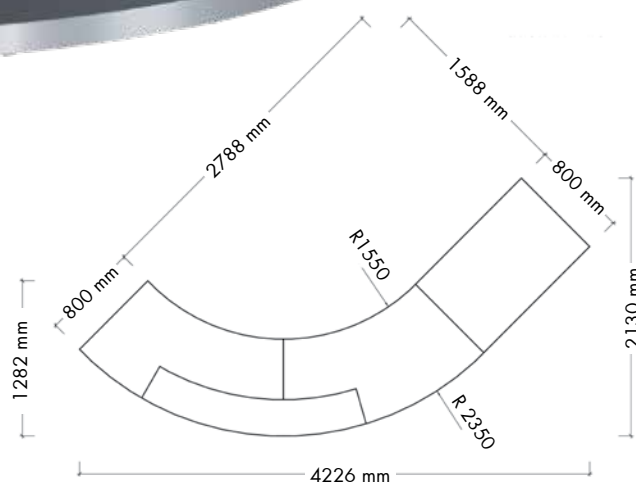

45° curved and rectangular counters (with counter shelf)

Components	Article no.	Price EUR	Quantity	EUR
Rectangular counter - starter (W1240 x H740 mm)	BI2001022003	797,34	1	797,34
45° curved counter - middle (H740 mm)	BI2052488003	905,46	1	905,46
45° curved counter - end (H740 mm)	BI2053428003	1.229,32	1	1.229,32
Wooden front panel for rectangular counter (W1200 x H740 mm)	BI300546	314,94	1	314,94
Wooden front panel for 45° curved counter (H740 mm)	BI3204543	2.104,06	2	4.208,12
Steel leg frame (H740 mm)	BI069146	379,72	2	759,44
Counter shelf with front panel for 45° counter - freestanding	BI431443	1.372,16	1	1.372,16
Total price for configuration				9.586,78

Comments to configuration

- Monitor and text are not included in price.
- All prices are based on colours and surfaces in price group A, see pages 4-7 for colours.
- We recommend the use of desk grommets, cable rails and drawer pedestals with the Inform counter, see page 113.

COUNTER SHELF

COUNTER SHELVES FOR RECTANGULAR COUNTERS

Create a private working space by adding a counter shelf to your standard rectangular counter. It has both practical and optical advantages.

Wooden counter shelf with front panel for rectangular counter - starter

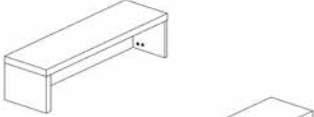
High pressure laminate (HPL) counter shelf and melamine coated/veneer front panel.	H x W x D mm	Item no. HPL & melamine	Price EUR	Item no. HPL & veneer	Price EUR
	260 640 300	BI4101016	415,89	BI4151012	685,08
	260 840 300	BI4101036	438,77	BI4151032	722,99
	260 1040 300	BI4101046	486,91	BI4151042	802,12
	260 1240 300	BI4101056	510,99	BI4151052	841,49
	260 1440 300	BI4101066	535,06	BI4151062	881,26
	260 1640 300	BI4101076	570,84	BI4151072	940,04

Wooden counter shelf with front panel for rectangular counter - middle

High pressure laminate (HPL) counter shelf and melamine coated/veneer front panel.	H x W x D mm	Item no. HPL & melamine	Price EUR	Item no. HPL & veneer	Price EUR
	260 640 300	BI4102016	415,89	BI4152012	685,08
	260 840 300	BI4102036	438,77	BI4152032	722,99
	260 1040 300	BI4102046	486,91	BI4152042	802,12
	260 1240 300	BI4102056	510,99	BI4152052	841,49
	260 1440 300	BI4102066	535,06	BI4152062	881,26
	260 1640 300	BI4102076	570,84	BI4152072	940,04

Wooden counter shelf with front panel for rectangular counter - end

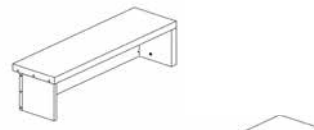
High pressure laminate (HPL) counter shelf and melamine coated/veneer front panel.	H x W x D mm	Item no. HPL & melamine	Price EUR	Item no. HPL & veneer	Price EUR
	260 640 300	BI4103016	415,89	BI4153012	685,08
	260 840 300	BI4103036	438,77	BI4153032	722,99
	260 1040 300	BI4103046	486,91	BI4153042	802,12
	260 1240 300	BI4103056	510,99	BI4153052	841,49
	260 1440 300	BI4103066	535,06	BI4153062	881,26
	260 1640 300	BI4103076	570,84	BI4153072	783,50

Wooden counter shelf with front panel for rectangular counter - freestanding

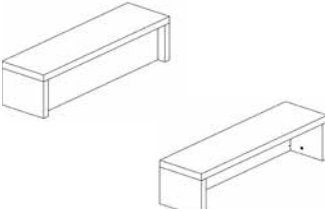
High pressure laminate (HPL) counter shelf and melamine coated/veneer front panel.	H x W x D mm	Item no. HPL & melamine	Price EUR	Item no. HPL & veneer	Price EUR
	260 680 300	BI4104016	415,89	BI4154012	685,08
	260 880 300	BI4104036	438,77	BI4154032	722,99
	260 1080 300	BI4104046	486,91	BI4154042	802,12
	260 1280 300	BI4104056	510,99	BI4154052	841,49
	260 1480 300	BI4104066	535,06	BI4154062	881,26
	260 1680 300	BI4104076	570,84	BI4154072	940,04

COUNTER SHELF

COUNTER SHELVES FOR CORNER COUNTERS

Create a private working space by adding a counter shelf to your standard corner counter. It has both practical and optical advantages.

Wooden counter shelf with front panel for corner counter - starter

High pressure laminate (HPL) counter shelf and melamine coated/veneer front panel.	H x W x D mm	Item no. HPL & melamine	Price EUR	Item no. HPL & veneer	Price EUR
	260 800 300	BI4201036	743,74	BI4251032	1.224,93

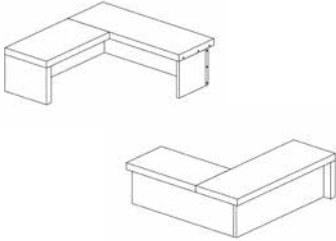

Wooden counter shelf with front panel for corner counter - middle

High pressure laminate (HPL) counter shelf and melamine coated/veneer front panel.	H x W x D mm	Item no. HPL & melamine	Price EUR	Item no. HPL & veneer	Price EUR
	260 800 300	BI4202036	743,74	BI4252032	1.224,93

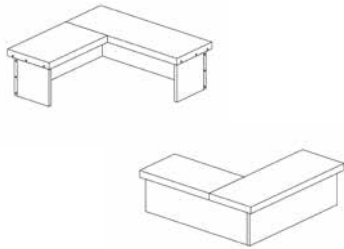

Wooden counter shelf with front panel for corner counter - end

High pressure laminate (HPL) counter shelf and melamine coated/veneer front panel.	H x W x D mm	Item no. HPL & melamine	Price EUR	Item no. HPL & veneer	Price EUR
	260 800 300	BI4203036	743,74	BI4253032	1.224,93

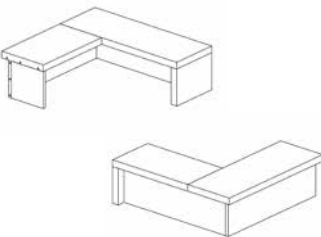

Wooden counter shelf with front panel for corner counter - freestanding

High pressure laminate (HPL) counter shelf and melamine coated/veneer front panel.	H x W x D mm	Item no. HPL & melamine	Price EUR	Item no. HPL & veneer	Price EUR
	260 800 300	BI4204036	743,74	BI4254032	1.224,93

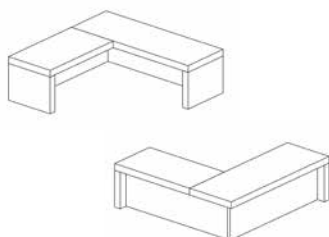

COUNTER SHELF

COUNTER SHELVES FOR 45° COUNTER

Create a private working space by adding a counter shelf to your curved counter. It has both practical and optical advantages.

Wooden counter shelf with front panel for 45° counter - starter

High pressure laminate (HPL) counter shelf and HPL/veneer front panel.	H x D mm	Item no. HPL	Price EUR	Item no. HPL & veneer	Price EUR
	260 300	BI431143	1.372,16	BI435142	1.646,54

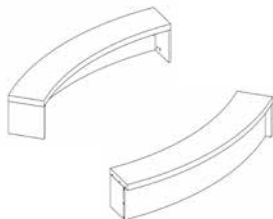

Wooden counter shelf with front panel for 45° counter - middle

High pressure laminate (HPL) counter shelf and HPL/veneer front panel.	H x D mm	Item no. HPL	Price EUR	Item no. HPL & veneer	Price EUR
	260 300	BI431243	1.372,16	BI435242	1.646,54

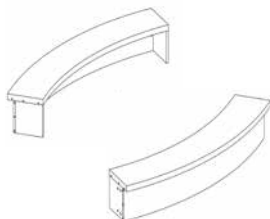

Wooden counter shelf with front panel for 45° counter - end

High pressure laminate (HPL) counter shelf and HPL/veneer front panel.	H x D mm	Item no. HPL	Price EUR	Item no. HPL & veneer	Price EUR
	260 300	BI431343	1.372,16	BI435342	1.646,54

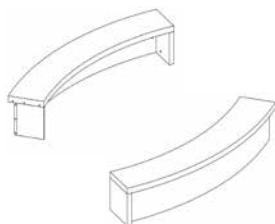

Wooden counter shelf with front panel for 45° counter - freestanding

High pressure laminate (HPL) counter shelf and HPL/veneer front panel.	H x D mm	Item no. HPL	Price EUR	Item no. HPL & veneer	Price EUR
	260 300	BI431443	1.372,16	BI435442	1.646,54

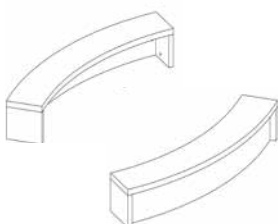

COUNTER SHELF

COUNTER SHELVES FOR 90° COUNTER

Create a private working space by adding a counter shelf to your curved counter. It has both practical and optical advantages.

Wooden counter shelf with front panel for 90° counter- starter

High pressure laminate (HPL) counter shelf and HPL/veneer front panel.	H x D mm	Item no. HPL	Price EUR	Item no. HPL & veneer	Price EUR
	260 300	BI431193	1.372,16	BI435192	1.646,54

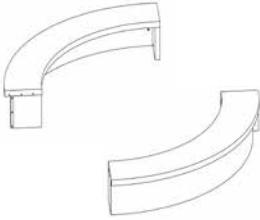

Wooden counter shelf with front panel for 90° counter - middle

High pressure laminate (HPL) counter shelf and HPL/veneer front panel.	H x D mm	Item no. HPL	Price EUR	Item no. HPL & veneer	Price EUR
	260 300	BI431293	1.372,16	BI435292	1.646,54

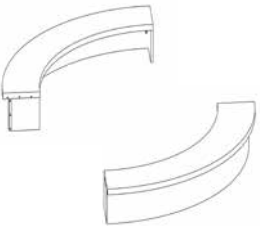

Wooden counter shelf with front panel for 90° counter - end

High pressure laminate (HPL) counter shelf and HPL/veneer front panel.	H x D mm	Item no. HPL	Price EUR	Item no. HPL & veneer	Price EUR
	260 300	BI431393	1.372,16	BI435392	1.646,54

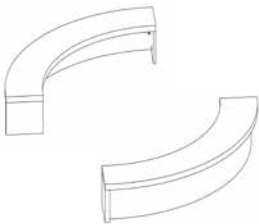

Wooden counter shelf with front panel for 90° counter - freestanding

High pressure laminate (HPL) counter shelf and HPL/veneer front panel.	H x D mm	Item no. HPL	Price EUR	Item no. HPL & veneer	Price EUR
	260 300	BI431493	1.372,16	BI435492	1.646,54

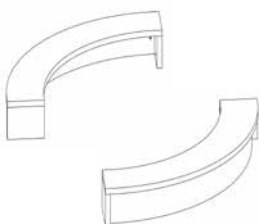

DISPLAY AND STORAGE

CONFIGURATION NO. 18

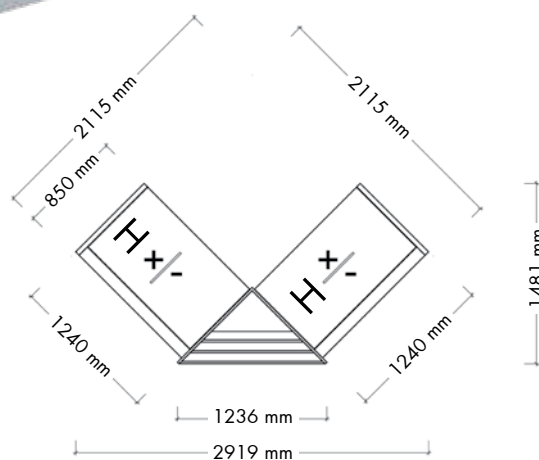

Rectangular height adjustable counters and corner display unit

Components	Article no.	Price EUR	Quantity	EUR
Left side panel for height adjustable counter (H740 mm)	BI3804303	311,89	1	311,89
Height adjustable counter - starter, middle and end (W1200 mm)	BI24015006	3.889,98	2	7.779,96
Acrylic front panel for height adjustable counter (W1200 x H740 mm)	BI360543	886,58	2	1.773,16
Corner display unit (H870 mm)	BI5105336	2.339,74	1	2.339,74
Right side panel for height adjustable counter (H740 mm)	BI3804313	311,89	1	311,89
Total price for configuration				12.516,64

Comments to configuration

- Monitor, display and text are not included in price.
- All prices are based on colours and surfaces in price group A, see pages 4-7 for colours.
- We recommend the use of desk grommets, cable rails and drawer pedestals with the Inform counter, see page 113.

DISPLAY AND STORAGE

CORNER DISPLAY UNITS

This is a slender corner solution with a presentation function towards the customer. The front-side shelves provide perfect storage for loose pamphlets, as well as for books and DVD's. The display unit also structures your counter and offers space e.g. book stands at standing height. The display units are ready for direct integration into all parts of the Inform counter. When constructing your counter, remember always to construct your counter from left to right when sitting behind the counter!

H870 mm - corner display unit

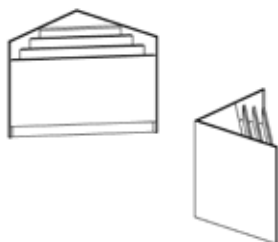

H	x	W	x	Front	Item no.	Price	Item no.	Price
mm		mm			Melamine	EUR	Veneer	EUR
870		875		1200	BI5105006	2.318,59	BI5105002	3.819,10

To have the correct positioning of drill holes in combination with other counters or cabinets, you must use the following in the article number:

		Left panel	Right panel
No drill holes for connecting fittings	BI5105	0	0
Drill holes for counter height 740 mm	BI5105	2	2
Drill holes for height adjustable counter	BI5105	3	3
Drill holes for recessed counter	BI5105	4	4

H1130 mm - corner display unit

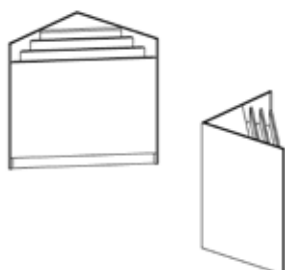

H	x	W	x	Front	Item no.	Price	Item no.	Price
mm		mm			Melamine	EUR	Veneer	EUR
1130		875		1200	BI5107006	2.365,94	BI5107002	3.897,30

To have the correct positioning of drill holes in combination with other counters or cabinets, you must use the following in the article number:

		Left panel	Right panel
No drill holes for connecting fittings	BI5107	0	0
Drill holes for standing height 1000 mm	BI5107	1	1
Drill holes for counter height 740 mm	BI5107	2	2
Drill holes for height adjustable counter	BI5107	3	3
Drill holes for recessed counter	BI5107	4	4

DISPLAY AND STORAGE

CONFIGURATION NO. 19

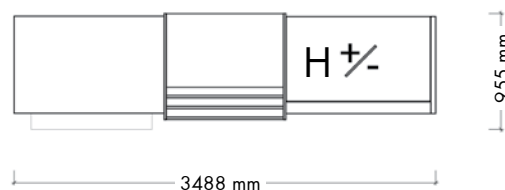

Rectangular height adjustable and rectangular counters with display cabinet

Components	Article no.	Price EUR	Quantity	EUR
Left side panel for height adjustable counter (H740 mm)	BI3804303	311,89	1	311,89
Height adjustable counter - starter, middle and end (W1200 mm)	BI24015006	3.889,98	1	3.889,98
Wooden front panel for height adjustable counter (W1200 x H740 mm)	BI350546	544,64	1	544,64
Display cabinet with shelves & pamphlet display (W1008 x H870 mm)	BI515115006	1.434,80	1	1.434,80
Rectangular counter - end (W1240 x H740 mm)	BI2003022003	797,34	1	797,34
Wooden front panel for rectangular counter (W1200 x H740 mm)	BI300546	314,94	1	314,94
Wooden bag shelf for rectangular counter (W1200 mm)	BI81053	204,16	1	204,16
Total price for configuration				7.497,75

Comments to configuration

- Monitor and text are not included in price.
- All prices are based on colours and surfaces in price group A, see pages 4-7 for colours.
- We recommend the use of desk grommets, cable rails and drawer pedestals with the Inform counter, see page 113.
- The bag shelf is in fact 1000 mm long, adapted to a 1200 mm front panel.

DISPLAY AND STORAGE

DISPLAY CABINETS WITH STORAGE

This is a cabinet with double function: Display at the front and cabinet at the back! Inserted shelves at the front provide perfect storage for loose pamphlets, as well as for books and DVD's. The cabinet offers practical additional surface when standing behind the counter and comes in different heights and widths. The cabinets are ready for direct integration with rectangular, curved and height adjustable counters. The open back of the cabinet can be equipped with lockable doors.

H870 mm - display cabinet with shelves at the back and pamphlet display in front

With bottom shelf and one middle shelf at the back. Doors can be installed on back of display cabinet, see page 100.

H x W x D mm	Item no. Melamine	Price EUR	Item no. Veneer	Price EUR
870 758 875	BI515715006	1.323,08	BI515715002	2.179,34
870 908 875	BI515915006	1.380,01	BI515915002	2.273,10
870 1008 875	BI515115006	1.434,80	BI515115002	2.363,28

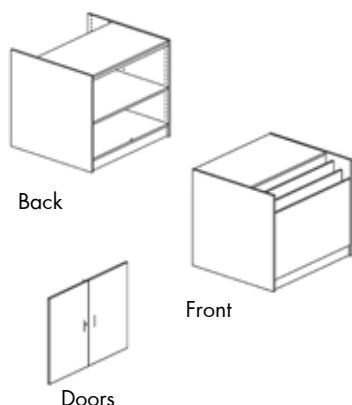

To have the correct positioning of drill holes in combination with other counters or cabinets, you must use the following in the article number:

		Left panel	Right panel
No drill holes for connecting fittings	BI515715	0	0
Drill holes for counter height 740 mm	BI515715	2	2
Drill holes for height adjustable counter	BI515715	3	3
Drill holes for recessed counter	BI515715	4	4

H1130 mm - display cabinet with shelves at the back and pamphlet display in front

With bottom shelf and two middle shelves at the back. Doors can be installed on back of display cabinet, see page 100.

H x W x D mm	Item no. Melamine	Price EUR	Item no. Veneer	Price EUR
1130 758 875	BI515727006	1.323,08	BI515727002	2.179,34
1130 908 875	BI515927006	1.710,11	BI515927002	2.816,81
1130 1008 875	BI515127006	1.774,35	BI515127002	2.922,81

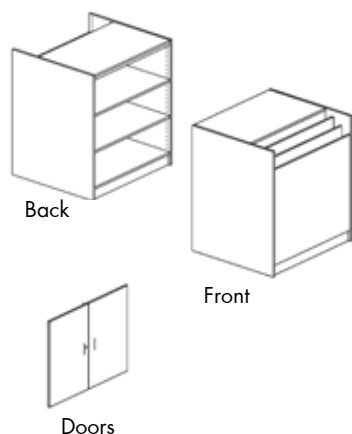

To have the correct positioning of drill holes in combination with other counters or cabinets, you must use the following in the article number:

		Left panel	Right panel
No drill holes for connecting fittings	BI515727	0	0
Drill holes for standing height 1000 mm	BI515727	1	1
Drill holes for counter height 740 mm	BI515727	2	2
Drill holes for height adjustable counter	BI515727	3	3
Drill holes for recessed counter	BI515727	4	4

DISPLAY AND STORAGE

CONFIGURATION NO. 20

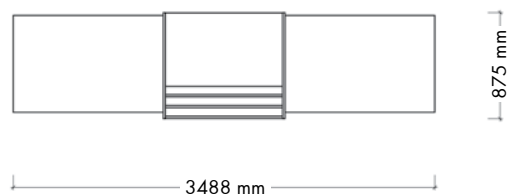

Rectangular counters with display cabinet with drawers

Components	Article no.	Price EUR	Quantity	EUR
Rectangular counter - starter (W1240 x H740 mm)	BI2001022003	797,34	1	797,34
Rectangular counter - end (W1240 x H740 mm)	BI2003022003	797,34	1	797,34
Wooden front panel for rectangular counter (W1200 x H740 mm)	BI300546	314,94	2	629,88
Display cabinet with drawers & pamphlet display (W865 x H870 mm)	BI520943006	2.858,57	1	2.858,57
Total price for configuration				5.083,13

Comments to configuration

- Monitor, drawer pedestal and keyboard are not included in price.
- All prices are based on colours and surfaces in price group A, see pages 4-7 for colours.
- We recommend the use of desk grommets, cable rails and drawer pedestals with the Inform counter, see page 113.

DISPLAY AND STORAGE

DISPLAY CABINETS WITH DRAWERS

This is a cabinet similar to the display cabinet with storage: It has the same front display, but with drawers at the back. Inserted shelves at the front provide perfect storage for loose pamphlets, as well as for books and DVD's. The drawers at the back are designed for organising different media by use of mobile dividers. The drawers are lockable and with drawer stop, which prevents the cabinet from tilting, when several drawers are open at the same time.

H895 mm - display cabinet with drawers at the back and pamphlet display in front

With 4 drawers. See page 100 for accessories for drawers.

H x W x D mm	Item no. Melamine	Price EUR	Item no. Veneer	Price EUR
895 865 894	BI520943006	2.858,57	BI520943002	4.708,47

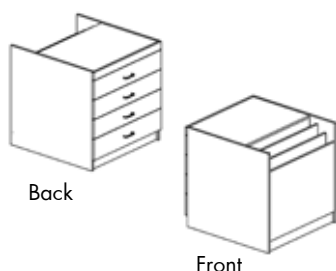

To have the correct positioning of drill holes in combination with other counters or cabinets, you must use the following in the article number:

	Left panel	Right panel
No drill holes for connecting fittings	0	0
Drill holes for counter height 740 mm	2	2
Drill holes for height adjustable counter	3	3
Drill holes for recessed counter	4	4

H1130 mm - display cabinet with drawers at the back and pamphlet display in front

With 5 drawers. See page 100 for accessories for drawers.

H x W x D mm	Item no. Melamine	Price EUR	Item no. Veneer	Price EUR
1130 865 894	BI520957006	3.016,71	BI520957002	4.969,15

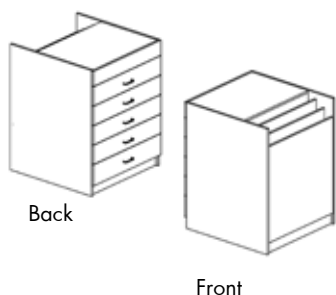

To have the correct positioning of drill holes in combination with other counters or cabinets, you must use the following in the article number:

	Left panel	Right panel
No drill holes for connecting fittings	0	0
Drill holes for standing height 1000 mm	1	1
Drill holes for counter height 740 mm	2	2
Drill holes for height adjustable counter	3	3
Drill holes for recessed counter	4	4

DISPLAY AND STORAGE

DISPLAY CABINETS WITH SHELVES AND SHELVING OPTIONS

Another cabinet with double function: Optional front display shelves and storage at the back! The front-side shelves (not included in price of cabinet) can be adjusted and can also be tilted for presenting your new acquisitions. With different heights and widths, the cabinets are ready for direct integration with rectangular, curved and height adjustable counters. The open back of the cabinet can be equipped with lockable doors.

H870 mm - display cabinet with shelves at the back and shelving options in the front

With bottom shelf and one middle shelf at the back. Front shelves are not included. Doors can be installed on back of display cabinet. See pages 100-101 for doors and shelves.

H x W x D mm	Item no. Melamine	Price EUR	Item no. Veneer	Price EUR
870 758 875	BI525715006	1.154,04	BI525715002	1.900,57
870 908 875	BI525915006	1.209,50	BI525915002	1.992,21
870 1008 875	BI525115006	1.290,10	BI525115002	2.124,81

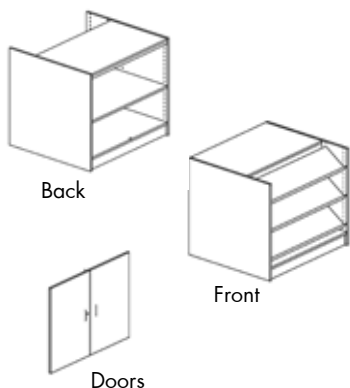

To have the correct positioning of drill holes in combination with other counters or cabinets, you must use the following in the article number:

		Left panel	Right panel
No drill holes for connecting fittings	BI5255715	0	0
Drill holes for counter height 740 mm	BI5255715	2	2
Drill holes for height adjustable counter	BI5255715	3	3
Drill holes for recessed counter	BI5255715	4	4

H1130 mm - display cabinet with shelves at the back and shelving options in the front

With bottom shelf and two middle shelves at the back. Front shelves are not included. Doors can be installed on back of display cabinet. See pages 100-101 for doors and shelves.

H x W x D mm	Item no. Melamine	Price EUR	Item no. Veneer	Price EUR
1130 758 875	BI525727006	1.286,24	BI525727002	2.118,56
1130 908 875	BI525927006	1.637,76	BI525927032	2.697,77
1130 1008 875	BI525127006	1.702,13	BI525127002	2.803,24

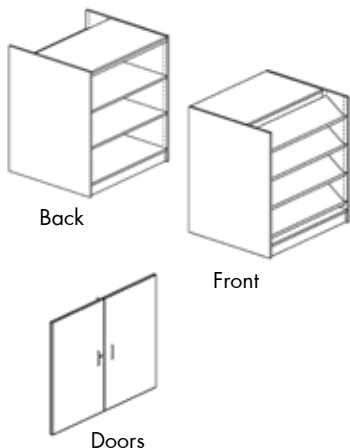

To have the correct positioning of drill holes in combination with other counters or cabinets, you must use the following in the article number:

		Left panel	Right panel
No drill holes for connecting fittings	BI525727	0	0
Drill holes for standing height 1000 mm	BI525727	1	1
Drill holes for counter height 740 mm	BI525727	2	2
Drill holes for height adjustable counter	BI525727	3	3
Drill holes for recessed counter	BI525727	4	4

DISPLAY AND STORAGE

DISPLAY CABINET WITH BOOK TROLLEY GARAGE

Use the space behind your counter - give your book trolley its own parking spot! You will not lose any space when you have the double function cabinet as part of your counter. At the same time, present your books or pamphlets at the front of the cabinet. The cabinets are ready for direct integration with rectangular, curved and height adjustable counters.

H1130 mm - display cabinet with book trolley garage at the back and shelving options in front

Inner dimension of garage: H1080 x W930 x D580 mm. Front shelves are not included, see page 101.

H x W x D mm	Item no. Melamine	Price EUR	Item no. Veneer	Price EUR
1130 1008 875	BI530197006	2.196,50	BI530197002	3.618,00

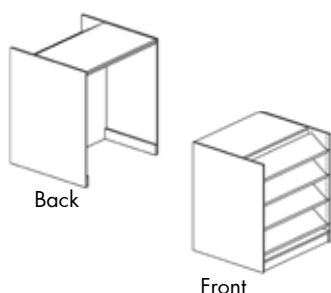

To have the correct positioning of drill holes in combination with other counters or cabinets, you must use the following in the article number:

		Left panel	Right panel
No drill holes for connecting fittings	BI530187	0	0
Drill holes for standing height 1000 mm	BI530187	1	1
Drill holes for counter height 740 mm	BI530187	2	2
Drill holes for height adjustable counter	BI530187	3	3
Drill holes for recessed counter	BI530187	4	4

H1130 mm - display cabinet with book trolley garage at the back and pamphlet display in front

Inner dimension of garage: H1080 x W930 x D580 mm.

H x W x D mm	Item no. Melamine	Price EUR	Item no. Veneer	Price EUR
1130 1008 875	BI530187006	1.716,90	BI530187002	2.827,85

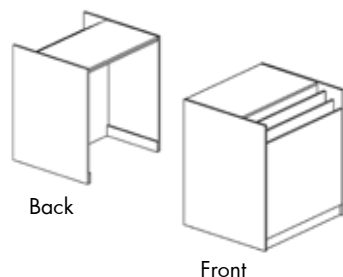

To have the correct positioning of drill holes in combination with other counters or cabinets, you must use the following in the article number:

		Left panel	Right panel
No drill holes for connecting fittings	BI530197	0	0
Drill holes for standing height 1000 mm	BI530197	1	1
Drill holes for counter height 740 mm	BI530197	2	2
Drill holes for height adjustable counter	BI530197	3	3
Drill holes for recessed counter	BI530197	4	4

DISPLAY AND STORAGE

ACCESSORIES

Doors for display cabinet BI515 & BI525

With cylinder lock and door handles.



H x W mm	Item no. Melamine	Price EUR	Item no. Veneer	Price EUR
870 758	BI5407056	568,84	BI5407052	936,85
870 908	BI5409056	616,59	BI5409052	1.015,46
870 1008	BI5401056	664,60	BI5401052	1.094,72
1130 758	BI5407076	616,59	BI5407072	1.015,46
1130 908	BI5409076	664,60	BI5409072	1.094,72
1130 1008	BI5401076	712,88	BI5401072	1.173,99

Drawer organizer for display cabinet BI520

To organise media. Incl. silver coloured steel dividers, two stainless steel rods, mat and four mobile dividers. For approx. 200 CDs in standard cases, 1000 CDs in plastic cases or 90 DVDs.

Description

1 set for 1 drawer
1 additional divider

Item no.

Price
EUR

B4011859
B401186

214,53
18,22

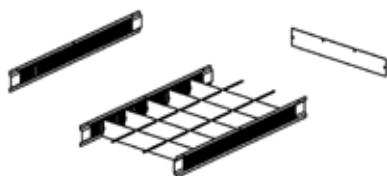

Bracket for sloping wooden and steel shelves

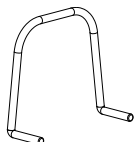

Item no.

Price
EUR

BN066

11,70

DISPLAY AND STORAGE

ACCESSORIES

Wooden shelf with steel backedge for display cabinet BI525 & BI530

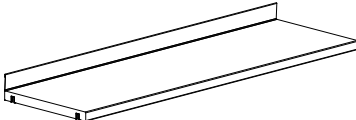
Snapfix incl. Steel backedge H47 mm. When turned, the shelf can be used as a sloping shelf by using the existing pins and bracket BN066.	W x D mm	Type of shelf	Item no.		Price EUR	Price	
			Melamine	Veneer		EUR	EUR
	500	250	Straight	B4018025216	76,74	B4018025212	126,35
	500	300	Sloping	B4018025316	84,85	B4018025312	139,65
	750	250	Straight	B4018027216	81,00	B4018027212	133,53
	750	300	Sloping	B4018027316	89,11	B4018027312	146,70
	900	250	Straight	B4018029216	82,06	B4018029212	135,13
	900	300	Sloping	B4018029316	94,83	B4018029312	156,14
	1000	250	Straight	B4018021216	110,92	B4018021212	182,61
	1000	300	Sloping	B4018021316	118,90	B4018021312	195,24

Wooden shelf for display cabinet BI525 & BI530

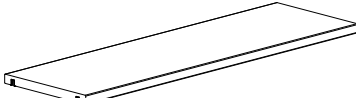
Snapfix incl.	W x D mm	Type of shelf	Item no. Melamine	Price EUR	Item no. Veneer	Price EUR
	500	250	Straight	B4018025206	B4018025202	106,80
	750	250	Straight	B4018027206	B4018027202	113,18
	900	250	Straight	B4018029206	B4018029202	116,38
	1000	250	Straight	B4018021206	B4018021202	161,73

Steel shelf with steel backedge for display cabinet BI525 & BI530

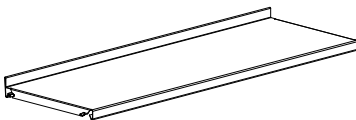
Pins incl. Steel backedge H25 mm. When turned, the shelf can be used as a sloping shelf by using the existing pins and bracket BN066.	W x D mm	Type of shelf	Item no.		Price EUR
			Melamine	Veneer	
	500	250	Straight	B401803521	54,80
	500	300	Sloping	B401803531	62,24
	750	250	Straight	B401803721	58,39
	750	300	Sloping	B401803731	63,57
	900	250	Straight	B401803921	58,79
	900	300	Sloping	B401803931	65,44
	1000	250	Straight	B401803121	59,58
	1000	300	Sloping	B401803131	66,37

Steel shelf for display cabinet BI525 & BI530

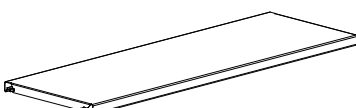
Pins incl.	W x D mm	Type of shelf	Item no.	Price EUR	
	500	250	Straight	B401803520	46,15
	750	250	Straight	B401803720	48,55
	900	250	Straight	B401803920	49,88
	1000	250	Straight	B401803120	50,67

FUNCTIONS

CONFIGURATION NO. 21

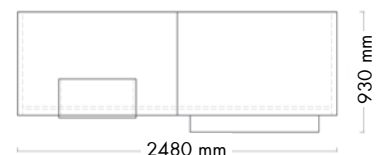

Rectangular counters (with counter top part & bag shelf)

Components	Article no.	Price EUR	Quantity	EUR
Rectangular counter - starter (W1240 x H740 mm)	BI2001022003	797,34	1	797,34
Rectangular counter - end (W1240 x H740 mm)	BI2003022003	797,34	1	797,34
Wooden front panel for rectangular counter (W1200 x H740 mm)	BI300546	314,94	2	629,88
Steel leg frame (H740 mm)	BI069146	379,72	1	379,72
Wooden counter top part with info sign (W600 x H490 mm)	BI820186	343,67	1	343,67
Wooden bag shelf for rectangular counter (W1200 mm)	BI81053	204,16	1	204,16
Total price for configuration				3.152,11

Comments to configuration

- Office chair and text are not included in price.
- All prices are based on colours and surfaces in price group A, see pages 4-7 for colours.
- We recommend the use of desk grommets, cable rails and drawer pedestals with the Inform counter, see page 113.
- The bag shelf is in fact 1000 mm long, adapted to a 1200 mm front panel.

FUNCTIONS

BAG SHELVES

Add functions to your counter. Below you will find products that can be built on to the Inform counter to make it more functional and user friendly. The wooden bag shelves below can only be used with wooden front panels, it is not possible to use with acrylic front panels. The distance from floor to top of shelf is 55 cm.

Wooden bag shelf for rectangular counter

Only use with wooden front panels. Do not use with acrylic front panels. Max. load 5 kg. Actual width of shelf is 200 mm shorter than the width of the counter.

Counter W x	Shelf W x	Shelf D
mm		
600	400	180
800	600	180
1000	800	180
1200	1000	180
1400	1200	180
1600	1400	180

Item no.
HPL

Price
EUR

BI81013	168,11
BI81033	180,22
BI81043	191,92
BI81053	204,16
BI81063	216,13
BI81073	227,96



Wooden bag shelf for 45° curved counter

Only use with wooden front panels. Do not use with acrylic front panels. Max. load 5 kg.

W x D mm
1710 180

Item no.
HPL

Price
EUR

BI815453	540,38
----------	--------

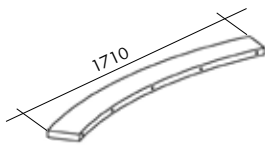

Wooden bag shelf for 90° curved counter

Only use with wooden front panels. Do not use with acrylic front panels. Max. load 5 kg.

W x D mm
1875 180

Item no.
HPL

Price
EUR

BI815903	564,19
----------	--------

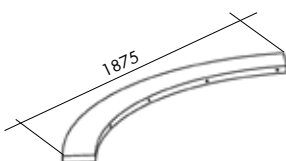

FUNCTIONS

CONFIGURATION NO. 22

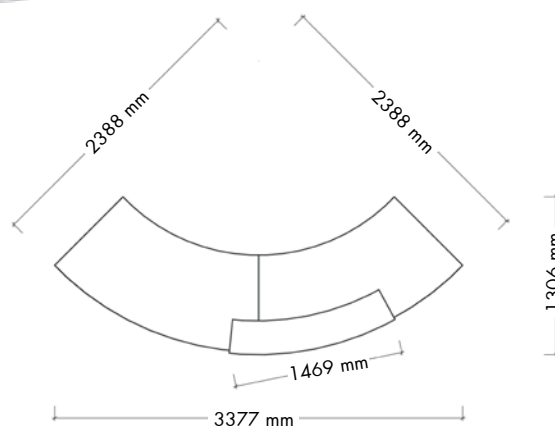

45° curved counters (with counter top part)

Components	Article no.	Price EUR	Quantity	EUR
45° curved counter - starter (H740 mm)	BI2051428003	1.229,32	1	1.229,32
45° curved counter - end (H740 mm)	BI2053428003	1.229,32	1	1.229,32
Wooden front panel for 45° curved counter (H740 mm)	BI3204543	2.104,06	2	4.208,12
Steel leg frame (H740 mm)	BI069146	379,72	1	379,72
Wooden counter top part with info sign (1400 x H490 mm)	BI82545683	1.494,92	1	1.494,92
Total price for configuration				8.541,40

Comments to configuration

- Computer, office chair and text are not included in price.
- All prices are based on colours and surfaces in price group A, see pages 4-7 for colours.
- We recommend the use of desk grommets, cable rails and drawer pedestals with the Inform counter, see page 113.

FUNCTIONS

CONFIGURATION NO. 23

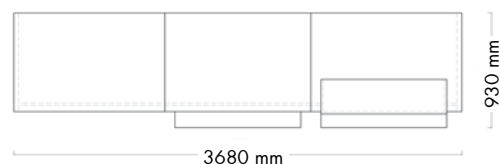

Rectangular counters (with acrylic front panel, bag shelf & counter top part with bag shelf)

Components	Article no.	Price EUR	Quantity	EUR
Rectangular counter - starter (W1240 x H740 mm)	BI2001022003	797,34	1	797,34
Rectangular counter - middle (W1200 x H740 mm)	BI2002082003	497,42	1	497,42
Wooden front panel for rectangular counter (W1200 x H740 mm)	BI300546	314,94	2	629,88
Rectangular counter - end (W1240 x H740 mm)	BI2003022003	797,34	1	797,34
Acrylic front panel for rectangular counter (W1200 x H740 mm)	BI310546	933,13	1	933,13
Steel leg frame (H740 mm)	BI069146	379,72	2	759,44
Wooden counter top part with bag shelf (W1000 x H490 mm)	BI830486	564,72	1	564,72
Wooden bag shelf (W1200 mm)	BI81053	204,16	1	204,16
Stainless steel desk grommet	B4015553	68,76	1	68,76
Total price for configuration				5.252,19

Comments to configuration

- Monitor, key board, office chair and text are not included in price.
- All prices are based on colours and surfaces in price group A, see pages 4-7 for colours.
- We recommend the use of desk grommets, cable rails and drawer pedestals with the Inform counter, see page 113.
- The counter top part and bag shelf are in fact 1000 mm long, adapted to a 1200 mm front panel.

FUNCTIONS

COUNTER TOP PARTS WITH INFO SIGN

Add functions to your counter. Below you will find products that can be built on to the Inform counter to make it more functional and user friendly.

Wooden counter top part with info sign for rectangular counter

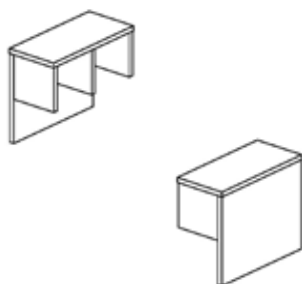

W x H x D mm (OD)	H x D mm (ID)	Item no. Melamine	Price EUR
600 490 280	235 250	BI820186	343,67
800 490 280	235 250	BI820386	367,61
1000 490 280	235 250	BI820486	475,61
1200 490 280	235 250	BI820586	523,22
1400 490 280	235 250	BI820686	571,50
1600 490 280	235 250	BI820786	619,78
600 580 280	325 250	BI820196	343,67
800 580 280	325 250	BI820396	367,61
1000 580 280	325 250	BI820496	475,61
1200 580 280	325 250	BI820596	523,22
1400 580 280	325 250	BI820696	571,50
1600 580 280	325 250	BI820796	619,78

Wooden counter top part with info sign for 45° curved counter

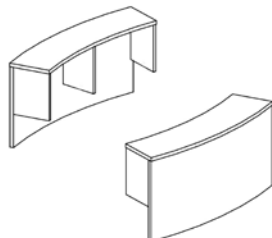

W x H x D mm (OD)	H x D mm (ID)	Item no. HPL	Price EUR
800 490 280	235 250	BI82545383	967,71
1000 490 280	235 250	BI82545483	1.260,04
1200 490 280	235 250	BI82545583	1.414,59
1400 490 280	235 250	BI82545683	1.494,92
800 580 280	325 250	BI82545393	1.130,90
1000 580 280	325 250	BI82545493	1.361,79
1200 580 280	325 250	BI82545593	1.508,62
1400 580 280	325 250	BI82545693	1.610,63

Wooden counter top part with info sign for 90° curved counter

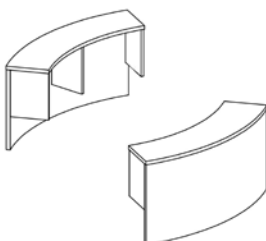

W x H x D mm (OD)	H x D mm (ID)	Item no. HPL	Price EUR
800 490 280	235 250	BI82590383	1.025,30
1000 490 280	235 250	BI82590483	1.327,34
1200 490 280	235 250	BI82590583	1.468,45
1400 490 280	235 250	BI82590683	1.547,59
800 580 280	325 250	BI82590393	1.187,29
1000 580 280	325 250	BI82590493	1.418,05
1200 580 280	325 250	BI82590593	1.564,35
1400 580 280	325 250	BI82590693	1.667,29

FUNCTIONS

COUNTER TOP PARTS WITH INFO SIGN

Add functions to your counter. Below you will find products that can be built on to the Inform counter to make it more functional and user friendly.

Wooden counter top part with info sign for rectangular counter

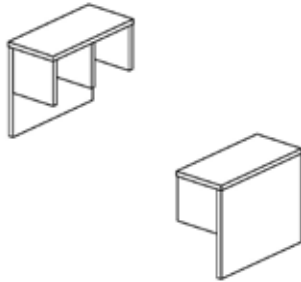

W x H x D mm (OD)	H x D mm (ID)	Item no. Veneer	Price EUR
600 490 280	235 250	BI820182	566,05
800 490 280	235 250	BI820382	605,68
1000 490 280	235 250	BI820482	783,50
1200 490 280	235 250	BI820582	861,84
1400 490 280	235 250	BI820682	941,37
1600 490 280	235 250	BI820782	1.020,91
600 580 280	325 250	BI820192	566,05
800 580 280	325 250	BI820392	605,68
1000 580 280	325 250	BI820492	783,50
1200 580 280	325 250	BI820592	861,84
1400 580 280	325 250	BI820692	941,37
1600 580 280	325 250	BI820792	1.020,91

Wooden counter top part with info sign for 45° curved counter

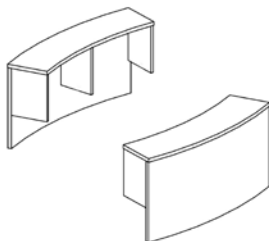

W x H x D mm (OD)	H x D mm (ID)	Item no. Veneer	Price EUR
800 490 280	235 250	BI82545382	1.107,23
1000 490 280	235 250	BI82545482	1.441,45
1200 490 280	235 250	BI82545582	1.618,48
1400 490 280	235 250	BI82545682	1.710,51
800 580 280	325 250	BI82545392	1.293,82
1000 580 280	325 250	BI82545492	1.557,96
1200 580 280	325 250	BI82545592	1.726,07
1400 580 280	325 250	BI82545692	1.842,85

Wooden counter top part with info sign for 90° curved counter

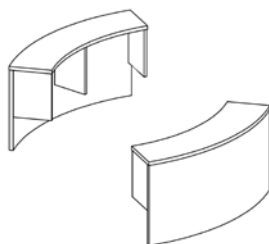

W x H x D mm (OD)	H x D mm (ID)	Item no. Veneer	Price EUR
800 490 280	235 250	BI82590382	1.172,93
1000 490 280	235 250	BI82590482	1.518,73
1200 490 280	235 250	BI82590582	1.679,92
1400 490 280	235 250	BI82590682	1.770,76
800 580 280	325 250	BI82590392	1.358,20
1000 580 280	325 250	BI82590492	1.622,33
1200 580 280	325 250	BI82590592	1.789,52
1400 580 280	325 250	BI82590692	1.907,49

FUNCTIONS

COUNTER TOP PARTS WITH BAG SHELF

Add functions to your counter. Below you will find products that can be built on to the Inform counter to make it more functional and user friendly. The counter top parts can only be used with wooden front panels, it is not possible to use with acrylic front panels.

Wooden counter top part with bag shelf for rectangular counter

Max. load 5 kg.

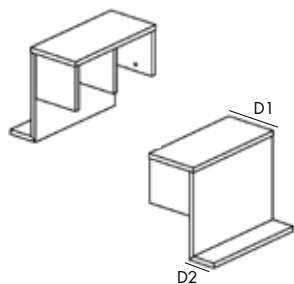

W x H x D1 x D2 mm (OD)	H x D mm (ID)	Item no. Melamine	Price EUR
600 490 280 130	235 250	BI830186	516,84
800 490 280 130	235 250	BI830386	537,19
1000 490 280 130	235 250	BI830486	564,72
1200 490 280 130	235 250	BI830586	598,50
1400 490 280 130	235 250	BI830686	636,94
1600 490 280 130	235 250	BI830786	732,17
600 580 280 130	325 250	BI830196	516,84
800 580 280 130	325 250	BI830396	537,19
1000 580 280 130	325 250	BI830496	564,72
1200 580 280 130	325 250	BI830596	598,50
1400 580 280 130	325 250	BI830696	636,94
1600 580 280 130	325 250	BI830796	732,17

Wooden counter top part with bag shelf for 45° curved counter

Max. load 5 kg.

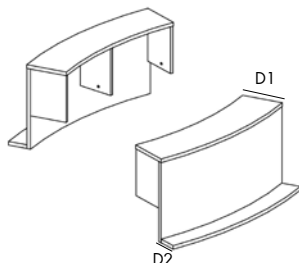

W x H x D1 x D2 mm (OD)	H x D mm (ID)	Item no. HPL	Price EUR
800 490 280 130	235 250	BI83545383	1.560,36
1000 490 280 130	235 250	BI83545483	1.599,72
1200 490 280 130	235 250	BI83545583	1.638,83
1400 490 280 130	235 250	BI83545683	1.758,93
800 580 280 130	325 250	BI83545393	1.666,36
1000 580 280 130	325 250	BI83545493	1.705,99
1200 580 280 130	325 250	BI83545593	1.745,89
1400 580 280 130	325 250	BI83545693	1.829,95

Wooden counter top part with bag shelf for 90° curved counter

Max. load 5 kg.

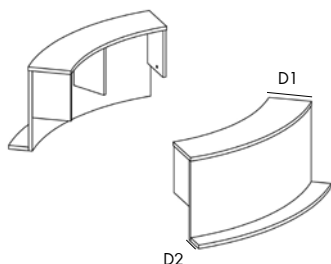

W x H x D1 x D2 mm (OD)	H x D mm (ID)	Item no. HPL	Price EUR
800 490 280 130	235 250	BI83590383	1.723,41
1000 490 280 130	235 250	BI83590483	1.762,92
1200 490 280 130	235 250	BI83590583	1.802,42
1400 490 280 130	235 250	BI83590683	1.842,05
800 580 280 130	325 250	BI83590493	1.819,17
1000 580 280 130	325 250	BI83590593	1.858,81
1200 580 280 130	325 250	BI83590693	1.901,77
1400 580 280 130	325 250	BI83590393	1.779,67

FUNCTIONS

COUNTER TOP PARTS WITH BAG SHELF

Add functions to your counter. Below you will find products that can be built on to the Inform counter to make it more functional and user friendly. The counter top parts can only be used with wooden front panels, it is not possible to use with acrylic front panels.

Wooden counter top part with bag shelf for rectangular counter

Max. load 5 kg.

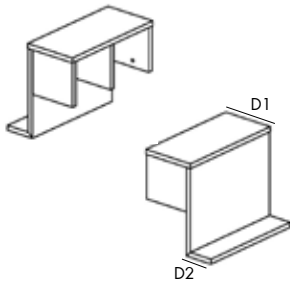

W x H x D1 x D2 mm (OD)	H x D mm (ID)	Item no. Veneer	Price EUR
600 490 280 130	235 250	BI830182	850,80
800 490 280 130	235 250	BI830382	884,85
1000 490 280 130	235 250	BI830482	929,80
1200 490 280 130	235 250	BI830582	985,93
1400 490 280 130	235 250	BI830682	1.048,97
1600 490 280 130	235 250	BI830782	1.206,18
600 580 280 130	325 250	BI830192	850,80
800 580 280 130	325 250	BI830392	884,85
1000 580 280 130	325 250	BI830492	929,80
1200 580 280 130	325 250	BI830592	985,93
1400 580 280 130	325 250	BI830692	1.048,97
1600 580 280 130	325 250	BI830792	1.206,18

Wooden counter top part with bag shelf for 45° curved counter

Max. load 5 kg.

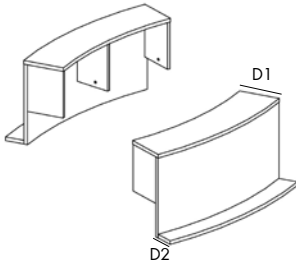

W x H x D1 x D2 mm (OD)	H x D mm (ID)	Item no. Veneer	Price EUR
800 490 280 130	235 250	BI83545382	1.784,86
1000 490 280 130	235 250	BI83545482	1.830,35
1200 490 280 130	235 250	BI83545582	1.874,77
1400 490 280 130	235 250	BI83545682	2.005,11
800 580 280 130	325 250	BI83545392	1.906,42
1000 580 280 130	325 250	BI83545492	1.951,51
1200 580 280 130	325 250	BI83545592	1.984,89
1400 580 280 130	325 250	BI83545692	2.086,11

Wooden counter top part with bag shelf for 90° curved counter

Max. load 5 kg.

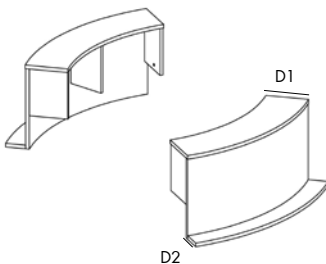

W x H x D1 x D2 mm (OD)	H x D mm (ID)	Item no. Veneer	Price EUR
800 490 280 130	235 250	BI83590382	1.971,86
1000 490 280 130	235 250	BI83590482	2.016,95
1200 490 280 130	235 250	BI83590582	2.062,03
1400 490 280 130	235 250	BI83590682	2.107,39
800 580 280 130	325 250	BI83590392	2.036,10
1000 580 280 130	325 250	BI83590492	2.081,32
1200 580 280 130	325 250	BI83590592	2.126,54
1400 580 280 130	325 250	BI83590692	2.175,75

FUNCTIONS

CONFIGURATION NO. 24

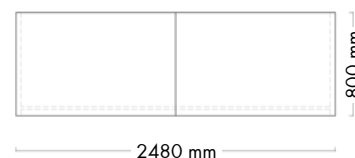

Rectangular counters (with decorative boards)

Components	Article no.	Price EUR	Quantity	EUR
Rectangular counter - starter (W1240 x H740 mm)	BI2001022003	797,34	1	797,34
Rectangular counter - end (W1240 x H740 mm)	BI2003022003	797,34	1	797,34
Wooden front panel for rectangular counter (W1200 x H740 mm)	BI300546	314,94	2	629,88
Steel leg frame (H740 mm)	BI069146	379,72	1	379,72
Wooden decorative board - high (W600 x H740 mm)	BI840146	71,82	1	71,82
Wooden decorative board - narrow (W600 x H190 mm)	BI845116	45,09	1	45,09
Total price for configuration				2.721,19

Comments to configuration

- Office chair and text are not included in price.
- All prices are based on colours and surfaces in price group A, see pages 4-7 for colours.
- We recommend the use of desk grommets, cable rails and drawer pedestals with the Inform counter, see page 113.

FUNCTIONS

DECORATIVE BOARDS AND INFO SIGNS

Wooden decorative board - high

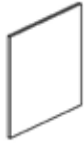

W	x	H	x	D	Item no. Melamine	Price EUR	Item no. Veneer	Price EUR
600		740		19	BI840146	71,82	BI840142	118,10
600		1000		19	BI840166	84,32	BI840162	138,72

Wooden decorative board - narrow



W	x	H	x	D	Item no. Melamine	Price EUR	Item no. Veneer	Price EUR
600		190		19	BI845116	45,09	BI845112	74,48
800		190		19	BI845316	49,08	BI845312	80,86
1000		190		19	BI845416	52,80	BI845412	86,85
1200		190		19	BI845516	55,86	BI845512	92,04
1400		190		19	BI845616	61,05	BI845612	100,55
1600		190		19	BI845716	64,77	BI845712	106,80

Wooden info sign

Melamine/veneer board. Only use with wooden front panels. Do not use with acrylic front panels.

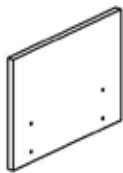

W	x	H	x	D	Item no. Melamine	Price EUR	Item no. Veneer	Price EUR
600		430		25	BI850126	170,77	BI850122	281,30
800		430		25	BI850326	189,79	BI850322	312,28
1000		430		25	BI850426	219,45	BI850422	361,76
1200		430		25	BI850526	237,94	BI850522	391,42

Acrylic info sign (se configuration no 25.)

Acrylic frosted white glazed board. Only use with wooden front panels. Do not use with acrylic front panels.

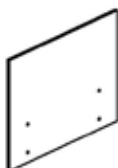

W	x	H	x	D	Item no. Acrylic	Price EUR
600		430		10	BI85512	336,89
800		430		10	BI85532	348,33
1000		430		10	BI85542	365,22
1200		430		10	BI85552	388,23

FUNCTIONS

CONFIGURATION NO. 25

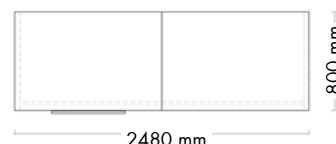

Rectangular counters (with acrylic info sign, desk grommet and monitor arm)

Components	Article no.	Price EUR	Quantity	EUR
Rectangular counter - starter (W1240 x H740 mm)	BI2001022003	797,34	1	797,34
Rectangular counter - end (W1240 x H740 mm)	BI2003022003	797,34	1	797,34
Wooden front panel for rectangular counter (W1200 x H740 mm)	BI300546	314,94	1	314,94
Acrylic front panel for rectangular counter (W1200 x H740 mm)	BI310546	933,13	1	933,13
Steel leg frame (H740 mm)	BI069146	379,72	1	379,72
Info sign - acrylic frosted white glazed (W600 x H430 mm)	BI85512	336,89	1	336,89
Monitor arm	B401184	845,08	1	845,08
Total price for configuration				4.404,44

Comments to configuration

- Monitor, office chair and text are not included in price.
- All prices are based on colours and surfaces in price group A, see pages 4-7 for colours.
- We recommend the use of desk grommets, cable rails and drawer pedestals with the Inform counter, see page 113.
- It is necessary to drill an Ø80 mm hole for the monitor arm on site or modify the article number for counter for predrilled hole, see pages 120-121.

FUNCTIONS

FUNCTIONAL ACCESSORIES

Desk grommet

Ø80 mm. Drill hole is not included. For placement of drill hole, see cable conduct on pages 122-123.



Material	Colour	Item no.	Price EUR
Plastic	Oyster white	B4015548	21,01
Plastic	Black	B4015542	21,01
Plastic	Silver	B4015549	21,01
Metal	Stainless steel	B4015553	68,76

Monitor arm

Silver. For placement of drill hole, see cable conduct on pages 120-121. Drill holes for monitor arm will most often be drilled on site.

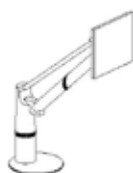

Item no.	Price EUR
B401184	845,08

CPU holder

W230 x H551 x D500 mm. Laquered steel. Practical storage of CPU holder under counter. Does not fit with recessed counter.

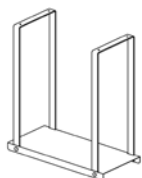

Item no.	Price EUR
B401180	213,60

Cable channel

W495 x H70 x D115 mm. Laquered steel. Is bendable - can be used with both straight and curved counters. For required quantities, see below.

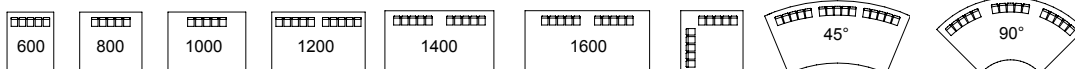

Item no.	Price EUR
B401182A28	49,38

Drawer pedestal

W442 x H615 x D585 mm. With office supplies drawer and 2/3 drawers.

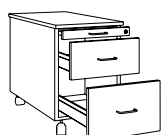

Drawers	Item no. Melamine	Price EUR	Item no. Veneer	Price EUR
1 drawer (128 mm)	B401195256	1.672,87	B401195252	2.755,36
1 drawer (320 mm)				
1 drawer (192 mm)	B401195346	1.554,77	B401195342	2.560,92
1 drawer (256 mm)				
2 drawers (128 mm)	B401195236	1.834,60	B401195232	3.022,29
1 drawer (192 mm)				

FUNCTIONS

POWER SOCKETS

Power socket Square 80

W181 x D96 mm with lid open.
With sliding lid.
Mounting hole Ø80 mm.
Worktop thickness 10-50 mm.
3 m cable length.

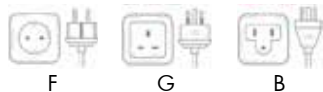

Colour	USB	Type	Market	Item no.	Price EUR
Black	1	1 x F	BE/DE/DK/FR/SE	B4015002101	241,40
White	1	1 x F	BE/DE/DK/FR/SE	B4015001101	241,40
Black	1	1 x G	GB	B4015002311	241,40
White	1	1 x G	GB	B4015001311	241,40
Black	1	1 x B	US	B4015002221	241,40

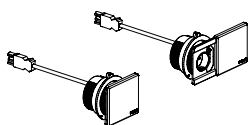

Built-in power socket BackFlip

W225 x D105 mm.
Lid flips 180 deg.
Mounting depth 53 mm.
Worktop thickness 10-40 mm.
2,5 m cable length.

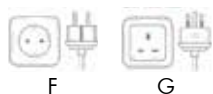

Colour	USB	Type	Market	Item no.	Price EUR
Stainless steel	2	2 x F	BE/DE/DK/FR/SE	B4015013102	432,52
Stainless steel	2	2 x G	GB	B4015013312	432,52

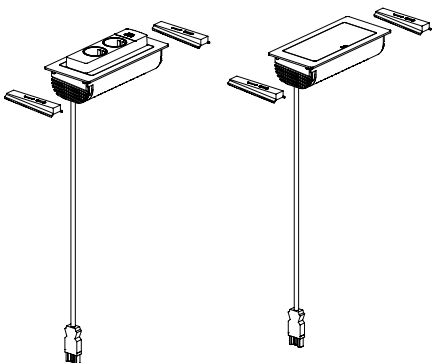

FUNCTIONS

POWER SOCKETS

Built-in power socket FlipTop Push

W260 x D167 mm.
Open lid with soft touch.
Mounting depth 68 mm.
Worktop thickness 10-50 mm.
3 m cable length.

Colour	USB	Type	Market	Item no.	Price EUR
Stainless steel	2	3 x F	BE/DE/DK/FR/SE	B4015023103	692,93
Stainless steel	2	2 x G	GB	B4015023312	692,93

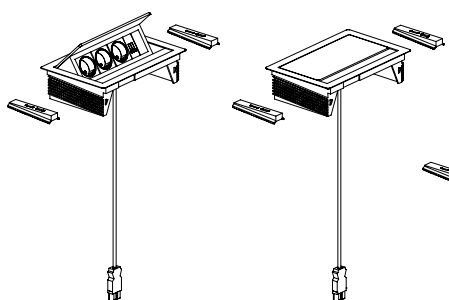
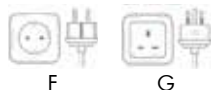

Built-in power socket FrameDock

W260 x D167 mm.
Mounting depth 51 mm.
Worktop thickness 5-38 mm.
3 m cable length.

Colour	USB	Type	Market	Item no.	Price EUR
Black	2	3 x F	BE/DE/DK/FR/SE	B4015032103	431,19
White	2	3 x F	BE/DE/DK/FR/SE	B4015031103	431,19
Black	2	2 x G	GB	B4015032312	431,19
Black	2	2 x B	US	B4015032222	431,19

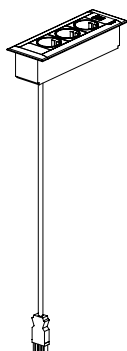

FRONT PANEL OPTIONS

CONFIGURATION NO. 26

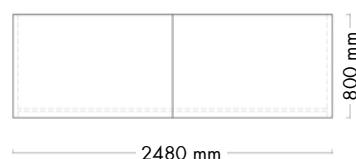

Rectangular counters (with acrylic front panels and lighting)

Components	Article no.	Price EUR	Quantity	EUR
Rectangular counter - starter (W1240 x H740 mm)	BI2001022003	797,34	1	797,34
Rectangular counter - end (W1240 x H740 mm)	BI2003022003	797,34	1	797,34
Acrylic front panel for rectangular counter (W1200 x H740 mm)	BI310546	933,13	2	1.866,26
Light for acrylic front panel (W1200 mm)	BI86051	295,79	2	591,58
Steel leg frame (H740 mm)	BI069146	379,72	1	379,72
Monitor arm	B401184	845,08	1	845,08
Total price for configuration				5.277,32

Comments to configuration

- Monitor and office chair are not included in price.
- All prices are based on colours and surfaces in price group A, see pages 4-7 for colours.
- We recommend the use of desk grommets, cable rails and drawer pedestals with the Inform counter, see page 113.
- It is necessary to drill an Ø80 mm hole for the monitor arm on site or modify the article number for counter for predrilled hole, see pages 120-121.
- Above article number for light is for German voltage and plug. Contact Sales for further information on voltage and plug for other countries.

FRONT PANEL OPTIONS

LED LIGHT

Create your own individual counter! You can differentiate your counter by use of acrylic front panels with light. See Design Options for acrylic front panel options. Note - the LED lighting can only be used for Standard Inform rectangular and curved counters.

Light for rectangular counter with acrylic front panel

Light mounted underneath table top on the inside of the counter. With cable and plug for the European market (except UK). Contact sales for plug and voltage for other countries.	W counter	W lamp	Watt	Item no.	Price EUR
	800	595	1 x 14W	BI86031	272,52
	1000	895	1 x 21W	BI86041	295,79
	1200	895	1 x 21W	BI86051	295,79
	1400	1195	1 x 28W	BI86061	343,41
	1600	1495	1 x 35W	BI86071	361,10

Light for 45° and 90° curved counter with acrylic front panel

Light mounted underneath table top on the inside of the counter. With cable and plug for the European market (except UK). Contact sales for plug and voltage for other countries.	Deg.	W lamp	Watt	Item no.	Price EUR
	45°	595	2 x 14W	BI862451	536,52
	90°	595	2 x 14W	BI862901	536,52

FRONT PANEL OPTIONS

CONFIGURATON NO. 27

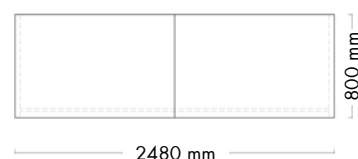

Rectangular counters (with graphics on wooden front panel)

Components	Article no.	Price EUR	Quantity	EUR
Rectangular counter - starter (W1240 x H740 mm)	BI2001022003	797,34	1	797,34
Rectangular counter - end (W1240 x H740 mm)	BI2003022003	797,34	1	797,34
Wooden front panel for rectangular counter (W1200 x H740 mm)	BI300546	314,94	2	629,88
Additional graphics to wooden front panel (W1200 x H740 mm)	BI86454	373,60	2	747,20
Steel leg frame (H740 mm)	BI069146	379,72	1	379,72
Monitor arm	B401184	845,08	1	845,08
Total price for configuration				4.196,56

Comments to configuration

- Monitor, key board and office chair are not included in price.
- All prices are based on colours and surfaces in price group A, see pages 4-7 for colours.
- We recommend the use of desk grommets, cable rails and drawer pedestals with the Inform counter, see page 113.
- It is necessary to drill an Ø80 mm hole for the monitor arm on site or modify the article number for counter for predrilled hole, see pages 120-121.

FRONT PANEL OPTIONS

GRAPHICS

Create your own individual counter! Use the front of the counter as a display for your ideas. The Inform counter gives you the opportunity to design all wooden front panels in accordance with your wishes and requirements. Use pictures, graphics or text to make a statement!

Front image for rectangular front panel

Price for full size sticker. Smaller stickers and logos on request. Price excl. front panel.	H mm	W mm	Item no.	Price EUR
	740	600	BI86414	279,97
	740	800	BI86434	303,11
	740	1000	BI86444	326,78
	740	1200	BI86454	373,60
	740	1400	BI86464	396,87
	740	1600	BI86474	435,71
	1000	600	BI86416	326,78
	1000	800	BI86436	350,19
	1000	1000	BI86446	373,60
	1000	1200	BI86456	420,01
	1000	1400	BI86466	443,42
	1000	1600	BI86476	487,18

Front image for 45° curved front panel

Price for full size sticker. Smaller stickers and logos on request. Price excl. front panel.	H mm	W mm	Item no.	Price EUR
	740	1830	BI866454	420,01
	1000	1850	BI866456	466,70

Front image for 90° curved front panel

Price for full size sticker. Smaller stickers and logos on request. Price excl. front panel.	H mm	W mm	Item no.	Price EUR
	740	1830	BI866904	420,01
	1000	1850	BI866906	466,70

Front image for corner front panel

Price for full size sticker. Smaller stickers and logos on request. Price excl. front panel.	H mm	W mm	Item no.	Price EUR
	740	800	BI8684	747,19
	1000	800	BI8686	839,76

Text for front panel

Item no.	Price EUR
B400003	

DRILL HOLES

FOR CABLE CONDUCT

It is possible to have counters delivered with predrilled holes and desk grommets for cable conduct. There is a surcharge per drill hole and desk grommet. Please inform Customer Service where you would like the predrilled hole to be placed (0-7) and which desk grommet (0/2/3/8/9) you would like. Remember to view the counter from left to right, as if sitting behind the counter.

Drill hole for desk grommet for rectangular, step and height adjustable counters

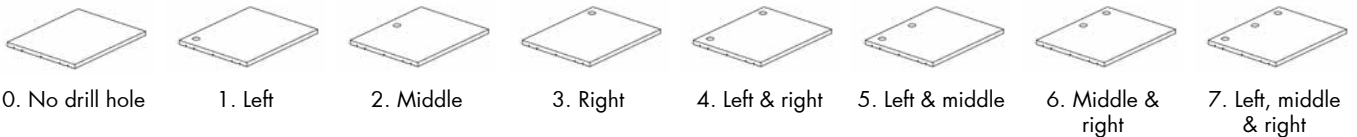

Drill hole for desk grommet for recessed rectangular counters

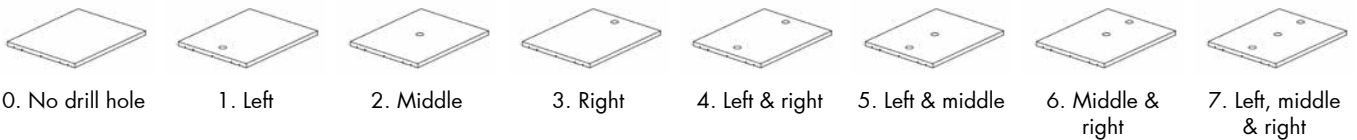

Drill hole for desk grommet for 45° and 90° curved counters

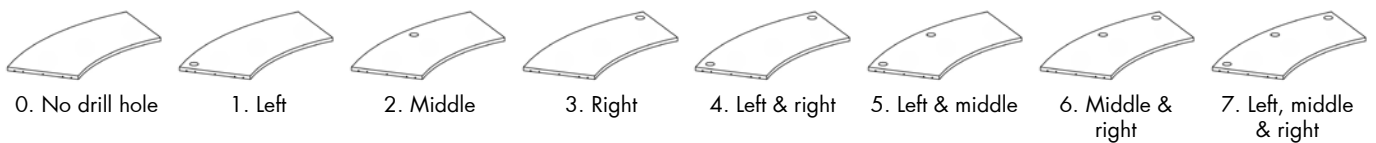

Drill hole for desk grommet for 45° and 90° recessed curved counters

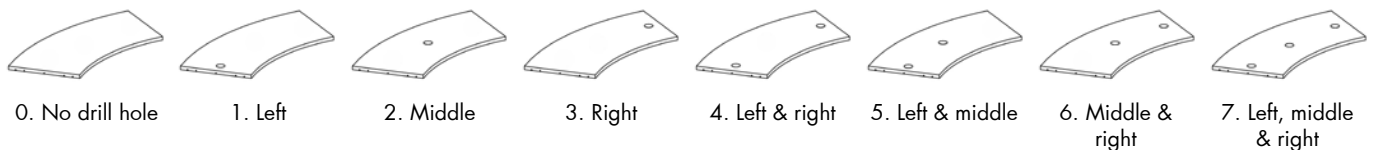

DRILL HOLES

FOR CABLE CONDUCT

It is possible to have counters delivered with predrilled holes and desk grommets for cable conduct. There is a surcharge per drill hole and desk grommet. Please inform Customer Service where you would like the predrilled hole to be placed (0-7) and which desk grommet (0/2/3/8/9) you would like. Remember to view the counter from left to right, as if sitting behind the counter.

Drill hole for desk grommet for corner counter - side A

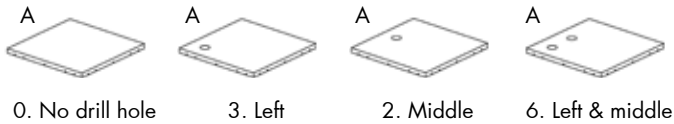

Drill hole for desk grommet for corner counter - side B

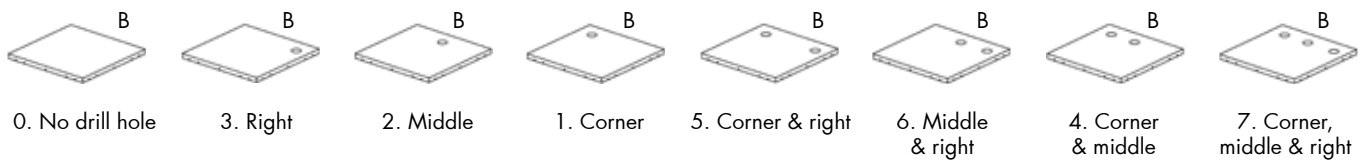

Drill hole for desk grommet for triangular corner counter

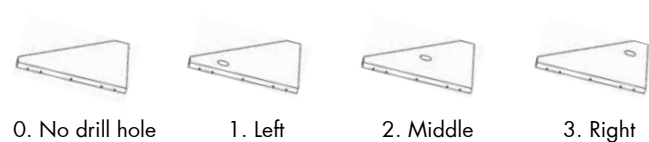

Desk grommet

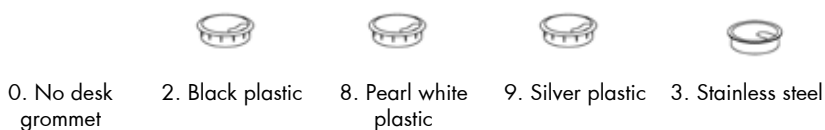

RFID INSTALLATION

PREPARATION FOR INSTALLATION OF RFID IN COUNTERTOP

The Inform counter offers the option to install an RFID PCB under the countertop, whether straight, curved or height adjustable. The 40 mm thick countertop is recessed below the central section to allow for the optimal positioning of the RFID PCB as needed. As far as the dimension of the countertop is concerned, the central recessed section leaves a peripheral circumference of 80 mm to 110 mm to preserve the visual aesthetics of the 40 mm top. In the recessed section, the countertop is 20 mm thick, thus complying with the technical specifications of most RFID systems for counters.

RFID installation in rectangular counter

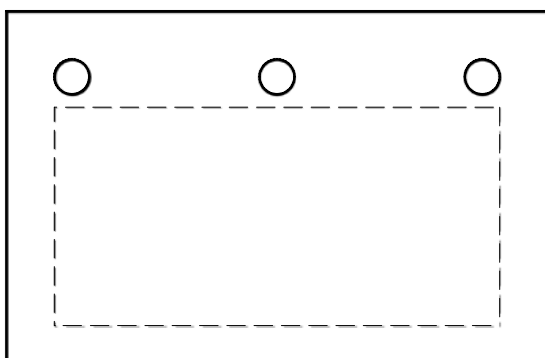

RFID installation in recessed rectangular counter

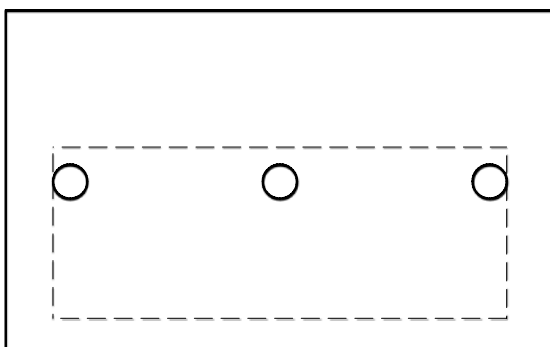

RFID INSTALLATION

PREPARATION FOR INSTALLATION OF RFID IN COUNTERTOP

The Inform counter offers the option to install an RFID PCB under the countertop, whether straight, curved or height adjustable. The 40 mm thick countertop is recessed below the central section to allow for the optimal positioning of the RFID PCB as needed. As far as the dimension of the countertop is concerned, the central recessed section leaves a peripheral circumference of 80 mm to 110 mm to preserve the visual aesthetics of the 40 mm top. In the recessed section, the countertop is 20 mm thick, thus complying with the technical specifications of most RFID systems for counters.

RFID installation in 45° curved counters

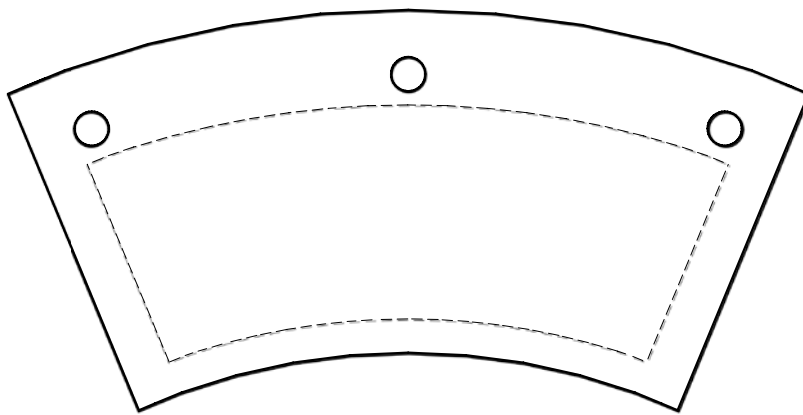

RFID installation in 90° curved counters

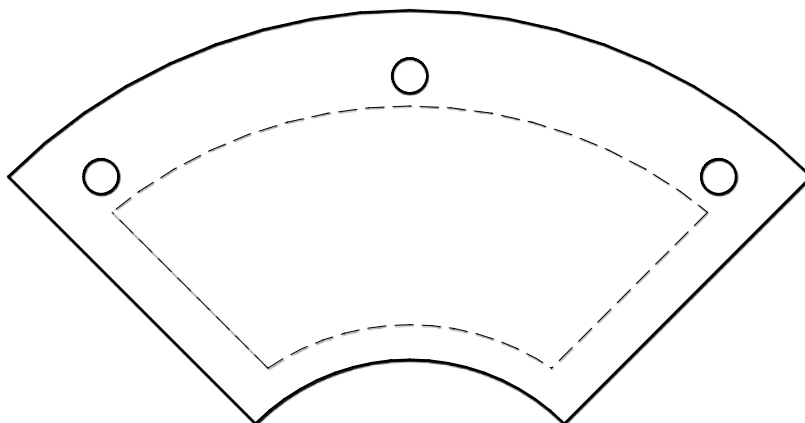

LOCATIONS

WE ARE LIBRARY PEOPLE®



DENMARK

Lammhults Biblioteksdesign A/S
Dalbækvej 1
6670 Holsted

bci@bci.dk
www.bci.dk

FRANCE

BC Intérieur Sarl
6 allée Kepler
77420 Champs sur Marne

bci@bcinterieur.com
www.bcinterieur.com

BELGIUM

SBNL - Schulz Benelux BVBA
Appelweg 94 C
3221 Holsbeek

info@sbnl.be
www.sbnl.be

SWEDEN

Lammhults Biblioteksdesign AB
Odlarevägen 16
226 60 Lund

eurobib@eurobib.se
www.eurobib.se

GERMANY

Schulz Speyer Bibliothekstechnik AG
Hafenstraße 2
67346 Speyer

sales@schulzspeyer.de
www.schulzspeyer.de

UNITED KINGDOM

thedesignconcept Ltd.
The Old Bakery,
10 Greenless Road
Cambuslang Belgrave Street
Glasgow G72 8JJ

info@thedesignconcept.co.uk
www.thedesignconcept.co.uk

NORWAY

BS Eurobib AS
Alf Bjerckes Vei 20
0582 Oslo

post@bseurobib.no
www.bseurobib.no