



CONCERTINA

01.01.2022



CONCERTINA COUNTER

Concertina is an adjustable and ergonomic work station. The counter takes the comfort of the user into account and improves the work habit of library and office employees. The height adjustability gives the user the flexibility to change work postures during the course of the day to break potentially health-impairing routines or to adjust the work station to fit several individuals or tasks simultaneously.

The counter is often placed at the entrance area and is the first point of contact, thus the first impression of the library. Therefore, the counter should be welcoming, inviting and tempt people to enter and explore the library.

With its aesthetic and functional design the Concertina counter offers a flexible system with a range of options to fit the individual needs.



DESIGN OPTIONS..... 4
TECHNICAL SPECIFICATIONS..... 6

CONFIGURATIONS

CONCERTINA COUNTER..... 9
Configuration 11

COMPONENTS

BASE MODULES
Straight base module - steel front panel 12
Curved base module - steel front panel 13

INTERMEDIATE MODULES
Intermediate module 14

COUNTER TOPS
Counter top for straight base module 15
Counter top for 45° curved base module 16
Counter top for 60° curved base module 17

ACCESSORIES
Accessories 19

DESIGN OPTIONS

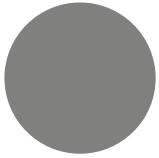

The Concertina counter is delivered as standard in Concertina grey (A29) and all prices in this price list are based on this.

Please see specifications below for the various parts on a Concertina counter:

LOWER FRONT PANEL (1)

The lower front panel is made of steel and delivered as standard in Concertina grey (A29).

UPPER FRONT PANEL (2)

The upper front panel is made of steel and delivered as standard in Concertina grey (A29) and can be ordered in other colours - see page 5.

END FRAMES (3)

The end frames are made of steel and delivered as standard in Concertina grey (A29).

ACTUATOR (4)

The actuator is only available in White Aluminium (A14).

RUBBER EDGING (5) AND BUMPERS (6)

The rubber edging and bumpers are delivered as standard in grey, but are available in black at no surcharge.

STEEL PART ON COUNTER TOPS (7)

The steel parts on the counter tops are delivered as standard in Concertina grey (A29).

COUNTER TOPS (8) AND BAG SHELVES (9)

The counter tops and bag shelves are as standard produced in grey laminate "Dandekor Etronit MB 311 NCS 4502-B Grey" (#185) or grey linoleum "Forbo desktop elegance 4175 Grey" (#257). Some special laminates and linoleums may release a surcharge.

DRAWER PEDESTALS (10)

The drawer pedestals are as standard produced in Concertina grey (A29). The drawer pedestals can be painted in any NCS or RAL colour without extra surcharge.

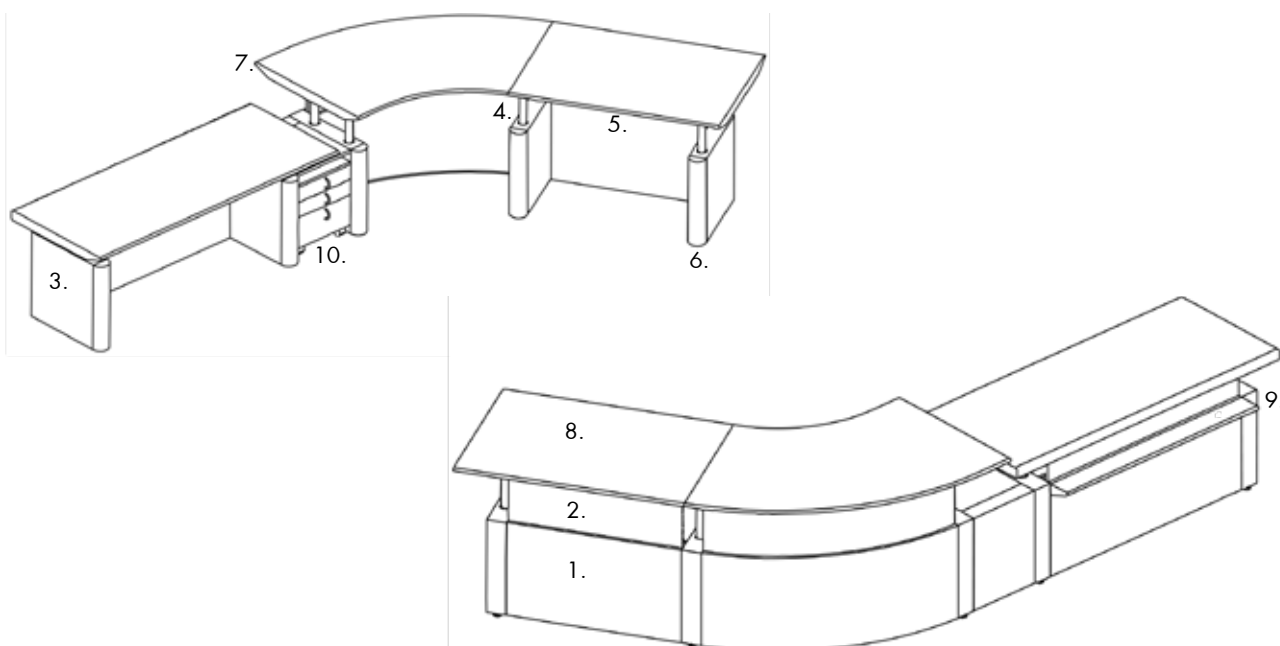

DESIGN OPTIONS

STEEL COMPONENTS - PAINTED

A PRICE GROUP - BASIS PRICE (smooth finish)



A03
Traffic white
RAL 9016
Gloss 75-90



A02
Oyster white
RAL 1013
Gloss 40-50

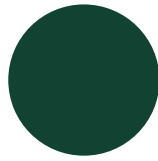

A22
Moss green
RAL 6005
Gloss 71-85



A26
Fir green
RAL 6009
Gloss 71-85

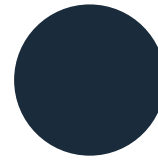

A12
Steel blue
RAL 5011
Gloss 71-85

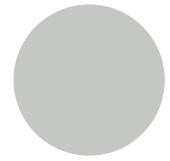

A13
Light grey
RAL 7035
Gloss 71-85

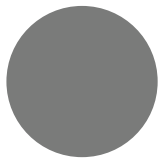

A15
Dusty grey
RAL 7037
Gloss 71-85

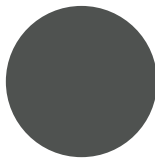

A16
Traffic grey
RAL 7043
Gloss 71-85

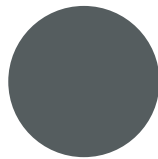

A17
Basalt grey
RAL 7012
Gloss 71-85

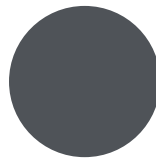

A18
Slate grey
RAL 7015
Gloss 71-85

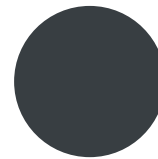

A19
Anthracite grey
RAL 7016
Gloss 71-85

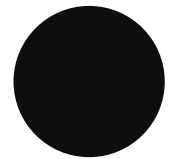

A25
Jet black
RAL 9005
Gloss 71-85

B PRICE GROUP - BASIS PRICE WITH 7% SURCHARGE (smooth finish)



A01
Pure white
RAL 9010
Gloss 71-85

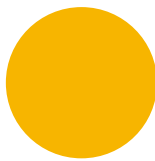

A04
Traffic yellow
RAL 1023
Gloss 71-85

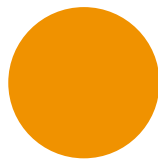

A05
Sun yellow
RAL 1037
Gloss 71-85

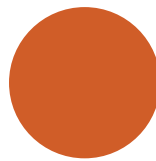

A06
Signal orange
RAL 2010
Gloss 71-85

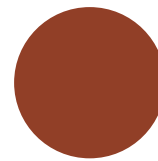

A07
Pearl orange
RAL 2013
Gloss 65-85

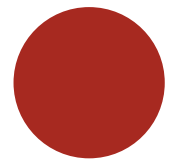

A08
Flame red
RAL 3000
Gloss 71-85

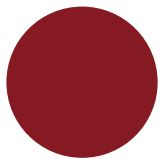

A09
Ruby red
RAL 3003
Gloss 71-85

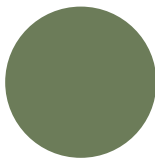

A21
Reseda green
RAL 6011
Gloss 71-85

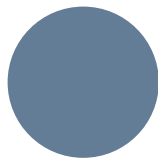

A10
Pigeon blue
RAL 5014
Gloss 71-85

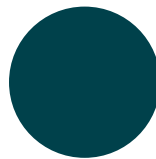

A11
Ocean blue
RAL 5020
Gloss 71-85

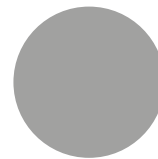

A14
White aluminium
RAL 9006
Gloss 50-70

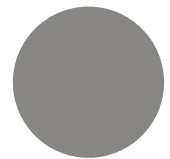

A31
Grey aluminium
RAL 9007
Gloss 50-70

B PRICE GROUP - BASIS PRICE WITH 7% SURCHARGE (textured finish)



A27
Pure white
RAL 9010

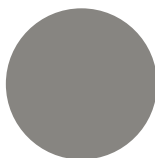

A28
Grey aluminium
RAL 9007

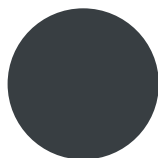

A23
Anthracite grey
RAL 7016

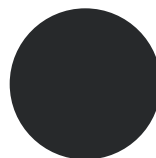

A24
Graphite black
RAL 9011

TECHNICAL SPECIFICATIONS

GENERAL SPECIFICATIONS

CONSTRUCTION

The construction of the Concertina counter with more than one module is based on a left-to-right sequence (seen from the person's view sitting behind the counter).

BASE MODULES

The base module has a lower dual front panel, a cable carrier, an upper front panel and two end frames. The end frames are fitted with a rubberized half round PVC bumper in medium grey placed on the user side and supplied with two actuators.

The base modules are available as:

- Two optional widths (1100 or 1500 mm)
- Straight and curved modules (45° or 60°)
- Fixed height (standard 720 mm) or electronically adjustable (700 - 1200 mm)
- Freestanding or connected modules (starter and add-on)
- Front panel in steel
- Upper front panel in solid steel or perforated steel

UPPER FRONT PANELS

The upper front panel has either a solid steel or steel perforated surface. It is fastened underneath the counter top and follows the counter top up and down.

COUNTER TOPS

The counter tops are supplied with solid, grey, flexible, rubberized PVC edges. The counter tops are available as:

- Three optional depths (660, 780 or 900 mm)
- Four optional functions (freestanding, left side free, middle, right side free)
- Optional widths depending on base module width:
 - 1100 mm base = 1100, 1300 or 1500 mm
 - 1500 mm base = 1500, 1700 or 1900 mm
- Four designs (no projection, projection towards client, projection towards user, projection both sides)

INTERMEDIATE MODULES

The intermediate module includes a dual front panel, cable carrier and a top shelf. It is used to connect modules that do not have connecting counter tops.

ELECTRICAL WIRE TRANSFER

All end frames have a rectangular electrical wire transfer knock out on the right hand side of the end frame (when viewed from the user's side). Configurations of successive modules are prepared for wire-lead through in the end frames. The cable carrier is placed between the dual front panels on the base module, supporting any wire electrical components.

TECHNICAL SPECIFICATIONS

STEEL COMPONENTS

STEEL COMPONENTS

are powder coated with standard polyester based powders that secures high UV resistance. Powders comply with EN 45545 (fire protection - similar to DIN 4201). Thickness of the coating is 60-80 my.

The powder used includes:

- no triglycidylisocyanurate (TGIC)
- no heavy metal-containing pigments such as lead and cadmium
- no volatiles

Antibacterial equipping of surfaces upon request.



Morsø Public Library, Denmark
Two Concertina 45° curved base modules with counter tops

CONCERTINA COUNTER

DIMENSIONS

The modules for a Concertina counter vary in size. Please find important dimensions below.

HEIGHT

The Concertina counter is available in two models - fixed height (standard 720 mm) or adjustable height. Fixed height counters can be ordered in the range from 700-1200 mm.

DEPTH

The straight and curved counter tops are available in three depths:

- 660 mm
- 780 mm
- 900 mm

WIDTH

The straight base modules are available in two widths: 1100 mm, 1500 mm

The straight and curved counter tops are available in four widths, depending on type of module (straight/curved), counter top depth (660/780/900 mm) and curve (45°/60°):

- 1300 mm
- 1500 mm
- 1700 mm
- 1900 mm

See below for further specifications.

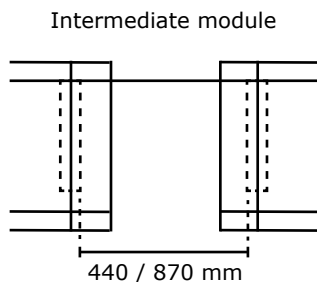
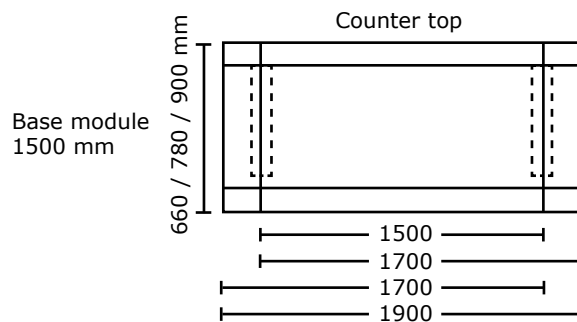
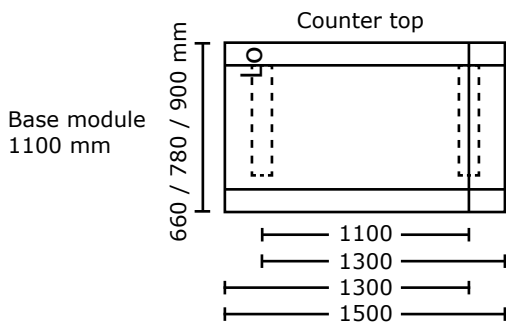

Curved modules

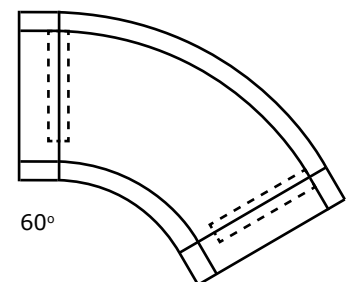
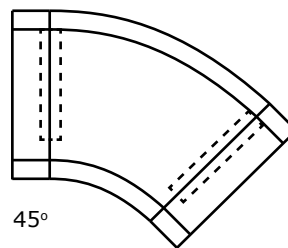

CONFIGURATION OF COUNTER TOPS

Base module	Width mm counter top
1100 mm	1100 mm counter top is used when connecting modules are placed on either side
1100 mm	1300 mm counter top is used when an adjacent module is placed on one side
1100 mm	1500 mm counter top is used for a freestanding module
1500 mm	1500 mm counter top is used when connecting modules are placed on either side
1500 mm	1700 mm counter top is used when an adjacent module is placed on one side
1500 mm	1900 mm counter top is used for a freestanding module



CONCERTINA COUNTER

CONFIGURATION

Below you will find a price example of a Concertina counter:

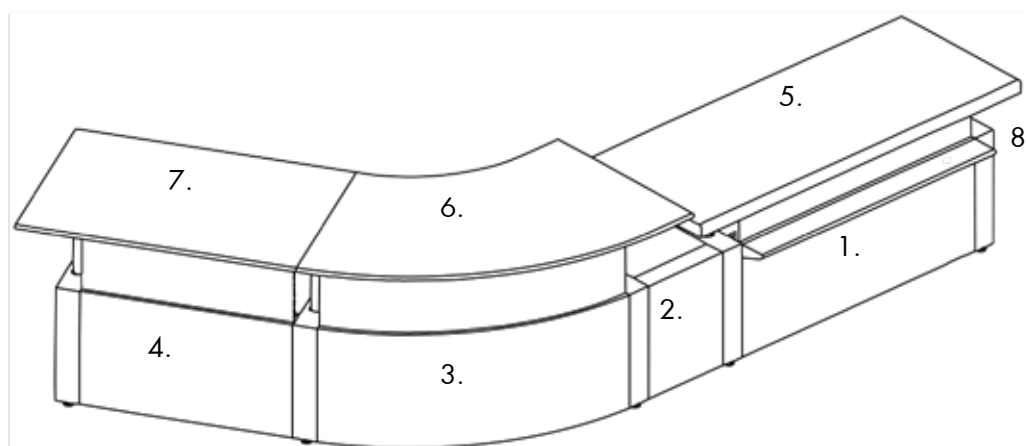
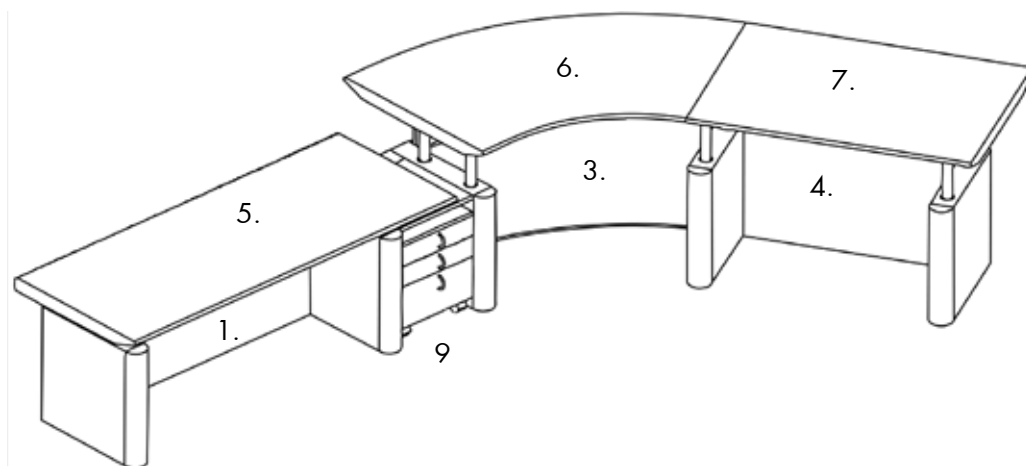

NO.	DESCRIPTION	ITEM NO.
1.	Straight start base module with steel front panel and steel upper panel. W1500 mm. Fixed height 700 mm.	B36000107015340
2.	Intermediate module. W440 mm.	B360009703
3.	60° curved base module with steel front panel and steel upper panel. Electronically adjustable height.	B36000100060340
4.	Straight add-on base module with steel front panel and steel upper panel. W1100 mm. Electronically adjustable height.	B36000200011340
5.	Starter freestanding straight counter top with projection towards staff. D780 mm x W1900 mm.	B36002119380
6.	Starter left side free 60° curved counter top with projection on both sides. D900 mm.	B36002160470
7.	Add-on right side free straight counter top with projection on both sides. D900 mm x W1300 mm.	B36002113460
8.	Bag shelf. W1500 mm.	B360010153
9.	Drawer pedestal with lock, castors and 3 drawers.	B36600431
	Total	

DESIGN OPTIONS:

Base module:	BCI standard colour no. A29 Concertina grey texture*
Upper front panel:	BCI standard steel colours (for colours, see page 5)
Counter top:	BCI standard laminate #185 or linoleum #257
Drawer pedestal:	BCI standard colour no. A29 Concertina grey (for colours, see page 7)

*Other colours can be ordered at a surcharge per module of DKK 1.000.

CONCERTINA COUNTER

STRAIGHT BASE MODULES WITHOUT COUNTER TOPS - STEEL FRONT PANEL

A straight module with steel front panel and steel/perforated steel upper panel. When ordering an adjustable base module, it is necessary to mention whether it is a freestanding desk or whether it is followed by one or two add-ons.

Straight base module - with steel front panel and steel upper panel

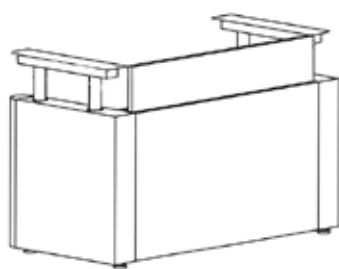

Width mm	Fixed/ Adjustable	Starter module Item no.	Add-on module Item no.
1100	Fixed	B36000107211340	B36000207211340
1100	Adjustable	B36000100011340	B36000200011340
1500	Fixed	B36000107215340	B36000207215340
1500	Adjustable	B36000100015340	B36000200015340

Straight base module - with steel front panel and perforated steel upper panel

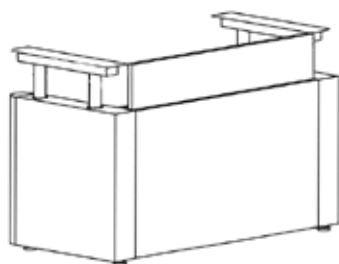

Module mm	Fixed/ Adjustable	Starter module Item no.	Add-on module Item no.
1100	Fixed	B36000107211350	B36000207211350
1100	Adjustable	B36000100011350	B36000200011350
1500	Fixed	B36000107215350	B36000207215350
1500	Adjustable	B36000100015350	B36000200015350

CONCERTINA COUNTER

CURVED BASE MODULES WITHOUT COUNTER TOPS - STEEL FRONT PANEL

A curved module with steel front panel and steel/perforated steel upper panel. When ordering an adjustable base module, it is necessary to mention whether it is a freestanding desk or whether it is followed by one or two add-ons. We do not recommend using 45° counters as freestanding due to minimal legroom between the end frames.

Curved base module - with steel front panel and steel upper panel

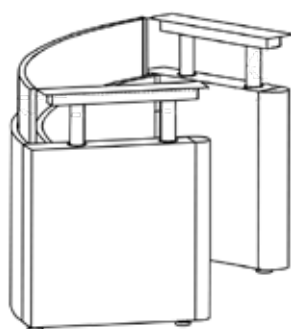

Curve	Fixed/ Adjustable	Starter module Item no.	Add-on module Item no.
45°	Fixed	B36000107245340	B36000207245340
45°	Adjustable	B36000100045340	B36000200045340
60°	Fixed	B36000107260340	B36000207260340
60°	Adjustable	B36000100060340	B36000200060340

Curved base module - with steel front panel and perforated steel upper panel

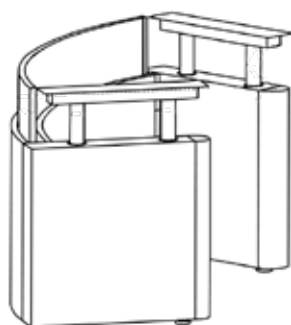

Curve	Fixed/ Adjustable	Starter module Item no.	Add-on module Item no.
45°	Fixed	B36000107245350	B36000207245350
45°	Adjustable	B36000100045350	B36000200045350
60°	Fixed	B36000107260350	B36000207260350
60°	Adjustable	B36000100060350	B36000200060350

CONCERTINA COUNTER

INTERMEDIATE MODULE - STEEL FRONT PANEL

The intermediate module is used when the counter top is wider than the base.

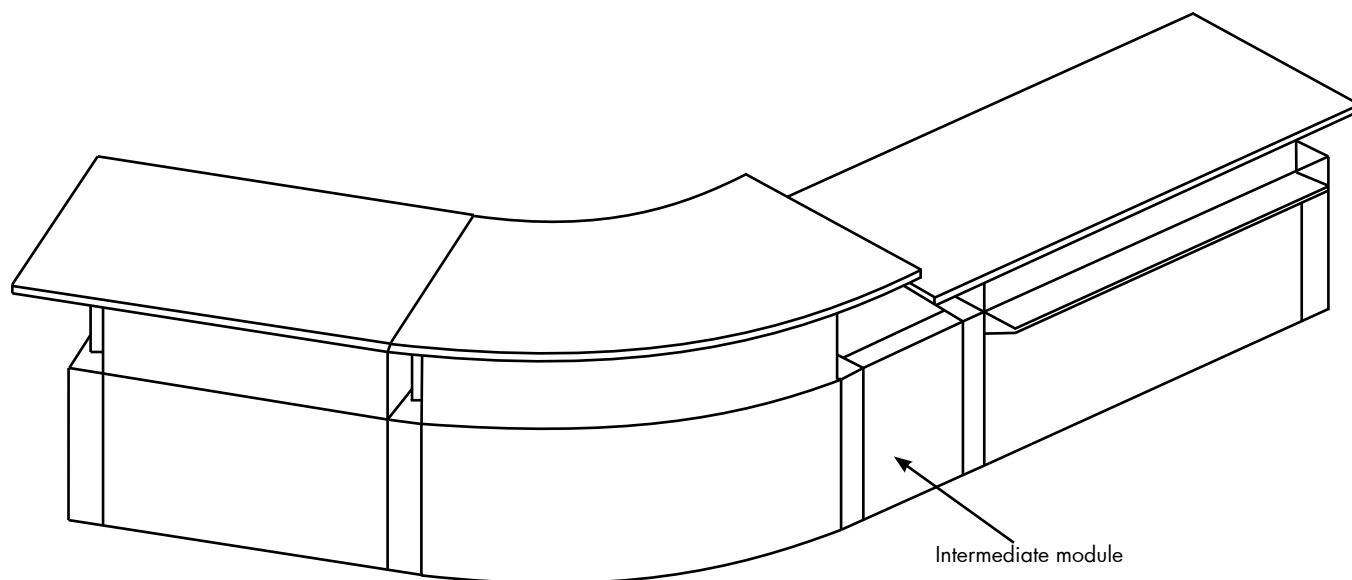

Intermediate module - with steel front panel

Width
mm

Item no.

440

B360009703

870

B360009873

CONCERTINA COUNTER

COUNTER TOPS FOR STRAIGHT BASE MODULE

The counter tops are available in four models; no projection, projection towards client, projection towards staff, and projection on both sides. Furthermore the counter tops are prepared for either freestanding, left side free, middle and right side free modules all depending on the position of the module. Note the construction of the Concertina counter is based on a left-to-right sequence (seen from the person's view sitting behind the counter).

No projection - depth 660 mm - for straight base module

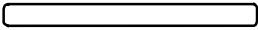
	Model	Width mm	Item no.
	Freestanding	1500	B36002115180
	Freestanding	1900	B36002119180
	Right side free	1300	B36002113160
	Right side free	1700	B36002117160
	Middle	1100	B36002111150
	Middle	1500	B36002115150
	Left side free	1300	B36002113170
	Left side free	1700	B36002117170

Projection towards client - depth 780 mm - for straight base module

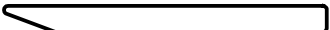
	Model	Width mm	Item no.
	Freestanding	1500	B36002115280
	Freestanding	1900	B36002119280
	Right side free	1300	B36002113260
	Right side free	1700	B36002117260
	Middle	1100	B36002111250
	Middle	1500	B36002115250
	Left side free	1300	B36002113270
	Left side free	1700	B36002117270

Projection towards staff - depth 780 mm - for straight base module

	Model	Width mm	Item no.
	Freestanding	1500	B36002115380
	Freestanding	1900	B36002119380
	Right side free	1300	B36002113360
	Right side free	1700	B36002117360
	Middle	1100	B36002111350
	Middle	1500	B36002115350
	Left side free	1300	B36002113370
	Left side free	1700	B36002117370

Projection on both sides - depth 900 mm - for straight base module

	Model	Width mm	Item no.
	Freestanding	1500	B36002115480
	Freestanding	1900	B36002119480
	Right side free	1300	B36002113460
	Right side free	1700	B36002117460
	Middle	1100	B36002111450
	Middle	1500	B36002115450
	Left side free	1300	B36002113470
	Left side free	1700	B36002117470

CONCERTINA COUNTER

COUNTER TOPS FOR 45° CURVED BASE MODULE

The counter tops are available in four models; no projection, projection towards client, projection towards staff, and projection on both sides. Furthermore the counter tops are prepared for either freestanding, left side free, middle and right side free modules all depending on the position of the module. Note the construction of the Concertina counter is based on a left-to-right sequence (seen from the person's view sitting behind the counter).

No projection - depth 660 mm - for 45° curved base module

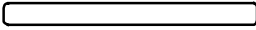
	Model	Item no.
	Freestanding	
	Right side free	B36002145160
	Middle	B36002145150
	Left side free	B36002145170

Projection towards client - depth 780 mm - for 45° curved base module

	Model	Item no.
	Freestanding	
	Right side free	B36002145260
	Middle	B36002145250
	Left side free	B36002145270

Projection towards staff - depth 780 mm - for 45° curved base module

	Model	Item no.
	Freestanding	
	Right side free	B36002145360
	Middle	B36002145350
	Left side free	B36002145370

Projection on both sides - depth 900 mm - for 45° curved base module

	Model	Item no.
	Freestanding	
	Right side free	B36002145460
	Middle	B36002145450
	Left side free	B36002145470

CONCERTINA COUNTER

COUNTER TOPS FOR 60° CURVED BASE MODULE

The counter tops are available in four models; no projection, projection towards client, projection towards staff, and projection on both sides. Furthermore the counter tops are prepared for either freestanding, left side free, middle and right side free modules all depending on the position of the module. Note the construction of the Concertina counter is based on a left-to-right sequence (seen from the person's view sitting behind the counter).

No projection - depth 660 mm - for 60° curved base module

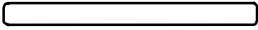
	Model	Item no.
	Freestanding	B36002160180
	Right side free	B36002160160
	Middle	B36002160150
	Left side free	B36002160170

Projection towards client - depth 780 mm - for 60° curved base module

	Model	Item no.
	Freestanding	B36002160280
	Right side free	B36002160260
	Middle	B36002160250
	Left side free	B36002160270

Projection towards staff - depth 780 mm - for 60° curved base module

	Model	Item no.
	Freestanding	B36002160380
	Right side free	B36002160360
	Middle	B36002160350
	Left side free	B36002160370

Projection on both sides - depth 900 mm - for 60° curved base module

	Model	Item no.
	Freestanding	B36002160480
	Right side free	B36002160460
	Middle	B36002160450
	Left side free	B36002160470

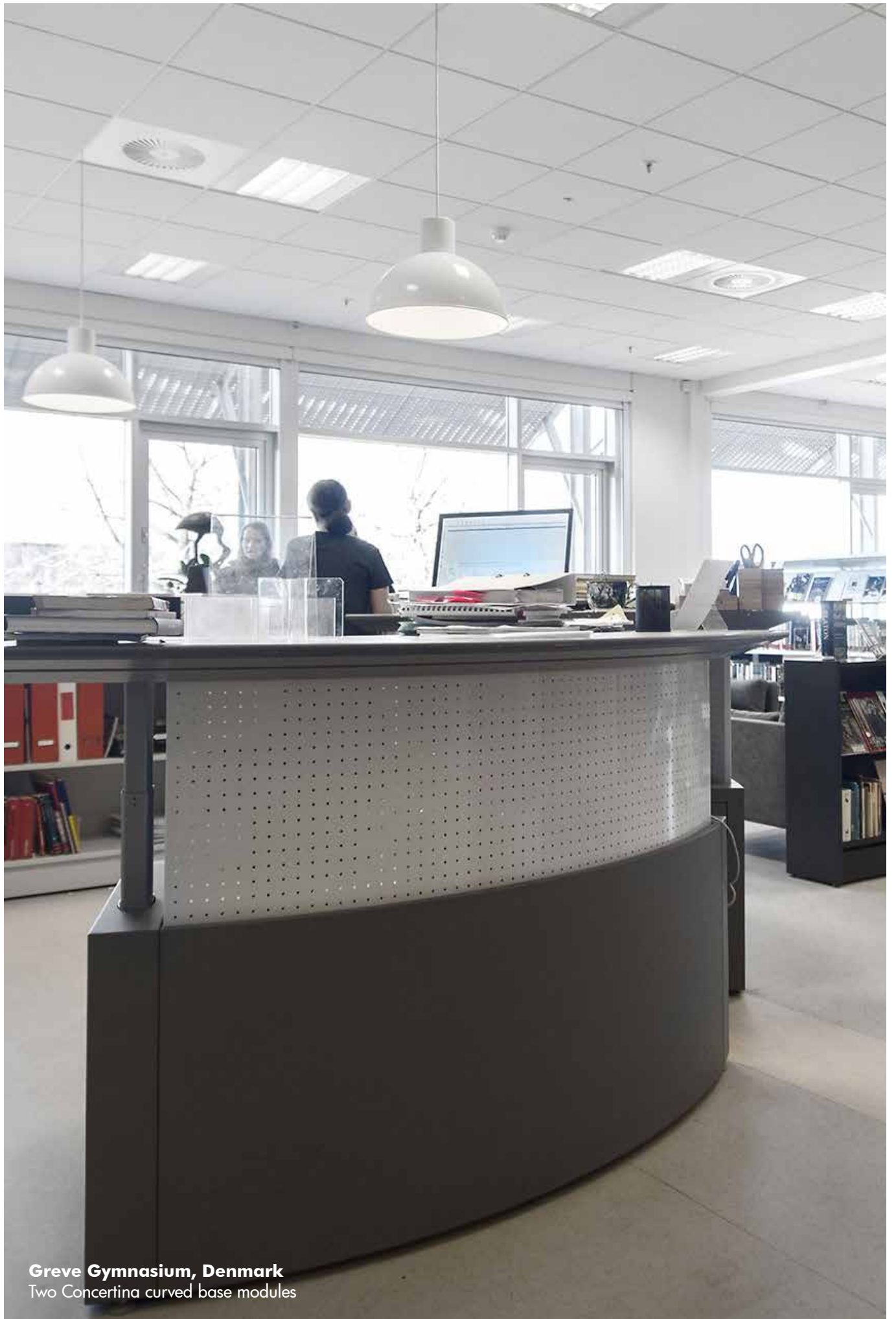

Greve Gymnasium, Denmark
Two Concertina curved base modules

CONCERTINA COUNTER

ACCESSORIES

Drawer pedestal with central lock and castors

Dimensions mm H x W x D	Drawers	Item no.
490 x 424 x 424	2	B36600421
490 x 424 x 424	3	B36600431

Shelf pedestal

Dimensions mm H x W x D	With/without castors	Shelves	Item no.
490 x 424 x 424	With	1	B36600111
490 x 424 x 424	With	2	B36600121
425 x 424 x 424	Without	1	B36600110
425 x 424 x 424	Without	2	B36600120

Base for shelf pedestal without castors

Item no.

B366010

Bag shelf

Incl. brackets

For base module

For steel front
Item no.

1100 mm straight counter	B360010113
1500 mm straight counter	B360010153
45° curved counter	B360010453
60° curved counter	B360010603

LOCATIONS

WE ARE LIBRARY PEOPLE®



DENMARK

Lammhults Biblioteksdesign A/S
Dalbækvej 1
6670 Holsted

bci@bci.dk
www.bci.dk

FRANCE

BC Intérieur Sarl
6 allée Kepler
77420 Champs sur Marne

bci@bcinterieur.com
www.bcinterieur.com

BELGIUM

SBNL - Schulz Benelux BVBA
Appelweg 94 C
3221 Holsbeek

info@sbnl.be
www.sbnl.be

SWEDEN

Lammhults Biblioteksdesign AB
Odlarevägen 16
226 60 Lund

eurobib@eurobib.se
www.eurobib.se

GERMANY

Schulz Speyer Bibliothekstechnik AG
Hafenstraße 2
67346 Speyer

sales@schulzspeyer.de
www.schulzspeyer.de

UNITED KINGDOM

thedesignconcept Ltd.
The Old Bakery,
10 Greenless Road
Cambuslang Belgrave Street
Glasgow G72 8JJ

info@thedesignconcept.co.uk
www.thedesignconcept.co.uk

NORWAY

BS Eurobib AS
Alf Bjerckes Vei 20
0582 Oslo

post@bseurobib.no
www.bseurobib.no